



Pages 1 to 15

DIODES, POWER RECTIFIER, SCHOTTKY BARRIER

BASED ON TYPE STPS20100

ESCC Detail Specification No. 5106/016

Issue 4	October 2009
---------	--------------



Document Custodian: European Space Agency - see <https://escies.org>

LEGAL DISCLAIMER AND COPYRIGHT

European Space Agency, Copyright © 2009. All rights reserved.

The European Space Agency disclaims any liability or responsibility, to any person or entity, with respect to any loss or damage caused, or alleged to be caused, directly or indirectly by the use and application of this ESCC publication.

This publication, without the prior permission of the European Space Agency and provided that it is not used for a commercial purpose, may be:

- copied in whole, in any medium, without alteration or modification.
- copied in part, in any medium, provided that the ESCC document identification, comprising the ESCC symbol, document number and document issue, is removed.

DOCUMENTATION CHANGE NOTICE

(Refer to <https://escies.org> for ESCC DCR content)

DCR No.	CHANGE DESCRIPTION
447	Specification up issued to incorporate technical changes per DCR.

TABLE OF CONTENTS

1.	<u>GENERAL</u>	5
1.1	Scope	5
1.2	Applicable Documents	5
1.3	Terms, Definitions, Abbreviations, Symbols and Units	5
1.4	The ESCC Component Number and Component Type Variants	5
1.4.1	The ESCC Component Number	5
1.4.2	Component Type Variants	5
1.5	Maximum Ratings	6
1.6	Handling Precautions	7
1.7	Physical Dimensions and Terminal Identification	7
1.7.1	Metal Flange Mount Package (TO-254) - 3 lead	7
1.7.2	Surface Mount Package (SMD.5) - 3 terminal	8
1.7.3	Surface Mount Package (SMD1) - 3 terminal	9
1.7.4	Notes to Physical Dimensions and Terminal Identification	9
1.8	Functional Diagram	10
1.9	Materials and Finishes	11
2.	<u>REQUIREMENTS</u>	11
2.1	General	11
2.1.1	Deviations from the Generic Specification	11
2.1.1.1	Deviation from Screening Tests - Chart F3	11
2.1.1.2	Deviations from Qualification and Periodic Tests - Chart F4	11
2.2	Marking	11
2.3	Terminal Strength	11
2.4	Electrical Measurements at Room, High and Low Temperatures	12
2.4.1	Room Temperature Electrical Measurements	12
2.4.2	High and Low Temperatures Electrical Measurements	12
2.4.3	Notes to Electrical Measurement Tables	13
2.5	Parameter Drift Values	13
2.6	Intermediate and End-Point Electrical Measurements	13
2.7	Power Burn-in Conditions	14
2.8	Operating Life Conditions	14
	APPENDIX 'A'	15

1. GENERAL

1.1 SCOPE

This specification details the ratings, physical and electrical characteristics and test and inspection data for the component type variants and/or the range of components specified below. It supplements the requirements of, and shall be read in conjunction with, the ESCC Generic Specification listed under Applicable Documents.

1.2 APPLICABLE DOCUMENTS

The following documents form part of this specification and shall be read in conjunction with it:

- (a) ESCC Generic Specification No. 5000
- (b) MIL-STD-750, Test Methods and Procedures for Semiconductor Devices

1.3 TERMS, DEFINITIONS, ABBREVIATIONS, SYMBOLS AND UNITS

For the purpose of this specification, the terms, definitions, abbreviations, symbols and units specified in ESCC Basic Specification No. 21300 shall apply.

1.4 THE ESCC COMPONENT NUMBER AND COMPONENT TYPE VARIANTS

1.4.1 The ESCC Component Number

The ESCC Component Number shall be constituted as follows:

Example: 510601601

- Detail Specification Reference: 5106016
- Component Type Variant Number: 01 (as required)

1.4.2 Component Type Variants

The component type variants applicable to this specification are as follows:

Variant Number	Based on Type	Case	Description	Lead/Terminal Material and Finish	Weight max g
01	STPS20100	TO-254	Single diode	H9	10
02	STPS20100	TO-254	Dual diode, common anode	H9	10
03	STPS20100	TO-254	Dual diode, common cathode	H9	10
04	STPS20100	TO-254	Dual diode, series, centre tapped	H9	10

Variant Number	Based on Type	Case	Description	Lead/Terminal Material and Finish	Weight max g
05	STPS20100	SMD.5	Single diode	Q14	2
06	STPS20100	SMD1	Single diode	Q14	3
07	STPS20100	SMD1	Dual diode, common cathode	Q14	3

The lead/terminal material and finish shall be in accordance with the requirements of ESCC Basic Specification No. 23500.

1.5 MAXIMUM RATINGS

The maximum ratings shall not be exceeded at any time during use or storage.

Maximum ratings shall only be exceeded during testing to the extent specified in this specification and when stipulated in Test Methods and Procedures of the ESCC Generic Specification.

Characteristics	Symbols	Maximum Ratings	Unit	Remarks
Forward Surge Current (per Diode)	I_{FSM}	250	A	Note 1
Repetitive Peak Reverse Voltage	V_{RRM}	100	V	Note 2
Repetitive Peak Reverse Current	I_{RRM}	1	A	Note 3
Average Output Rectified Current	I_O		A	50% duty cycle Notes 4, 9
All Variants (per Diode)		20		
Variants 02, 03 and 07 (per Device)		40		
RMS Forward Current (Per Diode)	$I_{F(rms)}$	30	A	
Operating Temperature Range (Case Temperature)	T_{op}	-65 to +175	°C	Note 5
Junction Temperature	T_J	+175	°C	
Storage Temperature Range	T_{stg}	-65 to +175	°C	Note 5
Soldering Temperature	T_{sol}		°C	
For TO-254		+260		Note 6
For SMD.5 and SMD1		+245		Note 7
Critical Rate of Rise of Reverse Voltage	dV/dt	10000	V/μs	
Thermal Resistance, Junction to Case	$R_{th(j-c)}$		°C/W	Notes 8, 9
Variants 01, 05 and 06		1.65		
Variants 02 to 04 and 07 (per Diode)		1.65		
Variants 02, 03 and 07 (per Device)		0.85		

NOTES:

1. Sinusoidal pulse of 10ms duration.
2. Pulsed, duration 5ms, $f = 50\text{Hz}$.
3. Pulsed, duration $2\mu\text{s}$, $f = 1\text{kHz}$.
4. For $T_{\text{case}} > +140^{\circ}\text{C}$, derate linearly to 0A at $+175^{\circ}\text{C}$.
5. For Variants with hot solder dip lead finish all testing performed at $T_{\text{amb}} > +125^{\circ}\text{C}$ shall be carried out in a 100% inert atmosphere.
6. Duration 10 seconds maximum at a distance of not less than 1.5mm from the device body and the same lead shall not be resoldered until 3 minutes have elapsed.
7. Duration 5 seconds maximum and the same package shall not be resoldered until 3 minutes have elapsed.
8. Package mounted on infinite heatsink.
9. The "per Device" ratings apply only as follows:-
 Variants 02: when both cathode terminals are tied together.
 Variants 03 and 07: when both anode terminals are tied together.

1.6 HANDLING PRECAUTIONS

The TO-254 package contains Beryllium Oxide (BeO) and therefore it must not be ground, machined, sandblasted or subjected to any mechanical operation which will produce dust. The case must not be subjected to any chemical process (e.g. etching) which will produce fumes.

1.7 PHYSICAL DIMENSIONS AND TERMINAL IDENTIFICATION

Consolidated Notes are given following the case drawings and dimensions.

1.7.1 Metal Flange Mount Package (TO-254) - 3 lead

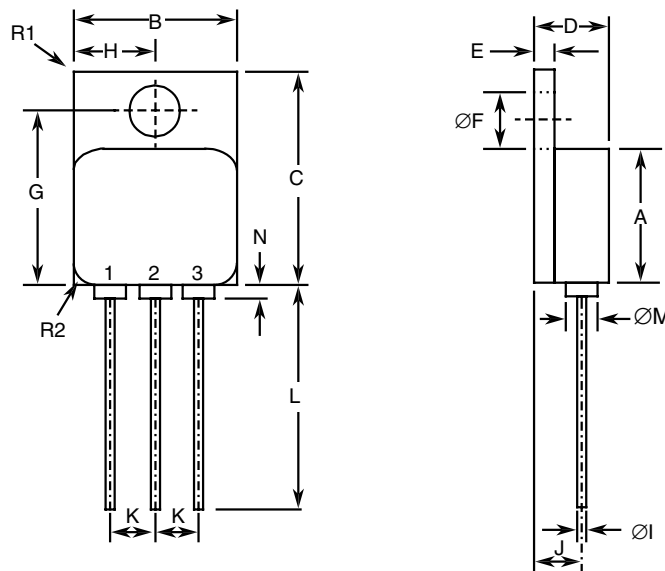

Symbols	Dimensions mm		Notes
	Min	Max	
A	13.59	13.84	
B	13.59	13.84	

Symbols	Dimensions mm		Notes
	Min	Max	
C	20.07	20.32	
D	6.3	6.7	
E	1	1.35	
ØF	3.5	3.9	
G	16.89	17.4	
H	6.86 BSC		
ØI	0.89	1.14	2
J	3.81 BSC		
K	3.81 BSC		
L	12.95	14.5	
ØM	3.05 Typical		2
N	-	0.71	2
R1	-	1	3
R2	1.65 Typical		4

1.7.2 Surface Mount Package (SMD.5) - 3 terminal

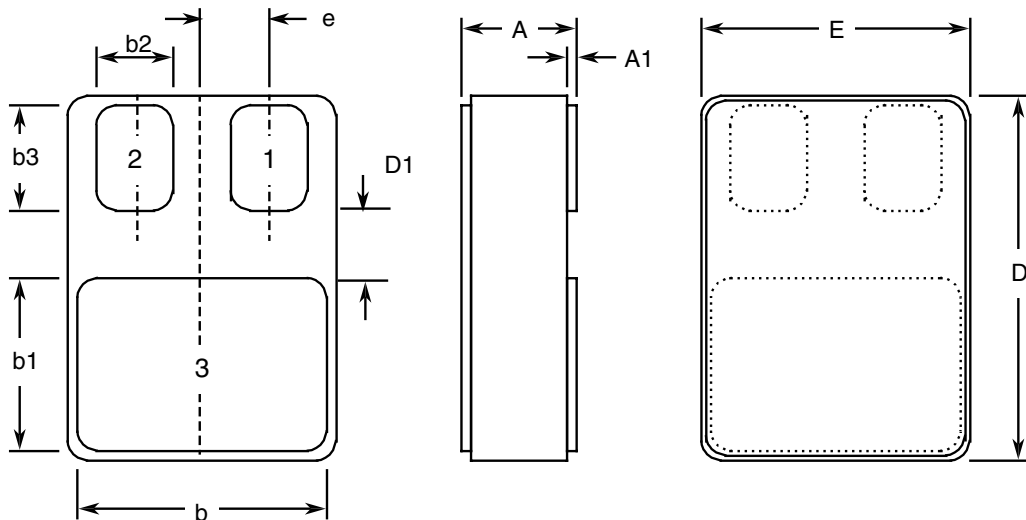

Symbols	Dimensions mm		Notes
	Min	Max	
A	2.84	3.15	
A1	0.25	0.51	
b	7.13	7.39	
b1	5.58	5.84	

Symbols	Dimensions mm		Notes
	Min	Max	
b2	2.28	2.54	5
b3	2.92	3.18	5
D	10.03	10.28	
D1	0.76	-	5
E	7.39	7.64	
e	1.91 BSC		5

1.7.3 Surface Mount Package (SMD1) - 3 terminal

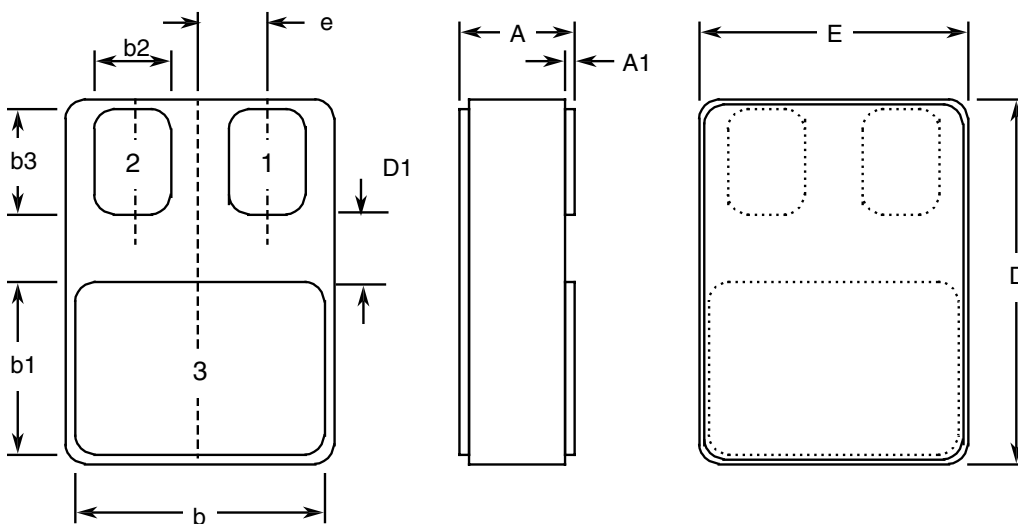

Symbols	Dimensions mm		Notes
	Min	Max	
A	3.3	3.61	
A1	0.25	0.51	
b	9.4	9.65	
b1	10.41	10.67	
b2	3.43	3.68	5
b3	3.86	4.11	5
D	15.75	16	
D1	0.76	-	5
E	11.3	11.56	
e	2.67 BSC		5

1.7.4 Notes to Physical Dimensions and Terminal Identification

1. The terminal identification is specified by the component's geometry. See Functional Diagram for

the terminal connections.

2. 3 places.
3. Radius of heatsink flange corner, 4 places.
4. Radius of body corner, 4 places.
5. 2 places.

1.8 FUNCTIONAL DIAGRAM

Variant 01

Terminal 1: Cathode
Terminal 2: No connection
Terminal 3: Anode



Variant 02

Terminal 1: Cathode a
Terminal 2: Common Anode
Terminal 3: Cathode b

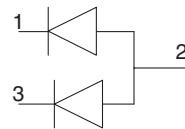

Variant 03

Terminal 1: Anode a
Terminal 2: Common Cathode
Terminal 3: Anode b

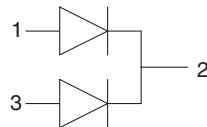

Variant 04

Terminal 1: Anode a
Terminal 2: Centre Tap
Terminal 3: Cathode b

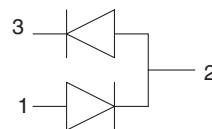

Variants 05 and 06

Terminals 1 and 2: Anode
Terminal 3: Cathode

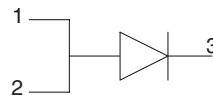

Variant 07

Terminal 1: Anode a
Terminal 2: Anode b
Terminal 3: Common Cathode

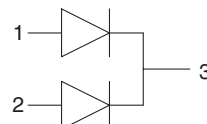

NOTES:

1. For TO-254, the case is not connected to any lead.
2. For SMD.5 and SMD1, the lid is not connected to any terminal.

1.9 MATERIALS AND FINISHES

Materials and finishes shall be as follows:

- a) Case
For the metal flange mount package the case shall be hermetically sealed and have a metal body. The leads pass through ceramic eyelets brazed into the frame and the lid shall be welded.
For the surface mount packages the case shall be hermetically sealed and have a ceramic body with a Kovar lid.
- b) Leads/Terminals
As specified in Component Type Variants.

2. REQUIREMENTS**2.1 GENERAL**

The complete requirements for procurement of the components specified herein are as stated in this specification and the ESCC Generic Specification. Permitted deviations from the Generic Specification, applicable to this specification only, are listed below.

Permitted deviations from the Generic Specification and this Detail Specification, formally agreed with specific Manufacturers on the basis that the alternative requirements are equivalent to the ESCC requirement and do not affect the component's reliability, are listed in the appendices attached to this specification.

2.1.1 Deviations from the Generic Specification**2.1.1.1 Deviation from Screening Tests - Chart F3**

- (a) High Temperature Reverse Bias Burn-in and the subsequent Final Measurements for HTRB shall be omitted.

2.1.1.2 Deviations from Qualification and Periodic Tests - Chart F4

- (a) Constant Acceleration is not applicable.
- (b) For SMD.5 and SMD1, Terminal Strength is not applicable.

2.2 MARKING

The marking shall be in accordance with the requirements of ESCC Basic Specification No. 21700 and as follows.

The information to be marked on the component shall be:

- (a) The ESCC qualified components symbol (for ESCC qualified components only).

- (b) The ESCC Component Number.
- (c) Traceability information.
- (d) Warning sign for Beryllium Oxide (TO-254 only).

2.3 TERMINAL STRENGTH

The test conditions for Terminal Strength, tested as specified in the ESCC Generic Specification, shall be as follows:

For TO-254, Test Condition: A, tension, with an applied force of 10N and a duration of 10s.

2.4 ELECTRICAL MEASUREMENTS AT ROOM, HIGH AND LOW TEMPERATURES

Electrical measurements shall be performed at room, high and low temperatures. Consolidated notes are given after the tables.

2.4.1 Room Temperature Electrical Measurements

The measurements shall be performed at $T_{amb}=+22 \pm 3^{\circ}C$.

Characteristics	Symbols	MIL-STD-750 Test Method	Test Conditions Note 1	Limits		Units
				Min	Max	
Reverse Current	I_R	4016	DC Method $V_R = 100V$	-	30	μA
Forward Voltage	V_{F1}	4011	Pulse Method $I_F = 10A$ Note 2	-	780	mV
	V_{F2}	4011	Pulse Method $I_F = 20A$ Note 2	-	1	V
Capacitance	C	4001	$V_R = 10V$ $f = 1MHz$	-	700	pF
Thermal Impedance, Junction to Case	$Z_{th(j-c)}$	3101	$I_H = 15$ to $40A$ $t_H = 50ms$ $I_M = 50mA$ $t_{md} = 100\mu s$ Note 3	(Calculate ΔV_F , see Note 4)		$^{\circ}C/W$

2.4.2 High and Low Temperatures Electrical Measurements

Characteristics	Symbols	MIL-STD-750 Test Method	Test Conditions Notes 1 and 5	Limits		Units
				Min	Max	
Reverse Current	I_R	4016	$T_{case}=+125(+0-5)^{\circ}C$ DC Method $V_R=100V$	-	20	mA

Characteristics	Symbols	MIL-STD-750 Test Method	Test Conditions Notes 1 and 5	Limits		Units
				Min	Max	
Forward Voltage 2	V _{F2}	4011	T _{case} =+125(+0-5) ^o C Pulse Method I _F =20A Note 2	-	900	mV
			T _{case} =-55(+5 -0) ^o C Pulse Method I _F =20A Note 2	-	1.1	V

2.4.3 Notes to Electrical Measurement Tables

1. Measurement per each diode.
2. Pulse Width ≤300μs, Duty Cycle ≤2%.
3. Performed only during Screening Tests Parameter Drift Values (Initial Measurements), go-no-go.
4. The limits for ΔV_F shall be defined by the Manufacturer on every lot in accordance with MIL-STD-750 Method 3101 and shall guarantee the R_{th(j-c)} limits specified in Maximum Ratings.
5. Read and record measurements shall be performed on a sample of 5 components with 0 failures allowed. Alternatively a 100% inspection may be performed.

2.5 PARAMETER DRIFT VALUES

Unless otherwise specified, the measurements shall be performed at T_{amb}=+22 ±3^oC.

The test methods and test conditions shall be as per the corresponding test defined in Room Temperature Electrical Measurements.

The drift values (Δ) shall not be exceeded for each characteristic specified. The corresponding absolute limit values for each characteristic shall not be exceeded.

Characteristics	Symbols	Limits			Units
		Drift Value Δ	Absolute		
			Min	Max	
Reverse Current	I _R	±4 or (1) ±100%	-	30	μA
Forward Voltage 1	V _{F1}	±10	-	780	mV

NOTES:

1. Whichever is the greater referred to the initial value.

2.6 INTERMEDIATE AND END-POINT ELECTRICAL MEASUREMENTS

Unless otherwise specified, the measurements shall be performed at T_{amb}=+22 ±3^oC.

The test methods and test conditions shall be as per the corresponding test defined in Room

Temperature Electrical Measurements.

The limit values for each characteristic shall not be exceeded.

Characteristics	Symbols	Limits		Units
		Min	Max	
Reverse Current	I_R	-	30	μA
Forward Voltage 1	V_{F1}	-	780	mV

2.7 POWER BURN-IN CONDITIONS

Characteristics	Symbols	Test Conditions	Units
Case Temperature	T_{case}	+125	$^{\circ}C$
Reverse Voltage	V_R	80	V

2.8 OPERATING LIFE CONDITIONS

The conditions shall be as specified for Power Burn-in.

APPENDIX 'A'**AGREED DEVIATIONS FOR STMICROELECTRONICS (F)**

ITEMS AFFECTED	DESCRIPTION OF DEVIATIONS
Deviations from Production Control - Chart F2	Special In-Process Controls - Internal Visual Inspection. Wedge bonds equal to 1.1 wire diameter are acceptable for bonding with a V-Groove tool.
Deviations from Screening Tests - Chart F3	Solderability is not applicable unless specifically stipulated in the Purchase Order.