



Pages 1 to 20

**CRYSTAL UNITS IN METAL HOLDER,
BASED ON TYPE T1507,
FREQUENCY RANGE 2.5 - 50MHZ**

ESCC Detail Specification No. 3501/019

**(Follow-up Specification to ESCC Detail Specification Nos. 3501/002 and
3501/009)**

ISSUE 4

November 2010



Document Custodian: European Space Agency - see <https://escies.org>

	ESCC Detail Specification No. 3501/019		PAGE i ISSUE 4
---	---	--	-------------------

LEGAL DISCLAIMER AND COPYRIGHT

European Space Agency, Copyright © 2010. All rights reserved.

The European Space Agency disclaims any liability or responsibility, to any person or entity, with respect to any loss or damage caused, or alleged to be caused, directly or indirectly by the use and application of this ESCC publication.

This publication, without the prior permission of the European Space Agency and provided that it is not used for a commercial purpose, may be:

- copied in whole in any medium without alteration or modification.
- copied in part, in any medium, provided that the ESCC document identification, comprising the ESCC symbol, document number and document issue, is removed.

	<p>ESCC Detail Specification No. 3501/019</p>		<p>PAGE 2 ISSUE 4</p>
---	---	--	---------------------------

DOCUMENTATION CHANGE NOTICE

(Refer to <https://escies.org> for ESCC DCR content)

DCR No.	CHANGE DESCRIPTION
582	Specification upissued to incorporate technical changes per DCR.



TABLE OF CONTENTS

	<u>Page</u>
1. <u>GENERAL</u>	5
1.1 Scope	5
1.2 Range of Components	5
1.3 Maximum Ratings	5
1.4 Physical Dimensions	5
1.5 Functional Diagram	5
2. <u>APPLICABLE DOCUMENTS</u>	5
3. <u>TERMS, DEFINITIONS, ABBREVIATIONS, SYMBOLS AND UNITS</u>	5
4. <u>REQUIREMENTS</u>	11
4.1 General	11
4.2 Deviations from Generic Specification	11
4.2.1 Deviations from Special In-process Controls	11
4.2.2 Deviations from Final Production Tests	11
4.2.3 Deviations from Burn-in Tests	11
4.2.4 Deviations from Qualification Tests	11
4.2.5 Deviations from Lot Acceptance Tests	11
4.3 Mechanical Requirements	11
4.3.1 Dimension Check	11
4.3.2 Weight	11
4.3.3 Robustness of Terminations	11
4.4 Materials and Finishes	11
4.4.1 Case	12
4.4.2 Lead Material and Finish	12
4.5 Marking	12
4.5.1 General	12
4.5.2 Characteristics	12
4.5.3 Traceability Information	12
4.5.4 The ESCC Component Number,	12
4.5.5 Manufacturer's Name, Symbol and Code	13
4.6 Electrical Measurements	13
4.6.1 Electrical Measurements at Reference Temperature	13
4.6.2 Electrical Measurements at High and Low Temperatures	13
4.6.3 Circuits for Electrical Measurements	13
4.7 Burn-in Tests	13
4.7.1 Parameter Drift Values	13
4.7.2 Conditions for Burn-in	13
4.7.3 Electrical Circuits for Burn-in	13
4.8 Environmental and Endurance Tests	15
4.8.1 Measurements and Inspections on Completion of Environmental Tests	15
4.8.2 Measurements and Inspections at Intermediate Points and on Completion of Endurance Tests	15
4.8.3 Conditions for Operating Life Test	15

	<p style="text-align: center;">ESCC Detail Specification No. 3501/019</p>	<p>PAGE 4 ISSUE 4</p>
--	---	---------------------------

Page

TABLES

1(a)	Format for Individual Tables 1(a)	6
1(b)	Maximum Ratings	9
2	Electrical Measurements at Reference Temperature	14
3	Electrical Measurements at High and Low Temperatures	14
4	Parameter Drift Values	15
5	Conditions for Burn-in and LAT Life Tests	15
6	Measurements and Inspections on Completion of Environmental Tests and at Intermediate Points and on Completion of Endurance Testing	16

FIGURES

1	Parameter Derating Information	N/A
2	Physical Dimensions	10
3	Functional Diagram	10
4	Circuits for Electrical Measurements	N/A
5	Electrical Circuit for Burn-in and Life Test	N/A

APPENDICES (Applicable to specific Manufacturers only)

A	RAKON (F)	19
B	KVG Quartz Crystal Technology GmbH (D)	20

1. GENERAL

1.1 SCOPE

This specification details the values, physical and electrical characteristics, test and inspection data for Crystal Units in Metal Holder, based on Type T1507, Frequency Range 2.5 - 50MHz.

It shall be read in conjunction with ESCC Generic Specification No. 3501, the requirements for which are supplemented herein.

This is a follow-up specification to ESCC Detail Specification Nos. 3501/002 and 3501/009 which should be consulted by:-

- (a) Users seeking information concerning the availability of variants previously ordered to these specifications.
- (b) Manufacturers before introducing a new specific crystal identification as outlined in Para. 1.2.

1.2 RANGE OF COMPONENTS

The specific characteristics shall be negotiated between the Manufacturer and the Orderer on the basis of Table 1(a).

The contents of the individual tables shall relate to the design parameters of individual crystal units, optimised for the intended application.

The agreed table shall be held under configuration control by the Manufacturer who will allocate a specific crystal identification number sequentially when a request for a crystal is received.

1.3 MAXIMUM RATINGS

The maximum ratings, which shall not be exceeded at any time during use or storage, applicable to the crystal units specified herein, are as scheduled in Table 1(b).

1.4 PHYSICAL DIMENSIONS

The physical dimensions of the crystal units specified herein are shown in Figure 2.

1.5 FUNCTIONAL DIAGRAM

The functional diagram showing lead identification of the crystal units specified herein is shown in Figure 3.

2. APPLICABLE DOCUMENTS

The following documents form part of this specification and shall be read in conjunction with it:-

- (a) ESCC Generic Specification No. 3501 for Quartz Crystal Units.

3. TERMS, DEFINITIONS, ABBREVIATIONS, SYMBOLS AND UNITS

For the purpose of this specification, the terms, definitions, abbreviations, symbols and units specified in ESCC Basic Specification No. 21300 shall apply. In addition, the following symbols are used:-

Resonance Frequency	= f_r	Static Capacitance	= C_0
Load Resonance Frequency	= f_L	Load Capacitance	= C_L
Reference Temperature	= T_0	Motional Capacitance	= C_1
Turning Point Temperature	= T_{TP}	Motional Inductance	= L_1
Resonance Resistance	= R_r	Response Resistance	= R_p
Load Resonance Resistance	= R_L	Response Impedance	= $ Z_{pi} $
Rated Drive Level	= P_0	Insulation Resistance	= R_i

TABLE 1(a) - FORMAT FOR INDIVIDUAL TABLES 1(a)
SPECIFIC CRYSTAL IDENTIFICATION NUMBER - _____

No.	Characteristic	Symbol	Limits		Unit	Remarks
			Min.	Max.		
1	Resonance Frequency	f_r or f_L			MHz	Note 1
2	Reference Temperature	T_o			°C	Note 2
3	Turning Point Temperature	T_{TP}			°C	Note 3
4	Overtone Order	-				
5	Load Capacitance	C_L			pF	Note 4
6	Rated Drive Level	P_o			mW	Note 5
7	Frequency Adjustment Tolerance	$\frac{\Delta f}{f}$			10^{-6}	At T_o °C Note 6
8	Resonance Resistance	R_r or R_L			Ω	At T_o °C Note 7
9	Frequency Variation with Temperature over T_{op}	$\frac{\Delta f}{f}$			10^{-9}	From frequency measured at T_o °C Note 8
10	Resistance Variation with Temperature over T_{op}	$\frac{\Delta R}{R}$			%	From resistance measured at T_o °C Note 8
11	Operating Temperature Range	T_{op}			°C	
12	Frequency Variation with Drive Level	$\frac{\Delta f}{f}$			10^{-6}	From $P_{S1} =$ mW to $P_{S2} =$ mW Note 9
13	Resistance Variation with Drive Level	$\frac{\Delta R}{R}$			%	From $P_{S1} =$ mW to $P_{S2} =$ mW Note 9
14	Motional Inductance	L_1			mH	Notes 10 and 11
15	Motional Capacitance	C_1			fF	Note 10
16	Static Capacitance	C_o			pF	Note 10
17	Q Factor	Q			-	Notes 10 and 12
18	Ratio of Unwanted: Response Resistance to Resonance Resistance or Response Impedance to Resonance Resistance	R_p/R or $ Z_p /R$				In the frequency range: $f -$ kHz to $f +$ kHz Note 13
19	Ageing	$\frac{\Delta f}{f}$			10^{-6}	Note 14
20	Physical Dimensions					Note 15
21	Intended Application					Note 16

NOTES: See Pages 7 and 8.

NOTES TO TABLE 1(a)1. Resonance Frequency f_r or f_L (a) If C_L is not specified, Symbol and measurement shall be f_r .(b) If C_L is specified, Symbol and measurement shall be f_L .2. Reference Temperature T_0 (a) For a crystal unit functioning in a non-controlled temperature environment, the reference temperature is normally $+25 \pm 2$ °C.3. Turning Point Temperature T_{TP}

(a) For a crystal unit functioning in a temperature controlled environment (OCXO), the turning point temperature shall be within the limits specified for the reference temperature range.

(b) To be specified for OCXO crystal units in addition to the reference temperature.

4. Load Capacitance C_L (a) When a crystal unit must function at its series resonance frequency, C_L shall be infinite.(b) When a crystal unit must function with a load capacitance, the C_L value shall be specified.

(c) When a crystal unit must function with an adjustable load capacitance, the minimum and maximum limits shall be specified.

N.B.The tolerance on the load capacitance shall be that value which results in a frequency change not exceeding 10% of the frequency tolerance at T_0 or 1% of the nominal load capacitance, whichever is smaller.5. Rated Drive Level P_0

The rated drive level shall be selected from the standard drive levels specified below:

- 0.25mW, 0.2mW, 0.1mW, 0.05mW, 0.02mW and 0.01mW at $\pm 20\%$.6. Frequency Adjustment Tolerance(a) When a crystal unit must function at its series resonance frequency, the resonance frequency measured at T_0 shall be within the tolerance specified. The standard value of the adjustment tolerance shall be $\pm 10 \times 10^{-6}$.(b) When a crystal unit has to function with a fixed load capacitance, the resonance frequency measured with this load at T_0 shall be within the tolerance specified. The standard value of the adjustment tolerance shall be $\pm 10 \times 10^{-6}$.(c) When a crystal unit is required to operate with an adjustable load capacitance with the limits indicated in Item 5 of the Table, the resonance frequency shall be adjustable to its correct T_0 value so the frequency adjustment tolerance does not need to be specified.7. Resonance Resistance

(a) Generally, the maximum value only is specified.

(b) R_L may be calculated by $R_L = R_r \left(1 + \frac{C_0}{C_L} \right)^2$.8. Frequency and Resistance Variation with Temperature

These values shall be specified such that they are consistent with the operating temperature range.

	<p style="text-align: center;">ESCC Detail Specification No. 3501/019</p>		<p>PAGE 8 ISSUE 4</p>
--	---	--	---------------------------

NOTES TO TABLE 1(a) (Continued)

9. Frequency and Resistance Variation with Drive Level

These limits and the Drive Level range (P_{S1} to P_{S2}) shall be specified for very special crystals only (i.e. crystals used in very high stability oscillators).

10. Electrical Values

The electrical values shall be specified only when required for the correct functioning of the equipment in which the crystal is used.

11. Motional Inductance L_1

Because the inductance value may be restricted by other chosen parameters, the Manufacturer shall propose the value of L_1 in accordance with the Customer's requirements.

12. 'Q' Factor

If 'R' and 'L' have been already specified, it will not be necessary to specify the minimum value of the 'Q' factor.

The maximum value of the 'Q' factor is never specified.

13. Ratio of Unwanted Response Resistance to Resonance Resistance

The standard minimum value is 2, but it is possible to obtain higher values.

The frequency range within which the minimum value of the ratio is required shall also be specified.

14. Ageing

Specify limits under appropriate column and ageing period under "Remarks".

15. Physical Dimensions

The applicable Figure Number is to be specified.

16. Intended Application

For definitions of the selected symbol to be added, see ESCC Generic Specification No. 3501, Para. 3.

17. Not Applicable Items

For all items where limits are not specified, "Not applicable" shall be entered in the Limits column.

TABLE 1(b) - MAXIMUM RATINGS

No.	Characteristic	Symbol	Values	Unit	Remarks
1	Nominal Frequency Range	f	2.5 to 20	MHz	Note 1
2	Drive Level Range	P	0.01 to 0.2	mW	Note 1
3	Operating Temperature Range	T _{op}	-	°C	Note 2
4	Storage Temperature Range	T _{stg}	-65 to +125	°C	Note 3
5	Soldering Temperature	T _{sol}	+260	°C	Note 4

NOTES

1.

Fundamental and Overtone Order	Approx. Frequency Range (MHz)	Drive Level Range (mW)
Fundamental	2.5 to 20	0.05 to 0.2
3	10 to 30	0.05 to 0.25
5	15 to 50	0.05 to 0.25

In use, the rated drive level shall not be exceeded.

2. See Tables 1(a).
3. The duration at maximum storage temperature shall not exceed 16 hours.
4. Duration 10 seconds maximum at a distance of not less than 3.0mm from the device body and the same lead shall not be resoldered until 3 minutes have elapsed.

FIGURE 1 - PARAMETER DERATING INFORMATION

Not applicable.

FIGURE 2 - PHYSICAL DIMENSIONS

SYMBOL	MILLIMETRES		REMARKS
	MIN.	MAX.	
∅A	-	15.75	
C	-	6.80	
H	6.90	7.40	Pitch 7.16mm
∅K	0.40	0.48	
L	12.70	-	
P	-	0.90	Note 2
Q	-	0.95	Note 2

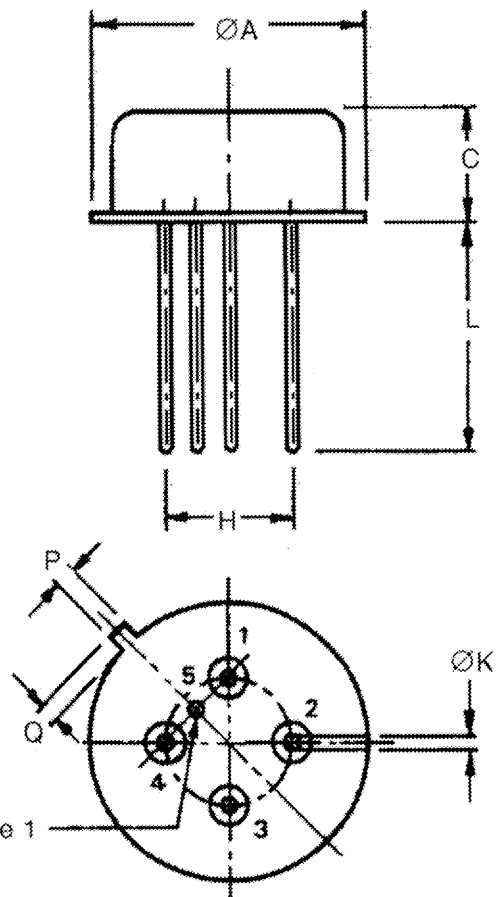

NOTES

1. Lead No. 5 is grounded to case.
2. The tag's position or presence is optional.

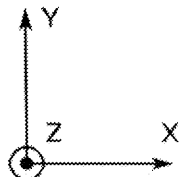
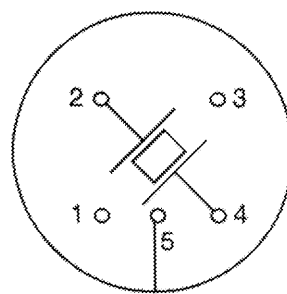



FIGURE 3 - FUNCTIONAL DIAGRAM



(BOTTOM VIEW)

	<p style="text-align: center;">ESCC Detail Specification No. 3501/019</p>	<p style="text-align: right;">PAGE 11 ISSUE 4</p>
---	---	---

4. **REQUIREMENTS**

4.1 **GENERAL**

The complete requirements for procurement of the crystal units specified herein shall be as stated in this specification and ESCC Generic Specification No. 3501 for Quartz Crystal Units. Deviations from the Generic Specification applicable to this specification only, are detailed in Para. 4.2.

Deviations from the applicable Generic Specification and this Detail Specification, formally agreed with specific Manufacturers on the basis that the alternative requirements are equivalent to the ESCC requirements and do not affect the components' reliability, are listed in the appendices attached to this specification.

4.2 **DEVIATIONS FROM GENERIC SPECIFICATION**

4.2.1 **Deviations from Special In-process Controls**

None.

4.2.2 **Deviations from Final Production Tests (Chart II)**

None.

4.2.3 **Deviations from Burn-in Tests (Chart III)**

None.

4.2.4 **Deviations from Qualification Tests (Chart IV)**

None.

4.2.5 **Deviations from Lot Acceptance Tests (Chart V)**

None.

4.3 **MECHANICAL REQUIREMENTS**

4.3.1 **Dimension Check**

The dimensions of the crystal units specified herein shall be checked. They shall conform to those shown in Figure 2.

4.3.2 **Weight**

The maximum weight of the crystal units specified herein shall be 3.0 grammes.

4.3.3 **Robustness of Terminations**

The requirements for robustness of termination testing are specified in Section 9 of ESCC Generic Specification No. 3501.

4.4 **MATERIALS AND FINISHES**

The materials and finishes shall be as specified herein. Where a definite material is not specified, a material which will enable the crystal units specified herein to meet the performance requirements of this specification shall be used. Acceptance or approval of any constituent material does not guarantee acceptance of the finished product.

	<p style="text-align: center;">ESCC Detail Specification No. 3501/019</p>		<p>PAGE 12 ISSUE 4</p>
---	---	--	----------------------------

4.4.1 Case

4.4.1.1 Cap

Copper, nickel plated or nickel and gold plated.

4.4.1.2 Base

Kovar, nickel plated or nickel and gold plated.

4.4.2 Lead Material and Finish

The lead material shall be Type 'D' with either Type '2' (Variant 01) or Type '3 or 4' (Variant 02) finish in accordance with the requirements of ESCC Basic Specification No. 23500. (See Tables 1(a) for Type Variants).

4.5 MARKING

4.5.1 General

The marking of all components delivered to this specification shall be in accordance with the requirements of ESCC Basic Specification No. 21700 and the following paragraphs. When the component is too small to accommodate all of the marking specified, as much as space permits shall be marked and the marking information, in full, shall accompany the component in its primary package.

The information to be marked and the order of precedence, shall be as follows:-

- (a) Characteristics.
- (b) Traceability Information.
- (c) The ESCC Component Number.

4.5.2 Characteristics

The characteristics to be marked are the frequency and the specific crystal identification number.

4.5.2.1 Frequency

The resonance frequency of the crystal units shall be clearly specified in MHz. Where necessary, it shall be specified to 6 decimal places.

4.5.2.2 Specific Crystal Identification Number

This identification shall be allocated by the Manufacturer (see Para. 1.2) and shall consist of the following:

- Letter : First letter of the crystal manufacturer's name.
- 4 digit number : Sequentially allocated by each Manufacturer.

4.5.3 Traceability Information

Each component shall be marked in respect of traceability information in accordance with the requirements of ESCC Basic Specification No. 21700.

4.5.4 The ESCC Component Number

Each component shall bear the ESCC Component Number, which shall be constituted and marked as follows:-

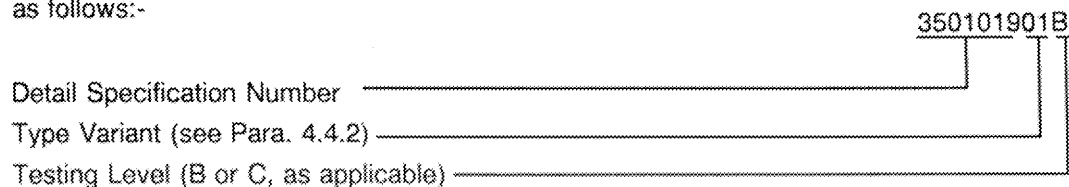

	<p style="text-align: center;">ESCC Detail Specification No. 3501/019</p>	<p style="text-align: right;">PAGE 13 ISSUE 4</p>
---	---	---

4.5.5 Manufacturer's Name, Symbol or Code

The Manufacturer's marking shall be in accordance with the requirements of ESCC Basic Specification No. 21700.

4.6 ELECTRICAL MEASUREMENTS

4.6.1 Electrical Measurements at Reference Temperature

The parameters to be measured in respect of electrical characteristics are scheduled in Table 2.

The measurements shall be performed at the temperatures specified in the individual Tables 1(a), Item 2.

Measurements at reference temperature for OCXO crystals shall be performed at $T_{TP} \pm 1^{\circ}\text{C}$.

4.6.2 Electrical Measurements at High and Low Temperatures

The parameters to be measured at high and low temperatures are scheduled in Table 3. These measurements shall only be performed if values are specified in Tables 1(a) Items 9 and/or 10.

4.6.3 Circuits for Electrical Measurements (Figure 4)

Not applicable.

4.7 BURN-IN TESTS

4.7.1 Parameter Drift Values

The parameter drift values applicable to burn-in are specified in Table 4 of this specification. Unless otherwise stated, measurements shall be performed at $T_{amb} = T_0 \pm 2^{\circ}\text{C}$. The parameter drift values (Delta) applicable to the scheduled parameters shall not be exceeded. In addition to these drift value requirements for a given parameter, the appropriate limit value specified in Table 2 shall not be exceeded.

4.7.2 Conditions for Burn-in

The requirements for burn-in are specified in Section 7 of ESCC Generic Specification No. 3501.

The test shall be performed as a high temperature storage test and the temperature to be applied shall be as specified in Table 5 of this specification.

For a crystal unit functioning in a temperature controlled environment (OCXO), the test should preferably be performed as an operating life test in an oscillator, at the Turning Point Temperature, with a daily measurement of the resonance frequency of the oscillator.

4.7.3 Electrical Circuits for Burn-in (Figure 5)

Not applicable.

TABLE 2 - ELECTRICAL MEASUREMENTS AT REFERENCE TEMPERATURE

No.	Characteristics	Symbol	ESCC 3501 Test Method	Limits	Unit
1	Resonance frequency at reference temperature and rated drive level - with C _O - with C _L	$f_r (T_o, P_o)$ $f_L (T_o, P_o)$	Para. 9.2.1.1	Table 1(a), Item 1 ± Item 7	MHz
2	Resonance resistance at reference temperature and rated drive level - with C _O - with C _L	$R_r (T_o, P_o)$ $R_L (T_o, P_o)$	Para. 9.2.1.1	Table 1(a), Item 8	Ω
3	Frequency variation with Drive Level	$\frac{\Delta f}{f} (T_o, \Delta P)$	Para. 9.2.1.1	Table 1(a), Item 12	10 ⁻⁶
4	Resistance variation with Drive Level	$\frac{\Delta R}{R} (T_o, \Delta P)$	Para. 9.2.1.1	Table 1(a), Item 13	%
5	Motional Inductance	L ₁	Para. 9.2.1.3	Table 1(a), Item 14	mH
6	Static Capacitance	C _o	Para. 9.2.1.4	Table 1(a), Item 16	pF
7	Unwanted response	R_p/R or $ Z_{pl}/R$	Para. 9.2.1.5	Table 1(a), Item 18	-
8	Insulation Resistance	R _i	Para. 9.2.1.6	500 Min.	MΩ

TABLE 3 - ELECTRICAL MEASUREMENTS AT HIGH AND LOW TEMPERATURES

No.	Characteristics	Symbol	ESCC 3501 Test Method	Limits	Unit
9	Frequency variation with Temperature over T _{op}	$\frac{\Delta f}{f} (\Delta T, P_o)$	Para. 9.2.1.2	Table 1(a) Item 9	10 ⁻⁶
10	Resistance variation with Temperature over T _{op}	$\frac{\Delta R}{R} (\Delta T, P_o)$	Para. 9.2.1.2	Table 1(a) Item 10	%

FIGURE 4 - CIRCUITS FOR ELECTRICAL MEASUREMENTS

Not applicable.

TABLE 4 - PARAMETER DRIFT VALUES

No.	Characteristics	Symbol	Spec. and/or Test Method	Test Conditions	Change Limits (Δ)	Unit
1	Resonance frequency drift	$\frac{\Delta f}{f}$	As per Table 2	As per Table 2	± 2.0	10^{-6}
2	Resonance resistance drift	$\frac{\Delta R}{R}$	As per Table 2	As per Table 2	± 10 or (1) ± 1.0	% Ω

NOTES

1. Whichever is the highest value.

TABLE 5 - CONDITIONS FOR BURN-IN AND LAT LIFE TESTS

No.	Characteristics	Symbol	Condition (Note 1)	Unit
1	Ambient Temperature	T_{amb}	+105 (+0-5)	$^{\circ}\text{C}$

NOTES

1. See Para. 4.7.2

FIGURE 5 - ELECTRICAL CIRCUIT FOR BURN-IN AND LIFE TEST

Not applicable.

4.8 ENVIRONMENTAL AND ENDURANCE TESTS (CHARTS IV AND V OF ESCC GENERIC SPECIFICATION NO. 3501)

4.8.1 Measurements and Inspections on Completion of Environmental Tests

The parameters to be measured and inspections to be performed on completion of environmental tests are scheduled in Table 6. Unless otherwise stated, the measurements shall be performed at $T_{amb} = T_o \pm 2^{\circ}\text{C}$.

4.8.2 Measurements and Inspections at Intermediate Points and on Completion of Endurance Tests

The parameters to be measured and inspections to be performed at intermediate points and on completion of endurance tests are scheduled in Table 6. Unless otherwise stated, the measurements shall be performed at $T_{amb} = T_o \pm 2^{\circ}\text{C}$.

4.8.3 Conditions for Operating Life Test (Part of Endurance Testing)

The requirements for the operating life test are specified in Section 9 of ESCC Generic Specification No. 3501. The test shall be performed as a high temperature storage test and the test temperatures are specified in ESCC Generic Specification No. 3501 for Qualification Testing and in Table 5 of this specification for LAT Testing.

For a crystal unit functioning in a temperature controlled environment (OCXO), the test should preferably be performed as an operating life test in an oscillator, at the Turning Point Temperature, with a daily measurement of the resonance frequency of the oscillator.



TABLE 6 - MEASUREMENTS AND INSPECTIONS ON COMPLETION OF ENVIRONMENTAL TESTS AND AT INTERMEDIATE POINTS AND ON COMPLETION OF ENDURANCE TESTING

NO.	ESCC GENERIC SPEC. NO. 3501		MEASUREMENTS AND INSPECTIONS		SYMBOL	LIMITS		UNIT
	ENVIRONMENTAL AND ENDURANCE TESTS (1)	TEST METHOD AND CONDITIONS	IDENTIFICATION	CONDITIONS		Min.	Max.	
01	Electrical Measurements at Reference Temperature	Para. 9.2.4	Electrical Measurements	Table 2		Table 1(a)		
02	Shock	Para. 9.3	Initial Measurements Resonance Frequency Resonance Resistance Final Measurements Resonance Frequency Drift Resonance Resistance Drift	Table 2 Item 1 Table 2 Item 2 Table 2 Item 1 Table 2 Item 2	f R $\frac{\Delta f}{f}$ $\frac{\Delta R}{R}$ ΔR	Table 2 Item 1 Table 2 Item 2 -1.0 -10 -1.0	+1.0 +1.0 +1.0 +1.0	 10 ⁻⁶ % Ω
03	Vibration	Para. 9.4	Initial Measurements Resonance Frequency Resonance Resistance Final Measurements Resonance Frequency Drift Resonance Resistance Drift	Table 2 Item 1 Table 2 Item 2 Table 2 Item 1 Table 2 Item 2	f R $\frac{\Delta f}{f}$ $\frac{\Delta R}{R}$ ΔR	Table 2 Item 1 Table 2 Item 2 -1.0 -10 -1.0	+1.0 +1.0 +1.0 +1.0	 10 ⁻⁶ % Ω
04	Seal Test	Para. 9.5	Fine Leak Gross Leak	Para. 9.5.1 Para. 9.5.2		Para. 9.5.1 Para. 9.5.2		
05	Permanence of Marking	Para. 9.8	Final Measurements Visual Examination	No corrosion or obliteration of marking	-	-	-	-
06	External Visual Inspection	Para. 9.9	Final Measurements Visual Inspection	ESCC No. 20500	-	-	-	-
07	Solderability	Para. 9.13	-	-	-	-	-	-

NOTES

1. The tests in this table refer to either Chart IV or V, and shall be used as applicable.
2. Whichever is the highest value.

TABLE 6 - MEASUREMENTS AND INSPECTIONS ON COMPLETION OF ENVIRONMENTAL TESTS AND AT INTERMEDIATE POINTS AND ON COMPLETION OF ENDURANCE TESTING (Cont.)

NO.	ESCC GENERIC SPEC. NO. 3501		MEASUREMENTS AND INSPECTIONS		SYMBOL	LIMITS		UNIT
	ENVIRONMENTAL AND ENDURANCE TESTS (1)	TEST METHOD AND CONDITIONS	IDENTIFICATION	CONDITIONS		Min.	Max.	
08	Climatic Sequence Dry Heat	Para. 9.14 Para. 9.14.1	Initial Measurements					
			Resonance Frequency	Table 2 Item 1	f	Table 2 Item 1		
			Resonance Resistance	Table 2 Item 2	R	Table 2 Item 2		
			Final Measurements					
09	Cold	Para. 9.14.3	Resonance Frequency	Table 2 Item 1	$\frac{\Delta f}{f}$	-2.0	+2.0	10 ⁻⁶
			Drift		f			
			Resonance Resistance	Table 2 Item 2	$\frac{\Delta R}{R}$	-10	+10	%
			Drift		R	or (2)		
10	Damp Heat (Accelerated) Remaining Cycles	Para. 9.14.4	Resonance Resistance	Table 2 Item 2	$\frac{\Delta R}{R}$	-1.0	+1.0	Ω
			Drift		ΔR			
			Initial Measurements					
			Resonance Frequency	Table 2 Item 1	f	Para. 9.14.1.3		
11	Rapid Change of Temperature	Para. 9.15	Resonance Resistance	Table 2 Item 2	R	Final Measurements		
			Final Measurements					
			Resonance Frequency	Table 2 Item 1	$\frac{\Delta f}{f}$	-2.0	+2.0	10 ⁻⁶
			Drift		f			
12	Robustness of Terminations	Para. 9.16	Resonance Resistance	Table 2 Item 2	$\frac{\Delta R}{R}$	-10	+10	%
			Drift		R	or (2)		
			Insulation Resistance	Table 2 Item 8	R _i	-1.0	+1.0	Ω
						500	-	MΩ

NOTES

1. The tests in this table refer to either Chart IV or V, and shall be used as applicable.
2. Whichever is the highest value.

TABLE 6 - MEASUREMENTS AND INSPECTIONS ON COMPLETION OF ENVIRONMENTAL TESTS AND AT INTERMEDIATE POINTS AND ON COMPLETION OF ENDURANCE TESTING (Cont.)

NO.	ESCC GENERIC SPEC. NO. 3501		MEASUREMENTS AND INSPECTIONS		SYMBOL	LIMITS		UNIT
	ENVIRONMENTAL AND ENDURANCE TESTS (1)	TEST METHOD AND CONDITIONS	IDENTIFICATION	CONDITIONS		Min.	Max.	
13	Life Test	Para. 9.17	Initial Measurements					
			Resonance Frequency	Table 2 Item 1	f			
			Resonance Resistance	Table 2 Item 2	R			
			Intermediate Measurements	At 500 hours				
			Resonance Frequency	Table 2 Item 1	$\frac{\Delta f}{f}$	-2.0	+2.0	10^{-6}
			Drift		f			
			Resonance Resistance	Table 2 Item 2	$\frac{\Delta R}{R}$	-10	+10	%
			Drift		R	or (2)		
					ΔR	-1.0	+1.0	Ω
			Intermediate Measurements (Chart IV) and Final Measurements (Chart V)	At 1000 hours				
			Resonance Frequency	Table 2 Item 1	$\frac{\Delta f}{f}$	-2.5	+2.5	10^{-6}
			Drift		f			
			Resonance Resistance	Table 2 Item 2	$\frac{\Delta R}{R}$	-10	+10	%
			Drift		R	or (2)		
		ΔR	-1.0	+1.0	Ω			
Final Measurements (Chart IV)	At 2000 hours							
Resonance Frequency	Table 2 Item 1	$\frac{\Delta f}{f}$	-3.0	+3.0	10^{-6}			
Drift		f						
Resonance Resistance	Table 2 Item 2	$\frac{\Delta R}{R}$	-10	+10	%			
Drift		R	or (2)					
		ΔR	-1.0	+1.0	Ω			

NOTES

1. The tests in this table refer to either Chart IV or V, and shall be used as applicable.
2. Whichever is the highest value.

	<p>ESCC Detail Specification No. 3501/019</p>		<p>PAGE 19 ISSUE 4</p>
---	---	--	----------------------------

APPENDIX 'A'

Page 1 of 1

AGREED DEVIATIONS FOR RAKON (F)

ITEMS AFFECTED	DESCRIPTION OF DEVIATION
Para. 4.2.2	Para. 9.3, Shock: Shall not be performed.
Para. 4.2.3	Para. 9.11, Radiographic Inspection: Shall not be performed.

	<p>ESCC Detail Specification No. 3501/019</p>		<p>PAGE 20 ISSUE 4</p>
---	---	--	----------------------------

APPENDIX 'B'

Page 1 of 1

AGREED DEVIATIONS FOR KVG Quartz Crystal Technology GmbH (D)

ITEMS AFFECTED	DESCRIPTION OF DEVIATION
Para. 4.2.2 Para. 4.2.3 Para. 4.2.4 Para. 4.2.5	Para. 9.5.1, Seal Test Fine Leak: The crystal units shall be subjected to MIL-STD-202, Method 112, Procedure IIIa.