



Page i

**R.F. COILS, FIXED**


**ESCC Generic Specification No. 3201**

**ISSUE 1**

**October 2002**



Document Custodian: European Space Agency - see <https://escies.org>

	ESCC Generic Specification		PAGE ii ISSUE 1
---	----------------------------	--	--------------------

### **LEGAL DISCLAIMER AND COPYRIGHT**

European Space Agency, Copyright © 2002. All rights reserved.

The European Space Agency disclaims any liability or responsibility, to any person or entity, with respect to any loss or damage caused, or alleged to be caused, directly or indirectly by the use and application of this ESCC publication.

This publication, without the prior permission of the European Space Agency and provided that it is not used for a commercial purpose, may be:

- copied in whole in any medium without alteration or modification.
- copied in part, in any medium, provided that the ESCC document identification, comprising the ESCC symbol, document number and document issue, is removed.



europaean space agency  
agence spatiale européenne

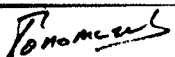
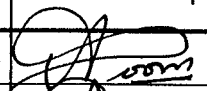
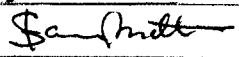

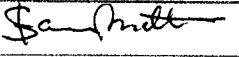

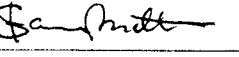
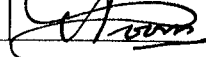
Pages 1 to 47

**R.F. COILS, FIXED**

**ESA/SCC Generic Specification No. 3201**



**space components  
coordination group**

Issue/Rev.	Date	Approved by	
		SCCG Chairman	ESA Director General or his Deputy
Issue 3	June 1995		
Revision 'A'	August 1997		
Revision 'B'	March 1998		
Revision 'C'	April 1999		



**DOCUMENTATION CHANGE NOTICE**

Rev. Letter	Rev. Date	Reference	CHANGE Item	Approved DCR No.
			This Issue supersedes Issue 2 and incorporates all modifications defined in Revisions 'A' and 'B' to Issue 2 and the following DCR's:- Cover Page DCN	None None
		Para. 2.1	: No. 21500 deleted in toto : No. 24600 added : No. 24800 added : First sentence amended	21078 21078 23575 23575/ 21078
		Para. 2.2	: ESA PSS-01-702 added	221007
		Para. 4.5	: New paragraph added	221007/ 23605
		Para. 7.1	: Last sentence amended	221213
		Para. 8.2.4	: (a) amended	221213
		Para. 8.2.5	: (a) amended	221213
		Chart III	: New box added	221213
		Chart V	: Permanence of Marking moved from Level 1 to Level 3	21054
		Para. 9.3.1.1	: First sentence amended : (c) added	221213 221213
		Para. 9.3.1.1.5	: New paragraph added	221213
		Para. 9.3.1.2	: Title added to existing text	221213
		Para. 9.3.1.2.2	: New paragraph added	221213
		Para. 9.3.1.3	: Title added to existing text	221213
		Para. 9.3.1.3.1	: Renumbered as "9.3.1.3.2"	221213
		Para. 9.3.1.3.3	: New paragraph added	221213
		Para. 9.3.1.5	: (a) Title added to existing text : (a) 2 text added : (f) Title added to existing text : (f) 2 text added	221213 221213 221213 221213
		Para. 9.3.1.6	: (b) New alinea added	221213
		Para. 9.3.2	: Last sentence amended	221213
		Para. 9.3.3	: Last sentence amended	221213
		Para. 9.3.4	: Last sentence amended	221213
		Para. 9.3.5	: Last sentence amended	221213
		Para. 9.7	: New Title added to existing text	221213
		Para. 9.7.2	: New paragraph added	221213
		Para. 9.8	: (a) Title added to existing text : (a) 2 text added	221213 221213
		Para. 9.9	: "cylindrical" deleted from the first sentence	221213
		Para. 9.9.1	: Title deleted in toto	221213
		Para. 9.11	: (b) New sentence added : (c) SMD test conditions added	221213 221213
		Para. 9.12	: New Title added to existing text	221213
		Para. 9.12.2	: New paragraph added	221213
		Para. 9.13	: No. 21700 changed to "24800"	23575
		Para. 9.14	: (a) New sentence added : (b) Title added to existing text of 2nd alinea : (b) 2 text added	221213 221213 221213
		Para. 9.18	: (a) New title added to existing text : (a) 2 text added	221213 221213



**DOCUMENTATION CHANGE NOTICE**

Rev. Letter	Rev. Date	Reference	CHANGE Item	Approved DCR No.
		Para. 9.19.1	: (b) 3 text added	221213
			: (c) text deleted and new text added	221213
		Para. 9.12.2	: (b) 3 text added	221213
			: (c) text deleted and new text added	221213
		Para. 10.2	: (e) "or jig positions" added	221213
		Para. 10.7.1	: "or jig positions" added to first two sentences	221213
		Para. 10.10	: (b) "or jig positions" added	221213
'A'	Aug. '97	Implementation of Policy DCR 21107 is completed by the changes introduced by the following DCR:-		
		P1.	Cover page	None
		P2A.	DCN	None
		P5.	T of C	None
			: Para. 10.1.3 entry renumbered to "41A"	23872
			: Para. 10.1.4 entry added	23872
		P7.	Para. 4.1	23872
			: Second paragraph amended	23872
			: New paragraph added	23872
			Para. 4.1.3	23872
			: Second sentence amended	23872
		P8.	Para. 4.1.4	23872
			: Text amended	23872
		P10.	Chart I	23872
			: "(1)" added to Lot Acceptance Boxes and Note added	23872
		P13.	Para. 8.2.1	23872
			: In the last paragraph, both sentences amended	23872
		P14.	Para. 8.2.3	23872
			: Text added to the beginning of (e)	23872
		P15.	Para. 8.4	23872
			: In the last paragraph, "either" and all after "months" deleted	23872
		P20.	Para. 9	23872
			: Text added	23872
			Para. 9.3.1.1	None
			: (b) (i), First paragraph moved to Page 21	None
		P21.	Para. 9.3.1.1	None
			: (b) (i), First paragraph added from Page 20	23872
		P41.	Para. 10.1	23872
			: "(when applicable)" added to (h)	23872
			Para. 10.1.2	23872
			: Existing text deleted and new text added	23872
			Para. 10.1.3	None
			: Moved to Page 41A	None
		P41A.		None
			: Page added	None
			Para. 10.1.3	23872
			: Heading added from Page 40	23872
			: Existing text deleted and new text added	23872
			Para. 10.1.4	23872
			: New paragraph added	23872
		P42.	Para. 10.2	23872
			: (e) amended	23872
			Para. 10.3	23872
			: First sentence amended	23872
			Para. 10.6	23872
			: In the second paragraph, second sentence amended	23872
			: Last paragraph deleted	23872
		P43.	Para. 10.7.1	23872
			: In the second sentence, "provided" replaced by "recorded"	23872
			Para. 10.7.2	23872
			: In the text, "provided" replaced by "prepared"	23872
		P44.	Para. 11	23872
			: In (b), "(when applicable)," added after "testing"	23872
			: In the last sentence, ", when requested," added after "copied"	23872
'B'	Mar. '98	P1.	Cover page	None
		P2A.	DCN	None
		P2B.	DCN	None
			: Page added	221365
		P6.	Para. 2.1	221366
			: ESA/SCC No. 20400 added	221366
		P13.	Para. 8.1.2	221366
			: New penultimate sentence added	221366
		P20.	Para. 9.2	221366
			: For Chart II, Test Conditions amended and text added	221366
			: For Charts IV and IV, Test Conditions amended	221366
			Para. 9.3.1.1	None
			: Moved to Page 20A	None



**DOCUMENTATION CHANGE NOTICE**

Rev. Letter	Rev. Date	Reference	CHANGE Item	Approved DCR No.
		P20A.	: Page added	None
		Para. 9.3.1.1	: Added from Page 20	None
			: (a) "f <sub>o</sub> " amended to "f <sub>r</sub> "	221365
		P29. Para. 9.3.1.4	: Second sentence added	221365
		Para. 9.3.1.5	: (b) First sentence amended	221365
		P30. Para. 9.3.1.6	: (a) "then" corrected to "than"	221365
		P32. Para. 9.8	: (c) Text deleted and new text added	221366
		P33. Para. 9.9	: Paragraph completely rewritten	221365
		P35. Para. 9.10	: Last sentence deleted and new sentence added	221365
'C'	Apr. '99	P1. Cover page		None
		P2B. DCN		None
		P13. Para. 8.2.1	: New second sentence added to last paragraph	21111
		P41. Para. 10.1.2.1	: Item (b), "PDA figure and" deleted from text	21119
			: Item (c) rewritten	21119
		P41A. Para. 10.1.3.1	: Item (a), "(including PDA figure)" deleted	21119




**TABLE OF CONTENTS**

	<u>Page</u>
<b>1. <u>INTRODUCTION</u></b>	<b>6</b>
1.1 Scope	6
1.2 Applicability	6
<b>2. <u>APPLICABLE DOCUMENTS</u></b>	<b>6</b>
2.1 ESA/SCC Specifications	6
2.2 Other (Reference) Documents	7
2.3 Order of Precedence	7
<b>3. <u>TERMS, DEFINITIONS, ABBREVIATIONS, SYMBOLS AND UNITS</u></b>	<b>7</b>
<b>4. <u>REQUIREMENTS</u></b>	<b>7</b>
4.1 General	7
4.1.1 Specifications	7
4.1.2 Conditions and Methods of Test	7
4.1.3 Manufacturer's Responsibility for Performance of Tests and Inspections	7
4.1.4 Inspection Rights	8
4.1.5 Pre-encapsulation Inspection	8
4.2 Qualification Approval Requirements on a Manufacturer	8
4.3 Deliverable Components	8
4.3.1 Lot Failure	8
4.3.2 Testing and Lot Acceptance Levels	9
4.4 Marking	9
4.5 Materials and Finishes	9
<b>5. <u>PRODUCTION CONTROL</u></b>	<b>9</b>
5.1 General	9
5.2 Special In-process Controls	9
<b>6. <u>FINAL PRODUCTION TESTS</u></b>	<b>11</b>
6.1 General	11
6.2 Test Methods and Conditions	11
6.3 Documentation	11
<b>7. <u>BURN-IN AND ELECTRICAL MEASUREMENTS</u></b>	<b>11</b>
7.1 General	11
7.1.1 Conditions of Test	11
7.1.2 Data Points	11
7.2 Failure Criteria	12
7.2.1 Parameter Drift Failure	12
7.2.2 Parameter Limit Failure	12
7.2.3 Other Failures	12
7.3 Failed Components	12
7.4 Lot Failure	12
7.4.1 Lot Failure during 100% Testing	12
7.4.2 Lot Failure during Sample Testing	12
7.5 Documentation	13




	<u>Page</u>
<b>8. <u>QUALIFICATION APPROVAL AND LOT ACCEPTANCE TESTS</u></b>	<b>13</b>
8.1 Qualification Testing	13
8.1.1 General	13
8.1.2 Distribution within the Qualification Test Lot	13
8.2 Lot Acceptance Testing	13
8.2.1 General	13
8.2.2 Distribution within the Sample for Lot Acceptance Testing	13
8.2.3 Lot Acceptance Level 3 Testing	14
8.2.4 Lot Acceptance Level 2 Testing	14
8.2.5 Lot Acceptance Level 1 Testing	14
8.3 Failure Criteria	14
8.3.1 Environmental and Mechanical Test Failures	15
8.3.2 Electrical Failures	15
8.3.3 Other Failures	15
8.4 Failed Components	15
8.5 Lot Failure	15
8.6 Documentation	15
<b>9. <u>TEST METHODS AND PROCEDURES</u></b>	<b>20</b>
9.1 Internal Visual Inspection	20
9.2 Thermal Shock	20
9.3 Electrical Measurements	20
9.3.1 General	20
9.3.2 Parameter Drift Value Measurements	31
9.3.3 Electrical Measurements at High and Low Temperatures	31
9.3.4 Electrical Measurements at Room Temperature	31
9.3.5 Electrical Measurements during Endurance Testing	31
9.4 Radiographic Inspection	31
9.5 External Visual Inspection	31
9.6 Dimension Check	31
9.7 Solderability	31
9.7.1 For Cylindrical Coils	31
9.7.2 For SMD Coils	32
9.8 Barometric Pressure	32
9.9 Temperature Rise	33
9.10 Overload	35
9.11 Resistance to Soldering Heat	35
9.12 Terminal Strength	35
9.12.1 For Cylindrical Coils	35
9.12.2 For SMD Coils	36
9.13 Permanence of Marking	36
9.14 Low Temperature Storage	36
9.15 Vibration	37
9.16 Shock	37
9.17 Immersion	37
9.18 Moisture Resistance	38
9.19 Operating Life	39
9.19.1 Operating Life during Qualification Testing	39
9.19.2 Operating Life during Acceptance Testing	39
9.20 Final Assembly	40



 <b>ESCC</b>	ESA/SCC Generic Specification No. 3201	- Rev. 'A'	PAGE 5 ISSUE 3
--	---	---------------	-------------------

	<u>Page</u>
<b>10. DATA DOCUMENTATION</b>	<b>41</b>
10.1 General	41
10.1.1 Qualification Approval	41
10.1.2 Testing Level 'B'	41
10.1.3 Testing Level 'C'	41A
10.1.4 Data Retention/Data Access	41A
10.2 Cover Sheet(s)	42
10.3 List of Equipment Used	42
10.4 List of Test References	42
10.5 Special In-process Control Data	42
10.6 Final Production Test Data	42
10.7 Burn-in and Electrical Measurement Data	43
10.7.1 Testing Level 'B'	43
10.7.2 Testing Level 'C'	43
10.8 Qualification Test Data	43
10.9 Lot Acceptance Test Data	43
10.9.1 Testing Level 'B'	43
10.9.2 Testing Level 'C'	43
10.10 Failed Component List and Failure Analysis Report	44
10.11 Certificate of Conformity	44
<b>11. DELIVERY</b>	<b>44</b>
<b>12. PACKAGING AND DESPATCH</b>	<b>44</b>
<b><u>CHARTS</u></b>	
I TESTING LEVELS	10
II FINAL PRODUCTION TESTS	16
III BURN-IN AND ELECTRICAL MEASUREMENTS	17
IV QUALIFICATION TESTS	18
V LOT ACCEPTANCE TESTS	19
<b><u>FIGURES</u></b>	
I TEST FIXTURES TF-A (FOR AXIAL LEADS)	24
II SHORTING BAR FOR TEST FIXTURE TF-A (FOR AXIAL LEADS)	24
III TEST FIXTURE TF-B (FOR AXIAL LEADS)	25
IV SHORTING BAR FOR TEST FIXTURE TF-B (FOR AXIAL LEADS)	25
V TEST FIXTURES TF-C, TF-D AND TF-E (FOR RADIAL LEADS)	26
V-A DETAIL	26
VI TEST FIXTURE FOR SELF-RESONANT FREQUENCY TEST (FOR AXIAL LEADS)	28
VII TEST FIXTURE FOR SELF-RESONANT FREQUENCY TEST (FOR RADIAL LEADS)	29
VIII COIL-CONTACTING ASSEMBLY FOR MOUNTING DURING POLARISATION	30
IX TEST FIXTURE FOR TEMPERATURE RISE TEST ON INSULATED COILS	34
<b><u>ANNEXES</u></b>	
I LTPD SAMPLING PLAN FOR LOT SIZES GREATER THAN 200 DEVICES	45
LTPD SAMPLING PLAN FOR LOT SIZES LESS THAN OR EQUAL TO 200 DEVICES	46

	<p style="text-align: center;">ESA/SCC Generic Specification No. 3201</p>	<p style="text-align: center;">Rev. 'B'</p>	<p style="text-align: right;">PAGE 6 ISSUE 3</p>
--	---	---	--

## 1. INTRODUCTION

### 1.1 SCOPE

This specification defines the general requirements for the qualification approval, procurement, including lot acceptance testing, and delivery of Coils, R.F., Fixed for space applications.

This specification contains the appropriate inspection and test schedules and also specifies the data documentation requirements.

### 1.2 APPLICABILITY

This specification is primarily applicable to the granting of qualification approval to a component in accordance with ESA/SCC Basic Specification No. 20100 and the procurement of such components from qualified Manufacturers.

## 2. APPLICABLE DOCUMENTS

The following documents form part of, and shall be read in conjunction with, this specification. The relevant issues shall be those in effect on the date of placing the purchase order.

### 2.1 ESA/SCC SPECIFICATIONS

No. 20100, Requirements for the Qualification of Standard Electronic Components for Space Application.

No. 20400, Internal Visual Inspection.

No. 20500, External Visual Inspection.

No. 20600, Preservation, Packaging and Despatch of SCC Electronic Components.

No. 20900, Radiographic Inspection.

No. 21300, Terms, Definitions, Abbreviations, Symbols and Units.

No. 21700, General Requirements for the Marking of SCC Components.

No. 22800, ESA/SCC Non-conformance Control System.

No. 23500, Lead Materials and Finishes for Components for Space Application.

No. 24600, Minimum Quality System Requirements.

No. 24800, Resistance to Solvents of Marking, Materials and Finishes.

With the exception of ESA/SCC Basic Specifications Nos. 20100, 21700, 22800 and 24600, where Manufacturers' specifications are equivalent to, or more stringent than, the ESA/SCC Basic Specifications listed above, they may be used in place of the latter, subject to the approval of the appropriate Qualifying Space Agency.

Such replacements shall be clearly identified in the applicable Process Identification Document (P.I.D.) and listed in an appendix to the appropriate Detail Specification.

Unless otherwise stated herein, references within the text of this specification to "the Detail Specification" shall mean the relevant ESA/SCC Detail Specification.



## 2.2 OTHER (REFERENCE) DOCUMENTS

IEC Publication No. 410, Sampling Plans and Procedures for Inspection by Attributes or,  
MIL-STD-105, Sampling Procedures and Tables for Inspection by Attributes.  
MIL-STD-202, Test Methods for Electronic and Electrical Component Parts.  
MIL-STD-414, Sampling Procedures and Tables for Inspection by Variables for Percent Defective.  
ESA PSS-01-702, A Thermal Vacuum Test for the Screening of Space Materials.

## 2.3 ORDER OF PRECEDENCE

For the purpose of interpretation and in case of conflict with regard to documentation, the following order of precedence shall apply:-

- (a) ESA/SCC Detail Specification.
- (b) ESA/SCC Generic Specification.
- (c) ESA/SCC Basic Specification.
- (d) Other documents, if referenced herein.

## 3. TERMS, DEFINITIONS, ABBREVIATIONS, SYMBOLS AND UNITS

The terms, definitions, abbreviations, symbols and units specified in ESA/SCC Basic Specification No. 21300 shall apply.

## 4. REQUIREMENTS

### 4.1 GENERAL

The test requirements for qualification approval of a component shall comprise final production tests (see Chart II), burn-in and electrical measurements to testing level 'B' (see Chart III) and qualification testing (see Chart IV).

The test requirements for procurement of components shall comprise final production tests (Chart II), burn-in and electrical measurements to testing level 'B' or 'C' as required (Chart III) together with, when applicable, a level of lot acceptance testing (see Chart V) to be specified by the Orderer.

If a Manufacturer elects to eliminate a final production test by substituting an in-process control or statistical process control procedure, the Manufacturer is still responsible for delivering components that meet all of the performance, quality and reliability requirements defined in this specification and the Detail Specification.

#### 4.1.1 Specifications



For qualification approval, procurement (including lot acceptance testing) and delivery of components in conformity with this specification, the specifications listed in Section 2 of this document shall apply in total unless otherwise specified herein or in the Detail Specification.

#### 4.1.2 Conditions and Methods of Test

The conditions and methods of test shall be in accordance with this specification, the ESA/SCC Basic Specifications referenced herein and the Detail Specification.

#### 4.1.3 Manufacturer's Responsibility for Performance of Tests and Inspections

The Manufacturer shall be responsible for the performance of tests and inspections required by the applicable specifications. These tests and inspections shall be performed at the plant of the Manufacturer of the components unless it is agreed by the Qualifying Space Agency prior to commencing qualification testing, or procurement, to use an approved external facility.

 	<p style="text-align: center;">ESA/SCC Generic Specification No. 3201</p>	<p style="text-align: center;">- Rev. 'A'</p>	<p>PAGE 8 ISSUE 3</p>
---	---	---	---------------------------

4.1.4 Inspection Rights

The Qualifying Space Agency (for qualification approval or for a procurement) reserves the right to monitor any of the tests and inspections scheduled in the applicable specifications.

4.1.5 Pre-encapsulation Inspection

The manufacturer shall notify the Orderer at least 2 working weeks before the commencement of pre-encapsulation inspection. The Orderer shall indicate immediately whether or not he intends to witness the inspection.

4.2 QUALIFICATION APPROVAL REQUIREMENTS ON A MANUFACTURER

To obtain and maintain the qualification approval of a component, or family of components, a Manufacturer shall satisfy the requirements of ESA/SCC Basic Specification No. 20100.

4.3 DELIVERABLE COMPONENTS

Components delivered to this specification shall be processed and inspected in accordance with the relevant Process Identification Document (P.I.D.). Each delivered component shall be traceable to its production lot. Components delivered to this specification shall have completed satisfactorily all tests to the testing level and lot acceptance level specified in the purchase order (see Para. 4.3.2).

ESA/SCC qualified components delivered to this specification shall be produced from lots that are capable of passing all tests, and sequences of tests, that are defined in Charts IV and V. The Manufacturer shall not knowingly supply components that cannot meet this requirement. In the event that, subsequent to delivery and prior to operational use, a component is found to be in a condition such that it could not have passed these tests at the time of manufacture, this shall be grounds for rejection of the delivered lot.

Components failing inspections and tests of the higher testing level (i.e level 'B') shall not be supplied against any order for components of the lower testing level.

4.3.1 Lot Failure

Lot failure may occur during final production tests (Chart II), burn-in and electrical measurements (Chart III), qualification testing (Chart IV) or lot acceptance testing (Chart V).

Should such failure occur, the non-conformance procedure shall be initiated in accordance with ESA/SCC Basic Specification No. 22800.

Should such failure occur during procurement, the Manufacturer shall notify the Orderer by telex within 2 working days, giving details of the number and mode of failure and the suspected cause.

In the case where qualification approval has been granted to the component, he shall, at the same time by the same means, inform the Qualifying Space Agency in order that the latter may consider its implications.

No further testing shall be performed on the failed components except on instruction from the Orderer. The Orderer shall inform the Manufacturer and the Qualifying Space Agency within 2 working days of receipt of the telex, by the same means, what action shall be taken.

In the case when lot failure occurs during qualification testing, the Manufacturer shall immediately notify the appropriate Qualifying Space Agency who will define a course of action to be followed. No further testing shall be performed on the failed components.

**SCC**ESA/SCC Generic Specification  
No. 3201

PAGE 9

ISSUE 3

#### 4.3.2 Testing and Lot Acceptance Levels

This specification defines 2 levels of testing severity which are designated by the letters 'B' and 'C' (see Chart I) and 3 levels of lot acceptance testing (see Chart V).

The lot acceptance levels are designated 1, 2 and 3 and are comprised of tests as follows:-

Level 3 (LA3) - Electrical Subgroup.

Level 2 (LA2) - Endurance Subgroup,  
plus Electrical Subgroup.

Level 1 (LA1) - Environmental and Mechanical Subgroup,  
plus Endurance Subgroup,  
plus Electrical Subgroup.

The required testing level and lot acceptance level shall both be specified in a purchase order.

#### 4.4 MARKING

All components procured and delivered to this specification from a source qualified according to ESA/SCC Basic Specification No. 20100 shall be marked in accordance with ESA/SCC Basic Specification No. 21700. Thus, they shall bear the ESA symbol to signify their conformance to the ESA/SCC qualification approval requirements and full compliance with the requirements of this specification and the Detail Specification.

Components procured from sources which are not ESA/SCC qualified, provided that they fully comply with the procurement requirements of this specification and the Detail Specification, may bear the SCC marking **with the exception of the ESA symbol.**

#### 4.5 MATERIALS AND FINISHES

All non-metallic materials and finishes that are not within a hermetically sealed enclosure, of the components specified herein shall meet the outgassing requirements as outlined in ESA PSS-01-702.

Specific requirements for materials and finishes are specified in the Detail Specification.

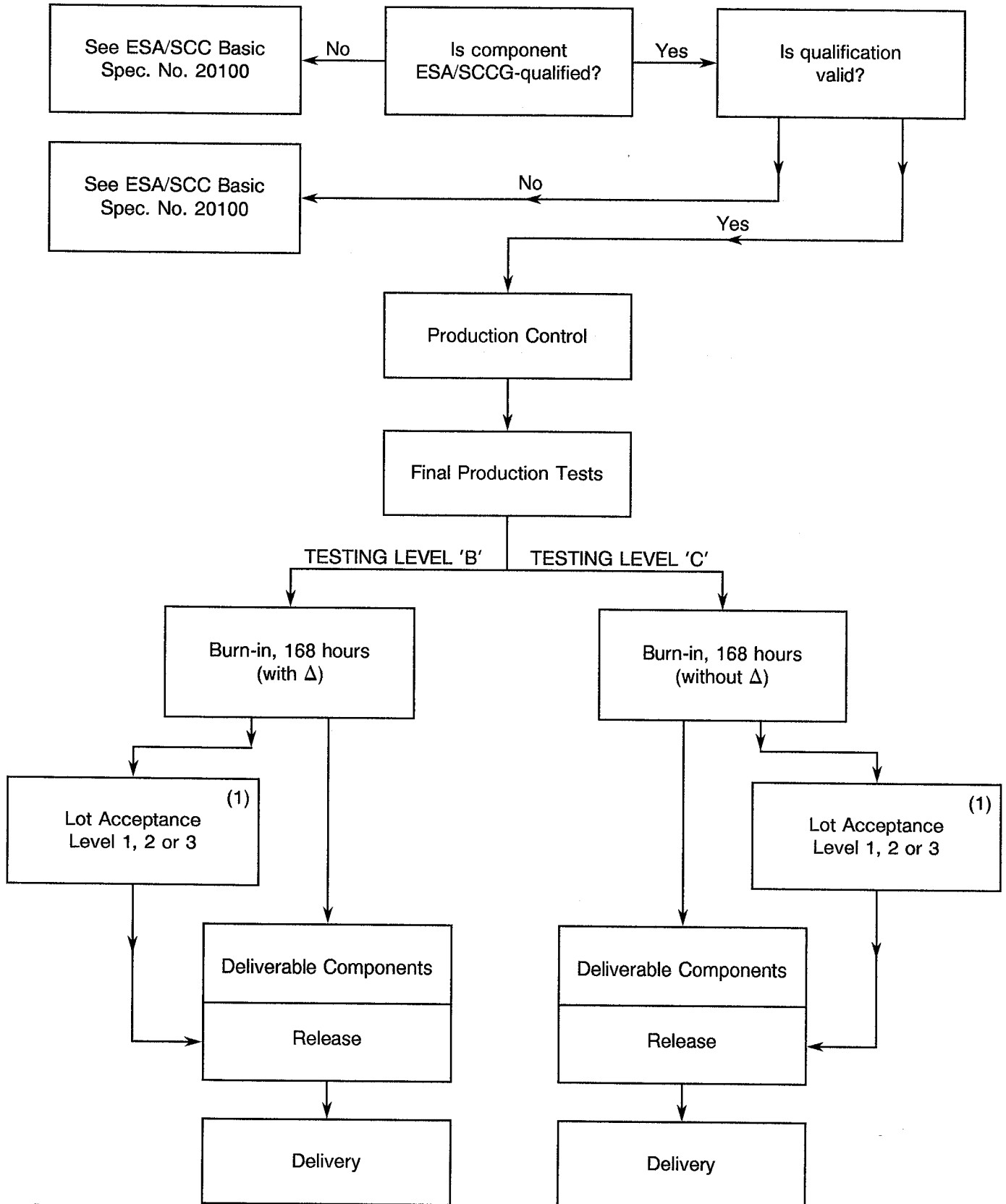
### 5. PRODUCTION CONTROL

#### 5.1 GENERAL

The minimum requirements for production control, which are equally applicable to procurement, are defined in ESA/SCC Basic Specification No. 20100, Para's 5.1 and 5.2.

#### 5.2 SPECIAL IN-PROCESS CONTROLS

Where applicable, special in-process controls shall apply as specified in the Detail Specification.

**CHART I - TESTING LEVELS**

**NOTES**

1. When applicable.

**6. FINAL PRODUCTION TESTS****6.1 GENERAL**

Unless otherwise specified in the Detail Specification, all components used for qualification testing and all components for delivery, including those submitted to lot acceptance tests, shall be subjected to tests and inspections in accordance with Chart II.

Unless otherwise specified in the Detail Specification, the tests shall be performed in the order shown.

Any components that do not meet these requirements shall be removed from the lot and at no future time be re-submitted to the requirements of this specification.

**6.2 TEST METHODS AND CONDITIONS**

The applicable test methods and conditions are specified in the paragraphs referenced in Chart II of this specification.

**6.3 DOCUMENTATION**

Documentation of final production test data shall be in accordance with the requirements of Para. 10.6 of this specification.

**7. BURN-IN AND ELECTRICAL MEASUREMENTS****7.1 GENERAL**

Unless otherwise specified in the Detail Specification, all components used for qualification testing and all components for delivery, including those submitted to lot acceptance tests, shall be subjected to tests and inspections in accordance with Chart III.

Unless otherwise specified in the Detail Specification, the tests shall be performed in the order shown.

The applicable test methods and conditions are specified in the paragraphs referenced in Chart III.

Components of testing level 'B' shall be serialised or defined by jig position prior to the tests and inspections.

**7.1.1 Conditions of Test**

The conditions for burn-in shall be as shown in Table 5 of the Detail Specification.

Unless otherwise specified in the Detail Specification, components of both Levels 'B' and 'C' shall be subjected to a total burn-in period of 168 hours.

**7.1.2 Data Points**

For components of testing level 'B', undergoing a total burn-in period of 168 hours, the data points for parameter drift measurement shall be 0 hours (initial) and 168 (+24 - 0) hours (final).

For components of testing level 'C', undergoing a total burn-in period of 168 hours, the data point for post-burn-in electrical measurements shall be 168 (+24 - 0) hours.



## 7.2. FAILURE CRITERIA

### 7.2.1 Parameter Drift Failure

The acceptable delta limits are shown in Table 4 of the Detail Specification. A component of testing level 'B' shall be counted as a parameter drift failure if the changes during burn-in are larger than the delta ( $\Delta$ ) values specified.

### 7.2.2 Parameter Limit Failure

A component shall be counted as a limit failure if one or more parameters exceed the limits shown in Tables 2 or 3 of the Detail Specification.

Any component which exhibits a limit failure prior to the burn-in sequence shall be rejected and not counted when determining lot rejection.

### 7.2.3 Other Failures

A component shall be counted as a failure in any of the following cases:

- Mechanical failure.
- Handling failure.
- Lost component.

## 7.3 FAILED COMPONENTS

A component shall be considered as a failed component if it exhibits one or more of the failure modes described in Para. 7.2 of this specification.

## 7.4 LOT FAILURE

In case of lot failure, the Manufacturer shall act in accordance with the requirements of Para. 4.3.1 of this specification.

### 7.4.1 Lot Failure during 100% Testing

If the number of components failed on the basis of the failure criteria described in Para. 7.2 exceeds 5% (rounded upwards to the nearest whole number) of the number of components submitted to burn-in and electrical measurements, the lot shall be considered as failed.

If a lot is composed of groups of components of one family defined in one ESA/SCC Detail Specification, but separately identifiable for any reason, then the lot failure criteria shall apply separately to each identifiable group.



### 7.4.2 Lot Failure during Sample Testing

A lot shall be considered as failed if the number of allowable failures during sample testing, in accordance with General Inspection Level II of IEC Publication No. 410 or MIL-STD-105 and the applicable AQL as specified in the Detail Specification, is exceeded.

In the case where an LTPD to MIL-STD-414 is specified in the Detail Specification, a lot shall be considered as failed if the number of failures allowed is exceeded (see Annex I for LTPD Sampling Plan).

If a lot failure occurs in either case, a 100% testing may be performed with the lot failure criteria given in Para. 7.4.1.



 	<p>ESA/SCC Generic Specification No. 3201</p>	<p>Rev. 'C'</p>	<p>PAGE 13 ISSUE 3</p>
--	---	-----------------	----------------------------

7.5 DOCUMENTATION

Data documentation of burn-in and electrical measurements shall be in accordance with Para. 10.7 of this specification.

8. QUALIFICATION APPROVAL AND LOT ACCEPTANCE TESTS

8.1 QUALIFICATION TESTING

8.1.1 General

Qualification testing shall be in accordance with the requirements of Chart IV of this specification. The tests to Chart IV shall be performed on the specified sample, chosen at random from components which have successfully passed the tests in Charts II and III for Testing Level 'B'. This sample constitutes the qualification test lot.

The qualification test lot is divided into subgroups of tests and all components assigned to a subgroup shall be subjected to all of the tests in that subgroup, in the sequence shown.

The applicable test requirements are detailed in the paragraphs referenced in Chart IV.

The conditions governing qualification testing are given in ESA/SCC Basic Specification No. 20100, Para. 5.3 and, for the extension or renewal of qualification approval, in Para's 6.3 and 6.4.

8.1.2 Distribution within the Qualification Test Lot

A minimum sample of 100 components shall be submitted to qualification testing (Chart IV). The distribution within the sample shall be as follows:

- 50% of the lot with the minimum nominal inductance value.
- 50% of the lot with the maximum nominal inductance value.

The sample shall consist of components representative of all magnetic materials used for the construction of the range of components

The selected distribution shall be agreed with the Qualifying Space Agency.

8.2 LOT ACCEPTANCE TESTING

8.2.1 General

The sample sizes of the 3 lot acceptance levels are specified in Chart V. All components assigned to a subgroup shall be subjected to all of the tests of that subgroup in the sequence shown.



The tests to Chart V shall be performed on the specified sample which shall have been chosen, whenever possible, at random from the proposed delivery lot (but see Para. 8.2.3(b)). The applicable test requirements are detailed in the paragraphs referenced in Chart V.

As a minimum for procurement of non-qualified components, lot acceptance level 3 tests shall apply. For procurement of qualified components, lot acceptance testing shall be performed if specified in a purchase order. Procurement lots ordered with a lot acceptance test level shall be delivered only after successful completion of lot acceptance testing.

8.2.2 Distribution within the Sample for Lot Acceptance Testing

Where a Detail Specification covers a range or series of components that are considered similar, then it may be necessary that the sample for lot acceptance testing be comprised of component types so selected that they adequately represent all of the various mechanical, structural and electrical peculiarities of the procured range or series.

The distribution of the component types will normally vary from procurement to procurement and shall be as specified by the Orderer, following as closely as possible the requirements prescribed in Para. 8.1.2 of this specification.

 	<p style="text-align: center;">ESA/SCC Generic Specification No. 3201</p>	<p style="text-align: center;">Rev. 'A'</p>	<p>PAGE 14 ISSUE 3</p>
--	---	---	----------------------------

### 8.2.3 Lot Acceptance Level 3 Testing (LA3)

Lot acceptance level 3 tests are designated as the electrical subgroup and comprise electrical measurements of characteristics and tests to prove the assembly capability of the component. For LA3 testing, the following requirements and conditions shall apply:-

- (a) LA3 testing shall be performed by the Manufacturer's quality assurance personnel using dedicated quality assurance equipment whenever possible. LA3 testing shall not be a repetition of routine measurements made by production personnel during final production tests and burn-in and electrical measurements.
- (b) When tests to Tables 2 and 3 of the Detail Specification have been performed on a sample basis, then the components for LA3 testing shall be selected from this sample.
- (c) The electrical measurements for LA3 are considered to be non-destructive and therefore components so tested may form part of the delivery lot.
- (d) The solderability and terminal strength tests are considered to be destructive and therefore components so tested shall not form part of the delivery lot. Post-burn-in electrical rejects may be used for these tests.
- (e) When required in the purchase order, the Manufacturer shall notify the Orderer at least 2 working weeks before the commencement of LA3 testing. The Orderer shall indicate immediately whether or not he intends to witness the tests.

### 8.2.4 Lot Acceptance Level 2 Testing (LA2)

Lot acceptance level 2 testing shall comprise the tests for LA3 (electrical subgroup) plus tests on an endurance subgroup. For the electrical subgroup, the requirements and conditions as for LA3 (see Para. 8.2.3) shall apply.

For the endurance subgroup, the following shall apply:-

- (a) Components of testing level 'C', selected for the endurance subgroup, shall be serialised or defined by jig position prior to the tests and inspections.
- (b) The tests in this subgroup are considered to be destructive and therefore components (of testing level 'B' or 'C') so tested shall not form part of the delivery lot.

### 8.2.5 Lot Acceptance Level 1 Testing (LA1)

Lot acceptance level 1 testing shall comprise the tests for LA3 (electrical subgroup) and LA2 (endurance subgroup) plus tests on an environmental and mechanical subgroup.



For the electrical and endurance subgroups, the requirements and conditions for LA3 (see Para. 8.2.3) and LA2 (see Para. 8.2.4) respectively shall apply.

For the environmental subgroup, the following shall apply:-

- (a) Components of testing level 'C', selected for the environmental subgroup, shall be serialised or defined by jig position prior to the tests and inspections.
- (b) The tests in this subgroup are considered to be destructive and therefore components (of testing level 'B' or 'C') so tested shall not form part of the delivery lot.

## 8.3 FAILURE CRITERIA

The following criteria shall apply to qualification testing and to lot acceptance testing.

 	<p>ESA/SCC Generic Specification No. 3201</p>	<p>Rev. 'A'</p>	<p>PAGE 15 ISSUE 3</p>
--	---	-----------------	----------------------------

### 8.3.1 Environmental and Mechanical Test Failures

The following shall be counted as component failures:

- Components which fail during tests for which the pass/fail criteria are inherent in the test method, e.g. solderability, terminal strength, etc.

### 8.3.2 Electrical Failures

The following shall be counted as component failures:-

- (a) Components which, when subjected to electrical measurements on completion of environmental tests, in accordance with either Table 2 or Table 6, as specified in the Detail Specification, fail one or more of the applicable limits.
- (b) Components which, when subjected to electrical measurements at intermediate and end-points during endurance testing, in accordance with Table 6 of the Detail Specification, fail one or more of the applicable limits.
- (c) Components which, when subjected to measurement of electrical characteristics, in accordance with Tables 2 and 3 of the Detail Specification, fail one or more of the applicable limits.

### 8.3.3 Other Failures

The following additional failures may also occur during qualification testing or lot acceptance testing:-

- (a) Components failing to comply with the requirements of ESA/SCC Basic Specification No. 20500.
- (b) Lost components.

### 8.4 FAILED COMPONENTS

A component shall be considered as failed if it exhibits one or more of the failure modes detailed in Para. 8.3 of this specification.

The allowable number of failed components per subgroup, the aggregate failure constraints and the permitted distribution of such failures are shown at the foot of Charts IV and V of this specification.

When requested by the Qualifying Space Agency or the Orderer, failure analysis of failed components shall be performed by the Manufacturer and the results provided.

Failed components from successful lots shall be marked as such and be stored at the Manufacturer's plant for 24 months.

### 8.5 LOT FAILURE

A lot shall be considered as failed if the allowable number of failures according to Chart IV or V of this specification, as relevant, has been exceeded.

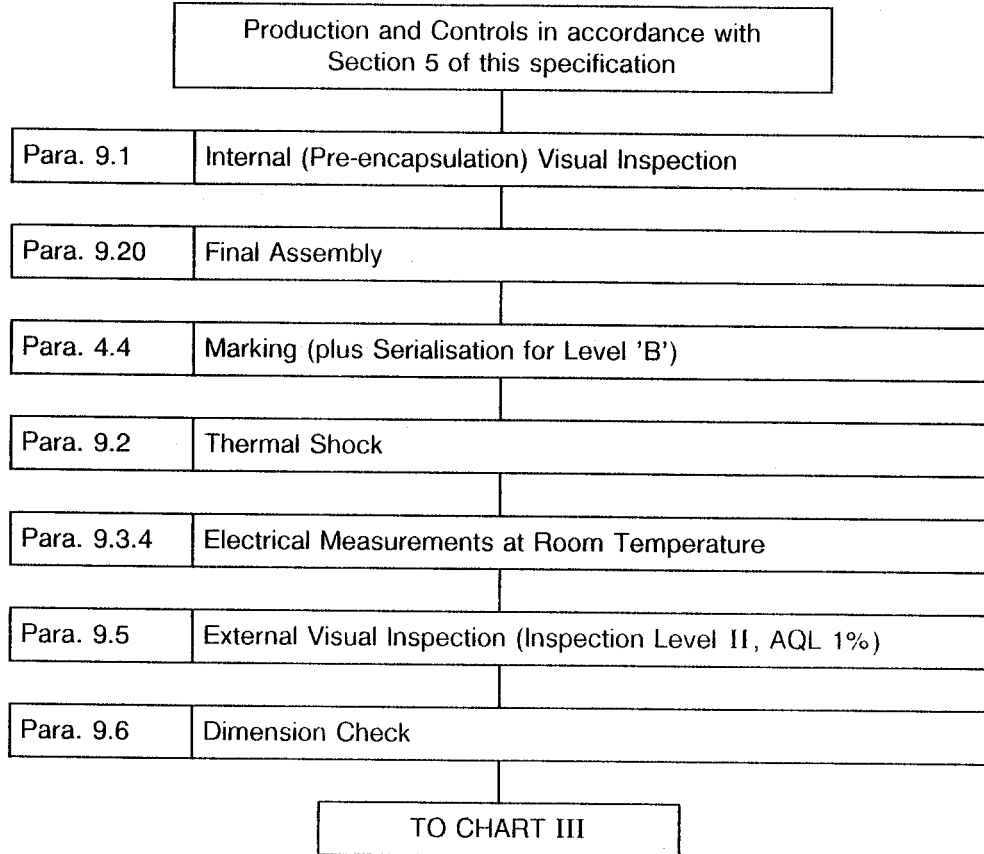
In the case of lot failure, the Manufacturer shall act in accordance with Para. 4.3.1 of this specification.

### 8.6 DOCUMENTATION

For qualification testing, the qualification test data shall be documented in accordance with the requirements of Para. 10.8 of this specification. In the case of lot acceptance testing, the data shall be documented in accordance with the requirements of Para. 10.9.

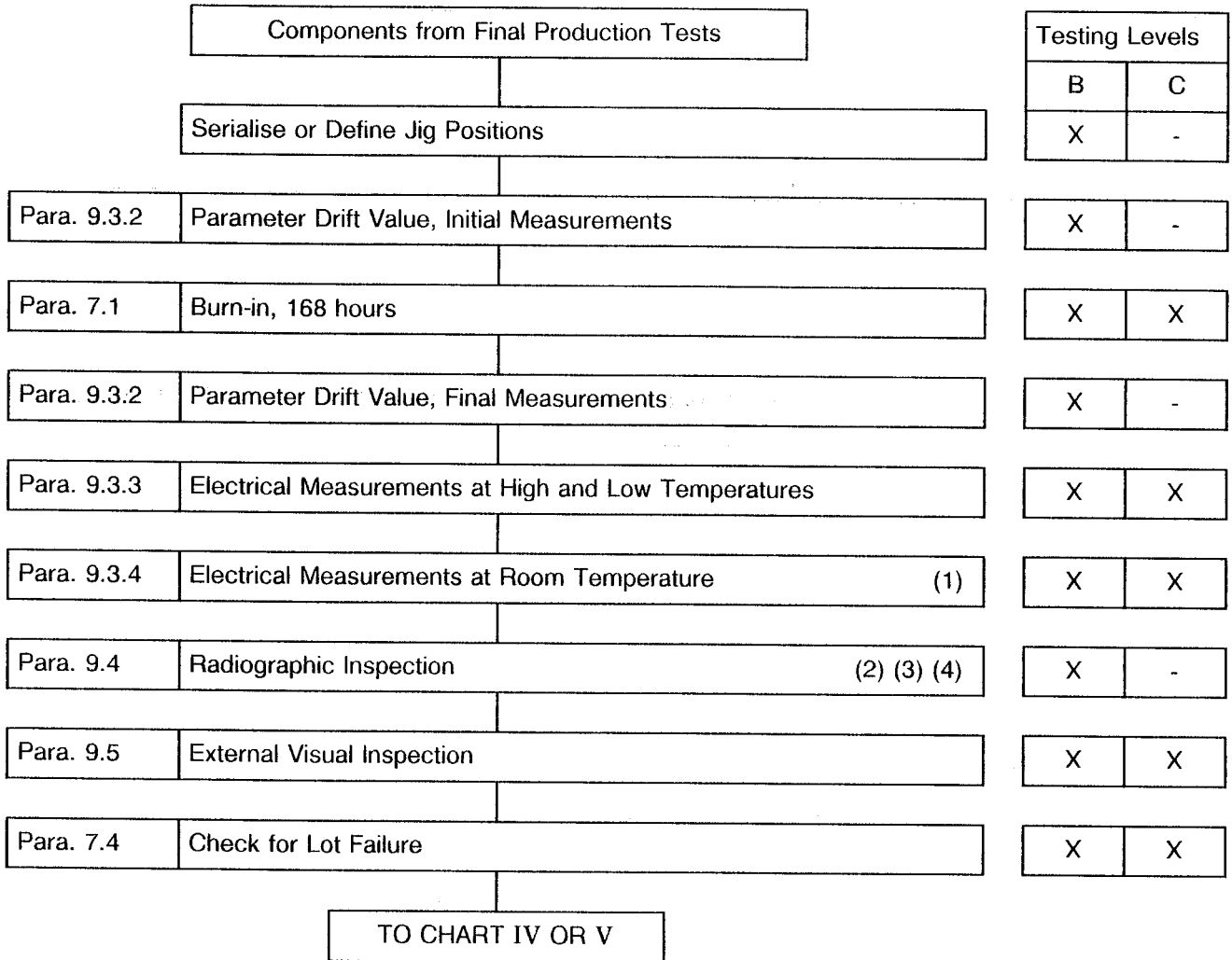


**CHART II - FINAL PRODUCTION TESTS**





**CHART III - BURN-IN AND ELECTRICAL MEASUREMENTS**

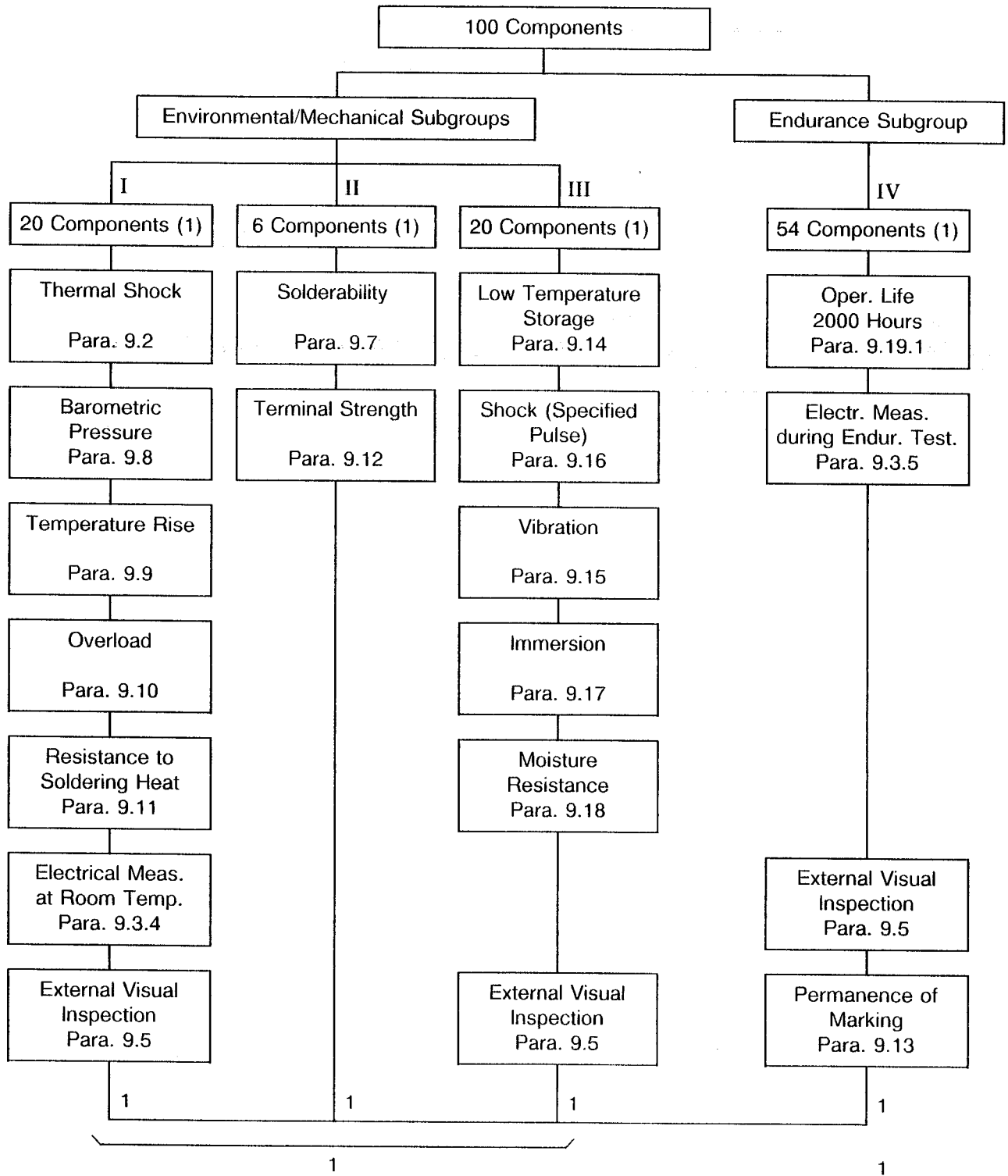


**NOTES**

1. The measurement of parameters for the purpose of drift value measurements need not be repeated for electrical measurements at room temperature.
2. Radiographic Inspection may be performed at any point during the test sequence shown in this Chart.
3. Radiographic Inspection rejects are not to be counted for lot failure.
4. Unless otherwise specified in the Detail Specification.



**CHART IV - QUALIFICATION TESTS**



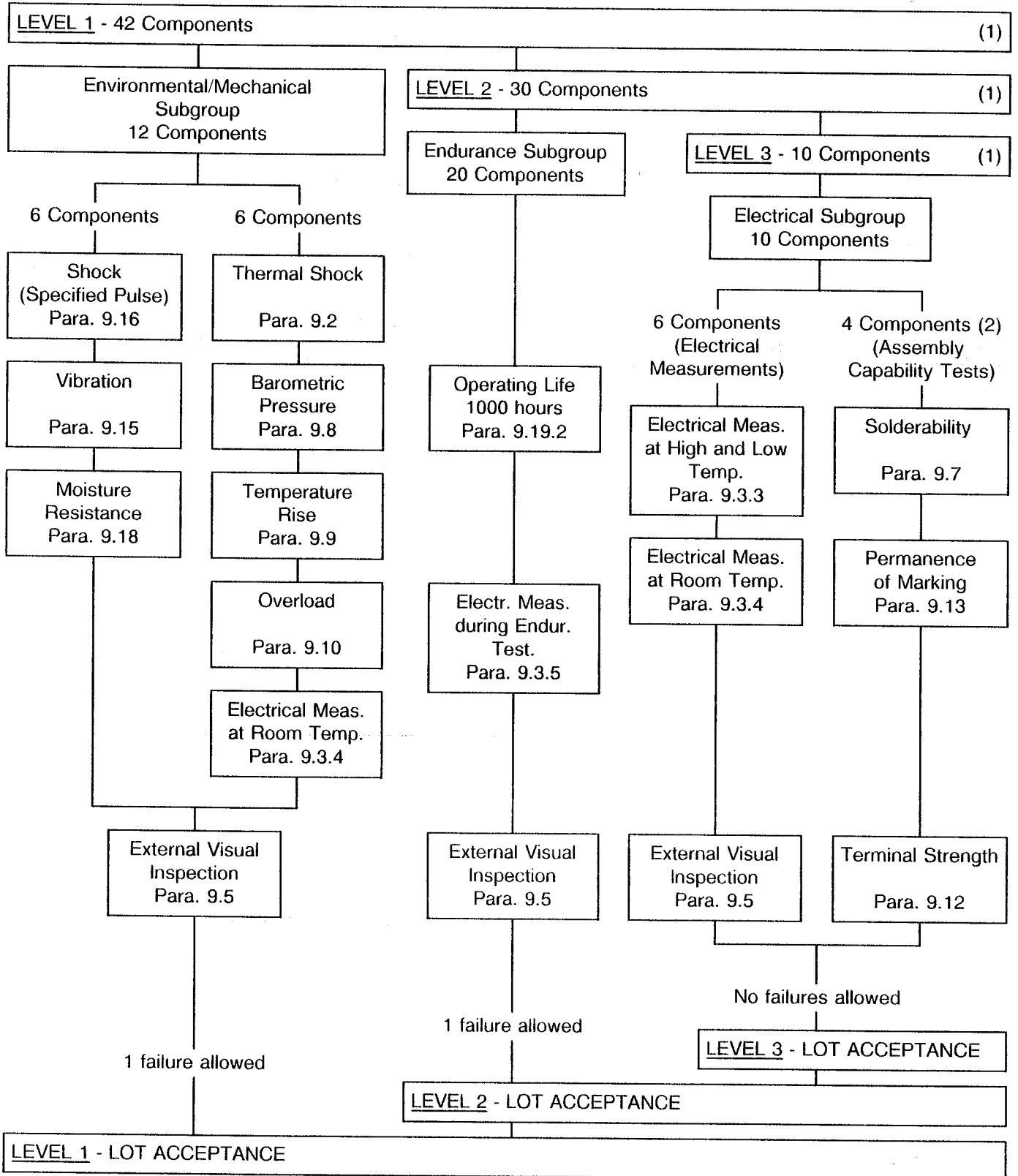
Total allowable number of failed components: 2.

**NOTES**

1. For distribution within the subgroups, see Para. 8.1.2.





**CHART V - LOT ACCEPTANCE TESTS**



**NOTES**

1. For distribution within the subgroups, see Para. 8.2.2.
2. Post-burn-in electrical rejects may be used for this test.

 	<p>ESA/SCC Generic Specification No. 3201</p>	<p>Rev. 'B'</p>	<p>PAGE 20 ISSUE 3</p>
--	---	-----------------	----------------------------

**9. TEST METHODS AND PROCEDURES**

If a Manufacturer elects to eliminate or modify a test method or procedure, the Manufacturer is still responsible for delivering components that meet all of the performance, quality and reliability requirements defined in this specification and the Detail Specification.

Documentation supporting the change shall be approved by the Qualifying Space Agency and retained by the Manufacturer. It shall be copied, when requested, to the Qualifying Space Agency.

The change shall be specified in the Detail Specification and in the P.I.D.

**9.1 INTERNAL VISUAL INSPECTION**

In accordance with ESA/SCC Basic Specification No. 20400.

**9.2 THERMAL SHOCK**

The coils shall not be loaded and shall be tested in accordance with Method 107 of MIL-STD-202. The following details shall apply:-

**During Chart II**

**(a) Test condition:**

'A-1' (25 cycles) for cylindrical coils.

'A' (5 cycles) for SMD coils.

The elevated temperature shall be the maximum operating temperature specified in Table 1(b) of the Detail Specification.

**(b) Measurements before and after cycling:** Not applicable.

**(c) Visual examination after test:** The coils shall be visually examined and there shall be no evidence of damage or loosening of the terminals.

**During Charts IV and V**

**(a) Test condition:**

'A-1' (25 cycles) for cylindrical coils.

'A-3' (100 cycles) for SMD coils.

The elevated temperature shall be the maximum operating temperature specified in Table 1(b) of the Detail Specification.

**(b) Measurements before and after cycling:** Not applicable.



**(c) Visual examination after test:** The coils shall be visually examined and there shall be no evidence of damage or loosening of the terminals.

**9.3 ELECTRICAL MEASUREMENTS**

**9.3.1 General**

For all measurements, the coils shall be mounted by their normal mounting means on the applicable test fixtures. Electrical measurements and methods shall be as follows.



 	<p>ESA/SCC Generic Specification No. 3201</p>	<p>Rev. 'B'</p>	<p>PAGE 20A ISSUE 3</p>
--	---	-----------------	-----------------------------

### 9.3.1.1 Inductance

Inductance shall be measured as specified in Para's 9.3.1.1.1 to 9.3.1.1.5 as appropriate, using one of the test methods detailed in (a), (b) or (c) below.

#### (a) True inductance

When true Inductance is specified, the following test procedure, or equivalent, shall be applied. A calibrated capacitor shall be used to tune the winding to resonance at several frequencies.



The points shall describe a straight line of added capacitance, one point of which shall be  $1/f_r^2$ , as abscissa, versus the reciprocal of the frequency squared, as ordinate, to be plotted, and true Inductance to be calculated by the following formula:-

True Inductance =  $KM$ , where

$K = 1/4\pi^2 = 0.0253$ ,

$M$  = slope of line, representing added capacitance,

$f_r$  = self-resonant frequency of the coil at the abscissa of zero capacity.

		<p style="text-align: center;">ESA/SCC Generic Specification No. 3201</p>	<p style="text-align: center;">Rev. 'A'</p>	<p style="text-align: center;">PAGE 21 ISSUE 3</p>
---	---	---	---	--

**(b) Effective inductance**

**(i) Measurement method for  $L_{cf}$**

The measurement of  $L_{cf}$  shall be performed using test fixtures TF-A to TF-E, as given in Figures I, III and V, as applicable. The appropriate test fixture shall be inserted in the Q meter coil terminals with the side showing the test fixture letter facing the capacitance terminals.

The appropriate shorting bar, conforming to Figure II, IV or V, shall be inserted into the clips of the test fixture in such a manner that the terminals rest firmly against the stops and so that the bar is centred between the test fixture terminals.

The Q meter capacitance dial shall be set at 400 picofarads (pF) and the vernier capacitance dial at zero.

The Q meter shall then be resonated, using the frequency dial, until a peak reading is obtained. The frequency shall be monitored in order to obtain an accuracy of 0.1%.

This resonant frequency value in Megahertz (MHz) shall be recorded.

The sum of the residual inductance of the Q meter and the inductance of the test fixture shall be calculated from:-

$$L_{cf} = \frac{1}{4\pi^2 f^2 C} - L_{bar}, \text{ where}$$

$L_{cf}$  = inductance in microhenries of the test fixture and residual inductance in the Q meter.

f = frequency in Megahertz.

C = capacitance in microfarads.

$$L_{bar} = 0.02\ell | 2.303 \log_{10} \frac{4\ell^{-1}}{d} + \frac{d}{2\ell} |$$

$\ell$  = length of wire in mm.

d = diameter of cross-section in mm.

**(ii) Measurement method for effective inductance**

The shorting bar detailed in (i) above shall be removed from the test fixture and the coil under test shall then be inserted in such a manner that the leads are straight and rest firmly against the stops with the unit centred between the test fixture terminals.

The Q meter frequency shall then be set to the frequency specified in Para's 9.3.1.1.1 to 9.3.1.1.4 as appropriate. The L-C dial of the Q meter shall then be turned until the resonance meter indicates a peak reading.

The inductance ( $L_d$ ) shall be read directly on the L-C dial using the inductance scale and the effective inductance of the coil (see Table 1(a) of the Detail Specification) shall be calculated from the following formula:-

$$L = L_d - L_{cf}, \text{ where}$$

L = effective inductance in microhenries of coils,

$L_d$  = inductance dial reading in microhenries,

$L_{cf}$  = correction factor for inductance of test fixture and residual inductance of the Q meter in microhenries.

**(c) Alternative Measurement Method for Effective Inductance**

The inductance shall be measured with a suitable instrument (Impedance Analyser or equivalent).

**9.3.1.1.1 Effective Inductance for Cylindrical Coils**

(Inductance 0.10 to 10.0 microhenries inclusive)

The measurements shall be performed using test fixture TF-A or TF-B of Figure I or III, as appropriate.

A Q meter such as Hewlett Packard model 260A, or equivalent, shall be used. Suitable means shall be used to calibrate the frequency dial of the Q meter within  $\pm 0.1\%$  for the applicable test frequency. Frequencies to be used for testing the various ranges of inductance shall be as follows:-

INDUCTANCE RANGE ( $\mu\text{H}$ )	TEST FREQUENCY (MHz)
0.10 to 1.0 incl.	25
Above 1.0 to 10.0 incl.	7.9

Allowance shall be made for the internal inductance of the Q meter and the test fixture ( $L_{cf}$ ) as determined in Para. 9.3.1.1(b)(i).

**9.3.1.1.2 Effective Inductance for Cylindrical Coils**  
(Inductance greater than 10 microhenries)

The measurements shall be performed as specified in Para. 9.3.1.1.1, except that no allowance shall be made for the residual inductance of the Q meter and the inductance of the test fixture ( $L_{cf}$ ). Frequencies to be used for testing various ranges of inductance shall be as follows:-

INDUCTANCE RANGE ( $\mu\text{H}$ )	TEST FREQUENCY (MHz)
Over 10.0 to 100.0 incl.	2.5
Over 100.0 to 1 000.0 incl.	0.790
Over 1 000.0 to 10 000.0 incl.	0.250
Over 10 000.0 to 100 000.0 incl.	0.079

**9.3.1.1.3 Effective Inductance for Radial Lead Coils**  
(Inductance 0.10 to 10.0 microhenries inclusive)

The measurements shall be performed as specified in Para. 9.3.1.1.1, except that test fixture TF-C, TF-D or TF-E of Figure V, as appropriate, shall be used.

**9.3.1.1.4 Effective Inductance for Radial Lead Coils**  
(Inductance greater than 10 microhenries)

The measurements shall be performed as specified in Para. 9.3.1.1.2, except that test fixture TF-C, TF-D or TF-E of Figure V, as appropriate, shall be used.

**9.3.1.1.5 Effective Inductance for SMD Coils**

The Test Frequency to be used for testing shall be as follows:-

INDUCTANCE RANGE ( $\mu\text{H}$ )		TEST FREQUENCY (MHz)
Less than	0.018	150
0.022 to	0.082	100
0.1 to	0.390	50
0.47 to	1.0	25
1.2 to	10	7.9
12 to	100	2.5
120 to	1000	0.79

The measurements shall be performed as specified in Para. 9.3.1.1(c).

**9.3.1.2 Q Factor****9.3.1.2.1 Q Factor for Cylindrical Coils**

The test shall be performed using a Q meter such as Hewlett Packard model 260A, or agreed equivalent, and Hewlett Packard Q-standard type 513A, or agreed equivalent. Suitable means shall be used to calibrate the frequency dial of the Q meter and the Q-standard within  $\pm 0.1\%$  of the applicable test frequency.

Frequencies to be used for testing the various ranges of inductance shall be as specified in Para's 9.3.1.1.1 and 9.3.1.1.2.

The appropriate test fixture as shown in Figure I, III or V, as applicable, shall be assembled to the coil terminals of the Q meter with the side showing the test fixture letter facing the capacitance terminals.

The unit under test shall then be inserted into the test clip in such a manner that the leads are straight and rest firmly against the stops and so that the unit is centred between the terminals.

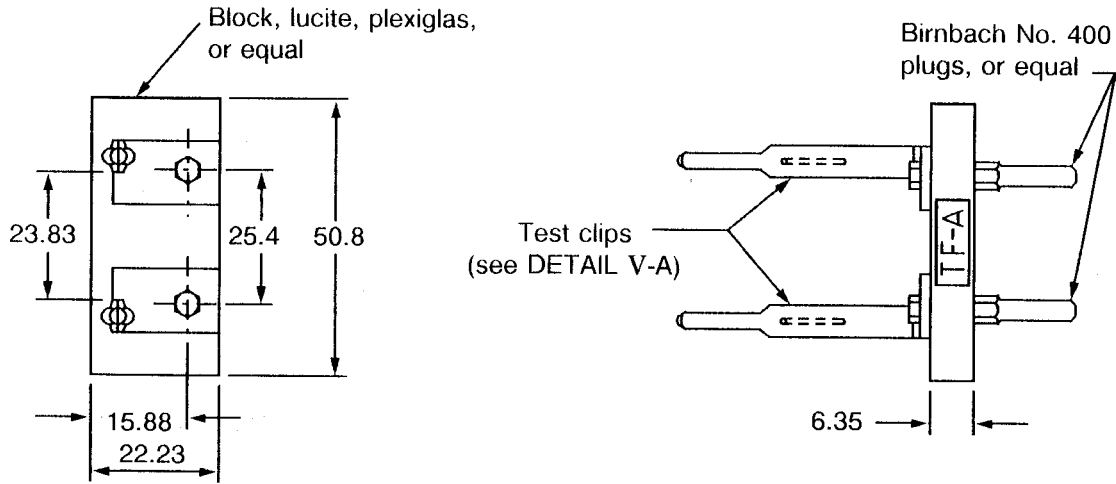
The Q shall then be read on the Q voltmeter.

**9.3.1.2.2 Q Factor for SMD Coils**

Suitable means shall be used for testing Q Factor. Frequencies to be used for testing the various ranges of inductance shall be as specified in Para. 9.3.1.1.5.



**FIGURE I - TEST FIXTURE TF-A (FOR AXIAL LEADS)**

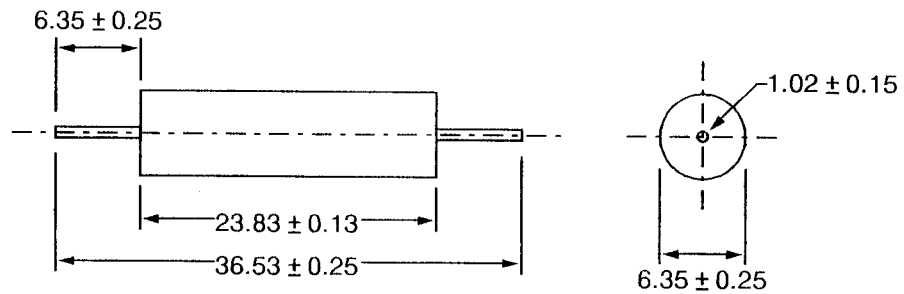


Shall be used when coil body length is 14.30mm or less

**NOTES**

1. Letters in blocks to be marked on fixture.
2. Unless otherwise specified, tolerance is  $\pm 0.13\text{mm}$ .
3. All dimensions in millimetres.

**FIGURE II - SHORTING BAR FOR TEST FIXTURE TF-A (FOR AXIAL LEADS)**



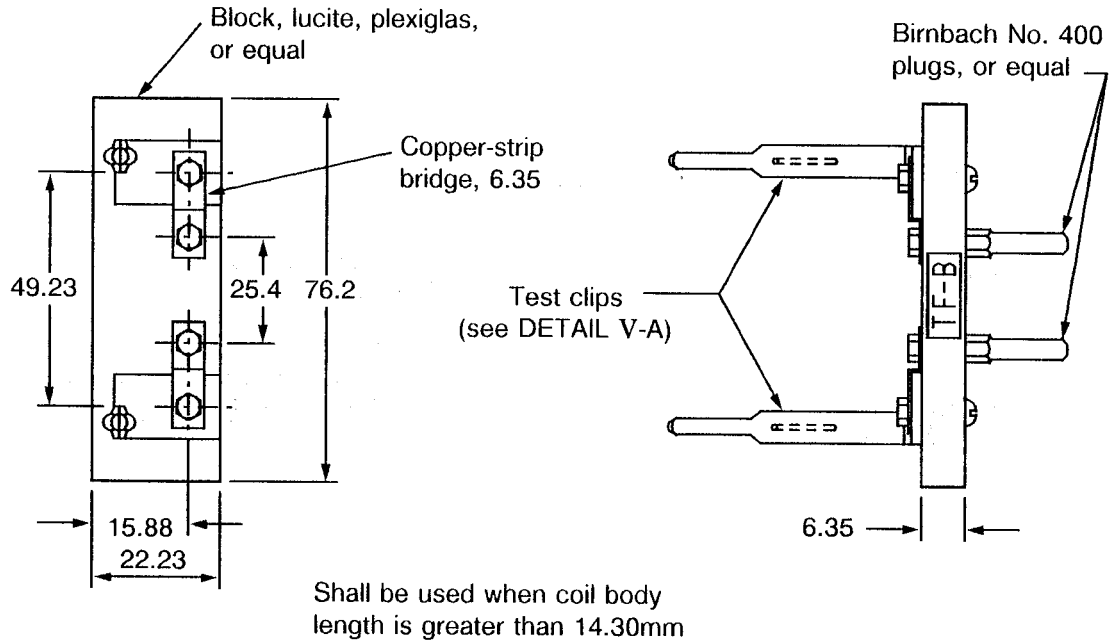
Copper or Brass

**NOTES**

1. All dimensions in millimetres.



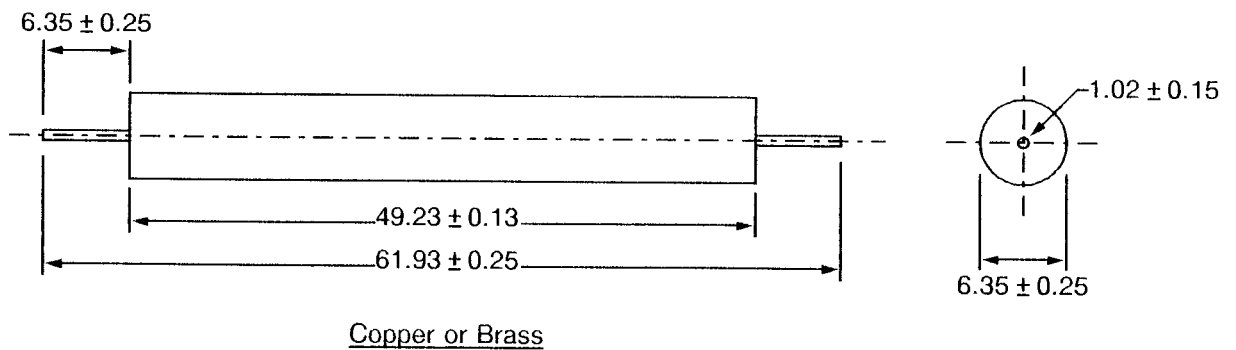
**FIGURE III - TEST FIXTURE TF-B (FOR AXIAL LEADS)**



**NOTES**

1. Letters in blocks to be marked on fixture.
2. Unless otherwise specified, tolerance is  $\pm 0.13$ mm.
3. All dimensions in millimetres.

**FIGURE IV - SHORTING BAR FOR TEST FIXTURE TF-B (FOR AXIAL LEADS)**

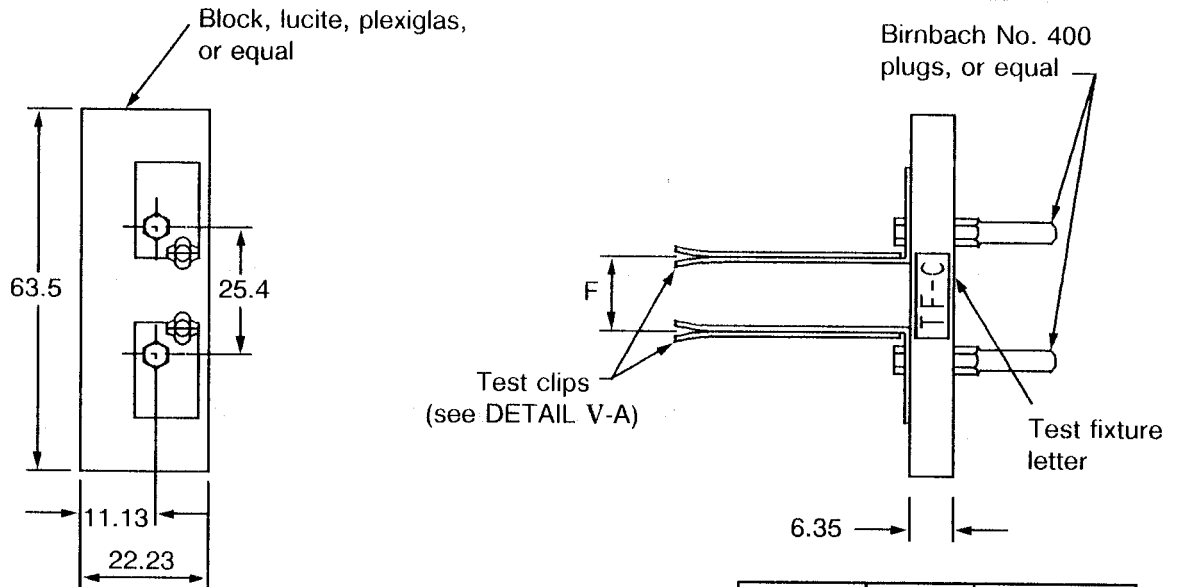


**NOTES**

1. All dimensions in millimetres.



**FIGURE V - TEST FIXTURE TF-C, TF-D AND TF-E (FOR RADIAL LEADS)**

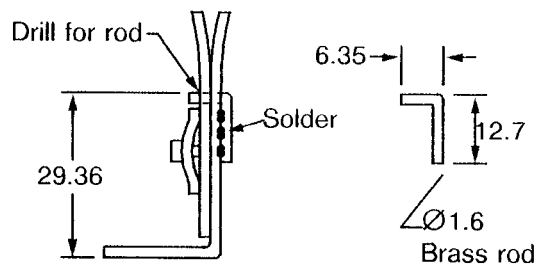


Test Fixture	Dim.	Dimension
TF-C	F	12.7
TF-D	F	15.24
TF-E	F	17.78

**NOTES**

1. Letters in blocks to be marked on fixture.
2. Unless otherwise specified, tolerance is  $\pm 0.13\text{mm}$ .
3. All dimensions in millimetres.
4. The shorting bars for use with these test fixtures shall be made from AWG size No. 18 solid copper wire, approximately 38mm long, bent as required.



**FIGURE V-A - DETAIL**



Rapid test clip R or L, or equal

**NOTES**

1. Unless otherwise specified, tolerance is  $\pm 0.13\text{mm}$ .
2. All dimensions in millimetres.

		<p style="text-align: center;">ESA/SCC Generic Specification No. 3201</p>	<p style="text-align: center;">-</p>	<p>PAGE 27 ISSUE 3</p>
--	---	---	--------------------------------------	----------------------------

### 9.3.1.3 Self-resonant Frequency

#### 9.3.1.3.1 For Cylindrical Coils

Unshielded coils shall be placed in the field of a variable frequency oscillator such as the Measurements Corporation megacycle meter, Model 59, or agreed equivalent. The oscillator shall include a device for indicating the relative amount of power absorbed from the field (e.g. a grid-dip meter).

The unit under test shall be placed on the appropriate test fixture as shown in Figures VI and VII. Units shall be suspended or supported a minimum of 38mm from any surface other than the test fixture supports or oscillator coil. The frequency of the oscillator shall be varied through the frequency range near the self-resonant frequency specified in Table 1(a) of the Detail Specification.

At any frequency in the frequency range where an abrupt increase in power absorption is indicated, the coupling between the oscillator coil and the unit under test shall be decreased by increasing the separation between the coils until a moderate dip in grid current results when tuning to this resonance. This frequency shall be considered the self-resonant frequency of the unit and shall be accurately determined by suitable means to within  $\pm 0.2\%$ .

A check shall be made for spurious indications due to a resonance not associated with the unit under test, by removing the unit from the field (at frequencies below 2.5MHz, any suitable method may be used). Coils which cannot be resonated in this manner shall be tested as specified in Para. 9.3.1.3.1.

Shielded coils shall be tested in a similar manner; however, when electrostatic shielded coils are tested, the shield of the coil shall be grounded. The following method may be used as an alternative method of measurement of shielded coils.

#### 9.3.1.3.2 Alternative Test Method

When coils under test cannot be resonated by the method specified in Para. 9.3.1.3, the test shall be performed using a Hewlett Packard Model 260A Q meter, 250A RX bridge, or agreed equivalent.

The coils shall be mounted in the appropriate test fixture as shown in Figures I, III or V, as applicable, with the test fixture letter facing the inductance terminals.

The tuning capacitor of the Q meter shall then be set to approximately 400pF and the Q circuit shall be resonated by adjusting the oscillator frequency of the Q meter.

The unit under test shall then be replaced by a shielded comparison coil having an inductance about 1/25 of that of the unit under test, or a coil that will resonate in the Q circuit at a frequency of about 10 times the initial resonant frequency.

The Q meter shall then be set to a frequency of approximately 10 times the initial resonant frequency and the Q circuit shall then be resonated at this new frequency. (This factor of 10 is based on the distributed capacitance of the unit under test being in the region of 4pF which is common for small coils. Higher distributed capacitance will lower the resonant frequency of the unit under test and a factor smaller than 10 will prevail).

The unit under test shall then be connected across the capacitance terminals of the Q meter, taking care to avoid coupling between the unit under test and the comparison coil.





The Q circuit shall then be resonated by means of the Q-tuning capacitor, observing whether the capacitance has to be increased or decreased from its previous value, in order to restore resonance.

If the capacitance has to be increased, the oscillator frequency shall be increased by 10 to 20 %. If the capacitance has to be decreased, the oscillator frequency shall be decreased by the same amount.

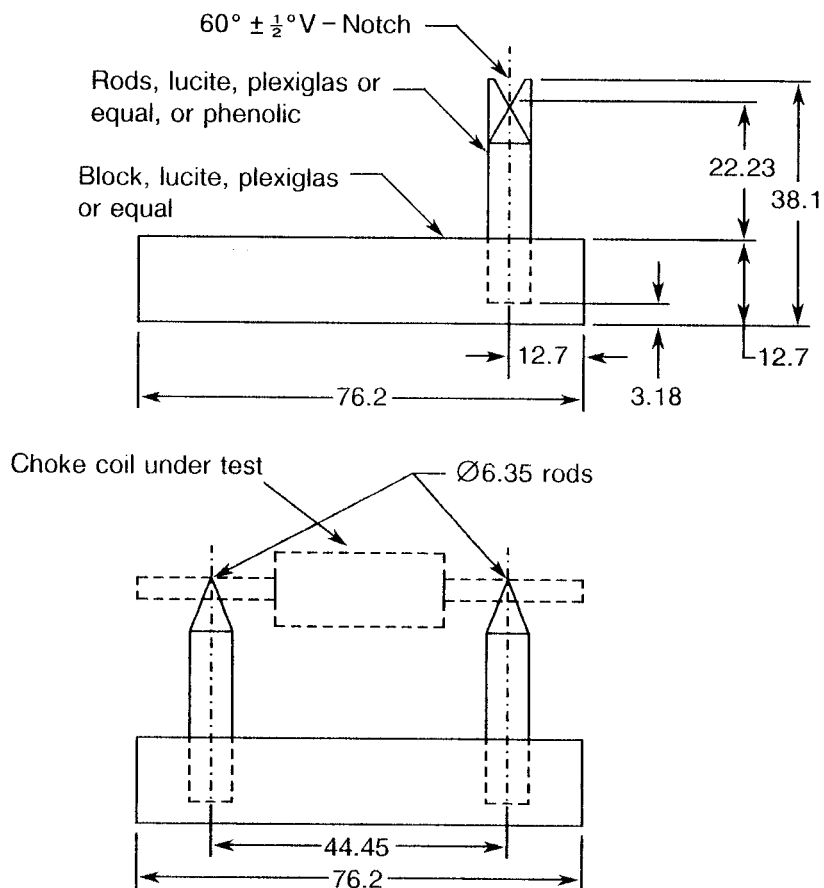
The unit under test shall then be disconnected from the Q meter and the Q circuit shall be resonated to the new frequency by means of the Q-tuning capacitor.

The previous procedure shall then be repeated while at the same time changing the oscillator frequency by smaller increments as it approaches the resonant frequency of the unit under test, until the frequency reaches a value at which the Q circuit capacitance is unchanged when the unit under test is connected or disconnected. The self-resonant frequency of the unit under test will then be the frequency of the oscillator and shall be accurately determined to within  $\pm 0.2\%$ .

9.3.1.3.3 Self-resonant Frequency for SMD Coils

When a minimum value of self-resonant frequency is specified in Table 1(a) of the Detail Specification, this minimum value shall govern.

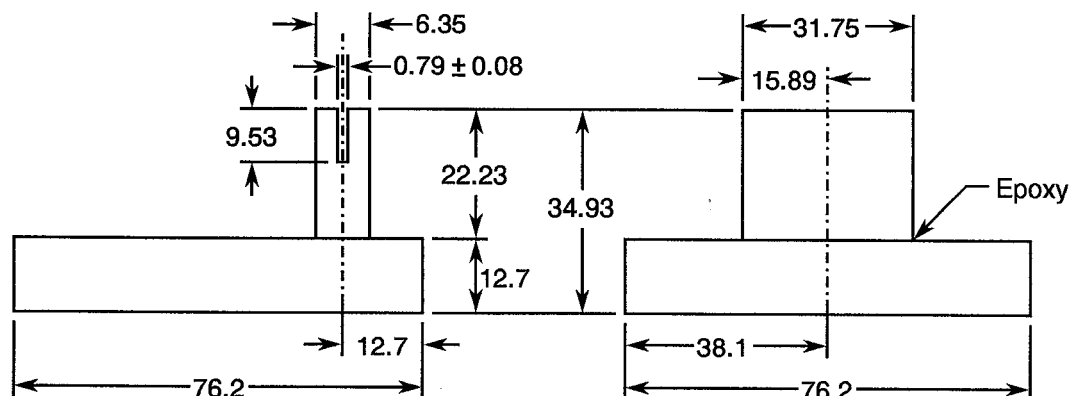
**FIGURE VI - TEST FIXTURE FOR SELF-RESONANT FREQUENCY TEST (FOR AXIAL LEADS)**



**NOTES**

1. Unless otherwise specified, tolerance is  $\pm 0.13\text{mm}$ .
2. All dimensions in millimetres.

**FIGURE VII - TEST FIXTURE FOR SELF-RESONANT FREQUENCY TEST (FOR RADIAL LEADS)**



**NOTES**

1. Material: Lucite or equivalent.
2. Unless otherwise specified, tolerance is  $\pm 0.13$ mm.
3. All dimensions in millimetres.

9.3.1.4 D.C. Resistance

Direct current (D.C.) resistance of coils shall be measured in accordance with Method 303 of MIL-STD-202. The currents used in the measurements shall not exceed the rated values for the individual coils measured.

9.3.1.5 Dielectric Withstanding Voltage

Dielectric withstanding voltage shall be tested in accordance with Method 301 of MIL-STD-202. The following details and exceptions shall apply:-

(a) **Special preparations or conditions**

1. For Cylindrical Coils

Cylindrical insulated coils shall be clamped in the trough of a 90° metallic V-block, using a metallic strap.

A 1.9mm thick layer of conductive moisture-resistance resilient material, having a resistivity of less than 1 000 Ohms per centimetre, shall be bonded to the surface of the strap next to the coils. The body of the coil shall not extend beyond the extremities of the block or resilient material.

The surface of the V-block shall be free from contamination. The coil leads shall be so positioned that the distance between the leads and any point of the V-block shall be not less than the radius of the coil minus the radius of the lead wire.

The metallic V-block shall be of non-corrosive material.

2. For SMD Coils

The contact arm shall be made of a resilient conducting material connected to ground and shall cover at least the entire surface opposite the terminals.

(b) **Magnitude of test voltage**

Unless otherwise specified in Table 1(b) of the Detail Specification, the A.C. test voltage shall be a minimum of 500Vrms for encapsulated units and 200Vrms for conformally coated units.

The leakage current shall not exceed 100 $\mu$ A unless otherwise specified in the Detail Specification.

(c) **Nature of potential**

An A.C. supply of commercial line frequency and waveform (but not more than 100 Hz).

(d) **Duration of application of test voltage:** 60 seconds.

(e) **Rate of application of test voltage:** 300V per second.

(f) **Points of application of test voltage**

1. For Cylindrical Coils

Between the coil terminals (shorted together) and the V-block, with block and metal strap grounded, unless otherwise specified in the Detail Specification.

2. For SMD Coils

The measurements shall be made between the terminals of the device (shorted together) and the contact arm.

(g) **Visual examination after test**

There shall be no sign of breakdown or flash-over during the test period and, after completion of the test, the coils shall be further visually examined for evidence of damage, arcing or breakdown.

9.3.1.6 Insulation Resistance

Insulation resistance shall be tested in accordance with Method 302 of MIL-STD-202. The following details and exceptions shall apply:-

(a) **Test condition:** 'B'.

For coils with a dielectric withstanding voltage of less than 500Vrms (see Table 1(b) of the Detail Specification), the test condition letter shall be 'A'.

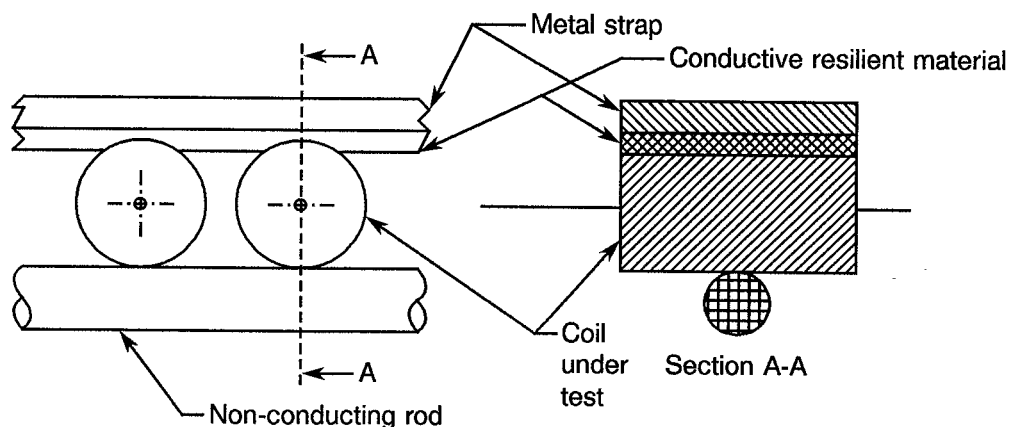
(b) **Points of measurement**

Unless otherwise specified in the Detail Specification, measurements shall be made between insulated points.

For cylindrical coils, the measurements shall be made between the coil winding and the metal strap in the coil-connecting assembly specified in Figure VIII or between the coil terminals (shorted together) and the V-block (see Para. 9.3.1.5(f)).

For SMD coils, the, the measurements shall be made between the terminals of the device (shorted together) and the contact arm.

**FIGURE VIII - COIL-CONTACTING ASSEMBLY FOR MOUNTING DURING POLARISATION**





### 9.3.2 Parameter Drift Value Measurements

At each of the relevant data points for components of testing level 'B', measurements shall be made of all parameters listed in Table 4 of the Detail Specification. All values obtained shall be recorded against serial numbers or jig positions and the parameter drift calculated.

### 9.3.3 Electrical Measurements at High and Low Temperatures

For components of testing levels 'B' and 'C', the electrical measurements at high and low temperatures shall be made in accordance with Table 3 of the Detail Specification. Where sample testing is applied, note the requirements of Para. 8.2.3(b). For testing level 'B', all values obtained shall be recorded against serial numbers or jig positions.

### 9.3.4 Electrical Measurements at Room Temperature

For components of testing levels 'B' and 'C', the measurements of electrical characteristics shall be made in accordance with Table 2 of the Detail Specification. Where sample testing is applied, note the requirements of Para. 8.2.3(b). For testing level 'B', all values obtained shall be recorded against serial numbers or jig positions.

### 9.3.5 Electrical Measurements during Endurance Testing

At each of the relevant data points specified for endurance testing, measurements shall be made of all parameters listed in Table 6 of the Detail Specification. All values obtained shall be recorded against serial numbers or jig positions and the parameter drift calculated, if required.

## 9.4 RADIOGRAPHIC INSPECTION

In accordance with ESA/SCC Basic Specification No. 20900.

## 9.5 EXTERNAL VISUAL INSPECTION

In accordance with ESA/SCC Basic Specification No. 20500.

## 9.6 DIMENSION CHECK

In accordance with ESA/SCC Basic Specification No. 20500 and the Detail Specification. To be performed on 5 samples only.

If 1 failure occurs, the complete lot shall be checked.

## 9.7 SOLDERABILITY

### 9.7.1 For Cylindrical Coils

The coils shall be tested in accordance with Method 208 of MIL-STD-202. The following details shall apply:-

(a) **Special preparation of specimens**



Sample units shall not have been soldered in any previous tests.

(b) **Number of terminations to be tested of each coil: 2.**

(c) **Depth of immersion in flux and solder**

Both terminals shall be immersed to within 1.25 mm of the coil body.

When tested as specified, the dipped portion of the terminals shall conform to the solid wire termination criteria of Method 208 of MIL-STD-202.

 	<p>ESA/SCC Generic Specification No. 3201</p>	<p>Rev. 'B'</p>	<p>PAGE 32 ISSUE 3</p>
--	---	-----------------	----------------------------

### 9.7.2 For SMD Coils

This test is not applicable to weldable terminations

#### 9.7.2.1 Procedure

Prior to the solderability test, components shall be aged with 4 hours dry heat at +125°C unless otherwise specified in the Detail Specification.

The terminals of coils shall be completely immersed. The temperature shall be  $+245 \pm 5$  °C and the duration of immersion  $5 \pm 1$  seconds unless otherwise specified in the Detail Specification.

#### 9.7.2.2 Final Examination

At least 75% of the terminations shall be covered by a smooth solder coating. The remaining 25% may contain small pin-holes or rough spots, but these shall not be concentrated in one area. When the test procedures have been carried out, the coils shall be visually examined. There shall be no evidence of damage.

### 9.8 BAROMETRIC PRESSURE

The coils shall be tested in accordance with Method 105 of MIL-STD-202. The following details and exceptions shall apply:-

#### (a) **Method of mounting**

##### 1. For Cylindrical Coils

Cylindrical insulated coils shall be clamped in the trough of a 90° metallic V-block, using a metallic strap.

A 1.9mm thick layer of conductive moisture-resistant resilient material, having a resistivity of less than 1 000 Ohms per centimetre, shall be bonded to the surface of the strap next to the coils. The body of the coil shall not extend beyond the extremities of the block or resilient material. The surface of the V-block shall be free from contamination.

The coil leads shall be so positioned that the distance between the leads and any point of the V-block shall be not less than the radius of the coil minus the radius of the lead wire. The metallic V-block shall be of non-corrosive material.

##### 2. For SMD Coils

The contact arm shall be made of resilient conducting material connected to ground and shall cover at least the entire surface opposite the terminals.



(b) **Test condition:** 'C' unless otherwise specified in the Detail Specification.

#### (c) **Tests during subjection to reduced pressure**

While the coils are still at the specified low pressure, they shall be subjected to a Dielectric Withstanding Voltage test at a minimum of 200Vrms for encapsulated units and 80Vrms for conformally coated units, unless otherwise specified in the Detail Specification.

#### (d) **Visual examination after test**

There shall be no sign of breakdown or flash-over during the test period and, after completion of the test, the coils shall be further visually examined for evidence of damage, flash-over, arcing or breakdown.

 	<p style="text-align: center;">ESA/SCC Generic Specification No. 3201</p>	<p style="text-align: center;">Rev. 'B'</p>	<p style="text-align: center;">PAGE 33 ISSUE 3</p>
--	---	---	--

9.9 TEMPERATURE RISE

The temperature rise of coils shall be determined by any suitable method, but preferably by the resistance-change method. The temperature rise shall be determined by the following procedure.

(a) **Method of Mounting**

The coils shall be suspended by their terminals during the test. They shall be separated from each other by a distance of not less than 25mm. During the test, radiant shields may be placed between units, so that overheating of one unit will not affect a nearby unit. Lead wires shall be of copper, 150mm long, and of the size AWG24 (diameter 0.64mm). The coils shall be placed in the test chamber.

For leaded coils, the coil under test shall be connected to a test fixture conforming to Figure IX, with each wire lead wrapped 1 turn around the test fixture terminal and soldered to the terminal for uniform low contact resistance. The test fixture with the attached coil shall then be placed in a test chamber.

(b) **Ambient Test Temperature**

The test chamber shall be free of test area draughts and direct thermal radiation. A temperature indicating device with an accuracy of  $\pm 0.5^{\circ}\text{C}$  shall be located in the area surrounding the coil under test, but not where it will be influenced by the temperature rise of the coil.

The test chamber shall then be stabilised at room temperature without forced-air ventilation or any means of component cooling.

(c) **Initial Measurements**

The D.C. resistance ( $r$ ) shall be measured with one-tenth rated direct current applied at the specified ambient temperature ( $t$ ). When the resistance of the coil is stabilised, the resistance value shall be recorded.

The ammeter-voltmeter method may be used for determining this resistance, provided that the accuracy of these meters is  $\pm 0.5\%$  or better and the resistance of the voltmeter is at least 20 000 ohms per volt.

(d) **Test Conditions**

The rated direct current specified in Table 1(b) of the Detail Specification shall then be applied to the coil under test, using a stable current source such as a storage battery. Forced-air circulation shall be shut off when rated current is applied.

(e) **Final Measurements**

When the resistance of the winding, measured at 5 minute intervals, remains constant, the temperature of the winding shall be measured. If the power is removed, this temperature measurement shall be made within 30 seconds of the removal of power.

When the resistance of the coil is stabilised with rated current applied, the resistance ( $R$ ) and the test chamber temperature ( $T$ ) shall be recorded.

The temperature rise ( $\Delta T$ ) shall be calculated by the following formula:-

$$\Delta T = \frac{(R - r)}{r} (t + 234.5) - (T - t), \text{ where:-}$$

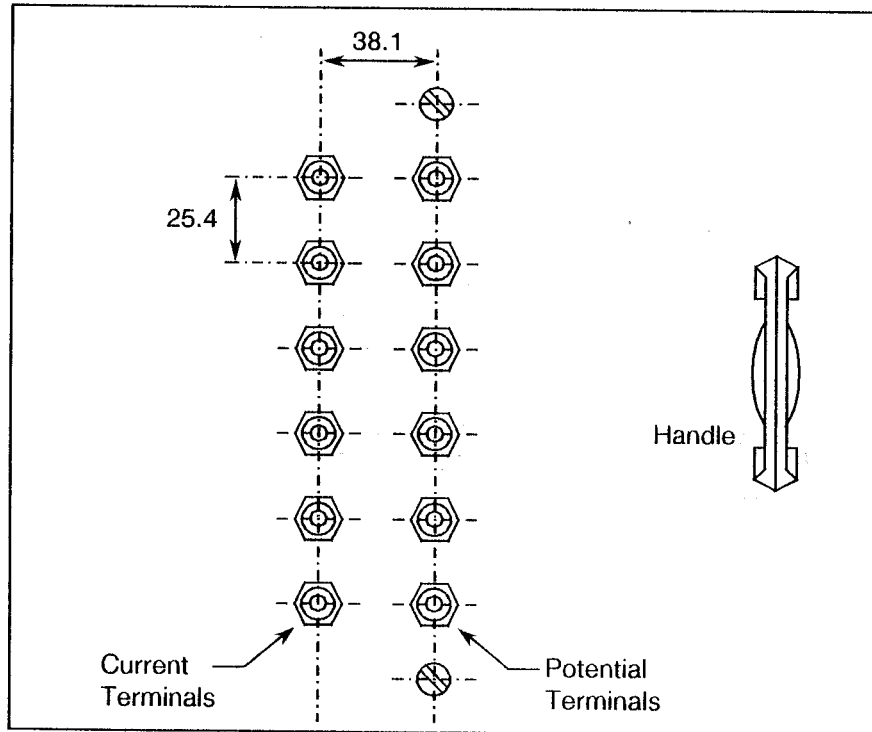
- $\Delta T$  = Temperature rise in  $^{\circ}\text{C}$  above the specified ambient temperature of the coil under test.
- $R$  = Resistance of coil in ohms with rated direct current applied at temperature ( $T + \Delta T$ ).
- $r$  = Resistance of coil in ohms at temperature ( $t$ ), the specified ambient temperature.
- $t$  = Stabilised specified ambient temperature in  $^{\circ}\text{C}$  of the coil under test with one-tenth current applied.
- $T$  = Ambient temperature in  $^{\circ}\text{C}$  (at the time forced-air circulation is shut off) with rated D.C. current applied.  $T$  shall not differ from  $t$  by more than  $5^{\circ}\text{C}$ .

(f) **Limit**

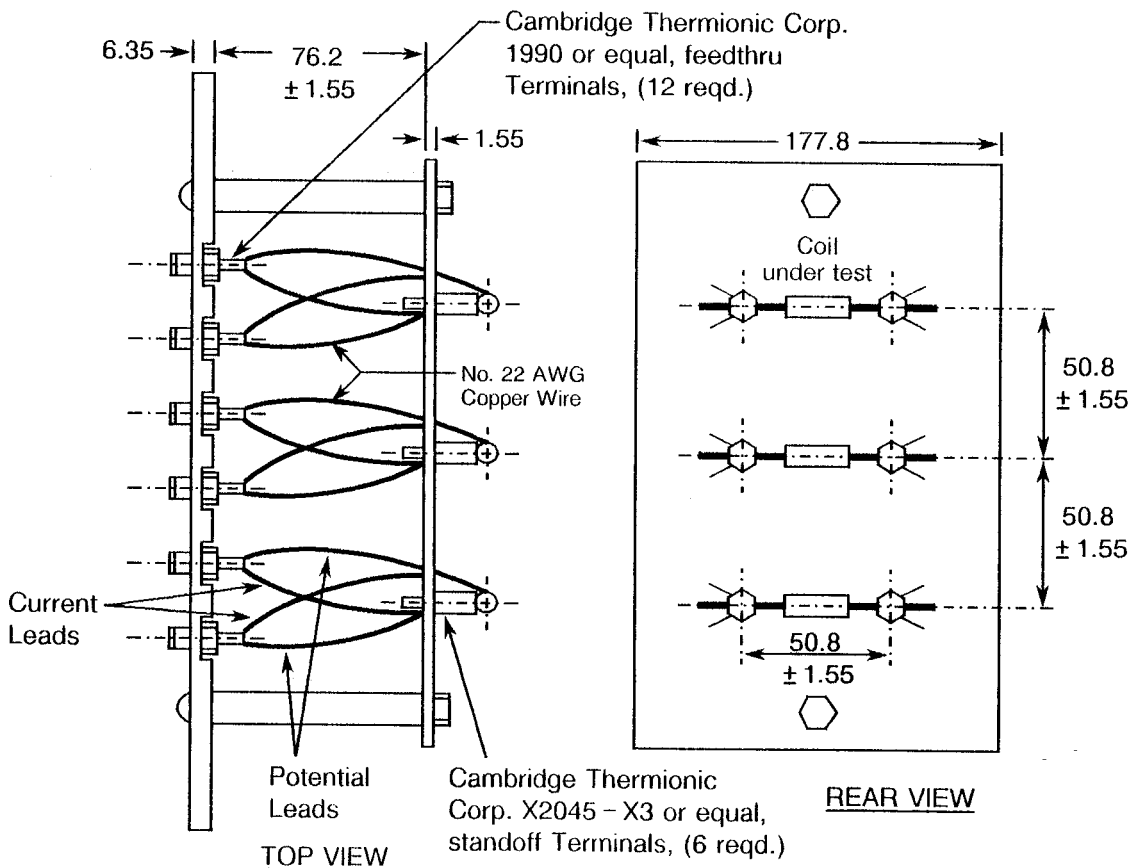
Unless otherwise specified in the Detail Specification, the temperature rise shall not exceed  $25^{\circ}\text{C}$ .



**FIGURE IX - TEST FIXTURE FOR TEMPERATURE RISE TEST ON INSULATED COILS**



**FRONT VIEW**





**TOP VIEW**

**REAR VIEW**

**NOTES**

1. All dimensions in millimetres.

 	<p style="text-align: center;">ESA/SCC Generic Specification No. 3201</p>	<p style="text-align: center;">Rev. 'B'</p>	<p style="text-align: right;">PAGE 35 ISSUE 3</p>
--	---	---	---

9.10 OVERLOAD

A direct current equivalent to 1.5 times the rated current specified in the Detail Specification shall be applied to the windings for a period of 5 minutes.

After the test, the coils shall be examined and there shall be no evidence of cracked cases, charred windings, distorted or softened insulation or loose windings or terminals.

After a minimum of 24 hours, electrical measurements at room temperature shall be performed and shall meet the requirements to Table 6 of the Detail Specification.

9.11 RESISTANCE TO SOLDERING HEAT

Terminals to be used for soldered connections shall be tested in accordance with Method 210 of MIL-STD-202. The following details and exceptions shall apply:-

(a) **Special preparation of specimens**

Sample units shall not have been soldered in any previous tests.

(b) **Depth of immersion in molten solder**

To a minimum of 6.35mm from the nearest insulating material or to one-half of the exposed length of the terminal, whichever point is closer to the insulating material. Terminals of SMD coils shall be completely immersed.

(c) **Test condition: 'A'.**

'D' for SMD Coils (+260°C, 20s).

(d) **Cooling time prior to examination after test**

Until the soldered terminals return to room ambient temperature.

(e) **Final measurements**

The electrical characteristics shall be measured as specified in Para. 9.3.4. The values shall not exceed the limits prescribed in Table 6 of the Detail Specification.

(f) **Visual examination after test**

The coils shall be visually examined and there shall be no evidence of damage or loosening of the terminals.

9.12 TERMINAL STRENGTH

9.12.1 For Cylindrical Coils

The coils shall be tested in accordance with Method 211 of MIL-STD-202. The following details and exceptions shall apply:-

(a) **Pull test (all terminals)**

(1) Test condition: 'A'.

(2) Applied force: 22(+1-0) Newtons for 5 ± 1 seconds in a direction perpendicular to the leads in the direction of the axes of the terminations.



(b) **Twist test (solid wire lead terminals)**

This includes axial and radial lead terminals, but excludes printed circuit terminals.

(1) Test condition: 'D'.

(2) Number of bends: 5.



		<p>ESA/SCC Generic Specification No. 3201</p>	<p>-</p>	<p>PAGE 36 ISSUE 3</p>
--	---	---	----------	----------------------------

(c) **Torque test (all other terminals)**

This excludes solid wire axial and radial lead terminals and printed circuit terminals.

(1) Test condition: 'E'.

(2) Applied force: 2.7 cm.N.

(d) **Examination after test**

The coils shall be examined after test and there shall be no winding discontinuity, no loosening or rupturing of the terminals and no evidence of other damage.

9.12.2 For SMD Coils

(a) **Preparation of specimens**

SMD coils shall be mounted on a suitable substrate. The test substrate shall be such that it shall not influence the results of any test. The metallised land areas shall be of proper spacing so that adjacent coils do not affect one another. During soldering, the period and the high temperature shall not exceed the maximum values specified in the Detail Specification.

(b) **Procedure**

A force of 5.0N shall be applied normal to the line joining the terminations and in a plane parallel to the substrate. The force shall be applied progressively, without any shock, and shall be maintained for a period of  $10 \pm 1$  seconds.

(c) **Final examination**

The coils shall be visually examined and there shall be no evidence of damage.

9.13 PERMANENCE OF MARKING

In accordance with ESA/SCC Basic Specification No. 24800.

9.14 LOW TEMPERATURE STORAGE

(a) **Mounting**

Coils shall be mounted by their normal mounting means in such a manner that there is at least 25.4 mm of free air space around each coil and in such a position with relation to the airstream that the mounting offers substantially no obstruction to the airflow across and around the coil.

The SMD coils shall be mounted as specified in Para. 9.12.2(a).

(b) **Procedure**

Coils shall be placed in a cold chamber at  $-65(+2-0)$  °C or at the minimum storage temperature specified in Table 1(b) of the Detail Specification.

1. For Cylindrical Coils

96 hours after the coils have reached this temperature, the temperature of the chamber shall be gradually increased to room temperature within a period of no more than 8 hours.

2. For SMD Coils

After 1 hour of stabilisation at this temperature, full rated D.C. current shall be applied for  $45(+5-0)$  minutes. Then  $15(+5-0)$  minutes after the removal of the current, the coils shall be removed from the chamber and maintained at room temperature for approximately 24 hours.

(c) **Visual examination after test**

The coils shall be visually examined and there shall be no evidence of cracks or other damage.

**9.15**     **VIBRATION**

The coils shall be tested in accordance with Method 204 of MIL-STD-202. The following details and exceptions shall apply:-

**(a) Mounting**

The coils shall be securely fastened by their normal mounting means. Units which are normally supported by their wire leads shall be mounted and soldered to rigidly supported terminals, so spaced that the length of each lead is 6.35mm from the coil body.

**(b) Test condition: 'D'.****(c) Measurements during vibration**

During Vibration, measurements shall be made to determine electrical discontinuity. The accuracy of the detection equipment shall be sufficient to detect any electrical discontinuity of 0.1ms or longer duration.

**(d) Examination after test**

The coils shall be visually examined and there shall be no evidence of damage. Winding continuity shall be checked by any suitable means that will not introduce currents in excess of the rated value.

**9.16**     **SHOCK (SPECIFIED PULSE)**

The coils shall be tested in accordance with Method 213 of MIL-STD-202. The following details shall apply:-

**(a) Mounting method**

Coils shall be mounted with relation to the test equipment in such a manner that the stress applied is in the direction which would be considered as most detrimental.

Cylindrical insulated coils shall be soldered to rigidly supported terminals at a point so spaced that the length of each lead is 6.35mm from the coil body.

**(b) Test condition: 'I'.****(c) Examination after test**

The coils shall be visually examined and there shall be no evidence of damage. Winding continuity shall be checked by any suitable means that will not introduce currents in excess of the rated value.

**9.17**     **IMMERSION**



The coils shall be tested in accordance with Method 104 of MIL-STD-202. The following details shall apply:-

**(a) Test condition: 'B'.****(b) Final measurements**

Winding continuity shall be checked by any suitable means that will not introduce currents in excess of the rated value. The components shall be submitted to the dielectric withstanding voltage test specified in Para. 9.3.1.5 at 90% of the test voltage specified in the Detail Specification and also to the insulation resistance test specified in Para. 9.3.1.6. The values shall not exceed the limits prescribed in Table 6 of the Detail Specification.

**(c) Visual examination after test**

The coils shall be visually examined and there shall be no evidence of flow of impregnating material from the case, corrosion or other damage.

 	<p>ESA/SCC Generic Specification No. 3201</p>		<p>PAGE 38 ISSUE 3</p>
--	---	--	----------------------------

9.18 MOISTURE RESISTANCE

The coils shall be tested in accordance with Method 106 of MIL-STD-202. The following details shall apply:-

(a) **Mounting**

1. For Cylindrical Coils

The coils shall be mounted on racks. Cylindrical insulated coils shall be soldered by their leads to rigid mounts or terminal lugs. The spacing of the mounts or terminal lugs shall be such that the length of each coil lead is approximately 6.35mm measured from the edge of the supporting terminal to the coil body.

For polarisation, the coils shall be covered with a flat, corrosion resistant metal strap with the width of the strap equal to the length of the coils and of sufficient thickness to be rigid. A 1.9mm thick layer of conductive moisture-resistant resilient material, having a resistivity of less than 1 000 Ohms/cm, shall be bonded to the surface of the strap next to the coils. Sufficient contact pressure shall be maintained by applying a compressive non-conducting rod held beneath the coils as shown in Figure VIII of this specification. The mounting strap may be used to cover one or more coils at a time. All mounting straps shall be removed to perform steps 7a and 7b and shall be replaced prior to returning the coils to the humidity chamber.

2. For SMD Coils

The SMD coils shall be mounted as specified in Para. 9.12.2(a).

(b) **Thermal shock**

Before starting the moisture resistance test, a thermal shock test shall be performed in accordance with Method 107 of MIL-STD-202, Test condition 'A', except that: No measurements shall be performed before cycling. The elevated temperature shall be the maximum operating temperature as specified in Table 1(b) of the Detail Specification.

(c) **Polarisation**

Unless otherwise specified in the Detail Specification, a polarising voltage of 100 Volts d.c. shall be applied during Steps 1 to 6 inclusive. The voltage shall be positive in respect to the mounting hardware or case.

For other type coils and units having no mounting hardware, the polarising voltage shall be applied as specified in the Detail Specification.

(d) **Final measurements**



Unless otherwise specified in the Detail Specification, the units shall be removed to ambient room conditions after the 1.5 to 3.5-hour conditioning period. Within 30 minutes of removal, the dielectric withstanding voltage test and the insulation resistance test shall be performed in accordance with Para's 9.3.1.5 and 9.3.1.6 respectively.

The values shall not exceed the limits prescribed in Table 6 of the Detail Specification.

Within 1 hour of these measurements, the electrical characteristics shall be measured as specified in Para. 9.3.4. The values shall not exceed the limits prescribed in Table 6 of the Detail Specification.

(e) **Visual examination after test**

The coils shall be visually examined and there shall be no evidence of corrosion.

		<p style="text-align: center;">ESA/SCC Generic Specification No. 3201</p>	<p style="text-align: center;">-</p>	<p>PAGE 39 ISSUE 3</p>
--	---	---	--------------------------------------	----------------------------

9.19 OPERATING LIFE

9.19.1 Operating Life during Qualification Testing

MIL-STD-202, Test Method 108.

(a) **Duration:** 2000 hours.

(b) **Method of Mounting**

1. Wire-lead terminal coils

Supported by wire leads mounted by lightweight push-post terminals on each side of the body. The effective length of each terminal shall be 13mm minimum. The panel racks or breadboarding device shall be equipped with current-sensing terminals. Coils shall be so arranged that the temperature of any one coil does not appreciably influence the temperature of any other coil.

2. All other terminals

Supported as specified in the Detail Specification. Coils shall be so arranged that the temperature of any one coil does not appreciably influence the temperature of any other coil.

3. For SMD Coils

The SMD coils shall be mounted as specified in Para. 9.12.2(a).

(c) **Ambient test temperature**

As specified in the Detail Specification.

(d) **Operating conditions**

100% rated cyclic loaded conditions, 90 minutes 'ON' and 30 minutes 'OFF' at the applicable ambient test temperature. 'ON' time shall be three-fourths of the total lapsed time.

(e) **Data points**

Measurements at intermediate and end-points in accordance with Table 6 of the Detail Specification at 0, 1000 ± 48 and 2000 ± 48 hours.

In the case where Table 6 specifies "changes", the drift shall always be related to the 0-hour measurement.

The coils shall be stabilised at room temperature for a minimum of 30 minutes after removal from the test chamber prior to the performance of measurements. Coils shall remain at room temperature for no longer than is necessary to perform the required measurements before return to the test chamber.

9.19.2 Operating Life during Lot Acceptance Testing



MIL-STD-202, Test Method 108.

(a) **Duration:** 1 000 hours.

(b) **Method of mounting**

1. Wire-lead terminal coils

Supported by wire leads mounted by lightweight push-post terminals on each side of the body. The effective length of each terminal shall be 13mm minimum. The panel racks or breadboarding device shall be equipped with current-sensing terminals. Coils shall be so arranged that the temperature of any one coil does not appreciably influence the temperature of any other coil.

		<p>ESA/SCC Generic Specification No. 3201</p>	<p>-</p>	<p>PAGE 40 ISSUE 3</p>
--	--	---	----------	----------------------------

2. All other terminals

Supported as specified in the Detail Specification. Coils shall be so arranged that the temperature of any one coil does not appreciably influence the temperature of any other coil.

3. For SMD Coils

The SMD coils shall be mounted as specified in Para. 9.12.2(a).

(c) **Ambient test temperature**

As specified in the Detail Specification.

(d) **Operating conditions**

100% rated cyclic loaded conditions, 90 minutes 'ON' and 30 minutes 'OFF' at the applicable ambient test temperature. 'ON' time shall be three-fourths of the total lapsed time.

(e) **Data points**



Measurements at end-points in accordance with Table 6 of the Detail Specification at 0 and  $1\ 000 \pm 48$  hours.

In the case where Table 6 specifies "changes", the drift shall always be related to the 0-hour measurement.

The coils shall be stabilised at room temperature for a minimum of 30 minutes after removal from the test chamber prior to the performance of measurements.

9.20 FINAL ASSEMBLY

Final Assembly shall be performed in accordance with the Process Identification Document (P.I.D.).

 	<p style="text-align: center;">ESA/SCC Generic Specification No. 3201</p>	<p style="text-align: center;">Rev. 'C'</p>	<p style="text-align: center;">PAGE 41 ISSUE 3</p>
---	---	---	--

## 10. DATA DOCUMENTATION

### 10.1 GENERAL

For the qualification approval records and with each component delivery, a data documentation package is required. Depending on the testing level and lot acceptance level specified for the component, this package shall be compiled from:-

- (a) Cover sheet (or sheets).
- (b) List of equipment (testing and measuring).
- (c) List of test references.
- (d) Special in-process control test data (when required by the Detail Specification).
- (e) Final production test data (Chart II) (but see Para. 10.6).
- (f) Burn-in and electrical measurement data (Chart III).
- (g) Qualification test data (Chart IV).
- (h) Lot acceptance test data (Chart V) (when applicable).
- (i) Failed component list (see Paras. 7.3 and 8.4) and failure analysis report (see Para. 8.4).
- (j) Certificate of Conformity.
- (k) Radiographic inspection photographs.

Items (a) to (k) inclusive shall be grouped, preferably as subpackages and, for identification purposes, each page shall include the following information:

- ESA/SCC Component Number.
- Manufacturer's name.
- Lot identification.
- Date of establishment of the document.
- Page number.

#### 10.1.1 Qualification Approval



In the case of qualification approval, the items listed in Para. 10.1 (a) to (k) less item (h) are required.

#### 10.1.2 Testing Level 'B'

##### 10.1.2.1 Qualified Components

For deliveries of qualified components, the following documentation shall be supplied:-

- (a) Cover sheet (if all of the information is not included on the Certificate of Conformity).
- (b) Certificate of Conformity (including range of delivered serial numbers).
- (c) Attributes record of measurements, tests and inspections performed in Chart II, Chart III (including PDA figure) and Chart V (where applicable).
- (d) Failed components list.

		<p style="text-align: center;">ESA/SCC Generic Specification No. 3201</p>	<p style="text-align: center;">Rev. 'C'</p>	<p style="text-align: center;">PAGE 41A ISSUE 3</p>
--	--	---	---	---

#### 10.1.2.2 Unqualified Components

For deliveries of unqualified components, the documentation to be supplied shall be in accordance with Para. 10.1.2.1 plus the following:-

- (a) Read and record data from Chart III.
- (b) Special in-process control data (where applicable).
- (c) Failure analysis report on failed components.

#### 10.1.3 Testing Level "C"

##### 10.1.3.1 Qualified Components

For deliveries of qualified components, the following documentation shall be supplied:-

- (a) Certificate of Conformity.



##### 10.1.3.2 Unqualified Components

For deliveries of unqualified components, the documentation to be supplied shall be in accordance with Para. 10.1.3.1 plus the following:-

- (a) Cover sheet (if all of the information is not included on the Certificate of Conformity).
- (b) Attributes record of all measurements, tests and inspections performed in Charts II, III and V (when applicable).
- (c) Failed components list (including Failure Analysis Report).
- (d) Special in-process control data (when applicable).

#### 10.1.4 Data Retention/Data Access

If not delivered, all data shall be retained by the Manufacturer for a minimum of 5 years during which time it shall be available to the Qualifying Space Agency and the Orderer, if requested, for review. The Manufacturer shall deliver variables Data/Reports to the Orderer if required by the Purchase Order.

 	<p style="text-align: center;">ESA/SCC Generic Specification No. 3201</p>	<p style="text-align: center;">Rev. 'A'</p>	<p style="text-align: right;">PAGE 42 ISSUE 3</p>
---	---	---	---

**10.2 COVER SHEET(S)**

The cover sheet(s) of the data documentation package shall include as a minimum:-

- (a) Reference to the Detail Specification, including issue and date.
- (b) Reference to the applicable ESA/SCC Generic Specification, including issue and date.
- (c) Component type and number.
- (d) Lot identification.
- (e) Range of delivered serial numbers or jig positions (for components of testing level 'B').
- (f) Number of purchase order.
- (g) Information relative to any additions to this specification and/or the Detail Specification.
- (h) Manufacturer's name and address.
- (j) Location of the manufacturing plant.
- (k) Signature on behalf of Manufacturer.
- (l) Total number of pages of the data package.

**10.3 LIST OF EQUIPMENT USED**

A list of equipment used for tests and measurements shall be prepared, if not in accordance with the data given in the Process Identification Document (P.I.D.). Where applicable, this list shall contain inventory number, Manufacturer's type number, serial number, etc. This list shall indicate for which tests such equipment was used.

**10.4 LIST OF TEST REFERENCES**

This list shall include all Manufacturer's references or codes which are necessary to correlate the test data provided with the applicable tests specified in the tables of the Detail Specification.

**10.5 SPECIAL IN-PROCESS CONTROL DATA**

As specified in the Detail Specification.


**10.6 FINAL PRODUCTION TEST DATA (CHART II)**

A test result summary shall be compiled showing the total number of components submitted to, and the total number rejected after, each of the following tests:

- Internal visual inspection (Para. 9.1).
- Thermal shock (Para. 9.2).
- Electrical measurements at room temperature (Para. 9.3.4).
- External visual inspection (Para. 9.5).
- Dimension check (Para. 9.6).

The final production test data shall form an integral part of the data documentation package, but it is not a mandatory requirement that it be delivered with the qualification lot or delivery lot. However, the data package to be delivered shall contain the information as detailed in Paras. 10.1.2 and 10.1.3 or at least shall contain a list of final production tests actually performed and a certification that the data is available for review.



	<p style="text-align: center;">ESA/SCC Generic Specification No. 3201</p>	<p style="text-align: center;">Rev. 'A'</p>	<p style="text-align: right;">PAGE 43 ISSUE 3</p>
--	---	---	---

10.7 BURN-IN AND ELECTRICAL MEASUREMENT DATA (CHART III)

10.7.1 Testing Level 'B'

For components of testing level 'B', all data shall refer to the relevant serial numbers or jig positions. Against these serial numbers or jig positions, data shall be recorded of the following:-

- (a) 0-hour measurement for burn-in.
- (b) 168-hour measurement for burn-in.
- (c) Delta values after burn-in.
- (d) Values obtained during measurements at high and low temperatures (Table 3 of the Detail Specification).
- (e) Values obtained during measurements of electrical characteristics (Table 2 of the Detail Specification).
- (f) Failures during external visual inspection.
- (g) Photographs from radiographic inspection, including those of reject components.

10.7.2 Testing Level 'C'

For components of testing level 'C', a test result summary (i.e. the total number of components subjected to, and the total number rejected from, each of the tests and inspections) shall be prepared.

10.8 QUALIFICATION TEST DATA (CHART IV)

All data shall be referenced to the relevant serial numbers. Detailed records shall be provided of the components submitted to each test in each of the subgroups and of those rejected.

Detailed data shall be provided of all electrical measurements made in accordance with Tables 2 and 6 of the Detail Specification, as and where applicable.

10.9 LOT ACCEPTANCE TEST DATA (CHART V)

10.9.1 Testing Level 'B'

All data shall be referenced to the relevant serial numbers. Detailed records shall be provided of the components submitted to each test in each of the subgroups (as relevant to the lot acceptance level) and of those rejected.



Detailed data shall be provided of all electrical measurements made in accordance with Table 6 of the Detail Specification, as and where applicable.

10.9.2 Testing Level 'C'

A test result summary (i.e. the total number of components submitted to, and and the total number rejected from, each of the tests and inspections) as relevant to the lot acceptance level shall be provided.

In the case of lot acceptance 2 testing, all data in respect of electrical measurements made in accordance with Table 6 of the Detail Specification shall be referenced to the relevant serial numbers (see Para. 8.2.4(a)).

In the case of lot acceptance 1 testing, all data in respect of electrical measurements made in accordance with Tables 2 and 6 of the Detail Specification shall be referenced to the relevant serial numbers (see Para. 8.2.5(a)).

 	<p style="text-align: center;">ESA/SCC Generic Specification No. 3201</p>	<p style="text-align: center;">Rev. 'A'</p>	<p style="text-align: center;">PAGE 44 ISSUE 3</p>
--	---	---	--

**10.10 FAILED COMPONENTS LIST AND FAILURE ANALYSIS REPORT**

The failed component list and failure analysis report shall provide full details of:-

- (a) The reference number and description of the test or measurement performed as defined in this specification and/or the Detail Specification.
- (b) The serial number or jig position (if applicable) of the failed component.
- (c) The failed parameter and the failure mode of the component.
- (d) Detailed failure analysis, if requested.

**10.11 CERTIFICATE OF CONFORMITY**

A Certificate of Conformity shall be established as defined in ESA/SCC Basic Specification No. 20100.

**11. DELIVERY**

For qualification approval, the disposition of the qualification test lot and its related documentation shall be as specified in ESA/SCC Basic Specification No. 20100 and the relevant paragraphs of Section 10 of this specification.

For procurement, for each order, the items forming the delivery are:-

- (a) The delivery lot.
- (b) The components used for lot acceptance testing, (when applicable), but not forming part of the delivery lot (see Para's 8.2.3(d), 8.2.4(b) and 8.2.5(b)).
- (c) The relevant documentation in accordance with the requirements of Section 10 of this specification.

In the case of a component for which a valid qualification approval is in force, all data of all components submitted to LA1 and LA2 testing shall also be copied, when requested, to the relevant Qualifying Space Agency.

**12. PACKAGING AND DESPATCH**

The packaging and despatch of components to this specification shall be in accordance with the requirements of ESA/SCC Basic Specification No. 20600.



**ANNEXE I**

**LTPD SAMPLING PLAN LOT SIZES GREATER THAN 200 DEVICES**

Minimum size of sample to be tested to assure with a 90% confidence that a lot whose Percent Defective equals the specified LTPD is not accepted (single sample).

Max. Percent Defective (LTPD) or $\lambda$	50	30	20	15	10	7	5	3	2	1.5	1	0.7	0.5	0.3	0.2	0.15	0.1
Acceptance Number (c) ( $r = c + 1$ )	MINIMUM SAMPLE SIZES (FOR DEVICE-HOURS REQUIRED FOR LIFE TEST, MULTIPLY BY 1000)																
0	5 (1.03)	8 (0.64)	11 (0.46)	15 (0.34)	22 (0.23)	32 (0.16)	45 (0.11)	76 (0.07)	116 (0.04)	153 (0.03)	231 (0.02)	328 (0.02)	461 (0.01)	767 (0.007)	1152 (0.005)	1534 (0.003)	2303 (0.002)
1	8 (4.4)	13 (2.7)	18 (2.0)	25 (1.4)	38 (0.94)	55 (0.65)	77 (0.46)	129 (0.28)	195 (0.18)	258 (0.14)	390 (0.09)	555 (0.06)	778 (0.045)	1296 (0.027)	1946 (0.018)	2592 (0.013)	3891 (0.009)
2	11 (7.4)	18 (4.5)	25 (3.4)	34 (2.24)	52 (1.6)	75 (1.1)	105 (0.78)	176 (0.47)	266 (0.31)	354 (0.23)	533 (0.15)	759 (0.11)	1065 (0.080)	1773 (0.045)	2662 (0.031)	3547 (0.022)	5323 (0.015)
3	13 (10.5)	22 (6.2)	32 (4.4)	43 (3.2)	65 (2.1)	94 (1.5)	132 (1.0)	221 (0.62)	333 (0.41)	444 (0.31)	668 (0.20)	953 (0.14)	1337 (0.10)	2226 (0.062)	3341 (0.041)	4452 (0.031)	6681 (0.018)
4	16 (12.3)	27 (7.3)	38 (5.3)	52 (3.9)	78 (2.6)	113 (1.8)	158 (1.3)	265 (0.75)	398 (0.50)	531 (0.37)	798 (0.25)	1140 (0.17)	1599 (0.12)	2663 (0.074)	3997 (0.049)	5327 (0.037)	7994 (0.025)
5	19 (13.8)	31 (8.4)	45 (6.0)	60 (4.4)	91 (2.9)	131 (2.0)	184 (1.4)	308 (0.85)	462 (0.57)	617 (0.42)	927 (0.28)	1323 (0.20)	1855 (0.14)	3090 (0.085)	4638 (0.056)	6181 (0.042)	9275 (0.028)
6	21 (15.6)	35 (9.4)	51 (6.6)	68 (4.9)	104 (3.2)	149 (2.2)	209 (1.6)	349 (0.94)	528 (0.62)	700 (0.47)	1054 (0.31)	1503 (0.22)	2107 (0.155)	3509 (0.093)	5267 (0.062)	7019 (0.047)	10533 (0.031)
7	24 (16.6)	39 (10.2)	57 (7.2)	77 (5.3)	116 (3.5)	166 (2.4)	234 (1.7)	390 (1.0)	589 (0.67)	783 (0.51)	1178 (0.34)	1680 (0.24)	2355 (0.17)	3922 (0.101)	5886 (0.067)	7845 (0.051)	11771 (0.034)
8	26 (18.1)	43 (10.9)	63 (7.7)	85 (5.6)	128 (3.7)	184 (2.6)	258 (1.8)	431 (1.1)	648 (0.72)	864 (0.54)	1300 (0.36)	1854 (0.25)	2599 (0.18)	4329 (0.108)	6498 (0.072)	8660 (0.054)	12995 (0.036)
9	28 (19.4)	47 (11.5)	69 (8.1)	93 (6.0)	140 (3.9)	201 (2.7)	282 (1.9)	471 (1.2)	709 (0.77)	945 (0.58)	1421 (0.38)	2027 (0.27)	2842 (0.19)	4733 (0.114)	7103 (0.077)	9468 (0.057)	14206 (0.038)
10	31 (19.9)	51 (12.1)	75 (8.4)	100 (6.3)	152 (4.1)	218 (2.9)	306 (2.0)	511 (1.2)	770 (0.80)	1025 (0.60)	1541 (0.40)	2199 (0.28)	3082 (0.20)	5133 (0.120)	7704 (0.080)	10268 (0.060)	15407 (0.040)
11	33 (21.0)	54 (12.8)	83 (8.3)	111 (6.2)	166 (4.2)	238 (2.9)	332 (2.1)	555 (1.2)	832 (0.83)	1109 (0.62)	1664 (0.42)	2378 (0.29)	3323 (0.21)	5546 (0.12)	8319 (0.083)	11092 (0.062)	16638 (0.042)
12	36 (21.4)	59 (13.0)	89 (8.6)	119 (6.5)	178 (4.3)	254 (3.0)	356 (2.2)	594 (1.3)	890 (0.86)	1187 (0.65)	1781 (0.43)	2544 (0.3)	3562 (0.22)	5936 (0.13)	8904 (0.086)	11872 (0.065)	17808 (0.043)
13	38 (22.3)	63 (13.4)	95 (8.9)	126 (6.7)	190 (4.5)	271 (3.1)	379 (2.26)	632 (1.3)	948 (0.89)	1264 (0.67)	1896 (0.44)	2709 (0.31)	3793 (0.22)	6321 (0.134)	9482 (0.089)	12643 (0.067)	18964 (0.045)
14	40 (23.1)	67 (13.8)	101 (9.2)	134 (6.9)	201 (4.6)	288 (3.2)	403 (2.3)	672 (1.4)	1007 (0.92)	1343 (0.69)	2015 (0.46)	2878 (0.32)	4029 (0.23)	6716 (0.138)	10073 (0.092)	13431 (0.069)	20146 (0.046)
15	43 (23.3)	71 (14.1)	107 (9.4)	142 (7.1)	213 (4.7)	305 (3.3)	426 (2.36)	711 (1.41)	1066 (0.94)	1422 (0.71)	2133 (0.47)	3046 (0.33)	4265 (0.235)	7108 (0.141)	10662 (0.094)	14216 (0.070)	21324 (0.047)
16	45 (24.1)	74 (14.0)	112 (9.7)	150 (7.2)	225 (4.8)	321 (3.37)	450 (2.41)	750 (1.44)	1124 (0.96)	1499 (0.72)	2249 (0.48)	3212 (0.337)	4497 (0.241)	7496 (0.144)	11244 (0.096)	14992 (0.072)	22487 (0.048)
17	47 (24.7)	79 (14.7)	118 (9.86)	158 (7.36)	236 (4.93)	338 (3.44)	473 (2.46)	788 (1.48)	1182 (0.98)	1576 (0.74)	2364 (0.49)	3377 (0.344)	4728 (0.246)	7880 (0.148)	11819 (0.098)	15759 (0.074)	23639 (0.049)
18	50 (24.9)	83 (15.0)	124 (10.0)	165 (7.54)	248 (5.02)	354 (3.51)	496 (2.51)	826 (1.51)	1239 (1.0)	1652 (0.75)	2478 (0.50)	3540 (0.351)	4956 (0.251)	8260 (0.151)	12390 (0.100)	16520 (0.075)	24780 (0.050)
19	52 (25.5)	86 (15.4)	130 (10.2)	173 (7.76)	259 (5.12)	370 (3.58)	518 (2.56)	864 (1.53)	1296 (1.02)	1728 (0.77)	2591 (0.52)	3702 (0.358)	5183 (0.256)	8638 (0.153)	12957 (0.102)	17276 (0.077)	25914 (0.051)
20	54 (26.1)	90 (15.6)	135 (10.4)	180 (7.82)	271 (5.19)	386 (3.65)	541 (2.60)	902 (1.56)	1353 (1.04)	1803 (0.78)	2705 (0.52)	3864 (0.364)	5410 (0.260)	9017 (0.156)	13526 (0.104)	18034 (0.078)	27051 (0.052)
26	65 (27.0)	109 (16.1)	163 (10.8)	217 (8.08)	326 (5.38)	466 (3.76)	652 (2.69)	1086 (1.61)	1629 (1.08)	2173 (0.807)	3259 (0.538)	4656 (0.376)	6518 (0.269)	10863 (0.161)	16295 (0.108)	21726 (0.081)	32589 (0.054)

- (1) Sample sizes are based upon the Poisson exponential binomial limit.
- (2) The minimum quality (approximate AQL) required to accept (on the average) 19 of 20 lots is shown in parentheses for information only.



**SCC**

ESA/SCC Generic Specification

No. 3201

PAGE 46

ISSUE 3

**ANNEXE I**

Page 2 of 3

**LTPD SAMPLING PLAN LOT SIZES LESS THAN, OR EQUAL TO, 200 DEVICES**

C=0												
N	10	20	30	40	50	60	80	100	120	150	160	200
n	AQL LTPD	AQL LTPD	AQL LTPD	AQL LTPD	AQL LTPD	AQL LTPD	AQL LTPD	AQL LTPD	AQL LTPD	AQL LTPD	AQL LTPD	AQL LTPD
2	2.2 65	2.5 66	2.5 67	2.5 67	2.5 67	2.5 68	2.5 68	2.5 68	2.5 68	2.5 68	2.5 68	2.5 68
4	1.2 36	1.2 40	1.2 42	1.2 42	1.3 42	1.3 43	1.3 43	1.3 43	1.3 43	1.3 43	1.3 44	1.3 44
5	1.0 29	1.0 33	1.0 34	1.0 35	1.0 35	1.0 35	1.0 36	1.0 36	1.0 37	1.0 37	1.0 37	1.0 37
8	0.5 15	0.6 20	0.6 22	0.6 23	0.6 23	0.6 23	0.6 24	0.7 24	0.7 24	0.7 24	0.7 24	0.7 25
10		0.4 15	0.5 17	0.5 19	0.5 19	0.5 19	0.5 20	0.5 20	0.5 20	0.5 20	0.5 20	0.5 20
16		0.2 6.9	0.25 10	0.25 11	0.3 11	0.3 12	0.3 12	0.3 13	0.3 13	0.3 13	0.3 13	0.3 13
20			0.2 6.8	0.2 8.0	0.25 8.7	0.25 9.0	0.25 9.4	0.25 10	0.25 10	0.25 10	0.25 10	0.25 11
25			0.15 4.3	0.15 5.7	0.2 6.4	0.2 6.9	0.2 7.4	0.2 7.5	0.2 7.6	0.2 7.7	0.2 7.8	0.2 7.9
32				0.1 3.7	0.1 4.4	0.1 5.0	0.1 5.5	0.1 5.9	0.15 6.0	0.15 6.2	0.15 6.3	0.15 6.3
40					0.1 3.0	0.1 3.4	0.1 4.0	0.1 4.5	0.1 4.6	0.1 4.9	0.1 5.0	0.15 5.0
50						0.1 2.3	0.1 2.9	0.10 3.3	0.10 3.5	0.10 3.7	0.10 3.7	0.10 3.9
64							0.08 1.7	0.08 2.2	0.08 2.5	0.08 2.7	0.08 2.8	0.08 2.9
80								0.07 1.5	0.07 1.7	0.07 2.0	0.07 2.1	0.07 2.2
100									0.05 1.1	0.05 1.5	0.05 1.5	0.05 1.7
125										0.04 0.8	0.04 0.9	0.04 1.2
128												0.04 1.1
160										0.04 0.8	0.04 0.9	0.03 0.7
C=1												
N	10	20	30	40	50	60	80	100	120	150	160	200
n	AQL LTPD	AQL LTPD	AQL LTPD	AQL LTPD	AQL LTPD	AQL LTPD	AQL LTPD	AQL LTPD	AQL LTPD	AQL LTPD	AQL LTPD	AQL LTPD
2	27 95	24 95	24 95	23 95	23 95	23 95	23 95	23 95	23 95	22 95	22 95	22 95
4	15 62	12 66	12 66	11 67	11 67	10 67	10 67	10 67	10 67	9.8 67	9.7 67	9.7 68
5	13 51	10 55	8.8 56	8.5 57	8.4 57	8.1 58	7.9 58	7.6 58	7.5 58	7.5 58	7.5 58	7.5 58
8	11 28	7.2 35	6.2 38	5.8 38	5.4 39	5.0 39	4.7 39	4.5 39	4.3 39	4.3 40	4.2 40	4.2 40
10		6.2 30	5.0 30	4.6 31	4.2 32	4.2 32	4.2 32	3.9 33	3.5 33	3.3 33	3.3 33	3.3 33
16		5.6 15	4.2 18	3.8 18	3.4 20	3.0 20	2.9 21	2.6 21	2.5 21	2.3 21	2.3 22	2.2 22
20			4.0 13	3.2 15	2.8 16	2.5 16	2.4 16	2.3 16	2.1 17	2.0 17	2.0 17	2.0 18
25			3.8 9.2	3.1 11	2.5 12	2.2 13	2.0 13	1.8 13	1.7 13	1.6 14	1.6 14	1.6 14
32				3.1 7.4	2.4 8.2	2.1 9.0	1.8 9.9	1.6 10	1.5 10.5	1.4 11	1.3 11	1.3 11
40					2.4 5.9	2.1 6.8	1.6 7.6	1.4 7.8	1.3 8.2	1.2 8.3	1.2 8.4	1.2 8.6
50						1.7 4.6	1.4 5.6	1.2 6.1	1.2 6.4	1.0 6.5	0.9 6.7	0.9 6.7
64							1.3 3.8	1.1 4.4	1.0 4.7	0.8 5.0	0.8 5.0	0.7 5.2
80								1.1 3.0	1.0 3.4	0.8 3.7	0.7 3.8	0.6 4.0
100									0.9 2.5	0.7 2.8	0.7 2.8	0.6 3.0
125										0.7 1.9	0.7 2.0	0.5 2.2
128												0.5 2.2
160										0.7 1.7	0.7 1.9	0.5 1.5
C=2												
N	10	20	30	40	50	60	80	100	120	150	160	200
n	AQL LTPD	AQL LTPD	AQL LTPD	AQL LTPD	AQL LTPD	AQL LTPD	AQL LTPD	AQL LTPD	AQL LTPD	AQL LTPD	AQL LTPD	AQL LTPD
4	33 82	28 83	27 84	27 85	27 85	26 85	26 85	26 86	26 86	25 86	25 86	25 86
5	27 69	23 73	21 74	20 74	20 74	20 75	20 75	19 75	19 75	19 75	19 75	19 75
8	22 42	15 49	14 49	13 52	13 52	13 52	12 53	12 53	12 53	11 53	11 53	11 53
10		13 39	11 42	11 42	10 43	10 43	9.6 43	9.2 44	9.1 44	8.9 44	8.9 44	8.7 44
16		11 22	8.6 25	6.9 27	6.8 27	6.4 27	6.0 28	6.0 29	5.9 29	5.9 29	5.7 29	5.5 30
20			7.7 19	6.2 21	5.9 22	5.6 22	5.1 23	4.8 23	4.8 23	4.6 23	4.5 24	4.5 24
25			7.4 13	6.0 16	4.9 17	4.5 17	4.3 18	4.1 18	3.9 18	3.7 18	3.7 19	3.7 19
32				5.5 11	4.8 12	4.3 13	3.6 14	3.4 14	3.2 14	3.0 14.5	3.0 15	2.9 15
40					4.6 8.9	3.9 9.8	3.1 11	2.8 12	2.6 12	2.4 12	2.4 12	2.3 12
50						3.5 6.9	2.8 8.1	2.4 8.4	2.3 8.6	2.1 9.0	2.1 9.3	2.0 9.5
64							2.6 5.7	2.2 6.2	2.0 6.6	1.8 7.1	1.7 7.1	1.6 7.4
80								2.1 4.5	1.8 4.9	1.6 5.4	1.5 5.4	1.4 5.6
100									1.8 3.5	1.4 3.9	1.4 4.0	1.2 4.4
125										1.4 2.8	1.3 2.9	1.1 3.3
128												1.1 3.2
160										1.4 2.6	1.3 2.9	1.1 2.3

**SCC**ESA/SCC Generic Specification  
No. 3201

PAGE 47

ISSUE 3

**ANNEXE I**Page 3 of 3

This table gives the AQL and LTPD values associated with certain single sampling plans (Acceptance Number "C", Sample Size "n" and Lot Size "N"). The table has the following features:-

- (a) Calculations are based upon the hyper-geometric distribution (exact theory) for lot sizes of 200 devices or less.
- (b) The AQL of a sampling plan is defined as the interpolated Percent Defective for which there is a 0.95 probability of acceptance under the plan. The AQL so defined need not be a realisable Lot Percent Defective for the lot size involved (e.g., 12 percent is not a realisable Percent Defective for a lot size of 20 devices).
- (c) The LTPD of a sampling plan is defined as the interpolated Percent Defective for which there is a 0.10 probability of lot acceptance under the plan. The LTPD so defined need not be a realisable Lot Percent Defective for the lot size involved.
- (d) The sequence of sample sizes and lot sizes are generated by taking products of preceding numbers in the respective sequences and the numbers 2 and 5.