



Pages 1 to 17

## **TRANSISTORS, LOW POWER, NPN**

**BASED ON TYPE 2N2222A**

**ESCC Detail Specification No. 5201/002**

Issue 3	December 2008
---------	---------------



Document Custodian: European Space Agency - see <https://escies.org>

**LEGAL DISCLAIMER AND COPYRIGHT**

European Space Agency, Copyright © 2008. All rights reserved.

The European Space Agency disclaims any liability or responsibility, to any person or entity, with respect to any loss or damage caused, or alleged to be caused, directly or indirectly by the use and application of this ESCC publication.

This publication, without the prior permission of the European Space Agency and provided that it is not used for a commercial purpose, may be:

- copied in whole, in any medium, without alteration or modification.
- copied in part, in any medium, provided that the ESCC document identification, comprising the ESCC symbol, document number and document issue, is removed.

**DOCUMENTATION CHANGE NOTICE**

(Refer to <https://escies.org> for ESCC DCR content)

DCR No.	CHANGE DESCRIPTION
421, 447	Specification up issued to incorporate editorial and technical changes per DCR.

**TABLE OF CONTENTS**

<b><u>1.</u></b>	<b><u>GENERAL</u></b>	<b><u>5</u></b>
1.1	Scope	5
1.2	Applicable Documents	5
1.3	Terms, Definitions, Abbreviations, Symbols and Units	5
1.4	The ESCC Component Number and Component Type Variants	5
1.4.1	The ESCC Component Number	5
1.4.2	Component Type Variants	5
1.5	Maximum Ratings	6
1.6	Physical Dimensions and Terminal Identification	7
1.6.1	Metal Can Package (TO-18) - 3 lead	7
1.6.2	Chip Carrier Package (CCP) - 3 terminal	8
1.6.3	Chip Carrier Package (CCP) - 4 terminal	9
1.7	Functional Diagram	9
1.8	Materials and Finishes	10
<b><u>2.</u></b>	<b><u>REQUIREMENTS</u></b>	<b><u>10</u></b>
2.1	General	10
2.1.1	Deviations from the Generic Specification	10
2.2	Marking	10
2.3	Terminal Strength	10
2.4	Electrical Measurements at Room, High and Low Temperatures	11
2.4.1	Room Temperature Electrical Measurements	11
2.4.2	High and Low Temperatures Electrical Measurements	15
2.5	Parameter Drift Values	15
2.6	Intermediate and End-Point Electrical Measurements	15
2.7	Power Burn-in Conditions	16
2.8	Operating Life Conditions	16
APPENDIX 'A'		17

**1. GENERAL**

**1.1 SCOPE**

This specification details the ratings, physical and electrical characteristics and test and inspection data for the component type variants and/or the range of components specified below. It supplements the requirements of, and shall be read in conjunction with, the ESCC Generic Specification listed under Applicable Documents.

**1.2 APPLICABLE DOCUMENTS**

The following documents form part of this specification and shall be read in conjunction with it:

- (a) ESCC Generic Specification No. 5000
- (b) MIL-STD-750, Test Methods and Procedures for Semiconductor Devices

**1.3 TERMS, DEFINITIONS, ABBREVIATIONS, SYMBOLS AND UNITS**

For the purpose of this specification, the terms, definitions, abbreviations, symbols and units specified in ESCC Basic Specification No. 21300 shall apply.

**1.4 THE ESCC COMPONENT NUMBER AND COMPONENT TYPE VARIANTS**

**1.4.1 The ESCC Component Number**

The ESCC Component Number shall be constituted as follows:

Example: 520100201

- Detail Specification Reference: 5201002
- Component Type Variant Number: 01 (as required)

**1.4.2 Component Type Variants**

The component type variants applicable to this specification are as follows:

Variant Number	Based on Type	Case	Lead/Terminal Material and/or Finish	Weight max g	$V_{(BR)CEO}$ min V	$I_{hfe}$
01	2N2222A	TO-18	D2	0.4	40	3 to 10
02	2N2222A	TO-18	D3 or D4	0.4	40	3 to 10
04	2N2222A	CCP (3 Terminal)	2	0.06	40	3 to 10
05	2N2222A	CCP (3 Terminal)	4	0.06	40	3 to 10
06	2N2222A	TO-18	D2	0.4	50	2.5 min
07	2N2222A	TO-18	D3 or D4	0.4	50	2.5 min
09	2N2222A	CCP (3 Terminal)	2	0.06	50	2.5 min
10	2N2222A	CCP (3 Terminal)	4	0.06	50	2.5 min

Variant Number	Based on Type	Case	Lead/Terminal Material and/or Finish	Weight max g	$V_{(BR)CEO}$ min V	$I_{hfe}$
11	2N2222A	CCP (4 Terminal)	2	0.06	40	3 to 10
12	2N2222A	CCP (4 Terminal)	4	0.06	40	3 to 10

The lead/terminal material and/or finish shall be in accordance with the requirements of ESCC Basic Specification No. 23500.

1.5 **MAXIMUM RATINGS**

The maximum ratings shall not be exceeded at any time during use or storage. Maximum ratings shall only be exceeded during testing to the extent specified in this specification and when stipulated in Test Methods and Procedures of the ESCC Generic Specification.

Characteristics	Symbols	Maximum Ratings	Unit	Remarks
Collector-Base Voltage	$V_{CBO}$	75	V	Over entire operating temperature range
Collector-Emitter Voltage	$V_{CEO}$		V	
Variants 01 to 05, 11, 12		40		
Variants 06 to 10		50		
Emitter-Base Voltage	$V_{EBO}$	6	V	
Collector Current	$I_C$	800	mA	Continuous
Power Dissipation For TO-18 and CCP	$P_{tot1}$	0.5	W	At $T_{amb} \leq +25^{\circ}C$ Note 1
For CCP	$P_{tot2}$	0.73 (Note 2)	W	
For TO-18	$P_{tot3}$	1.8	W	At $T_{case} \leq +25^{\circ}C$ Note 1
Operating Temperature Range	$T_{op}$	-65 to +200	$^{\circ}C$	Note 3
Storage Temperature Range	$T_{stg}$	-65 to +200	$^{\circ}C$	Note 3
Soldering Temperature For TO-18	$T_{sol}$	+260	$^{\circ}C$	Note 4 Note 5
For CCP		+245		

**NOTES:**

- For  $T_{amb}$  or  $T_{case} > +25^{\circ}C$ , derate linearly to 0W at +200 $^{\circ}C$ .
- When mounted on a 15 x 15 x 0.6mm ceramic substrate.
- For Variants with tin-lead plating or hot solder dip lead finish all testing performed at  $T_{amb} > +125^{\circ}C$  shall be carried out in a 100% inert atmosphere.
- Duration 10 seconds maximum at a distance of not less than 1.5mm from the device body and the same lead shall not be resoldered until 3 minutes have elapsed.
- Duration 5 seconds maximum and the same terminal shall not be resoldered until 3 minutes have elapsed.

1.6 PHYSICAL DIMENSIONS AND TERMINAL IDENTIFICATION

1.6.1 Metal Can Package (TO-18) - 3 lead

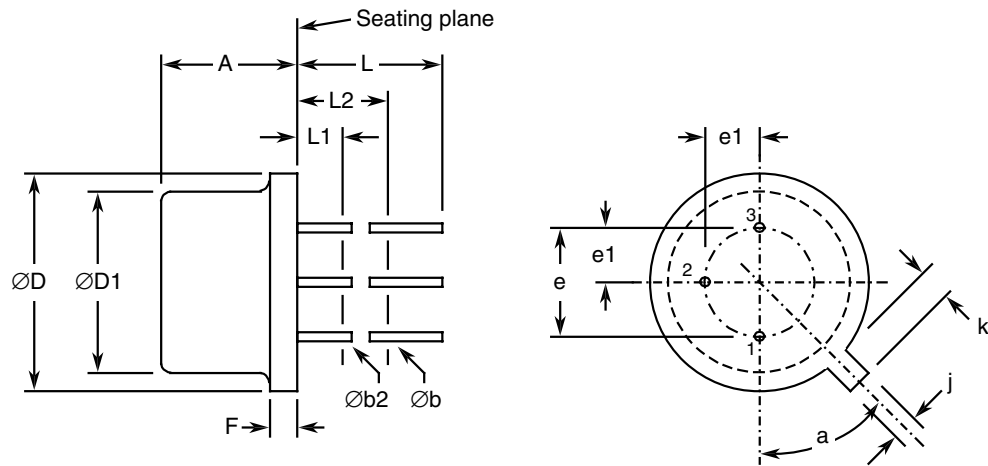

Symbols	Dimensions mm		Notes
	Min	Max	
A	4.32	5.33	
$\varnothing b$	0.406	0.533	2, 3
$\varnothing b2$	0.406	0.483	2, 3
$\varnothing D$	5.31	5.84	
$\varnothing D1$	4.52	4.95	
e	2.54 BSC		4
e1	1.27 BSC		4
F	-	0.762	
j	0.914	1.17	
k	0.711	1.22	5
L	12.7	-	2
L1	-	1.27	3
L2	6.35	-	3
a	45° BSC		1, 4, 6

**NOTES:**

- Terminal identification is specified by reference to the tab position where lead 1 = emitter, lead 2 = base, lead 3 = collector.
- Applies to all leads.
- $\varnothing b2$  applies between  $L1$  and  $L2$ .  $\varnothing b$  applies between  $L2$  and 12.7mm from the seating plane. Diameter is uncontrolled within  $L1$  and beyond 12.7mm from the seating plane.
- Leads having maximum diameter 0.483mm measured in the gauging plane 1.37(+0.025,-0)mm below the seating plane of the device shall be within 0.178mm of their true position relative to a

maximum-width-tab.

5. Measured from the maximum diameter of the actual device.
6. Tab centreline.

1.6.2 Chip Carrier Package (CCP) - 3 terminal

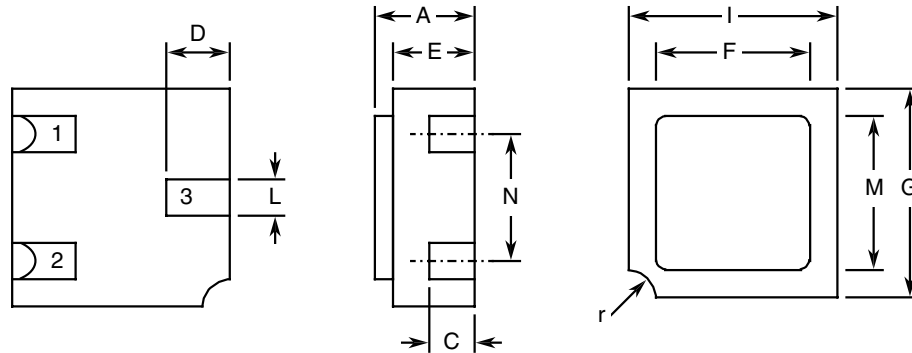

Symbols	Dimensions mm		Notes
	Min	Max	
A	1.15	1.5	
C	0.45	0.56	2
D	0.6	0.91	2
E	0.91	1.12	
F	1.9	2.15	
G	2.9	3.25	
I	2.4	2.85	
L	0.4	0.6	2
M	2.4	2.65	
N	1.8	2	
r	0.3 TYPICAL		1

**NOTES:**

1. Terminal identification is specified by reference to the corner notch position where terminal 1 = emitter, terminal 2= base, terminal 3 = collector.
2. Applies to all terminals.



1.6.3 Chip Carrier Package (CCP) - 4 terminal

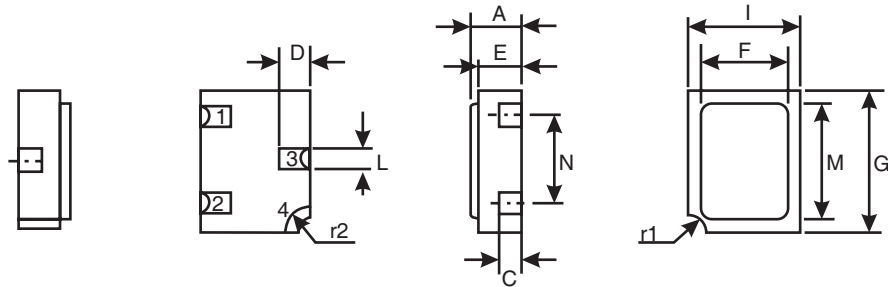

Symbols	Dimensions mm		Notes
	Min	Max	
A	1.15	1.5	
C	0.45	0.56	2
D	0.6	0.91	2
E	0.91	1.12	
F	1.9	2.15	
G	2.9	3.25	
I	2.4	2.85	
L	0.4	0.6	2
M	2.4	2.65	
N	1.8	2	
r1	0.3 TYPICAL		1
r2	0.56 TYPICAL		1

**NOTES:**

- Terminal identification is specified by reference to the corner notch position where terminal 1 = emitter, terminal 2= base, terminal 3 = collector, terminal 4 = shielding connected to the lid.
- Applies to terminals 1, 2, 3.

1.7 FUNCTIONAL DIAGRAM

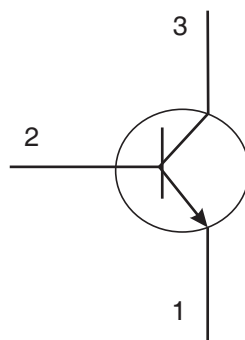

- Emitter.
- Base.
- Collector.
- Shield.

**NOTES:**

1. For TO-18, the collector is internally connected to the case.
2. For 3 terminal CCP (Variants 04, 05, 09, 11) the lid is not connected to any terminal.
3. For 4 terminal CCP (Variants 11, 12) the shielding terminal is connected to the lid.

**1.8 MATERIALS AND FINISHES**

Materials and finishes shall be as follows:

- a) Case  
For the metal can package the case shall be hermetically sealed and have a metal body with hard glass seals.  
For the chip carrier package the case shall be hermetically sealed and have a ceramic body with a Kovar lid.
- b) Leads/Terminals  
As specified in Component Type Variants.

**2. REQUIREMENTS****2.1 GENERAL**

The complete requirements for procurement of the components specified herein are as stated in this specification and the ESCC Generic Specification. Permitted deviations from the Generic Specification, applicable to this specification only, are listed below.

Permitted deviations from the Generic Specification and this Detail Specification, formally agreed with specific Manufacturers on the basis that the alternative requirements are equivalent to the ESCC requirement and do not affect the component's reliability, are listed in the appendices attached to this specification.

**2.1.1 Deviations from the Generic Specification**

- (a) Deviation from Screening Tests - Chart F3  
High Temperature Reverse Bias Burn-in and the subsequent Final Measurements for HTRB shall be omitted.

**2.2 MARKING**

The marking shall be in accordance with the requirements of ESCC Basic Specification No. 21700 and as follows.

The information to be marked on the component shall be:

- (a) The ESCC qualified components symbol (for ESCC qualified components only).
- (b) The ESCC Component Number.
- (c) Traceability information.

**2.3 TERMINAL STRENGTH**

The test conditions for terminal strength, tested as specified in the ESCC Generic Specification, shall be as follows:

For TO-18, Test Condition: E, lead fatigue.

**2.4 ELECTRICAL MEASUREMENTS AT ROOM, HIGH AND LOW TEMPERATURES**

Electrical measurements shall be performed at room, high and low temperatures.

**2.4.1 Room Temperature Electrical Measurements**

 The measurements shall be performed at  $T_{amb}=+22 \pm 3^{\circ}\text{C}$ .

Characteristics	Symbols	MIL-STD-750 Test Method	Test Conditions	Limits		Units
				Min	Max	
Collector-Base Breakdown Voltage	$V_{(BR)CBO}$	3001	$I_C = 100\mu\text{A}$ Bias Condition D	75	-	V
Collector-Emitter Breakdown Voltage Variants 01 to 05, 11, 12 Variants 06 to 10	$V_{(BR)CEO}$	3011	Bias Condition D Note 1  $I_C = 30\text{mA}$  $I_C = 10\text{mA}$	40 50	- -	V
Emitter-Base Breakdown Voltage	$V_{(BR)EBO}$	3026	$I_E = 100\mu\text{A}$ Bias Condition D	6	-	V
Collector-Base Cut-off Current	$I_{CBO}$	3036	$V_{CB} = 60\text{V}$ Bias Condition D	-	10	nA
Emitter-Base Cut-off Current	$I_{EBO}$	3061	$V_{EB} = 3\text{V}$ Bias Condition D	-	10	nA
Collector-Emitter Saturation Voltage	$V_{CE(sat)}$	3071	$I_C=150\text{mA}$ , $I_B=15\text{mA}$ Note 1	-	300	mV
Base-Emitter Saturation Voltage	$V_{BE(sat)}$	3066	$I_C=150\text{mA}$ , $I_B=15\text{mA}$ Note 1	-	1.2	V
Forward-Current Transfer Ratio	$h_{FE1}$	3076	$V_{CE}=10\text{V}$ , $I_C = 100\mu\text{A}$	35	-	-
	$h_{FE2}$		$V_{CE}=10\text{V}$ , $I_C = 10\text{mA}$	75	-	-
	$h_{FE3}$		$V_{CE}=10\text{V}$ , $I_C = 150\text{mA}$ Note 1	100	300	-
	$h_{FE4}$		$V_{CE}=10\text{V}$ , $I_C = 500\text{mA}$ Note 1	40	-	-
Small-Signal Forward-Current Transfer Ratio Variants 01 to 05, 11, 12 Variants 06 to 10	$ h_{fe} $	3306	$V_{CE}=20\text{V}$ , $I_C=20\text{mA}$ $f=100\text{MHz}$ Note 2	3 2.5	10 -	-
Output Capacitance	$C_{obo}$	3236	$V_{CB}=10\text{V}$ , $I_E=0\text{A}$ $100\text{kHz}\leq f\leq 1\text{MHz}$ Note 2	-	8	pF

Characteristics	Symbols	MIL-STD-750 Test Method	Test Conditions	Limits		Units
				Min	Max	
Turn-on Time	$t_{on}$	-	$I_C=150mA$ $I_B=15mA$ Notes 2, 3	-	35	ns
Turn-off Time	$t_{off}$	-	$I_C=150mA$ $I_B=15mA$ Notes 2, 4	-	285	ns

1. Pulse measurement: Pulse Width  $\leq 300\mu s$  (Pulse Width for Variants 06 to 10 of  $V_{(BR)CEO} \leq 15ms$ ), Duty Cycle  $\leq 1\%$
2. For AC characteristics read and record measurements shall be performed on a sample of 32 components with 0 failures allowed. Alternatively a 100% inspection may be performed.
3.  $t_{on}$  shall be measured using the following test circuit. The input waveform shall be supplied by a pulse generator with the following characteristics:  $Z_{OUT} = 50\Omega$ ,  $t_r \leq 2ns$ , Pulse Width =  $200 \pm 10ns$ , Duty Cycle  $\leq 2\%$ . The input and output waveforms shall be monitored on an oscilloscope with the following:  $Z_{IN} \geq 100k\Omega$ , input capacitance  $\leq 12pF$ ,  $t_r \leq 5ns$ .

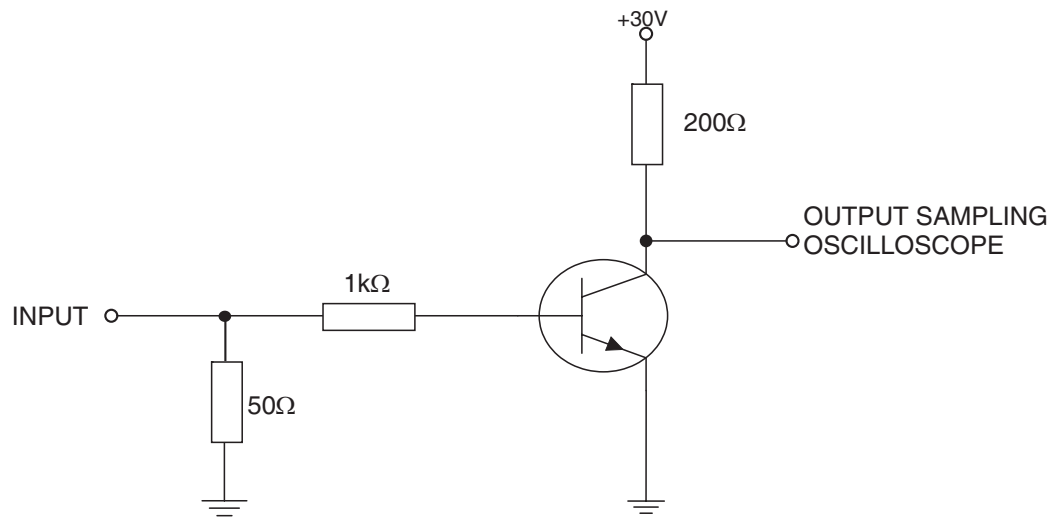

**VOLTAGE WAVEFORMS**

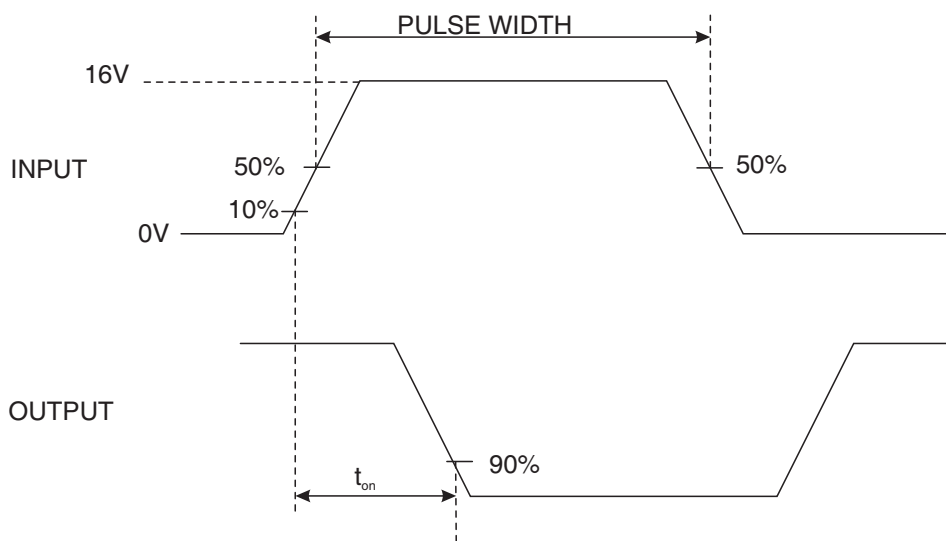

4.  $t_{off}$  shall be measured using the following test circuit. The input waveform shall be supplied by a pulse generator with the following characteristics:  $Z_{OUT} = 50\Omega$ ,  $t_r \leq 2ns$ , Pulse Width = 10 to 100 $\mu s$ , Duty Cycle  $\leq 2\%$ . The input and output waveforms shall be monitored on an oscilloscope with the following characteristics:  $Z_{IN} \geq 100k\Omega$ , input capacitance  $\leq 12pF$ ,  $t_r \leq 5ns$ .

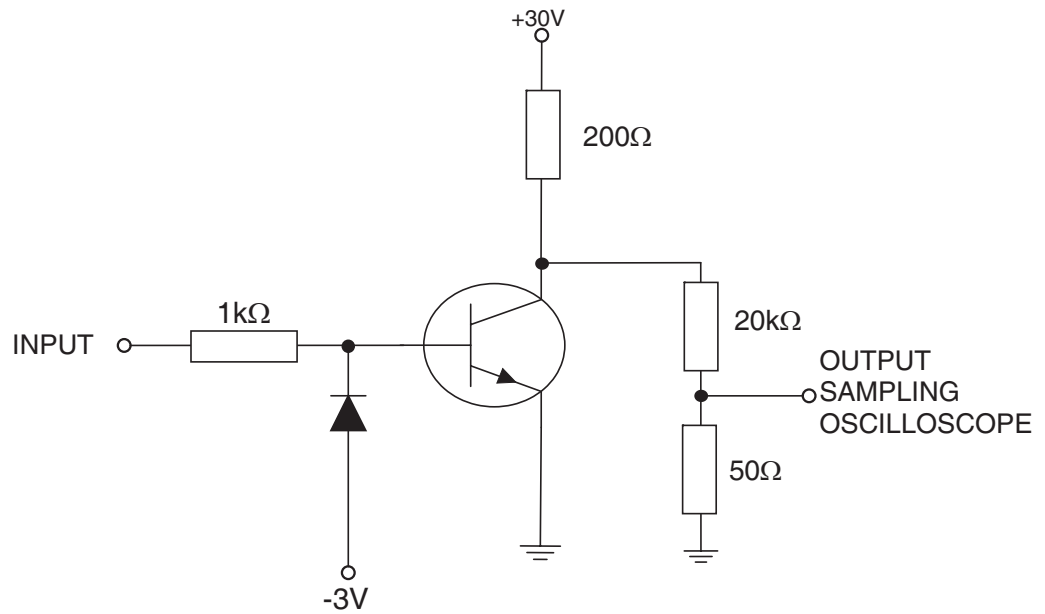

Diode is 1N916 or equivalent

**VOLTAGE WAVEFORMS**

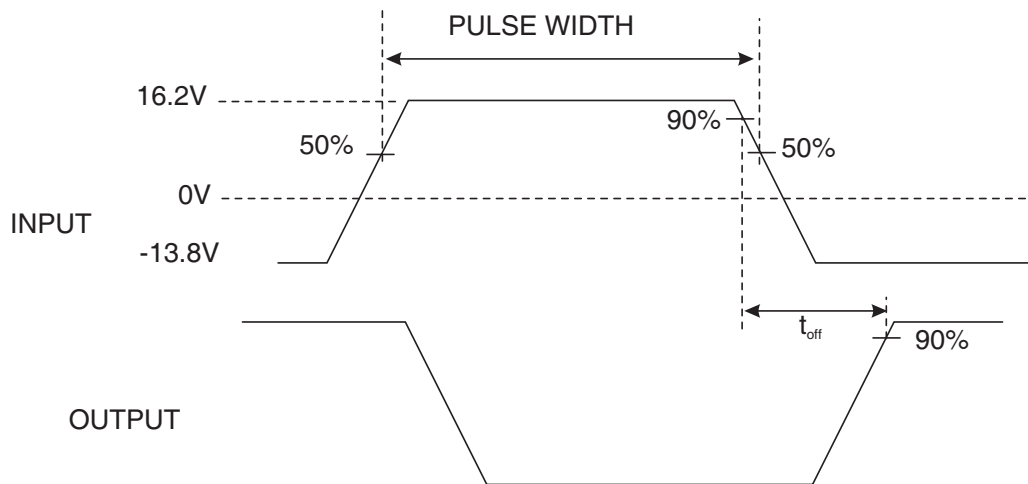

2.4.2 High and Low Temperatures Electrical Measurements

Characteristics	Symbols	MIL-STD-750 Test Method	Test Conditions Note 1	Limits		Units
				Min	Max	
Collector-Base Cut-off Current	$I_{CBO}$	3036	$T_{amb}=+150(+0-5)^{\circ}C$ $V_{CB}=60V$ , Bias Condition D	-	10	$\mu A$
Forward-Current Transfer Ratio 2	$h_{FE2}$	3076	$T_{amb}=-55(+5-0)^{\circ}C$ $V_{CE}=10V$ $I_C=10mA$	35	-	-

1. Read and record measurements shall be performed on a sample of 5 components with 0 failures allowed. Alternatively a 100% inspection may be performed.

2.5 PARAMETER DRIFT VALUES

Unless otherwise specified, the measurements shall be performed at  $T_{amb}=+22 \pm 3^{\circ}C$ . The test methods and test conditions shall be as per the corresponding test defined in Room Temperature Electrical Measurements. The drift values ( $\Delta$ ) shall not be exceeded for each characteristic specified. The corresponding absolute limit values for each characteristic shall not be exceeded.

Characteristics	Symbols	Limits			Units
		Drift Value $\Delta$	Absolute		
			Min	Max	
Collector-Base Cut-off Current	$I_{CBO}$	$\pm 5$ or (1) $\pm 100\%$	-	10	nA
Collector-Emitter Saturation Voltage	$V_{CE(sat)}$	$\pm 30$ or (1) $\pm 15\%$	-	300	mV
Forward-Current Transfer Ratio 3	$h_{FE3}$	$\pm 15\%$	100	300	-

**NOTES:**

1. Whichever is the greater referred to the initial value.

2.6 INTERMEDIATE AND END-POINT ELECTRICAL MEASUREMENTS

Unless otherwise specified, the measurements shall be performed at  $T_{amb}=+22 \pm 3^{\circ}C$ . The test methods and test conditions shall be as per the corresponding test defined in Room Temperature Electrical Measurements . The limit values for each characteristic shall not be exceeded.

Characteristics	Symbols	Limits		Units
		Min	Max	
Collector-Base Cut-off Current	$I_{CBO}$	-	10	nA
Collector-Emitter Saturation Voltage	$V_{CE(sat)}$	-	300	mV
Forward-Current Transfer Ratio 3	$h_{FE3}$	100	300	-

2.7 POWER BURN-IN CONDITIONS

Characteristics	Symbols	Test Conditions	Units
Ambient Temperature	$T_{amb}$	+20 to +50	°C
Power Dissipation	$P_{tot}$	As per Maximum Ratings $P_{tot1}$ derated at the chosen $T_{amb}$	W
Collector-Base Voltage	$V_{CB}$	10 to 40	V

2.8 OPERATING LIFE CONDITIONS

The conditions shall be as specified for Power Burn-in.



**APPENDIX 'A'**

**AGREED DEVIATIONS FOR STMICROELECTRONICS (F)**

ITEMS AFFECTED	DESCRIPTION OF DEVIATIONS
Deviations from Production Control-Chart F2	<p>Special In-process Control Internal Visual Inspection.            For CCP packages the criteria specified for voids in the fillet and minimum die mounting material around the visible die perimeter for die mounting defects may be omitted providing that a radiographic inspection to verify the die-attach process is performed on a sample basis in accordance with STMicronics procedure 0076637.</p>
Deviations from Room Temperature Electrical Measurements	<p>All AC characteristics (Room Temperature Electrical Measurement Note 2) may be considered guaranteed but not tested if successful pilot lot testing has been performed on the wafer lot which includes AC characteristic measurements per the Detail Specification.</p> <p>A summary of the pilot lot testing shall be provided if required by the Purchase Order.</p>
Deviations from High and Low Temperatures Electrical Measurements	<p>All characteristics specified may be considered guaranteed but not tested if successful pilot lot testing has been performed on the wafer lot which includes characteristic measurements at high and low temperatures per the Detail Specification. A summary of the pilot lot testing shall be provided if required by the Purchase Order.</p>
Deviations from Screening Tests - Chart F3	<p>Solderability is not applicable unless specifically stipulated in the Purchase Order.</p>