



Pages 1 to 22

**CONNECTORS, ELECTRICAL, CIRCULAR,  
TRIPLE-START SELF-LOCKING COUPLING,  
SCOOP-PROOF, REMOVEABLE CRIMP CONTACTS**

**BASED ON MIL-C-38999 SERIES III**

**ESCC Detail Specification No. 3401/056**

**ISSUE 2**

**May 2004**



Document Custodian: European Space Agency - see <https://escies.org>

	ESCC Detail Specification No. 3401/056		PAGE i ISSUE 2
---	---	--	-------------------

### LEGAL DISCLAIMER AND COPYRIGHT

European Space Agency, Copyright © 2004. All rights reserved.

The European Space Agency disclaims any liability or responsibility, to any person or entity, with respect to any loss or damage caused, or alleged to be caused, directly or indirectly by the use and application of this ESCC publication.

This publication, without the prior permission of the European Space Agency and provided that it is not used for a commercial purpose, may be:

- copied in whole in any medium without alteration or modification.
- copied in part, in any medium, provided that the ESCC document identification, comprising the ESCC symbol, document number and document issue, is removed.

	<p>ESCC Detail Specification No. 3401/056</p>		<p>PAGE 2 ISSUE 2</p>
---	---	--	---------------------------

**DOCUMENTATION CHANGE NOTICE**

(Refer to <https://escies.org> for ESCC DCR content)

DCR No.	CHANGE DESCRIPTION
108	Specification upissued to incorporate editorial and technical changes per DCR.



**TABLE OF CONTENTS**

	<u>Page</u>
<b>1. <u>GENERAL</u></b>	<b>5</b>
1.1 Scope	5
1.2 Range of Components	5
1.3 Maximum Ratings	5
1.4 Parameter Derating Information	5
1.5 Physical Dimensions	5
<b>2. <u>APPLICABLE DOCUMENTS</u></b>	<b>5</b>
<b>3. <u>TERMS, DEFINITIONS, ABBREVIATIONS, SYMBOLS AND UNITS</u></b>	<b>5</b>
<b>4. <u>REQUIREMENTS</u></b>	<b>14</b>
4.1 General	14
4.2 Deviations from Generic Specification	14
4.2.1 Deviations from Special In-process Controls	14
4.2.2 Deviations from Final Production Tests	14
4.2.3 Deviations from Burn-in and Electrical Measurements	14
4.2.4 Deviations from Qualification Tests	14
4.2.5 Deviations from Lot Acceptance Tests	14
4.3 Mechanical Requirements	14
4.3.1 Dimension Check	14
4.3.2 Weight	15
4.3.3 Contact Capability	15
4.3.4 Contact Retention	15
4.3.5 Mating and Unmating Forces	15
4.3.6 Insert Retention	15
4.3.7 Jackscrew Retention	15
4.3.8 Contact Insertion and Withdrawal Forces	15
4.3.9 Engagement and Separation Forces	15
4.3.10 Oversize Pin Exclusion	15
4.3.11 Probe Damage	15
4.3.12 Solderability	15
4.4 Materials and Finishes	15
4.4.1 Shell, Coupling Ring and Nuts	15
4.4.2 Inserts	15
4.4.3 Contacts	15
4.4.4 Contact Retaining Clip	15
4.4.5 Guiding and Locking Devices	16
4.4.6 Magnetism Level	16
4.5 Marking	16
4.5.1 General	16
4.5.2 Contact Identification	16
4.5.3 The ESCC Component Number	16
4.5.4 Characteristics	16
4.5.5 Traceability Information	18
4.5.6 Marking of Small Components	18
4.6 Electrical Measurements	18
4.6.1 Electrical Measurements at Room Temperature	18
4.6.2 Electrical Measurements at High and Low Temperatures	18
4.6.3 Circuit for Electrical Measurements	18
4.7 Burn-in and Electrical Measurements	18
4.8 Environmental and Endurance Tests	19
4.8.1 Measurements and Inspections on Completion of Environmental Tests	19
4.8.2 Measurements and Inspections at Intermediate Points during Endurance Tests	19
4.8.3 Measurements and Inspections on Completion of Endurance Tests	19
4.8.4 Conditions for Operating Life Test	19



4.8.5	Electrical Circuits for Operating Life Test	<u>Page</u> 19
4.8.6	Conditions for High Temperature Storage Test	19

**TABLES**

1(a)	Range of Components	6
1(b)	Maximum Ratings	6
2	Electrical Measurements at Room Temperature	19
3	Not applicable	N/A
4	Not applicable	N/A
5	Not applicable	N/A
6	Measurements and Inspections on Completion of Environmental and Endurance Tests	20

**FIGURES**

1	Parameter Derating Information	7
2	Physical Dimensions	8
2(a)	Physical Dimensions - Receptables and Plugs	8
2(b)	Physical Dimensions - Contact Arrangements	10
2(c)	Physical Dimensions - Clocking Positions	13

**APPENDICES (Applicable to specific Manufacturers only)**

None.



1. **GENERAL**

1.1 **SCOPE**

This specification details the ratings, physical and electrical characteristics, test and inspection data for Connectors, Electrical, Circular, Triple-Start Self-Locking Coupling, Scoop-proof, Crimp Removable Contacts, based on MIL-C-38999 Series III.

It shall be read in conjunction with:

- ESCC Generic Specification No. 3401, Connectors, Electrical, Non-Filtered, Circular and Rectangular.
- ESCC Detail Specification No. 3401/058, Contacts, Electrical, Crimp, for 3401/052 and /056 Connectors.
- ESCC Detail Specification No. 3401/062, Accessories for Circular Connectors 3401/044, 3401/052 and 3401/056.
- ESCC Detail Specification No. 3401/066, Contacts, Electrical, Triax, Crimp for 3401/056 Connectors.

the requirements of which are supplemented herein.

1.2 **RANGE OF COMPONENTS**

The different sizes of connectors specified herein, which are also covered by this specification, together with their mechanical characteristics, are given in Table 1(a).

1.3 **MAXIMUM RATINGS**

The maximum ratings, which shall not be exceeded at any time during use or storage, applicable to the connectors specified herein, are scheduled in Table 1(b).

1.4 **PARAMETER DERATING INFORMATION**

The applicable derating information for the connectors specified herein is shown in Figure 1.

1.5 **PHYSICAL DIMENSIONS**

The physical dimensions of the connectors specified herein are shown in Figure 2.

2. **APPLICABLE DOCUMENTS**

The following documents form part of this specification and shall be read in conjunction with it:-

- (a) ESCC Generic Specification No. 3401, Connectors, Electrical, Non-Filtered, Circular and Rectangular.
- (b) ESCC Detail Specification No. 3401/058, Contacts, Electrical, Crimp, for 3401/052 and /056 Connectors.
- (c) ESCC Detail Specification No. 3401/062, Accessories for Circular Connectors 3401/044, 3401/052 and 3401/056.
- (d) ESCC Detail Specification No. 3401/066, Contacts, Electrical, Triax, Crimp for 3401/056 Connectors.
- (e) MIL-STD-1560, Insert Arrangements for MIL-C-38999 and MIL-C-27599 Electrical Circular Connectors.
- (f) MIL-STD-1344, Test Methods for Electrical Connectors.

3. **TERMS, DEFINITIONS, ABBREVIATIONS, SYMBOLS AND UNITS**

For the purpose of this specification, the terms, definitions, abbreviations, symbols and units specified in ESCC Basic Specification No. 21300 shall apply.



**TABLE 1(a) - RANGE OF COMPONENTS**

SHELL STYLE	SHELL SIZE	MAX. WEIGHT (g) (1)		MATING & UNMATING AXIAL FORCE (N)		MATING TORQUE MAX (Nm)	UNMATING TORQUE		TIGHT. TORQUE FOR MTG NUT SHELL 07 MAX (Nm)
		SHELL TYPE		MIN	MAX		MAX (Nm)	MIN (Nm)	
		00	07						
Receptacle	09	11	15	-	-	-	-	-	6.0
Receptacle	11	17	20	-	-	-	-	-	8.0
Receptacle	13	22	26	-	-	-	-	-	10
Receptacle	15	25	34	-	-	-	-	-	13
Receptacle	17	38	44	-	-	-	-	-	16
Receptacle	19	40	49	-	-	-	-	-	18
Receptacle	21	52	60	-	-	-	-	-	20
Receptacle	23	54	63	-	-	-	-	-	22
Receptacle	25	58	75	-	-	-	-	-	24
		SHELL TYPES 06 & 66							
Plug	09	17		2.0	111	0.9	0.9	0.2	-
Plug	11	23		2.0	111	1.4	1.4	0.2	-
Plug	13	28		2.0	133	1.8	1.8	0.2	-
Plug	15	34		2.0	133	2.3	2.3	0.3	-
Plug	17	44		2.0	156	2.7	2.7	0.3	-
Plug	19	49		2.0	156	3.2	3.2	0.3	-
Plug	21	60		2.0	156	3.6	3.6	0.6	-
Plug	23	63		2.0	156	4.1	4.1	0.6	-
Plug	25	70		2.0	156	4.6	4.6	0.6	-

**NOTES**

- Without contacts. See ESCC Detail Specifications No. 3401/058 and 3401/066 for contact weights.

**TABLE 1(b) - MAXIMUM RATINGS**

NO	CHARACTERISTICS	SYMBOL	MAXIMUM RATING	UNIT
1	Working Voltage (Sea Level) (1) Service rating N Service rating M Service rating I Service rating II	$U_R$	250 325 450 575	Vrms
2	Operating Temperature Range	$T_{op}$	- 65 to + 200	°C
3	Storage Temperature Range	$T_{stg}$	- 65 to + 200	°C
4	Tightening Torque for Mounting Nut Shell 07	$T_q$	See Table 1(a)	

**NOTES**

- See Para. 4.5.4.2.

**FIGURE 1 - PARAMETER DERATING INFORMATION**

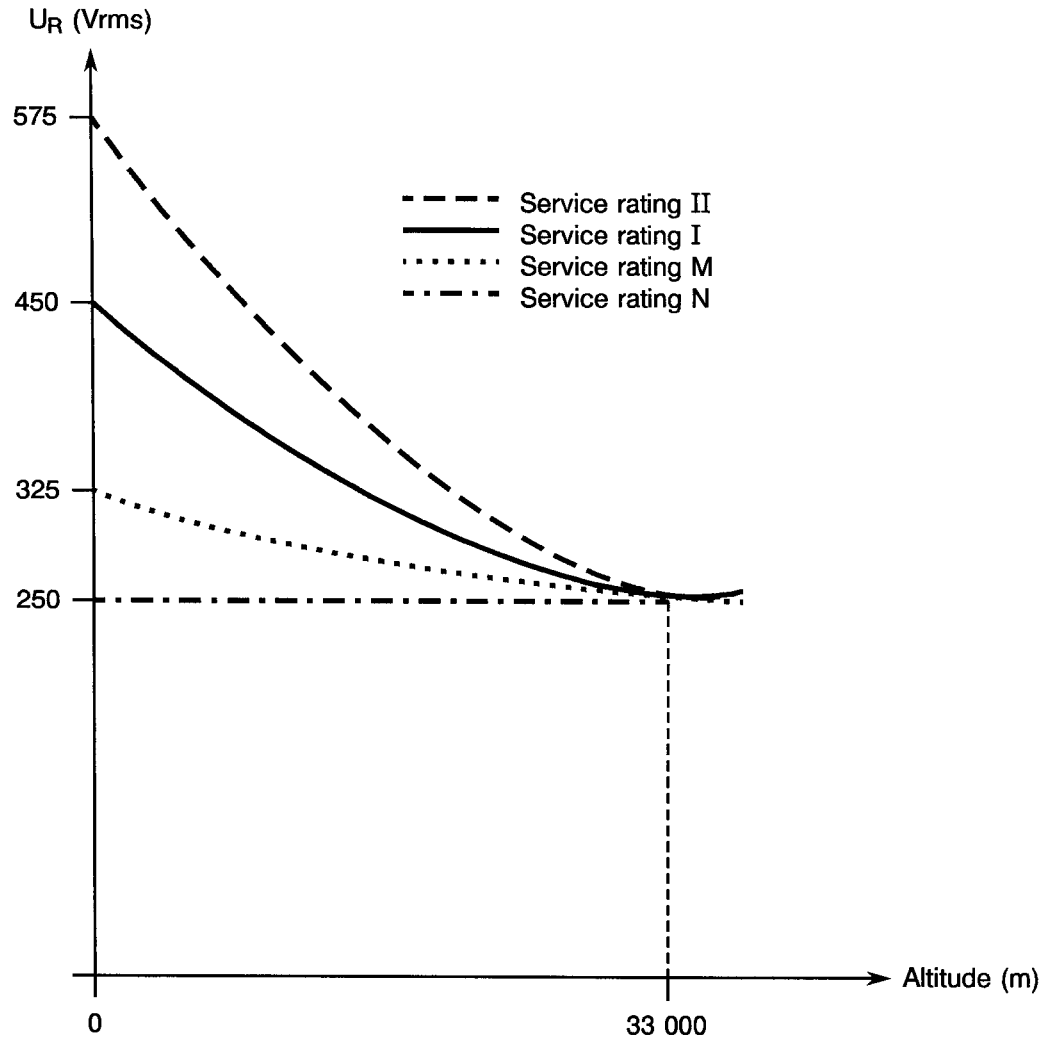

Working Voltage versus Altitude



**FIGURE 2 - PHYSICAL DIMENSIONS**

**FIGURE 2(a) - RECEPTACLES AND PLUGS**

Shell type 00: Square flange receptacle

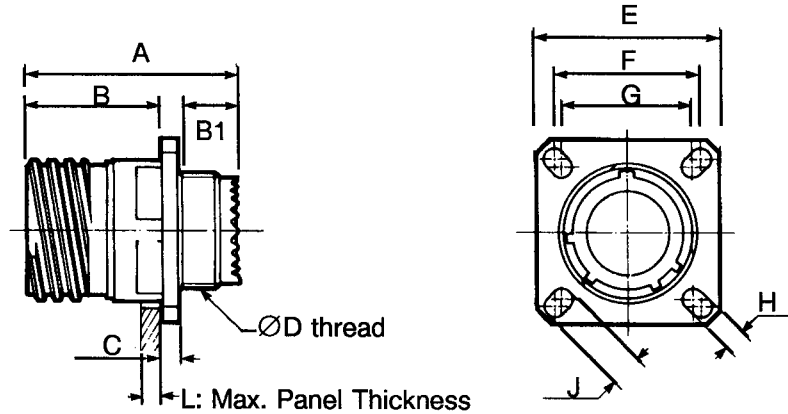

SHELL SIZE	09		11		13		15		17		19		21		23		25	
	MIN	MAX	MIN	MAX	MIN	MAX	MIN	MAX	MIN	MAX	MIN	MAX	MIN	MAX	MIN	MAX	MIN	MAX
A	-	31.50	-	31.50	-	31.50	-	31.50	-	31.50	-	31.50	-	31.50	-	31.50	-	31.50
B1	7.12	-	7.12	-	7.12	-	7.12	-	7.12	-	7.12	-	7.12	-	7.12	-	7.12	-
B	-	20.90	-	20.90	-	20.90	-	20.90	-	20.90	-	20.90	-	20.10	-	20.10	-	20.10
C	-	2.50	-	2.50	-	2.50	-	2.50	-	2.50	-	2.50	-	3.20	-	3.20	-	3.20
ØD	M 12 x 1-6g		M 15 x 1-6g		M 18 x 1-6g		M 22 x 1-6g		M 25 x 1-6g		M 28 x 1-6g		M 31 x 1-6g		M 34 x 1-6g		M 37 x 1-6g	
E	23.50	24.10	25.90	26.50	28.30	28.90	30.70	31.30	33.00	33.60	36.20	36.80	39.40	40.00	42.60	43.20	45.70	46.30
F	18.16	18.36	20.52	20.72	22.91	23.11	24.51	24.71	26.87	27.07	29.26	29.46	31.65	31.85	34.83	35.03	38.00	38.20
G	14.99	15.19	18.16	18.36	20.52	20.72	22.91	23.11	24.51	24.71	26.87	27.07	29.26	29.46	31.65	31.85	34.83	35.03
H	3.05	3.45	3.05	3.45	3.05	3.45	3.05	3.45	3.05	3.45	3.05	3.45	3.05	3.45	3.71	4.11	3.71	4.11
J	5.29	5.69	4.73	5.13	4.73	5.13	4.19	4.59	4.73	5.13	4.73	5.13	4.73	5.13	5.95	6.35	5.95	6.35
L	-	2.50	-	2.50	-	2.50	-	2.50	-	2.50	-	2.50	-	2.50	-	2.50	-	2.50

**NOTES**

1. All dimensions are in millimetres.

**FIGURE 2 - PHYSICAL DIMENSIONS (CONTINUED)**

**FIGURE 2(a) - RECEPTACLES AND PLUGS**

Shell types 06 & 66: Plug

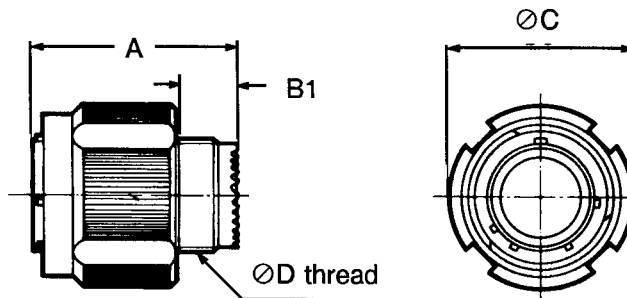

SHELL SIZE	09		11		13		15		17		19		21		23		25	
	MIN	MAX	MIN	MAX	MIN	MAX	MIN	MAX	MIN	MAX	MIN	MAX	MIN	MAX	MIN	MAX	MIN	MAX
A	-	31.00	-	31.00	-	31.00	-	31.00	-	31.00	-	31.00	-	31.00	-	31.00	-	31.00
B1	7.12	-	7.12	-	7.12	-	7.12	-	7.12	-	7.12	-	7.12	-	7.12	-	7.12	-
ØC	-	21.80	-	25.00	-	29.40	-	32.50	-	35.70	-	38.50	-	41.70	-	44.85	-	48.00
ØD	M 12 x 1-6g		M 15 x 1-6g		M 18 x 1-6g		M 22 x 1-6g		M 25 x 1-6g		M 28 x 1-6g		M 31 x 1-6g		M 34 x 1-6g		M 37 x 1-6g	

Shell type 07: Single hole mounting receptacle

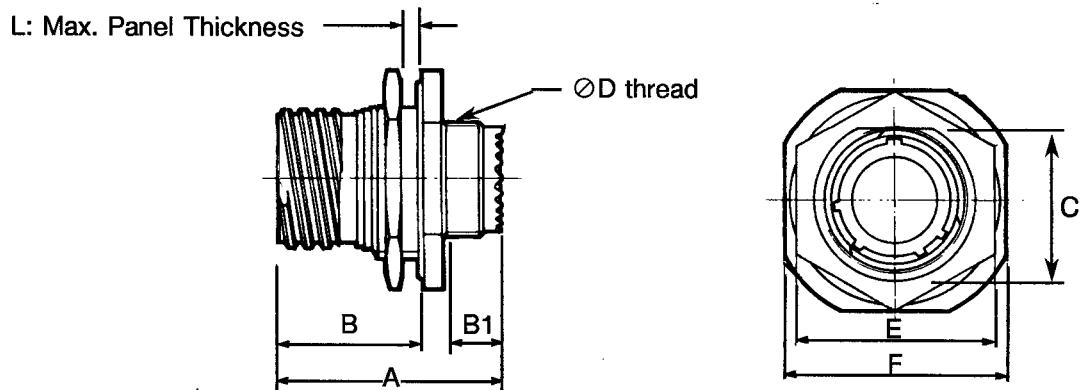

SHELL SIZE	09		11		13		15		17		19		21		23		25	
	MIN	MAX	MIN	MAX	MIN	MAX	MIN	MAX	MIN	MAX	MIN	MAX	MIN	MAX	MIN	MAX	MIN	MAX
A	-	32.50	-	32.50	-	32.50	-	32.50	-	32.50	-	32.50	-	32.50	-	32.50	-	32.50
B1	7.12	-	7.12	-	7.12	-	7.12	-	7.12	-	7.12	-	7.12	-	7.12	-	7.12	-
B	-	22.60	-	22.60	-	22.60	-	22.60	-	22.60	-	22.60	-	22.60	-	22.60	-	22.60
C	16.38	16.63	18.92	19.17	23.67	23.92	26.82	27.07	30.00	30.25	33.17	33.42	36.35	36.60	39.52	39.77	42.70	42.95
ØD	M 12 x 1-6g		M 15 x 1-6g		M 18 x 1-6g		M 22 x 1-6g		M 25 x 1-6g		M 28 x 1-6g		M 31 x 1-6g		M 34 x 1-6g		M 37 x 1-6g	
E	-	24.00	-	27.00	-	32.00	-	36.00	-	37.00	-	41.00	-	46.00	-	50.00	-	51.23
F	26.60	27.40	31.40	32.20	34.50	35.30	37.70	38.50	40.90	41.70	45.60	46.40	48.80	49.60	52.00	52.80	55.20	56.00
L	-	3.20	-	3.20	-	3.20	-	3.20	-	3.20	-	3.20	-	3.20	-	3.20	-	3.20

**NOTES**

1. All dimensions are in millimetres.

**FIGURE 2 - PHYSICAL DIMENSIONS (CONTINUED)**

**FIGURE 2(b) - HIGH DENSITY CONTACT ARRANGEMENTS - FRONT VIEW MALE INSERT**

09-35



6 # 22D

11-35



13 # 22D

13-35

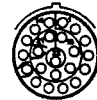

22 # 22D

15-35

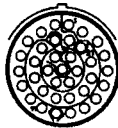

37 # 22D

17-35

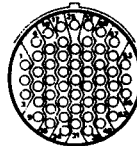

55 # 22D

19-35

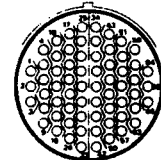

66 # 22D

21-35

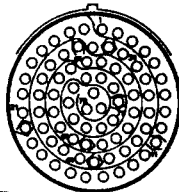

79 # 22D

23-35

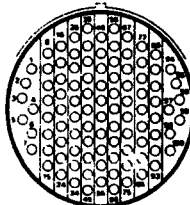

100 # 22D

25-35

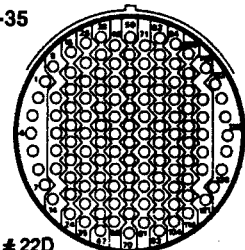

128 # 22D

**NOTES**

1. Contact locations and identifications in conformity with MIL-STD-1560.
2. Both sides of the inserts shall be marked.

**FIGURE 2 - PHYSICAL DIMENSIONS (CONTINUED)**

**FIGURE 2(b) - STANDARD CONTACT ARRANGEMENTS - FRONT VIEW MALE INSERT**

**09-98**



3 # 20

**11-98**



6 # 20

**13-98**



10 # 20

**15-19**

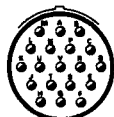

19 # 20

**17-26**

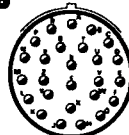

26 # 20

**19-32**

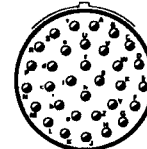

32 # 20

**21-41**

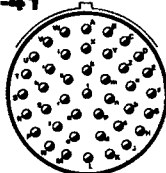

41 # 20

**23-53**

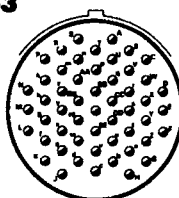

53 # 20

**25-61**

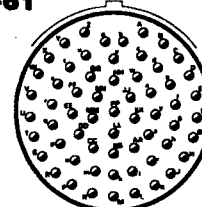

61 # 20

**NOTES**

1. Contact locations and identifications in conformity with MIL-STD-1560.
2. Both sides of the inserts shall be marked.

**FIGURE 2 - PHYSICAL DIMENSIONS (CONTINUED)**

**FIGURE 2(b) - SPECIAL CONTACT ARRANGEMENTS -FRONT VIEW MALE INSERT**

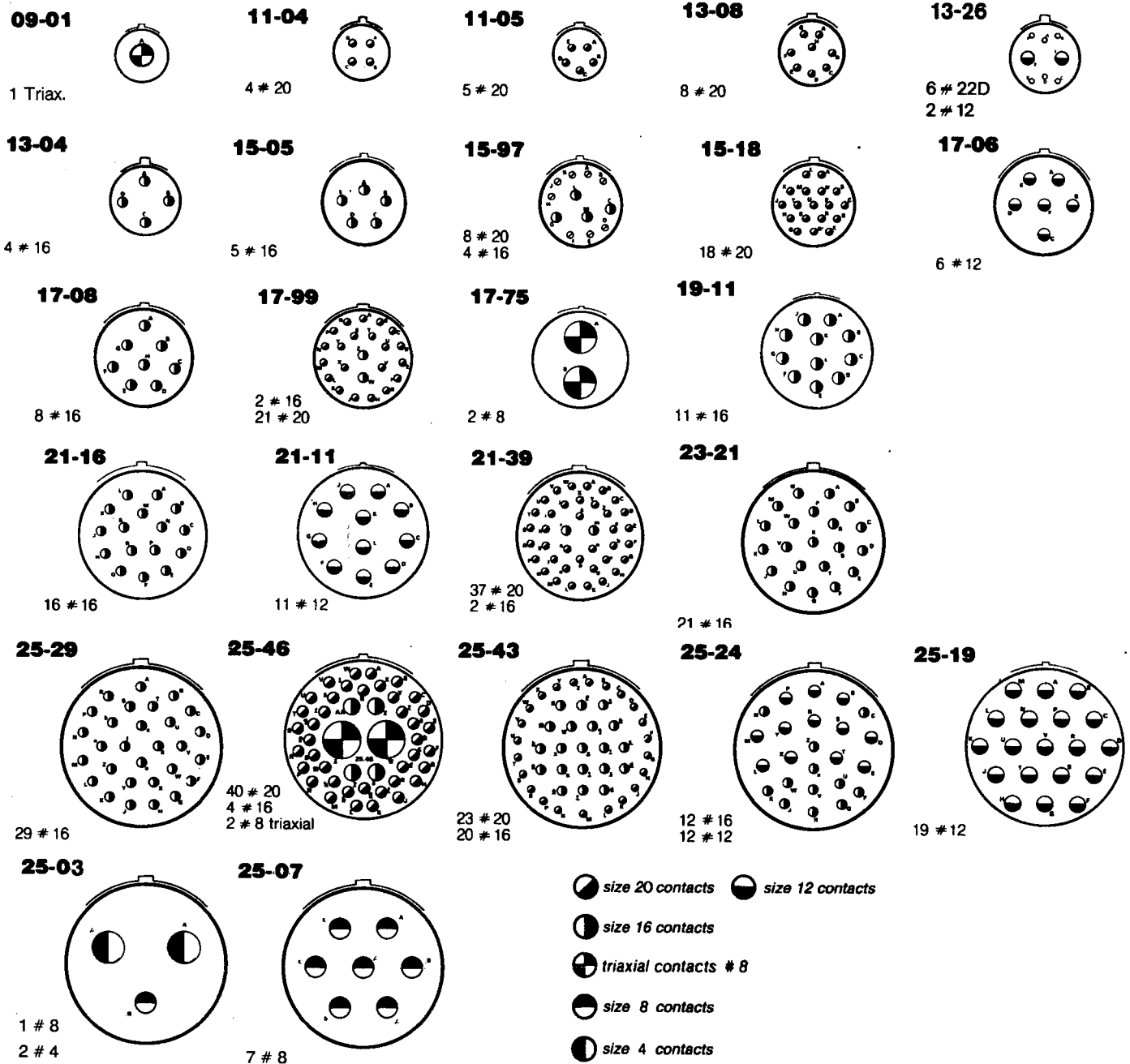

**NOTES**

- Contact locations and identifications in conformity with MIL-STD-1560.
- Both sides of the inserts shall be marked.
- For the 09-01 arrangement, the use of the backshell in ESCC Detail Specification No. 3401/062 is mandatory.

**FIGURE 2- PHYSICAL DIMENSIONS (CONTINUED)**

**FIGURE 2(c) - CLOCKING POSITIONS**

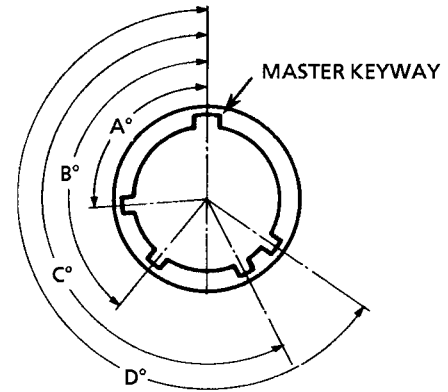

**NOTES**

1. The clocking position is determined by the different angles of the secondary keyways, the insert being always in the same position with respect to the master keyway position which is fixed.

Receptacle front end view

SHELL SIZE	ANGLES	CLOCKING POSITIONS					
		N	A	B	C	D	E
09	A°	105	102	80	35	64	91
	B°	140	132	118	140	155	131
	C°	215	248	230	205	234	197
	D°	265	320	312	275	304	240
11	A°	95	113	90	53	119	51
	B°	141	156	145	156	146	141
	C°	208	182	195	220	176	184
	D°	236	292	252	255	298	242
13	A°	95	113	90	53	119	51
	B°	141	156	145	156	146	141
	C°	208	182	195	220	176	184
	D°	236	292	252	255	298	242
15	A°	95	113	90	53	119	51
	B°	141	156	145	156	146	141
	C°	208	182	195	220	176	184
	D°	236	292	252	255	298	242
17	A°	80	135	49	66	62	79
	B°	142	170	169	140	145	153
	C°	196	200	200	200	180	197
	D°	293	310	244	257	280	272
19	A°	80	135	49	66	62	79
	B°	142	170	169	140	145	153
	C°	196	200	200	200	180	197
	D°	293	310	244	257	280	272
21	A°	80	135	49	66	62	79
	B°	142	170	169	140	145	153
	C°	196	200	200	200	180	197
	D°	293	310	244	257	280	272
23	A°	80	135	49	66	62	79
	B°	142	170	169	140	145	153
	C°	196	200	200	200	180	197
	D°	293	310	244	257	280	272
25	A°	80	135	49	66	62	79
	B°	142	170	169	140	145	153
	C°	196	200	200	200	180	197
	D°	293	310	244	257	280	272

	<p style="text-align: center;">ESCC Detail Specification No. 3401/056</p>	<p style="text-align: right;">PAGE 14 ISSUE 3</p>
--	---	---

#### 4. REQUIREMENTS

##### 4.1 GENERAL

The complete requirements for procurement of the connectors specified herein are stated in this specification and ESCC Generic Specification No. 3401. Deviations from the Generic Specification applicable to this specification only, are listed in Para 4.2.

Deviations from the applicable Generic Specification and this Detail Specification, formally agreed with specific Manufacturers on the basis that the alternative requirements are equivalent to the ESCC requirements and do not affect the components' reliability, are listed in the Appendices attached to this specification.

##### 4.2 DEVIATIONS FROM GENERIC SPECIFICATION

###### 4.2.1 Deviations from Special In-process Controls

None.

###### 4.2.2 Deviations from Final Production Tests (Chart II)

(a) Para 9.5, Magnetism Level: Not applicable. Instead, a magnetic permeability test shall be performed in accordance with Method 3006 of MIL-STD-1344. The magnetic permeability of assembled connectors (with contacts and accessories as applicable) shall not exceed 2Mu. The test shall be performed on 1 sample per shell size.

###### 4.2.3 Deviations from Burn-in and Electrical Measurements (Chart III)

Not applicable.

###### 4.2.4 Deviations from Qualification Tests (Chart IV)

(a) Para. 9.11.2, Sinusoidal Vibration Testing

- 10-55Hz at 8.25mm double amplitude displacement.
- 56-2000Hz at 50g.
- 1 cycle (10-2000-10 Hz) per axis at a sweep rate of 1 octave per minute.

(b) Para. 9.11.3, Random Vibration Testing

- 20-100Hz at +6dB per octave.
- 100-2000Hz, constant at 1.0g<sup>2</sup>/Hz.
- 3 axes.
- 7 minutes per axis.

(c) Para. 9.12.1, Shock: 75g, 11 milliseconds, half sine wave.

(d) Para. 9.24, Jackscrew Retention: Not applicable.

(e) Para. 9.31, Solderability: Not applicable.

###### 4.2.5 Deviations from Lot Acceptance Tests (Chart V)

(a) Para. 9.31, Solderability: Not applicable.

##### 4.3 MECHANICAL REQUIREMENTS

###### 4.3.1 Dimension Check

The dimensions of the connectors specified herein shall be verified in accordance with the requirements set out in Para 9.6 of ESCC Generic Specification No. 3401 and shall conform to those shown in Figure 2 of this specification.

	<p style="text-align: center;">ESCC Detail Specification No. 3401/056</p>	<p style="text-align: right;">PAGE 15 ISSUE 3</p>
---	---	---

4.3.2 Weight

The maximum weight of the connectors specified herein, without contacts, shall be as specified in Table 1(a).

4.3.3 Contact Capability

As specified in ESCC Detail Specifications No. 3401/058 and 3401/066.

4.3.4 Contact Retention (In Insert)

As specified in ESCC Detail Specifications No. 3401/058 and 3401/066. For the 09-01 arrangement, the specified backshell in ESCC Detail Specification No. 3401/062 shall be used.

4.3.5 Mating and Unmating Forces

The forces applied for mating and unmating of the connectors (axial and torque) shall conform to the values specified in Table 1(a).

4.3.6 Insert Retention (In Shell)

Connector inserts shall withstand a pressure of 53.7N/cm<sup>2</sup> without being dislodged from the shell. For the 09-01 arrangement, the specified backshell in ESCC Detail Specification No. 3401/062 shall be used.

4.3.7 Jackscrew Retention

Not applicable.

4.3.8 Contact Insertion and Withdrawal Forces

As specified in ESCC Detail Specifications No. 3401/058 and 3401/066.

4.3.9 Engagement and Separation Forces

As specified in ESCC Detail Specifications No. 3401/058 and 3401/066.

4.3.10 Oversize Pin Exclusion

As specified in ESCC Detail Specifications No. 3401/058 and 3401/066.

4.3.11 Probe Damage

As specified in ESCC Detail Specifications No. 3401/058 and 3401/066.

4.3.12 Solderability

Not applicable.

4.4 MATERIALS AND FINISHES

The materials and finishes shall be as specified herein. Where a definite material is not specified, a material which will enable the connectors specified herein to meet the performance requirements of this specification shall be used. Acceptance or approval of any constituent material does not guarantee acceptance of the finished product.

4.4.1 Shell, Coupling Ring and Nuts

The shell, coupling ring and nuts shall be made of aluminium alloy, dull low reflective electroless nickel plated.

4.4.2 Inserts

Bonded sandwich: Silicone/thermosetting or thermoplastic insert/silicone. For the 09-01 arrangement, the insert shall be made of a thermoplastic material.

4.4.3 Contacts

As specified in the ESCC Detail Specifications No. 3401/058 and 3401/066.

4.4.4 Contact Retaining Clip

The retaining clip shall be made of beryllium copper. Not applicable to the 09-01 arrangement.





4.4.5 Guiding and Locking Devices

Not applicable.

4.4.6 Magnetism Level

Not applicable.

4.5 MARKING

4.5.1 General

The marking of all components delivered to this specification shall be in accordance with the requirements of ESCC Basic Specification No. 21700 and the following paragraphs. Each component shall be marked in respect of:-

- (a) Contact Identification.
- (b) The ESCC Component Number.
- (c) Characteristics.
- (d) Traceability information.

4.5.2 Contact Identification

Contact identification shall be marked in accordance with Figure 2(b).

4.5.3 The ESCC Component Number

The ESCC component number shall be constituted and marked as follows:

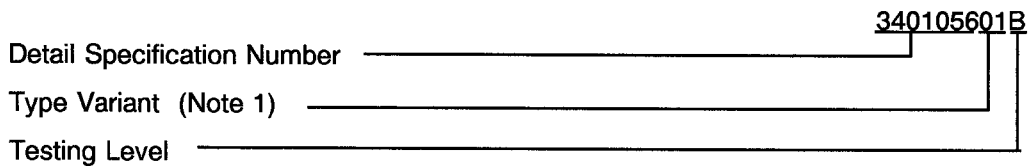

**N.B.**

Marking of the Type Variant is mandatory. No further reference to type variants is made in this specification.

4.5.4 Characteristics

The characteristics to be marked in the following order of precedence are:

- (a) Shell type.
- (b) Contact arrangement.
- (c) Type of contact.
- (d) Clocking position.
- (e) Contact information

The information shall be constituted and marked as follows:-

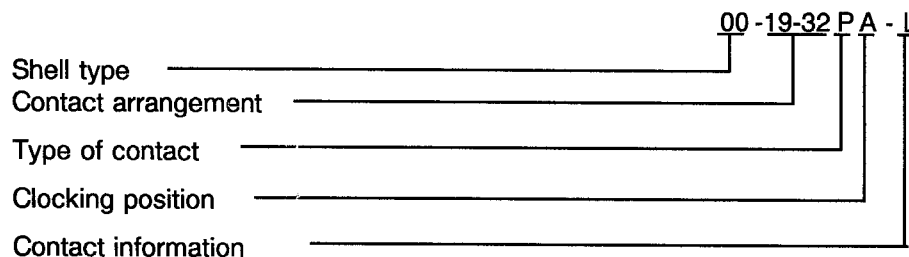

#### 4.5.4.1 Shell Type

The shell type shall be indicated by the numbers specified hereafter.

CODE NO	SHELL TYPE
00	Square flange receptacle
06	Plug with RFI grounding spring
07	Single hole mounting receptacle
66	Plug with mirror image contact numbering with RFI grounding spring (1)

#### NOTES

- Example of "Plug with mirror image contact numbering" is provided below. To be used on the appropriate side of a feedthrough receptacle.

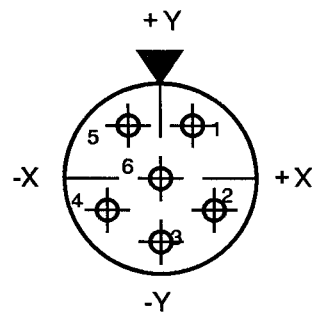

Standard Numbering

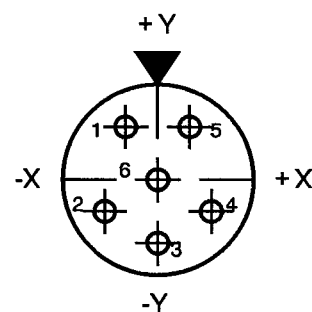

Mirror Image Numbering

#### 4.5.4.2 Contact Arrangements

The number of contacts shall be as shown in Figure 2(b) and contact arrangements shall be indicated by the codes specified hereafter.

CODE	SERVICE RATING
09-01	Not Appl.
09-35	M
09-98	I
11-35	M
11-98	I
11-05	I
11-04	I
13-35	M
13-98	I
13-08	I
13-26	M
13-04	II
15-35	M
15-19	I
15-05	II
15-97	I
15-18	I
17-35	M
17-26	I
17-06	I
17-75	I

CODE	SERVICE RATING
17-08	II
17-99	I
19-35	M
19-32	I
19-11	II
21-35	M
21-41	I
21-16	II
21-11	II
21-39	I
23-35	M
23-53	I
23-21	II
25-35	M
25-61	I
25-19	I
25-29	I
25-43	I
25-24	I
25-46	N
25-03	I
25-07	I

4.5.4.3 Type of Contact

The contact type shall be indicated by the following code letters.

CODE LETTER	CONTACT TYPE
P	Male
S	Female

4.5.4.4 Clocking Position

Clocking positions are as shown in Figure 2(c) and shall be designated by the following code letters: A, B, C, D and E. Code letter N indicates the standard clocking position.

4.5.4.5 Contact Information

L = connector ordered without contacts (without an L = connector delivered with contacts).

This information shall be marked on the packaging and is not marked on the connector.

Contacts shall be obtained from the same Manufacturer as supplied the connector in which they are to be mounted and this shall be verified before assembly.

4.5.5 Traceability Information

Traceability information shall be marked in accordance with the requirements of ESCC Basic Specification No. 21700.

4.5.6 Marking of Small Components

Where it is considered that a component is too small to accommodate the marking as specified above, as much as space permits shall be marked. The order of precedence shall be as specified in Para. 4.5.1. The marking information in full shall accompany each component in its primary package.

4.6 ELECTRICAL MEASUREMENTS

4.6.1 Electrical Measurements at Room Temperature

The parameters to be measured in respect of electrical characteristics are scheduled in Table 2. Unless otherwise specified these measurements shall be performed at  $T_{amb} = +22 \pm 3 \text{ }^\circ\text{C}$ .

4.6.2 Electrical Measurements at High and Low Temperatures (Table 3)

Not applicable.

4.6.3 Circuit for Electrical Measurements (Figure 4)

Not applicable.

4.7 BURN-IN AND ELECTRICAL MEASUREMENTS (TABLES 4 AND 5)

Not applicable.

**TABLE 2 - ELECTRICAL MEASUREMENTS AT ROOM TEMPERATURE**

NO	CHARACTERISTICS	SYMBOL	SPEC. AND/OR TEST METHOD	TEST CONDITION	LIMITS		UNIT
					MIN	MAX	
1	Insulation Resistance	R <sub>i</sub>	ESCC No. 3401 Para 9.1.1.1	Para 9.1.1.1	10 000	-	MΩ
2	Voltage Proof Leakage Current Service II Service I Service M Service N	I <sub>L</sub>	ESCC No. 3401 Para 9.1.1.2	2300Vrms 1800Vrms 1300Vrms 1000Vrms	-	2.0	mA
3	Mated Shell Conductivity (Voltage Drop)	V <sub>d</sub>	ESCC No. 3401 Para. 9.1.1.4	Para. 9.1.1.4 (Note 1)	-	1.0	mV

**NOTES**

1. Applicable to mated connectors with grounding option.

**TABLES 3, 4 AND 5**

Not applicable.

**4.8 ENVIRONMENTAL AND ENDURANCE TESTS (CHARTS IV AND V OF ESCC GENERIC SPECIFICATION NO. 3401)**

**4.8.1 Measurements and Inspections on Completion of Environmental Tests**

The parameters to be measured and inspections to be performed on completion of environmental testing shall be those specified in Table 6. Unless otherwise specified, the measurements shall be performed at T<sub>amb</sub> = +22 ± 3 °C.

**4.8.2 Measurements and Inspections at Intermediate Points during Endurance Tests.**

Not applicable.

**4.8.3 Measurements and Inspections on Completion of Endurance Tests**

The parameters to be measured and inspections to be performed on completion of endurance tests shall be those specified in Table 6. Unless otherwise specified, the measurements shall be performed at T<sub>amb</sub> = +22 ± 3 °C.

**4.8.4 Conditions for Operating Life Test (Part of Endurance Testing)**

Not applicable.

**4.8.5 Electrical Circuits for Operating Life Test**

Not applicable.

**4.8.6 Conditions for High Temperature Storage Test (Part of Endurance Testing)**

The requirements for the high temperature storage test are specified in Section 9 of ESCC Generic Specification No. 3401. The conditions for high temperature storage testing shall be the maximum temperature specified in Table 1(b) of this specification.

**TABLE 6 - MEASUREMENTS AND INSPECTIONS ON COMPLETION OF ENVIRONMENTAL AND ENDURANCE TESTS**

NO.	ESCC GENERIC NO. 3401		MEASUREMENTS AND INSPECTIONS		SYMBOL	LIMITS		UNIT
	ENVIRONMENTAL AND ENDURANCE TESTS (1)	TEST METHOD AND CONDITIONS	IDENTIFICATION	CONDITIONS		MIN	MAX	
01	Seal Test	Para. 9.9	ESCC 3401 Para. 9.9			Not applicable		
02	Wiring	Para. 9.10	ESCC 3401/058			-	-	
03	Vibration	Para. 9.11 & Para. 4.2.4 of this spec	<b>Initial Measurements</b> Coupling Screw(s) Unlocking Torque	-	-	Not applicable		
			<b>Final Measurements</b> Full Engagement Coupling Screw(s) Unlocking Torque Drift Visual Examination	-	-	-	-	-
04	Shock or Bump	Para. 9.12 & Para. 4.2.4 of this spec	Full Engagement Visual Examination	-	-	-	-	
05	Climatic Sequence	Para. 9.13	<b>Dry Heat</b> Insulation Resistance	Table 2 Item 1	Ri	1 000	-	MΩ
			<b>Low Air Pressure</b> Voltage Proof Leakage Curr.	250Vrms	I <sub>L</sub>	Table 2 Item 2		
			<b>Damp Heat</b> Insulation Resistance	Table 2 Item 1	Ri	100	-	MΩ
			<b>Final Measurements</b> External Visual Inspection	ESCC 3401 Para. 9.7	-	ESCC 3401 Para. 9.7		
			Insulation Resistance Voltage Proof Leakage Curr.	Table 2 Item 1 Table 2 Item 2	Ri I <sub>L</sub>	Table 2 Item 1 Table 2 Item 2		
06	Plating Thickness	Para. 9.14	Thickness			ESCC 3401/058 or 3401/066		
07	Joint Strength	Para. 9.15	ESCC 3401 Para 9.15			ESCC 3401 Para. 9.15		
08	Rapid Change of Temperature	Para. 9.16	Visual Examination Insulation Resistance	-	-	-	-	
			Voltage Proof Leakage Curr.	Table 2 Item 1 Table 2 Item 2	Ri I <sub>L</sub>	Table 2 Item 1 Table 2 Item 2		
09	Contact Retention (In insert)	Para. 9.17 & Para. 4.3.4 of this spec.	Contact Displacement			ESCC 3401 Para. 9.17		
10	Endurance	Para. 9.18	<b>Initial Measurements</b> Mating/Unmating Forces		F	Para. 4.3.5 of this spec.		
			Low Level Contact Resist	ESCC 3401/058 or 3401/066	Rcl	Record Values		
			Mated Shell Conductivity	Table 2 Item 3	Vd	Table 2 Item 3		
			<b>Final Measurements</b> Visual Examination		-	-	-	
			Mating/Unmating Forces		F	Para. 4.3.5 of this spec.		
			Low Level Contact Resistance Drift	ESCC 3401/058 or 3401/066	ΔRcl	ESCC 3401/058 or 3401/066		
			Mated Shell Conductivity	Table 2 Item 3	Vd	Table 2 Item 3		
			Insulation Resistance	Table 2 Item 1	Ri	Table 2 Item 1		
			Voltage Proof Leakage Curr.	Table 2 Item 2	I <sub>L</sub>	Table 2 Item 2		

**NOTES** 1. The tests in this table refer to either Chart IV or V and shall be used as applicable.



**TABLE 6 - MEASUREMENTS AND INSPECTIONS ON COMPLETION OF ENVIRONMENTAL AND ENDURANCE TESTS (CONTINUED)**

NO.	ESCC GENERIC NO. 3401		MEASUREMENTS AND INSPECTIONS		SYMBOL	LIMITS		UNIT
	ENVIRONMENTAL AND ENDURANCE TESTS (1)	TEST METHOD AND CONDITIONS	IDENTIFICATION	CONDITIONS		MIN	MAX	
11	Permanence of Marking	Para. 9.19	As applicable		-	-	-	
12	Mating/Unmating Forces	Para. 9.20	Force		F	Para. 4.3.5 of this spec.		
13	High Temperature Storage	Para. 9.21	<b>Initial Measurements</b> Low Level Contact Resis. Mated Shell Conductivity <b>Final Measurements</b> Visual Examination Mating/Unmating Forces  Low Level Contact Resistance Drift Rated Current Contact Resis.  Mated Shell Conductivity Insulation Resistance Voltage Proof Leakage Curr. Contact Retention (In insert)	ESCC 3401/058 Table 2 Item 3  -  ESCC 3401/058 or 3401/066 ESCC 3401/058 or 3401/066 Table 2 Item 3 Table 2 Item 1 Table 2 Item 2 Para. 4.3.4 of this spec.	Rcl Vd  - F  ΔRcl Rcr  Vd Ri I <sub>L</sub>	Record Values Table 2 Item 3  -   - Para. 4.3.5 of this spec. ESCC 3401/058 or 3401/066 ESCC 3401/058 or 3401/066 Table 2 Item 3 Table 2 Item 1 Table 2 Item 2 ESCC 3401 Para. 9.17		
14	Corrosion	Para. 9.22	Visual Examination	-	-	-	-	
15	Insert Retention (In shell)	Para. 9.23 & Para. 4.3.6 of this spec.	Visual Examination	-	-	Para. 4.3.6		
16	Jackscrew Retention	Para. 9.24 & Para. 4.3.7 of this spec.	Visual Examination	-	-	Not applicable		
17	High Temperature Measurements	Para. 9.25	Insulation Resistance	Table 2 Item 1	Ri	500	-	MΩ
18	Overload Test	Para. 9.26	Internal Temperature Rated Current Contact Resis.  Mated Shell Conductivity Insulation Resistance Voltage Proof Leakage Curr.	ESCC 3401/058 or 3401/066 Table 2 Item 3 Table 2 Item 1 Table 2 Item 2	T Rcr  Vd Ri I <sub>L</sub>	-	+100	°C
19	Maintenance Aging	Para. 9.27	Visual Examination Contact Retention  Contact Insertion & Withdrawal Forces	- Para. 4.3.4 of this spec Para. 4.3.8 of this spec	-	-	-	ESCC 3401 Para. 9.17 Para. 4.3.8

**NOTES**

1. The tests in this table refer to either Chart IV or V and shall be used as applicable.



**TABLE 6 - MEASUREMENTS AND INSPECTIONS ON COMPLETION OF ENVIRONMENTAL AND ENDURANCE TESTS (CONTINUED)**

NO.	ESCC GENERIC NO. 3401		MEASUREMENTS AND INSPECTIONS		SYMBOL	LIMITS		UNIT
	ENVIRONMENTAL AND ENDURANCE TESTS (1)	TEST METHOD AND CONDITIONS	IDENTIFICATION	CONDITIONS		MIN	MAX	
20	Engage/Separation Forces	Para. 9.28 & Para. 4.3.9 of this spec.	Force		F	Para. 4.3.9		
21	Oversize Pin Exclusion	Para. 9.29 & Para. 4.3.10 of this spec.				ESCC 3401 Para. 9.29		
22	Probe Damage	Para. 9.30 & Para. 4.3.11 of this spec.	Contact Separation Force	Para. 4.3.9 of this spec.	F	Para. 4.3.9		
23	Solderability	Para. 9.31 & Para. 4.3.12 of this spec.				Para. 4.3.12		

**NOTES**

1. The tests in this table refer to either Chart IV or V and shall be used as applicable.