



Pages 1 to 16

**DIODES, POWER RECTIFIER,
HIGH EFFICIENCY, FAST RECOVERY,
BASED ON TYPE BYV54-200
ESCC Detail Specification No. 5103/031**

**ISSUE 1
January 2003**



Document Custodian: European Space Agency - see <https://escies.org>

	ESCC Detail Specification No. 5103/031		PAGE i ISSUE 1
--	---	--	-------------------

LEGAL DISCLAIMER AND COPYRIGHT

European Space Agency, Copyright © 2003. All rights reserved.

The European Space Agency disclaims any liability or responsibility, to any person or entity, with respect to any loss or damage caused, or alleged to be caused, directly or indirectly by the use and application of this ESCC publication.

This publication, without the prior permission of the European Space Agency and provided that it is not used for a commercial purpose, may be:

- copied in whole in any medium without alteration or modification.
- copied in part, in any medium, provided that the ESCC document identification, comprising the ESCC symbol, document number and document issue, is removed.



DOCUMENTATION CHANGE NOTICE

(Refer to <https://escies.org> for ESCC DCR content)

DCR No.	CHANGE DESCRIPTION



TABLE OF CONTENTS

	<u>Page</u>
1. <u>GENERAL</u>	5
1.1 Scope	5
1.2 Component Type Variants	5
1.3 Maximum Ratings	5
1.4 Parameter Derating Information	5
1.5 Physical Dimensions	5
1.6 Functional Diagram	5
1.7 High Temperature Test Precautions	5
1.8 Handling Precautions	5
2. <u>APPLICABLE DOCUMENTS</u>	5
3. <u>TERMS, DEFINITIONS, ABBREVIATIONS, SYMBOLS AND UNITS</u>	5
4. <u>REQUIREMENTS</u>	9
4.1 General	9
4.2 Deviations from Generic Specification	9
4.2.1 Deviations from Special In-process Controls	9
4.2.2 Deviations from Final Production Tests	9
4.2.3 Deviations from Burn-in and Electrical Measurements	9
4.2.4 Deviations from Qualification Tests	9
4.2.5 Deviations from Lot Acceptance Tests	9
4.3 Mechanical Requirements	9
4.3.1 Dimension Check	9
4.3.2 Weight	9
4.3.3 Terminal Strength	9
4.4 Materials and Finishes	9
4.4.1 Case	10
4.4.2 Lead Material and Finish	10
4.5 Marking	10
4.5.1 General	10
4.5.2 Lead Identification	10
4.5.3 The SCC Component Number	10
4.5.4 Traceability Information	10
4.6 Electrical Measurements	10
4.6.1 Electrical Measurements at Room Temperature	10
4.6.2 Electrical Measurements at High and Low Temperatures	10
4.6.3 Circuits for Electrical Measurements	11
4.7 Burn-in Tests	11
4.7.1 Parameter Drift Values	11
4.7.2 Conditions for High Temperature Reverse Bias Burn-in	11
4.7.3 Conditions for Power Burn-in	11
4.7.4 Electrical Circuits for High Temperature Reverse Bias Burn-in	11
4.7.5 Electrical Circuits for Power Burn-in	11
4.8 Environmental and Endurance Tests	15
4.8.1 Electrical Measurements on Completion of Environmental Tests	15
4.8.2 Electrical Measurements at Intermediate Points and on Completion of Endurance Tests	15
4.8.3 Conditions for Operating Life Tests	15
4.8.4 Electrical Circuits for Operating Life Tests	15
4.8.5 Conditions for High Temperature Storage Test	15

**TABLES**

		<u>Page</u>
1(a)	Type Variants	6
1(b)	Maximum Ratings	6
2	Electrical Measurements at Room Temperature - d.c. Parameters	12
	Electrical Measurements at Room Temperature - a.c. Parameters	12
3(a)	Electrical Measurements at High Temperature	13
3(b)	Electrical Measurements at Low Temperature	13
4	Parameter Drift Values	13
5(a)	Conditions for High Temperature Reverse Bias Burn-in	14
5(b)	Conditions for Power Burn-in and Operating Life Tests	14
6	Electrical Measurements at Intermediate Points and on Completion of Endurance Testing	15

FIGURES

1	Parameter Derating Information	7
2	Physical Dimensions	8
3	Functional Diagram	8
4	Circuits for Electrical Measurements	13
5(a)	Electrical Circuit for High Temperature Reverse Bias Burn-in	14
5(b)	Electrical Circuit for Power Burn-in and Operating Life Tests	14

APPENDICES (Applicable to specific Manufacturers only)

'A'	Agreed Deviations for STMicroelectronics (F)	16
-----	--	----

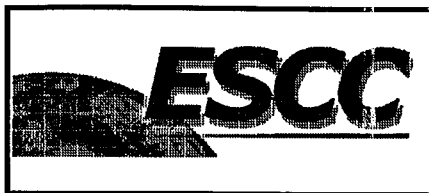
	<p style="text-align: center;">ESCC Detail Specification No. 5103/031</p>	<p style="text-align: right;">PAGE 5 ISSUE 1</p>
--	---	--

1. GENERAL

1.1 SCOPE

This specification details the ratings, physical and electrical characteristics, test and inspection data for Diodes, Power Rectifier, High Efficiency, based on Type BYV54-200. It shall be read in conjunction with ESCC Generic Specification No.5000, the requirements of which are supplemented herein.

1.2 COMPONENT TYPE VARIANTS

Variants of the basic type diodes specified herein, which are also covered by this specification, are given in Table 1(a).

1.3 MAXIMUM RATINGS

The maximum ratings, which shall not be exceeded at any time during use or storage, applicable to the diodes specified herein, are as scheduled in Table 1(b).

1.4 PARAMETER DERATING INFORMATION

The derating information applicable to the diodes specified herein is shown in Figure 1.

1.5 PHYSICAL DIMENSIONS

The physical dimensions of the diodes specified herein are shown in Figure 2.

1.6 FUNCTIONAL DIAGRAM

The functional diagram, showing terminal identification of the diodes specified herein, is shown in Figure 3.

1.7 HIGH TEMPERATURE TEST PRECAUTIONS

For tin-lead plated or solder-dipped lead finish, all tests to be performed at a temperature that exceeds +125°C shall be carried out in a 100% inert atmosphere.

1.8 HANDLING PRECAUTIONS

These devices are susceptible to damage by electrostatic discharge. Therefore, suitable precautions shall be employed for protection during all phases of manufacture, testing, packaging, shipment and any handling.

2. APPLICABLE DOCUMENTS

The following documents form part of this specification and shall be read in conjunction with it:-

- (a) ESCC Generic Specification No. 5000 for Discrete Semiconductors.
- (b) MIL-STD-750, Test Methods and Procedures for Semiconductor Devices.

3. TERMS, DEFINITIONS, ABBREVIATIONS, SYMBOLS AND UNITS

For the purpose of this specification, the terms, definitions, abbreviations, symbols and units specified in ESCC Basic Specification No. 21300 shall apply. In addition, the following abbreviation is used:-

C_J = Junction Capacitance.

	<p style="text-align: center;">ESCC Detail Specification No. 5103/031</p>	<p style="text-align: right;">PAGE 6 ISSUE 1</p>
--	---	--

TABLE 1(a) - TYPE VARIANTS

VARIANT	BASED ON TYPE	CASE	FIGURE	LEAD MATERIAL AND FINISH
01	BYV54-200FSY	TO254	2	H9

TABLE 1(b) - MAXIMUM RATINGS

No.	CHARACTERISTICS	SYMBOL	MAXIMUM RATINGS	UNIT	REMARKS
1	Forward Surge Current	I_{FSM}	400	A	Note 1
2	Repetitive Peak Reverse Voltage	V_{RRM}	200	V	
3	Average Output Rectified Current	I_O	40	A	Note 2
4	RMS Forward Current	$I_{F(RMS)}$	60	A	
5	Junction Temperature	T_J	+ 150	°C	
6	Storage Temperature Range	T_{stg}	- 55 to + 150	°C	
7	Soldering Temperature	T_{sol}	+ 260	°C	Note 3
8	Thermal Resistance (Junction to Case)	$R_{TH(J-C)}$	0.85	°C/W	

NOTES

1. Sinusoidal, with period = 10ms.
2. At $T_{case} \leq +110^{\circ}C$. For derating at $T_{case} > +110^{\circ}C$, see Figure 1.
3. Duration 10 seconds maximum at a distance of not less than 1.5mm from the device body and the same lead shall not be resoldered until 3 minutes have elapsed.

FIGURE 1 - PARAMETER DERATING INFORMATION

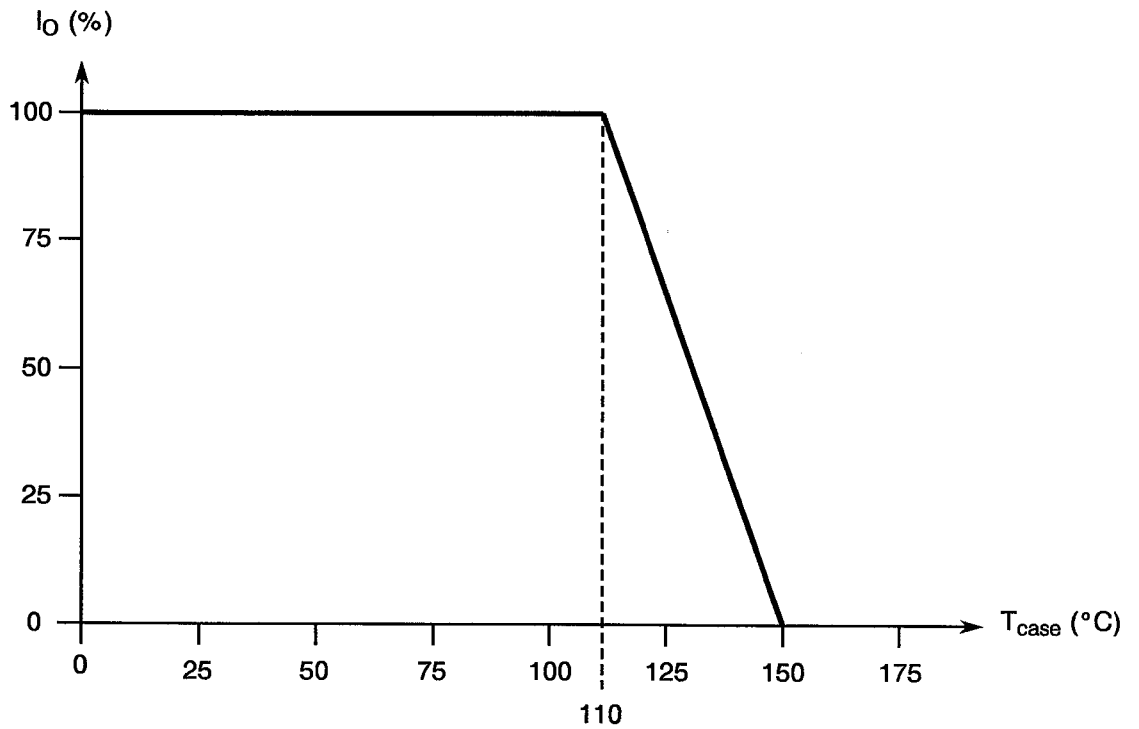

Average Output Rectified Current versus Temperature

FIGURE 2 - PHYSICAL DIMENSIONS

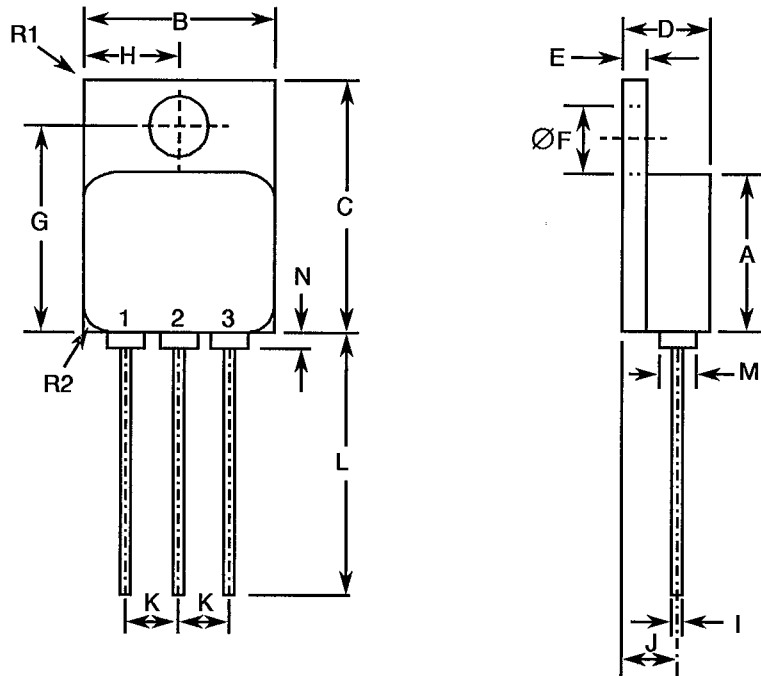

SYMBOL	MILLIMETRES	
	MIN.	MAX.
A	13.59	13.84
B	13.59	13.84
C	20.07	20.32
D	6.3	6.7
E	1.0	1.35
ØF	3.5	3.9
G	16.89	17.4
H	6.86 Typical	
I	0.89	1.14
J	3.81 Typical	
K	3.81 Typical	
L	12.95	14.5
M	3.05 Typical	
N	-	0.71
R1	-	1.0
R2	1.65 Typical	

NOTES

1. All terminals are isolated from case.

FIGURE 3 - FUNCTIONAL DIAGRAM

Terminal 1: Cathode
Terminal 2: N.C.
Terminal 3: Anode



NOTES

1. All terminals are isolated from case.



4. REQUIREMENTS

4.1 GENERAL

The complete requirements for procurement of the diodes specified herein are as stated in this specification and ESCC Generic Specification No. 5000 for Discrete Semiconductors. Deviations from the Generic Specification, applicable to this specification only, are listed in Para. 4.2.

Deviations from the applicable Generic Specification and this Detail Specification, formally agreed with specific Manufacturers on the basis that the alternative requirements are equivalent to the ESCC requirements and do not affect the components' reliability, are listed in the appendices attached to this specification.

4.2 DEVIATIONS FROM GENERIC SPECIFICATION

4.2.1 Deviations from Special In-process Controls

None.

4.2.2 Deviations from Final Production Tests (Chart II)

None.

4.2.3 Deviations from Burn-in and Electrical Measurements (Chart III)

(a) Para. 9.9.5, Safe Operating Area: Not applicable.

4.2.4 Deviations from Qualification Tests (Chart IV)

(a) Para. 9.15, Constant Acceleration: Not applicable.

4.2.5 Deviations from Lot Acceptance Tests (Chart V)

(a) Para. 9.15, Constant Acceleration: Not applicable.

4.3 MECHANICAL REQUIREMENTS

4.3.1 Dimension Check

The dimensions of the diodes specified herein shall be checked. They shall conform to those shown in Figure 2.

4.3.2 Weight

The maximum weight of the diodes specified herein shall be 10 grammes.

4.3.3 Terminal Strength

The requirements for terminal strength testing are specified in Section 9 of ESCC Generic Specification No. 5000. The test conditions shall be as follows:-

Test Condition: 'A' (Tension).

Applied Force: 10 Newtons.

Duration: 10 seconds.

4.4 MATERIALS AND FINISHES

The materials and finishes shall be as specified herein. Where a definite material is not specified, a material which will enable the diodes specified herein to meet the performance requirements of this specification shall be used. Acceptance or approval of any constituent material does not guarantee acceptance of the finished product.

4.4.1 Case

The case shall be hermetically sealed and have a metal body. The Fe/Ni copper core pin shall pass through a ceramic eyelet brazed into the frame and the lid shall be welded.

4.4.2 Lead Material and Finish

The lead material shall be 'H' with Type '9' finish in accordance with the requirements of ESCC Basic Specification No. 23500. (See Table 1(a) for Type Variants).

4.5 MARKING

4.5.1 General

The marking of all components delivered to this specification shall be in accordance with the requirements of ESCC Basic Specification No. 21700 and the following paragraphs. When the component is too small to accommodate all of the marking specified, as much as space permits shall be marked and the marking information, in full, shall accompany the component in its primary package.

The information to be marked and the order of precedence, shall be as follows:-

- (a) Lead Identification.
- (b) The SCC Component Number.
- (c) Traceability Information.

4.5.2 Lead Identification

Lead identification shall be as shown in Figures 2 and 3 of this specification.

4.5.3 The SCC Component Number

Each component shall bear the SCC Component Number which shall be constituted and marked as follows:

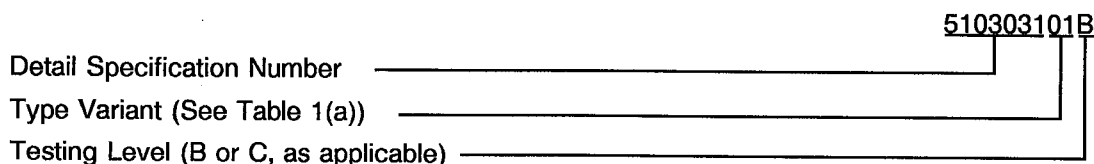

4.5.4 Traceability Information

Each component shall be marked in respect of traceability information in accordance with the requirements of ESCC Basic Specification No. 21700.

4.6 ELECTRICAL MEASUREMENTS

4.6.1 Electrical Measurements at Room Temperature

The parameters to be measured at room temperature are scheduled in Table 2. Unless otherwise stated, the measurements shall be performed at $T_{amb} = +22 \pm 3$ °C.

4.6.2 Electrical Measurements at High and Low Temperatures

The parameters to be measured at high and low temperatures are scheduled in Table 3. Unless otherwise specified, the measurements in Table 3(a) shall be performed at $T_{case} = +125(+0 - 5)$ °C and the measurement in Table 3(b) at $T_{case} = -55(+5 - 0)$ °C.

	<p style="text-align: center;">ESCC Detail Specification No. 5103/031</p>		<p>PAGE 11 ISSUE 1</p>
--	---	--	----------------------------

4.6.3 Circuits for Electrical Measurements (Figure 4)

Not applicable.

4.7 BURN-IN TESTS

4.7.1 Parameter Drift Values

The parameter drift values applicable to burn-in are specified in Table 4 of this specification. Unless otherwise stated, measurements shall be performed at $T_{amb} = +22 \pm 3$ °C. The parameter drift values (Δ) applicable to the parameters scheduled, shall not be exceeded. In addition to these drift value requirements, the appropriate limit value specified for a given parameter in Table 2 shall not be exceeded.

4.7.2 Conditions for High Temperature Reverse Bias Burn-in

The requirements for high temperature reverse bias burn-in are specified in Section 7 of ESCC Generic Specification No. 5000. The conditions for high temperature reverse bias burn-in shall be as specified in Table 5(a) of this specification.

4.7.3 Conditions for Power Burn-in

The requirements for power burn-in are specified in Section 7 of ESCC Generic Specification No. 5000. The conditions for power burn-in shall be as specified in Table 5(b) of this specification.

4.7.4 Electrical Circuits for High Temperature Reverse Bias Burn-in (Figure 5(a))

Not applicable.

4.7.5 Electrical Circuits for Power Burn-in (Figure 5(b))

Not applicable.

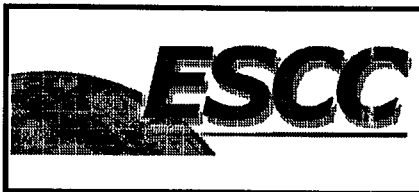

TABLE 2 - ELECTRICAL MEASUREMENTS AT ROOM TEMPERATURE - d.c. PARAMETERS

No.	CHARACTERISTICS	SYMBOL	MIL-STD-750 TEST METHOD	TEST CONDITIONS	LIMITS		UNIT
					MIN.	MAX.	
1	Forward Voltage Drop 1	V_{F1}	4011	$I_F = 20A$ (Note 1)	-	1.1	V
2	Forward Voltage Drop 2	V_{F2}	4011	$I_F = 30A$ (Note 1)	-	1.3	V
3	Reverse Current	I_R	4016	D.C. Method $V_R = V_{RWM} = 200V$	-	50	μA
4	Breakdown Voltage	$V_{(BR)}$	4021	$I_R = 100\mu A$	200	-	V

NOTES

1. Pulsed measurement: Pulse Width $\leq 300\mu s$, Duty Cycle $\leq 2.0\%$.

TABLE 2 - ELECTRICAL MEASUREMENTS AT ROOM TEMPERATURE - a.c. PARAMETERS

No.	CHARACTERISTICS	SYMBOL	MIL-STD-750 TEST METHOD	TEST CONDITIONS	LIMITS		UNIT
					MIN.	MAX.	
5	Junction Capacitance	C_J	4001	$V_R = 10V$ $f = 1.0MHz$	-	400	pF
6	Reverse Recovery Time	t_{rr}	4031 Cond. 'B'	$I_F = 1.0A$ $V_R = 30V$ $di_F/dt = -50A/\mu s$	-	60	ns
7	Thermal Impedance	$Z_{TH(J-C)}$	3101 (Calculate ΔV_F , see Note 1)	$I_H = 15$ to $40A$ $t_H = 50ms$ $I_M = 50mA$ $t_{md} = 100\mu s$ (Note 2)	-	1.0	$^{\circ}C/W$

NOTES

1. The limits for ΔV_F shall be defined by the manufacturer on a lot-by-lot basis.
2. During Chart II only, go-no-go.



TABLE 3(a) - ELECTRICAL MEASUREMENTS AT HIGH TEMPERATURE

No.	CHARACTERISTICS	SYMBOL	MIL-STD-750 TEST METHOD	TEST CONDITIONS	LIMITS		UNIT
					MIN.	MAX.	
1	Forward Voltage Drop 1	V _{F1}	4011	I _F = 20A T _{case} = +125°C (Note 1)	-	1.0	V
2	Forward Voltage Drop 2	V _{F2}	4011	I _F = 30A T _{case} = +125°C (Note 1)	-	1.1	V
3	Reverse Current	I _R	4016	V _R = 200V T _{case} = +125°C	-	40	mA

NOTES

1. Pulsed measurement: Pulse Width ≤ 300μs, Duty Cycle ≤ 2.0%.

TABLE 3(b) - ELECTRICAL MEASUREMENTS AT LOW TEMPERATURE

No.	CHARACTERISTICS	SYMBOL	MIL-STD-750 TEST METHOD	TEST CONDITIONS	LIMITS		UNIT
					MIN.	MAX.	
1	Forward Voltage Drop 1	V _{F1}	4011	I _F = 20A T _{case} = -55°C (Note 1)	-	1.3	V

NOTES

1. Pulsed measurement: Pulse Width ≤ 300μs, Duty Cycle ≤ 2.0%.

FIGURE 4 - CIRCUITS FOR ELECTRICAL MEASUREMENTS

Not applicable.

TABLE 4 - PARAMETER DRIFT VALUES

No.	CHARACTERISTICS	SYMBOL	SPEC. AND/OR TEST METHOD	TEST CONDITIONS	CHANGE LIMIT (Δ)	UNIT
1	Forward Voltage Drop1	V _{F1}	As per Table 2	As per Table 2	± 70	mV
3	Reverse Current	I _R	As per Table 2	As per Table 2	± 6.0 or (1) ± 100	μA %

NOTES

1. Whichever is greater, referred to the initial value.



TABLE 5(a) - CONDITIONS FOR HIGH TEMPERATURE REVERSE BIAS BURN-IN

No.	CHARACTERISTICS	SYMBOL	CONDITION	UNIT
1	Ambient Temperature	T_{amb}	+ 150	°C
2	Reverse Voltage	V_R	160	V
3	Average Output Rectified Current	I_O	0	A
4	Duration	t	48	Hrs

TABLE 5(b) - CONDITIONS FOR POWER BURN-IN AND OPERATING LIFE TESTS

No.	CHARACTERISTICS	SYMBOL	CONDITION	UNIT
1	Case Temperature	T_{case}	+ 130 ± 20 (Note 1)	°C
2	Junction Temperature	T_J	+ 150(+ 0-5)	°C
3	Average Output Rectified Current	I_O	20 (Note 1)	A

NOTES

1. Output current and/or case temperature may be adjusted to attain the specified junction temperature.

FIGURE 5(a) - ELECTRICAL CIRCUIT FOR HIGH TEMPERATURE REVERSE BIAS BURN-IN

Not applicable.

FIGURE 5(b) - ELECTRICAL CIRCUIT FOR BURN-IN AND OPERATING LIFE TESTS

Not applicable.



4.8 ENVIRONMENTAL AND ENDURANCE TESTS (CHARTS IV AND V OF ESCC GENERIC SPECIFICATION NO. 5000)

4.8.1 Electrical Measurements on Completion of Environmental Tests

The parameters to be measured on completion of environmental tests are scheduled in Table 2. Unless otherwise stated, the measurements shall be performed at $T_{amb} = +22 \pm 3$ °C.

4.8.2 Electrical Measurements at Intermediate Points and on Completion of Endurance Tests

The parameters to be measured at intermediate points and on completion of endurance tests are scheduled in Table 6 of this specification. Unless otherwise stated, the measurements shall be performed at $T_{amb} = +22 \pm 3$ °C.

4.8.3 Conditions for Operating Life Tests (Part of Endurance Testing)

The requirements for operating life testing are specified in Section 9 of ESCC Generic Specification No. 5000. The conditions for operating life testing shall be the same as specified in Table 5(b) for the power burn-in.

4.8.4 Electrical Circuits for Operating Life Tests (Figure 5(b))

Not applicable.

4.8.5 Conditions for High Temperature Storage Test (Part of Endurance Testing)

The requirements for the high temperature storage test are specified in Section 9 of ESCC Generic Specification No. 5000. The temperature to be applied shall be the maximum storage temperature specified in Table 1(b) of this specification.

TABLE 6 - ELECTRICAL MEASUREMENTS AT INTERMEDIATE POINTS AND ON COMPLETION OF ENDURANCE TESTING

No.	CHARACTERISTICS	SYMBOL	SPEC. AND/OR TEST METHOD	TEST CONDITIONS	LIMITS		UNIT
					MIN.	MAX.	
1	Forward Voltage Drop 1	V_{F1}	As per Table 2	As per Table 2	-	1.0	V
3	Reverse Current	I_R	As per Table 2	As per Table 2	-	50	μA

	<p>ESCC Detail Specification No. 5103/031</p>		<p>PAGE 16 ISSUE 1</p>
---	---	--	----------------------------

APPENDIX 'A'

Page 1 of 1

AGREED DEVIATIONS FOR STMicroelectronics (F)

ITEMS AFFECTED	DESCRIPTION OF DEVIATIONS
Para. 4.2.2	Para. 9.1 Internal Visual Inspection: Wedge bonds equal to 1.1 wire diameters are acceptable for bonding with V-Groove tool.