



Pages 1 to 57

**CONNECTORS, ELECTRICAL, RECTANGULAR, NON-
REMOVABLE SOLDER BUCKET, PCB AND WIRE-WRAP
CONTACTS AND REMOVABLE COAXIAL AND POWER
CONTACTS, BASED ON TYPE D*M**

ESCC Detail Specification No. 3401/001

Issue 6	November 2011
---------	---------------



Document Custodian: European Space Agency - see <https://escies.org>

LEGAL DISCLAIMER AND COPYRIGHT

European Space Agency, Copyright © 2011. All rights reserved.

The European Space Agency disclaims any liability or responsibility, to any person or entity, with respect to any loss or damage caused, or alleged to be caused, directly or indirectly by the use and application of this ESCC publication.

This publication, without the prior permission of the European Space Agency and provided that it is not used for a commercial purpose, may be:

- copied in whole, in any medium, without alteration or modification.
- copied in part, in any medium, provided that the ESCC document identification, comprising the ESCC symbol, document number and document issue, is removed.

DOCUMENTATION CHANGE NOTICE

(Refer to <https://escies.org> for ESCC DCR content)

DCR No.	CHANGE DESCRIPTION
646, 651, 666	Specification upissued to include editorial and technical changes per DCR.

TABLE OF CONTENTS

1.	<u>GENERAL</u>	<u>6</u>
1.1	Scope	6
1.2	Range of Components and Component Type Variants	6
1.3	Maximum Ratings	6
1.4	Parameter Derating Information	6
1.5	Physical Dimensions	6
2.	<u>APPLICABLE DOCUMENTS</u>	<u>6</u>
3.	<u>TERMS, DEFINITIONS, ABBREVIATIONS, SYMBOLS AND UNITS</u>	<u>7</u>
4.	<u>REQUIREMENTS</u>	<u>43</u>
4.1	General	43
4.2	Deviations from Generic Specification	43
4.2.1	Deviations from Special In-Process Controls	43
4.2.2	Deviations from Final Production Tests (Chart II)	43
4.2.3	Deviations from Burn-in and Electrical Measurements (Chart III)	43
4.2.4	Deviations from Qualification Tests (Chart IV)	43
4.2.5	Deviations from Lot Acceptance Tests (Chart V)	43
4.3	Mechanical Requirements	44
4.3.1	Dimension Check	44
4.3.2	Weight	44
4.3.3	Contact Capability	44
4.3.4	Contact Retention (in insert)	44
4.3.5	Mating and Unmating Forces	44
4.3.6	Insert Retention (in Shell)	44
4.3.7	Jackscrew Retention	44
4.3.8	Contact Insertion and Withdrawal Forces	44
4.3.9	Engagement and Separation Forces	44
4.3.10	Oversize Pin Exclusion	45
4.3.11	Probe Damage	45
4.3.12	Solderability	45
4.4	Material and Finishes	45
4.4.1	Shells	46
4.4.2	Inserts	46
4.4.3	Contacts	46
4.4.4	Contact Retaining Clip	46
4.4.5	Guiding and Locking Devices	46
4.4.6	Magnetism Level	46
4.5	Marking	46
4.5.1	General	46
4.5.2	Contact Position	46
4.5.3	The ESCC Component Number	47
4.5.4	Characteristics	47
4.5.4.1	Series	47
4.5.4.2	Shell Size	47
4.5.4.3	Insert Type	48
4.5.4.4	Mounting	48
4.5.4.5	Contact Arrangement	48
4.5.4.6	Type of Contact	49
4.5.4.7	Magnetism Level	49
4.5.4.8	Contact Termination Code	50
4.5.4.9	Modification Code	50

4.5.5	Traceability Information	50
4.6	Electrical Measurements	50
4.6.1	Electrical Measurements at Room Temperature	50
4.6.2	Electrical Measurements at High and Low Temperatures	50
4.6.3	Circuit for Electrical Measurements (Figure 4)	51
4.7	Burn-in and Electrical Measurements	51
4.8	Environmental and Endurance Tests (Charts IV and V of ESCC Generic Specification No. 3401)	51
4.8.1	Measurements and Inspections on Completion of Environmental Tests	51
4.8.2	Measurements and Inspections at Intermediate Points during Endurance Tests	51
4.8.3	Measurements and Inspections on Completion of Endurance Tests	51
4.8.4	Conditions for Operating Life Test (Part of Endurance Testing)	51
4.8.5	Electrical Circuits for Operating Life Test (Figure 5)	51
4.8.6	Conditions for High Temperature Storage Test (Part of Endurance Testing)	51
APPENDIX A		56
APPENDIX B		57

1. GENERAL

1.1 SCOPE

This specification details the ratings, physical and electrical characteristics, test and inspection data for Connectors, Electrical, Rectangular, Non-removable Solder Bucket, PCB and Wire-wrap Contacts and removable Coaxial and Power Contacts, based on type D*M. It shall be read in conjunction with:

ESCC Generic Specification No. 3401, Connectors, Electrical, Non-Filtered, Circular and Rectangular.

ESCC Detail Specification No. 3401/004, Contacts, Coaxial, Crimp-Type, Solder-Type and PCB-Type for 3401/001 Connectors and Male/Female-Type for 3401/080 Connector Savers.

ESCC Detail Specification No. 3401/022, Accessories for Rectangular Connectors 3401/001, 3401/002 and Connector Savers 3401/020 and 3401/080.

ESCC Detail Specification No. 3401/040, Contacts, Power, Crimp-Type, Solder-Type and PCB-Type for 3401/001 Connectors and Male/Female-Type for 3401/080 Connector Savers.

ESCC Detail Specification No. 3401/072, Lightweight Accessories for Rectangular Connectors 3401/001 and 3401/002.

ESCC Detail Specification No. 3401/085, Fast-locking Screw Lock Assemblies for Rectangular Connectors 3401/001, 3401/002 and Connector Savers 3401/020, 3401/080.

the requirements of which are supplemented herein.

1.2 RANGE OF COMPONENTS AND COMPONENT TYPE VARIANTS

The different sizes of the connectors and contact types specified herein, which are also covered by this specification, together with their mechanical characteristics, are given in Table 1(a).

1.3 MAXIMUM RATINGS

The maximum ratings, which shall not be exceeded at any time during use or storage, applicable to the connectors specified herein, are given in Table 1(b).

1.4 PARAMETER DERATING INFORMATION

The applicable derating information for the connectors specified herein is shown in Figure 1.

1.5 PHYSICAL DIMENSIONS

The physical dimensions of the connectors specified herein and the available contact arrangements are shown in Figure 2.

2. APPLICABLE DOCUMENTS

The following documents form part of this specification and shall be read in conjunction with it:

- (a) ESCC Generic Specification No. 3401 for Connectors, Electrical, Non-Filtered, Circular and Rectangular.
- (b) ESCC Detail Specification No. 3401/004, Contacts, Coaxial, Crimp-Type, Solder-Type and PCB-Type for 3401/001 Connectors and Male/Female-Type for 3401/080 Connector Savers.
- (c) ESCC Detail Specification No. 3401/022, Accessories for Rectangular Connectors, 3401/001,

- 3401/002 and Connector Savers 3401/020 and 3401/080.
- (d) ESCC Detail Specification 3401/040, Contacts, Power, Crimp-Type, Solder-Type and PCB-Type for 3401/001 Connectors and Male/Female-Type for 3401/080 Connector Savers.
 - (e) ESCC Detail Specification No. 3401/072, Lightweight Accessories for Rectangular Connectors 3401/001 and 3401/002.
 - (f) ESCC Detail Specification No. 3401/085, Fast-locking Screw Lock Assemblies for Rectangular Connectors 3401/001, 3401/002 and Connector Savers 3401/020, 3401/080.
 - (g) MIL-DTL-24308, Rack and Panel Connectors, Miniature.
 - (h) NASA/GSFC Specification S-311-P-10, Connectors, Electrical, Rectangular, Miniature, Polarised Shell, Rack and Panel, for Space Flight Use.

3. TERMS, DEFINITIONS, ABBREVIATIONS, SYMBOLS AND UNITS

For the purpose of this specification, the terms, definitions, abbreviations, symbols and units specified in ESCC Basic Specification No. 21300 shall apply.

TABLE 1(a) - RANGE OF COMPONENTS AND TYPE VARIANTS
SHELL SIZES

Variant	Shell Size (1)	Max. Weight (g) (2) (3)		Mating Force (N. max)	Unmating Force	
		Male	Female		N. min	N. max
01 (Gauge 20 Contacts)	E	4.5	5	30	3.5	20
	A	5.5	7	50	4.5	34
	B	9	10	83	8	55
	C	12.5	13.5	123	11	83
	D	13.5	15	166	14.5	120
02 (Gauge 22 Contacts)	E	5.2	6	46	3.4	28
	A	7.4	8	77	4.5	46
	B	11	12	127	7.9	77
	C	15.6	17	177	11.3	109
	D	18.2	20	222	14.7	136
	F	23	25	295	20.3	177

CONTACT TYPES

Contact Codes		Contact Types (4)	Maximum Weight of Contacts (g)			
Tail 0.60	Tail 0.76		Variant 01		Variant 02	
			Male	Female	Male	Female
-	-	Gauge 20 solder bucket contact for wire sizes AWG 20 to 24	0.19	0.22	-	-
-	-	Gauge 22 solder bucket contact for wire sizes AWG 22 to 26	-	-	0.14 (5)	0.19 (5)
			-	-	0.16 (6)	0.21 (6)
			-	-	0.18 (7)	0.23 (7)
OL3	-	Straight PCB contact gauges 20 and 22	0.17	0.2	0.14	0.19
-	Z	Straight PCB contact gauges 20	0.17	0.2	-	-

Contact Codes		Contact Types (4)	Maximum Weight of Contacts (g)			
Tail 0.60	Tail 0.76		Variant 01		Variant 02	
			Male	Female	Male	Female
1A0N	2A0N	Gauge 20 90° PCB solder contact (2.54mm row spacing)	0.24 (8) 0.28 (9) 0.32 (10)	0.29 (8) 0.34 (9) 0.37 (10)	- - -	- - -
1B0N	2B0N	Gauge 20 90° PCB solder contact (2.84mm row spacing)	0.24 (8) 0.28 (9) 0.32 (10)	0.29 (8) 0.34 (9) 0.37 (10)	- - -	- - -
1C0N	-	Gauge 22 90° PCB solder contact (1.98mm row spacing shell sizes E, A, B and C)	- - -	- - -	0.16 (11) 0.18 (12) 0.2 (13)	0.21 (11) 0.23 (12) 0.25 (13)
1D0N	-	Gauge 22 90° PCB solder contact (2.08mm row spacing shell sizes D and F)	- - - - -	- - - - -	0.16 (11) 0.18 (12) 0.2 (13) 0.22 (14) 0.24 (15)	0.21 (11) 0.23 (12) 0.25 (13) 0.27 (14) 0.29 (15)
1(16)7N	2(16)7N	Gauge 20 90° PCB solder contact equipped with 90° bracket and screwlocks 4-40 (17)	0.24 (8) 0.28 (9) 0.32 (10)	0.29 (8) 0.34 (9) 0.37 (10)	- - -	- - -
1(16)9N	2(16)9N	Gauge 20 90° PCB solder contact equipped with 90° bracket and screwlocks M3 (17)	0.24 (8) 0.28 (9) 0.32 (10)	0.29 (8) 0.34 (9) 0.37 (10)	- - -	- - -
1C7N	-	Gauge 22 90° PCB solder contact equipped with 90° bracket and screwlocks 4-40 (1.98mm row spacing shell sizes E, A, B and C)(17)	- -	- -	0.16 (11) 0.18 (12)	0.21 (11) 0.23 (12)

Contact Codes		Contact Types (4)	Maximum Weight of Contacts (g)			
Tail 0.60	Tail 0.76		Variant 01		Variant 02	
			Male	Female	Male	Female
			-	-	0.2 (13)	0.25 (13)
1C9N	-	Gauge 22 90° PCB solder contact equipped with 90° bracket and screwlocks M3 (1.98mm row spacing shell sizes E, A, B and C) (17)	-	-	0.16 (11)	0.21 (11)
			-	-	0.18 (12)	0.23 (12)
			-	-	0.2 (13)	0.25 (13)
1D7N	-	Gauge 22 90° PCB solder contact equipped with 90° bracket and screwlocks 4-40 (2.08mm row spacing shell sizes D and F)(17)	-	-	0.16 (11)	0.21 (11)
			-	-	0.18 (12)	0.23 (12)
			-	-	0.2 (13)	0.25 (13)
			-	-	0.22 (14)	0.27 (14)
			-	-	0.24 (15)	0.29 (15)
1D9N	-	Gauge 22 90° PCB solder contact equipped with 90° bracket and screwlocks M3 (2.08mm row spacing shell sizes D and F) (17)	-	-	0.16 (11)	0.21 (11)
			-	-	0.18 (12)	0.23 (12)
			-	-	0.2 (13)	0.25 (13)
			-	-	0.22 (14)	0.27 (14)
			-	-	0.24 (15)	0.29 (15)
-	P	Gauge 20 90° PCB solder contact (2.84mm row spacing) Narrow Profile	0.22 (8)	0.27 (8)	-	-
			0.26 (9)	0.32 (9)	-	-
			0.3 (10)	0.35 (10)	-	-
-	L7	Gauge 20 90° PCB solder contact equipped with 90° bracket and screwlocks 4-40 (18) Narrow Profile	0.22 (8)	0.27 (8)	-	-
			0.26 (9)	0.32 (9)	-	-
			0.3 (10)	0.35 (10)	-	-
-	L9	Gauge 20 90° PCB solder contact equipped with 90° bracket and screwlocks M3 (18) Narrow Profile	0.22 (8)	0.27 (8)	-	-
			0.26 (9)	0.32 (9)	-	-

Contact Codes		Contact Types (4)	Maximum Weight of Contacts (g)			
Tail 0.60	Tail 0.76		Variant 01		Variant 02	
			Male	Female	Male	Female
			0.3 (10)	0.35 (10)	-	-
F179A		Gauge 20 wire-wrap contact for wire sizes AWG 26 to 30	0.28	0.34	-	-
-		Power and Coaxial contacts (19)	(20)	(20)	-	-

NOTES:

1. See Figure 2(b)
2. Weights without contacts or accessories
3. Total maximum weight may be calculated from:
 - connector weight.
 - contact weight for all contacts including brackets and nuts (as applicable) (see Table 1(a) Contact Types and/or the relevant Detail Specification).
 - Accessories weight given in ESCC Detail Specification Nos. 3401/022, 3401/072 and 3401/085 (if applicable).
4. See Figure 2(c)
5. Weight of contact for the external rows (all sizes).
6. Weight of contact for the middle rows except for the middle row of size F.
7. For size F only, weight of contact in the middle row.
8. Weight of contact in row nearest the connector mounting plane (Ref. Plane)
9. Weight of contact in row farthest from connector mounting plane (Ref. Plane), except for size D, where it is the middle row.
10. For size D only, weight of contact in row farthest from connector mounting plane (Ref. Plane).
11. Weight of contact in row nearest the connector mounting plane (Ref. Plane)
12. Weight of contact in row after the row specified in (11).
13. Weight of contact in row after the row specified in (12).
14. Weight of contact in row after the row specified in (13).
15. For size F only, weight of contact in row farthest from connector mounting plane (Ref. Plane).
16. A or B, as applicable.
17. Maximum Weight of brackets and nuts:
 - Shell sizes E, A, B and C : 3.1g (Var. 01), 3.95g (Var. 02)
 - Shell size D : 3.8g (Var. 01), 4.4g (Var. 02)
 - Shell size F : 5g (Var. 02)
18. Maximum Weight of brackets and nuts:
 - Shell sizes E, A, B and C : 3g (Var. 01)
 - Shell size D : 3.6g (Var. 01)
19. Power and coaxial contacts shall be ordered separately in accordance with ESCC Detail Specification Nos. 3401/040 and 3401/004 respectively.
20. See ESCC Detail Specification Nos. 3401/004 and 3401/040 for coaxial and power contacts.

TABLE 1(b) - MAXIMUM RATINGS

No.	Characteristics	Symbol	Maximum Ratings	Unit	Remarks
1	Working Voltage Sea Level -Gauge 20 Contacts -Gauge 22 Contacts -Power Contacts -Coaxial Contacts	U_R	300 250 250 Note 2	Vrms	Note 1
2	Rated Current -Gauge 20 Contacts -Gauge 22 Contacts -Power Contacts -Coaxial Contacts	I_R	7.5 3 Note 3 Note 2	A	-
3	Operating Temperature Range	T_{op}	-55 to +125	°C	T_{amb}
4	Storage Temperature Range	T_{stg}	-65 to +125	°C	-
5	Soldering Temperature	T_{sol}	+260	°C	Note 4

NOTES:

1. Between contact and shell.
2. See ESCC Detail Specification No. 3401/004 for coaxial contacts.
3. See ESCC Detail Specification No. 3401/040 for power contacts.
4. Duration 10 seconds maximum and the same contacts shall not be resoldered until 3 minutes have elapsed.

FIGURE 1 - PARAMETER DERATING INFORMATION

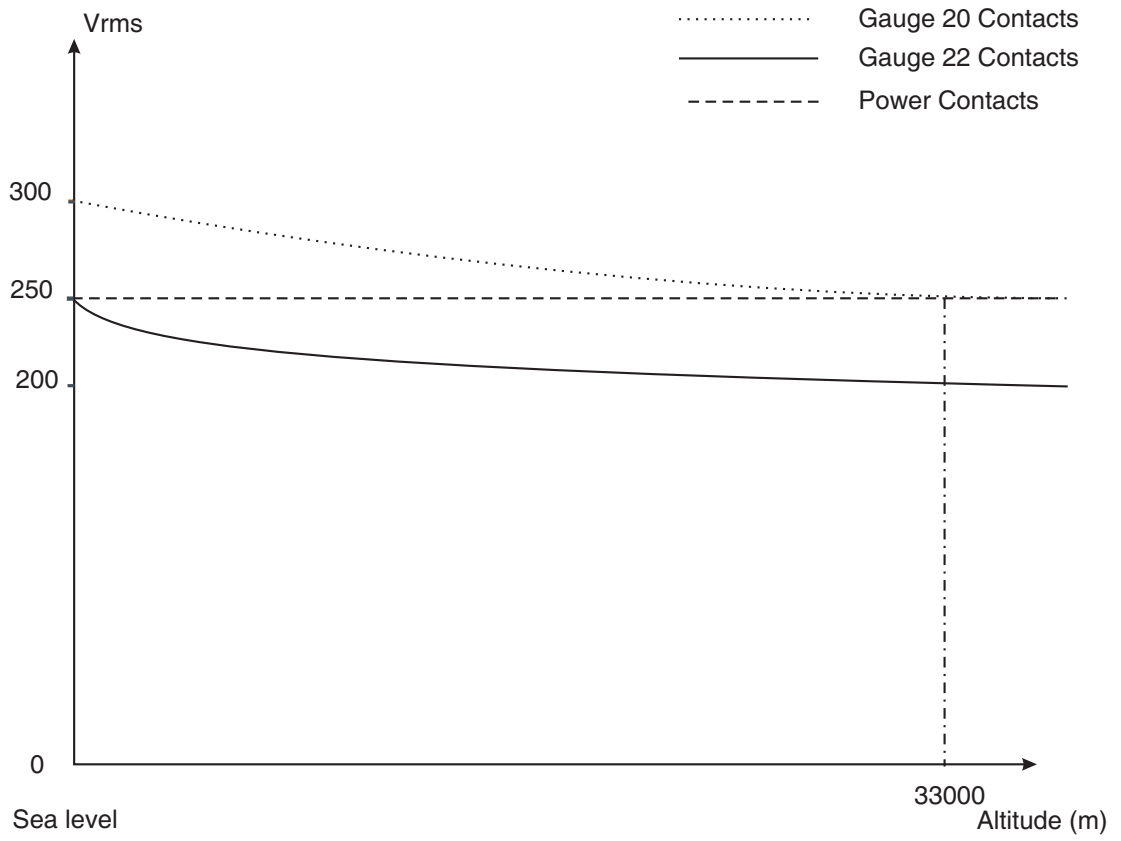

Working Voltage versus Altitude

FIGURE 2 - PHYSICAL DIMENSIONS
FIGURE 2(A) - RECEPTACLES AND PLUGS
SHELL SIZE E

Standard Mounting Holes

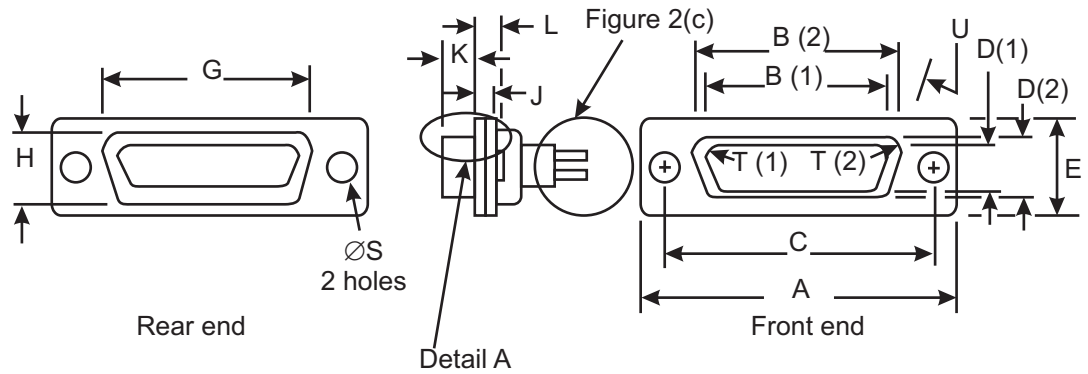

DETAIL A

Spherical. A 0.3mm max. diameter flat is permitted

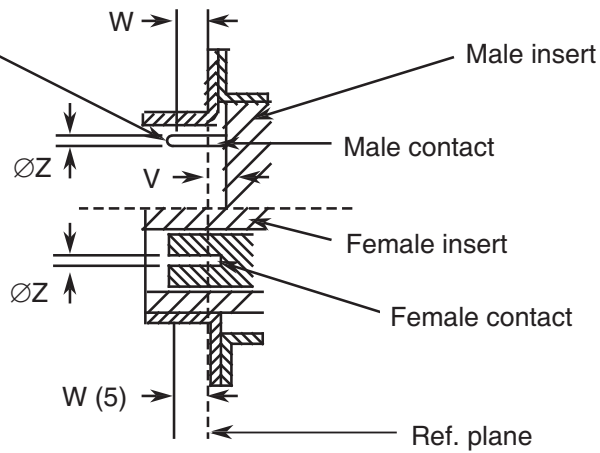

Connector Type	Contact Type	Symbol/Dim.	A	B	C	D	E	G	H	J	K	L	ØS	T	U	V	W	ØZ	
															°			V.01	V.02
Plug	Male	min.	30.43	16.79	24.87	8.23	12.17	19.02	10.46	0.51	5.82	0.89	2.92	2.59	9	0	4.03	0.99	0.75
		max.	31.19	17.04	25.12	8.48	12.93	19.53	10.97	1.02	6.05	1.52	3.2	2.69	11	0.4	-	1.04	0.77
Receptacle	Female	min.	30.43	16.21	24.87	7.77	12.17	19.02	10.46	0.51	6.05	0.89	2.92	2.46	9	-	3.63	1.07	0.89
		max.	31.19	16.46	25.12	8.03	12.93	19.53	10.97	1.02	6.3	1.52	3.2	2.62	11	-	-	1.14	0.95

SHELL SIZE A

Standard Mounting Holes

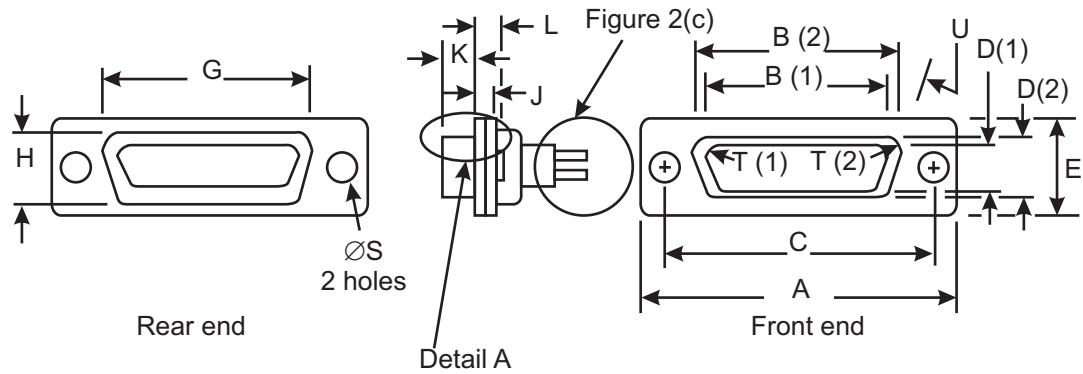

DETAIL A

Spherical. A 0.3mm max. diameter flat is permitted

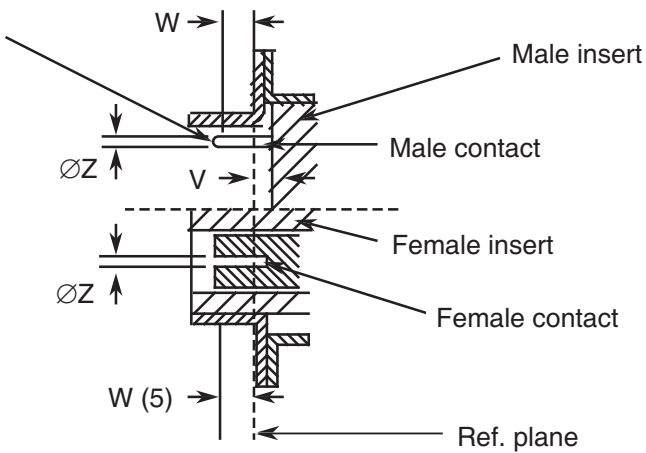

Connector Type	Contact Type	Symbol/Dim.	A	B	C	D	E	G	H	J	K	L	ØS	I	U	V	W	ØZ	
																			V.01
Plug	Male	min.	38.76	25.12	33.2	8.23	12.17	27.25	10.46	0.51	5.82	0.89	2.92	2.59	9	0	4.03	0.99	0.75
		max.	39.52	25.37	33.45	8.48	12.93	27.76	10.97	1.02	6.05	1.52	3.2	2.69	11	0.4	-	1.04	0.77
Receptacle	Female	min.	38.76	25.54	33.2	7.77	12.17	27.25	10.46	0.51	6.05	0.89	2.92	2.46	9	-	3.63	1.07	0.89
		max.	39.52	24.79	33.45	8.03	12.93	27.76	10.97	1.02	6.3	1.52	3.2	2.62	11	-	-	1.14	0.95

SHELL SIZE B

Standard Mounting Holes

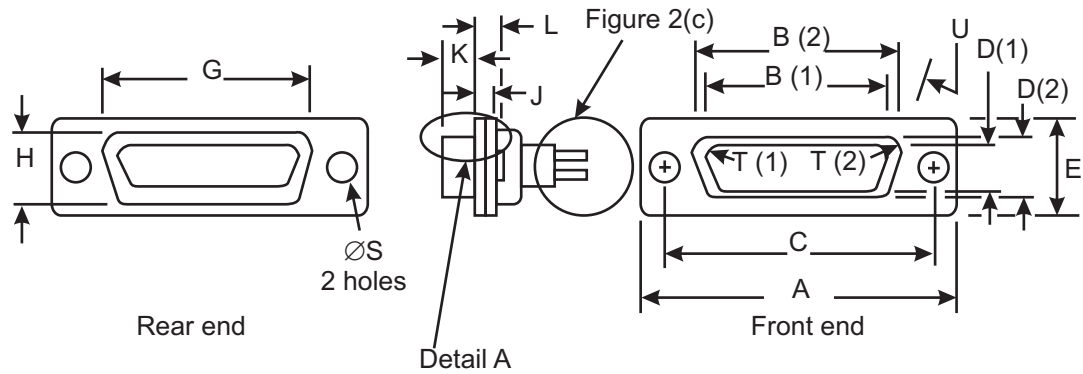

DETAIL A

Spherical. A 0.3mm max. diameter flat is permitted

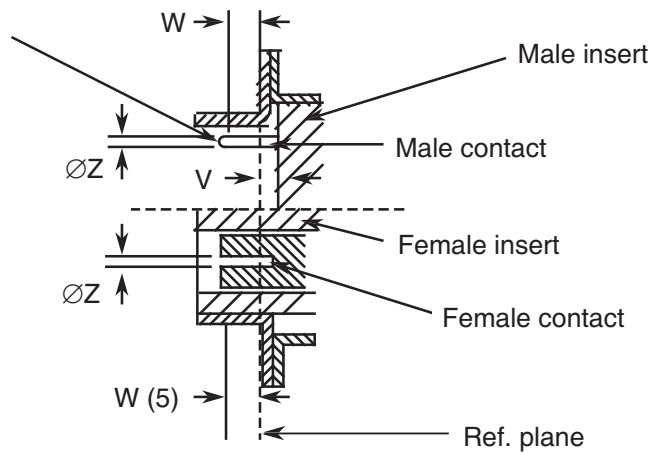

Connector Type	Contact Type	Symbol/Dim.	A	B	C	D	E	G	H	J	K	L	ØS	I	U	V	W	ØZ	
																			V.01
Plug	Male	min.	52.65	38.84	46.91	8.23	12.17	41.02	10.46	0.51	5.69	1.05	2.92	2.59	9	0	3.81	0.99	0.75
		max.	53.42	39.09	47.17	8.48	12.93	41.53	10.97	1.24	5.99	1.78	3.2	2.69	11	0.6	-	1.04	0.77
Receptacle	Female	min.	52.65	38.25	46.91	7.77	12.17	41.02	10.46	0.51	6.05	0.89	2.92	2.46	9	-	3.63	1.07	0.89
		max.	53.42	38.51	47.17	8.03	12.93	41.53	10.97	1.02	6.3	1.52	3.2	2.62	11	-	-	1.14	0.95

SHELL SIZE C

Standard Mounting Holes

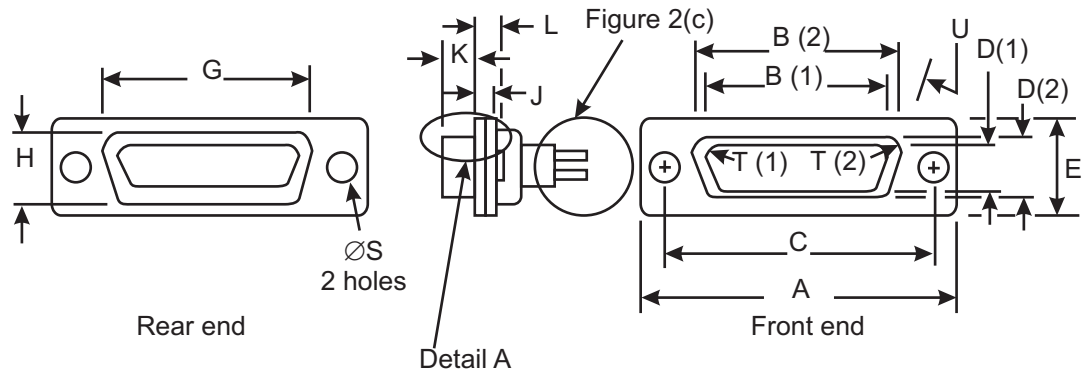

DETAIL A

Spherical. A 0.3mm max. diameter flat is permitted

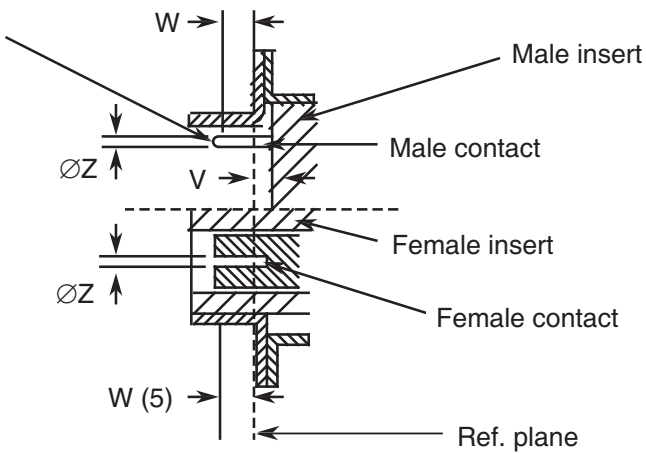

Connector Type	Contact Type	Symbol/Dim.	A	B	C	D	E	G	H	J	K	L	ØS	I	U	V	W	ØZ	
																			V.01
Plug	Male	min.	68.94	55.3	63.37	8.23	12.17	57.45	10.46	0.51	5.69	1.05	2.92	2.59	9	0	3.81	0.99	0.75
		max.	69.7	55.55	63.63	8.48	12.93	57.96	10.97	1.24	5.99	1.78	3.2	2.69	11	0.6	-	1.04	0.77
Receptacle	Female	min.	68.94	54.71	63.37	7.77	12.17	57.45	10.46	0.51	6.05	0.89	2.92	2.46	9	-	3.63	1.07	0.89
		max.	69.7	54.97	63.63	8.03	12.93	57.96	10.97	1.02	6.3	1.52	3.2	2.62	11	-	-	1.14	0.95

SHELL SIZE D

Standard Mounting Holes

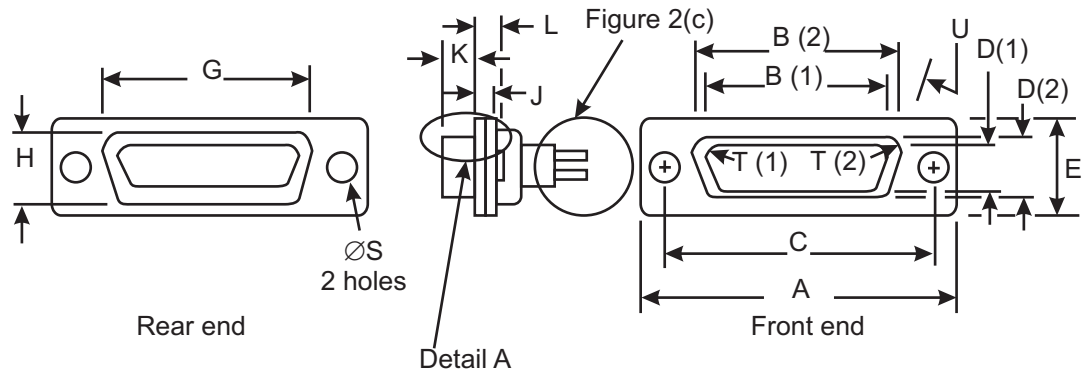

DETAIL A

Spherical. A 0.3mm max. diameter flat is permitted

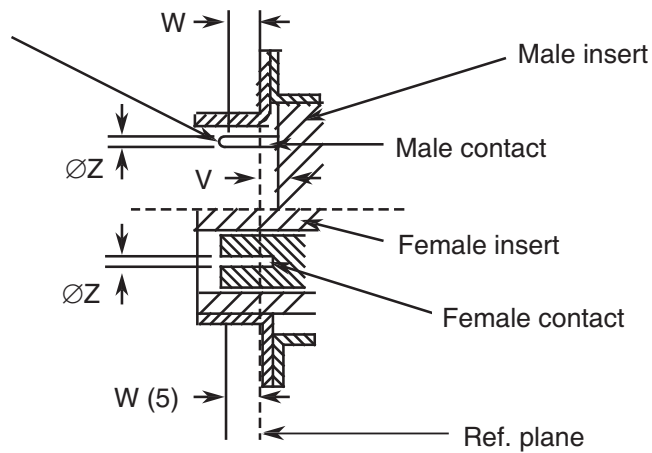

Connector Type	Contact Type	Symbol/Dim.	A	B	C	D	E	G	H	J	L	K	ØS	I	U	V	W	ØZ	
																			V. 01
Plug	Male	min.	66.55	52.68	60.99	11.07	14.99	55.07	13.31	0.51	1.05	5.69	2.92	2.59	9	0	3.81	0.99	0.75
		max.	67.31	52.93	61.24	11.33	15.75	55.58	13.82	1.24	1.78	5.99	3.2	2.69	11	0.6	-	1.04	0.77
Receptacle	Female	min.	66.55	52.3	60.99	10.62	14.99	55.07	13.31	0.51	0.89	6.05	2.92	2.46	9	-	3.63	1.07	0.89
		max.	67.31	52.55	61.24	10.87	15.75	55.58	13.82	1.02	1.52	6.3	3.2	2.62	11	-	-	1.14	0.95

SHELL SIZE F

Standard Mounting Holes

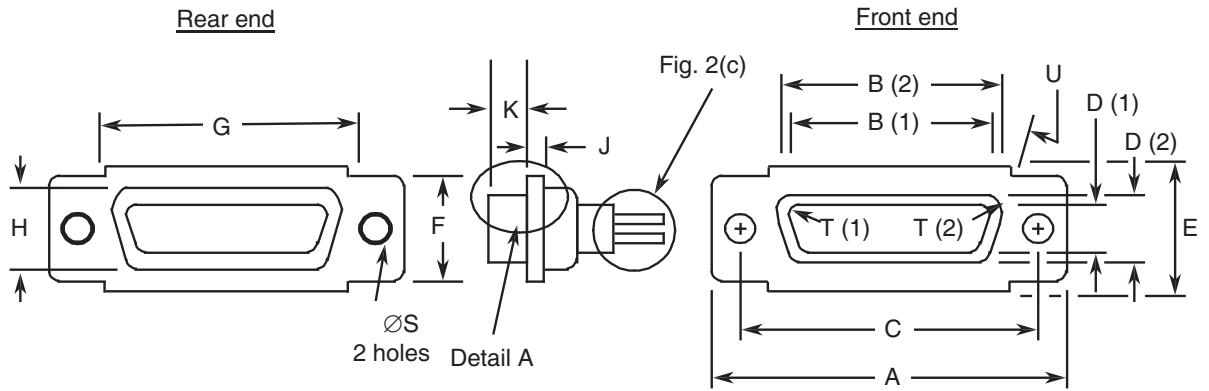

DETAIL A

Spherical. A 0.3mm max. diameter flat is permitted

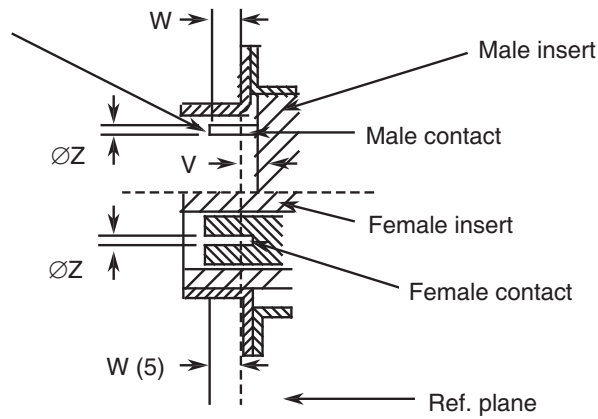

Connector Type	Contact Type	Symbol/Dim.	A	B	C	D	E	F	G	H	J	K	ØS	I	U °	V	W	ØZ
Plug	Male	min.	68.94	56.06	63.37	12.65	16.92	14.99	57.25	15.45	0.74	5.69	2.92	2.59	9	0	3.81	0.75
		max.	69.7	56.31	63.63	12.9	17.68	15.75	57.75	15.95	1.24	5.99	3.2	2.69	11	0.6	-	0.77
Receptacle	Female	min.	68.94	55.47	63.37	12.19	16.92	14.99	57.25	15.45	0.51	6.05	2.92	2.46	9	-	3.63	0.89
		max.	69.7	55.73	63.63	12.45	17.68	15.75	57.75	15.95	1.02	6.3	3.2	2.62	11	-	-	0.95

OTHER MOUNTING TYPES

Floating Mount - Type 'Y'
Shell Sizes E, A, B, C, D and F

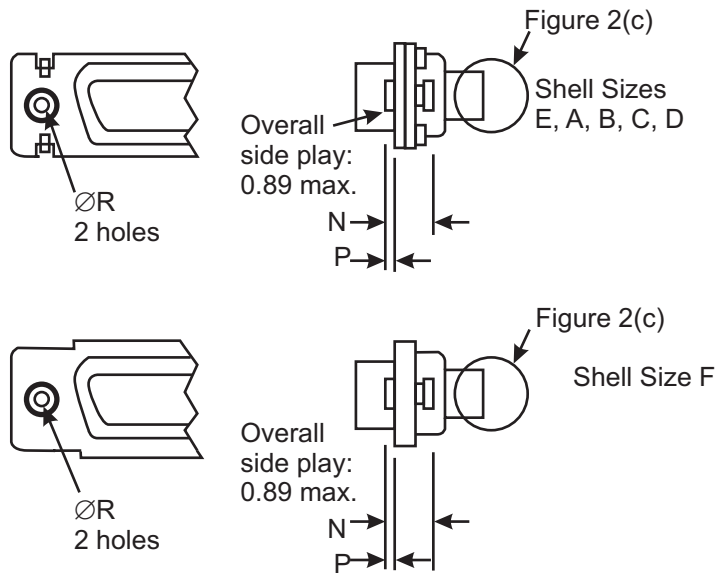

Contact Type	Symbol/Dim	N	P	ØR
Male	min.	2.4	0.76	2.2
	max.	3.3	0.86	2.3
Female	min.	2.4	0.76	2.2
	max.	3.3	0.86	2.3

Captive Nut - Type 'E'
Shell Sizes E, A, B, C, D and F

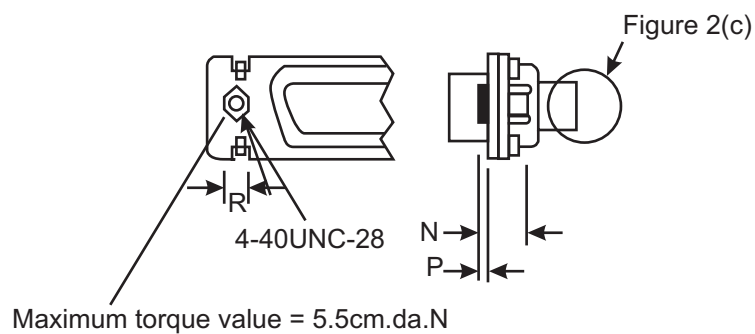

Contact Type	Symbol/Dim	N	P	R
Male	min.	3.4	0	4.3
	max.	4.2	0.4	4.7

Contact Type	Symbol/Dim	N	P	R
Female	min.	3.4	0	4.3
	max.	4.2	0.4	4.7

NOTES:

1. Inside dimension for connectors with male contacts.
2. Outside dimension for connectors with female contacts.
3. All dimensions are in millimetres (angles in degrees).
4. Underlined dimensions, in table, are critical to ensure intermateability.
5. Electrical contact position in female contact.

FIGURE 2(b) CONTACT ARRANGEMENTS

VARIANT 01 - STANDARD CONTACT ARRANGEMENTS
FRONT VIEW MALE INSERT

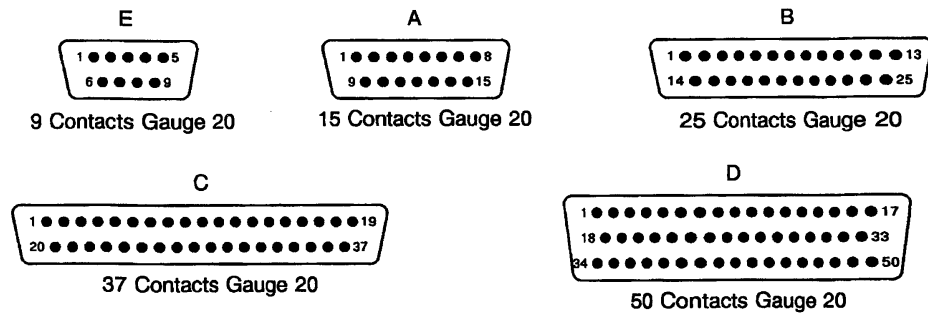

VARIANT 02 - HIGH DENSITY CONTACT ARRANGEMENTS
FRONT VIEW MALE INSERT

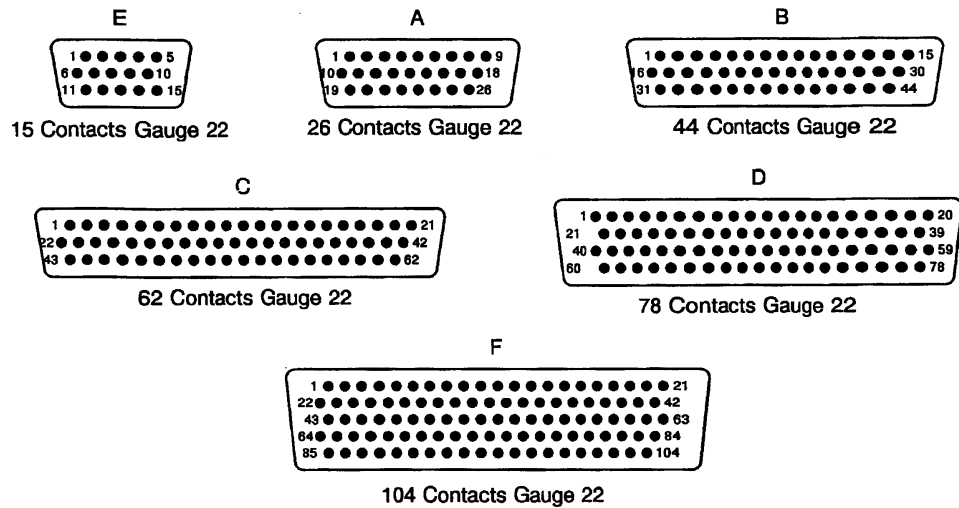

POWER AND COAXIAL CONTACT ARRANGEMENTS (Variant 01)

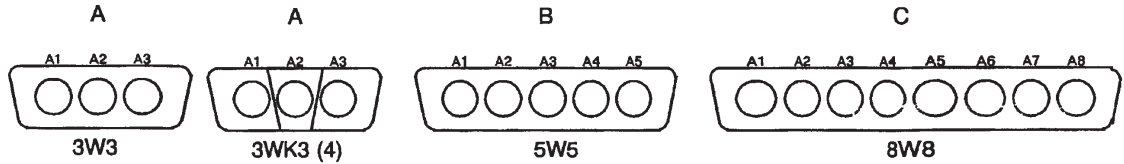

MIXED CONTACT ARRANGEMENTS FOR VARIANT 01 ONLY

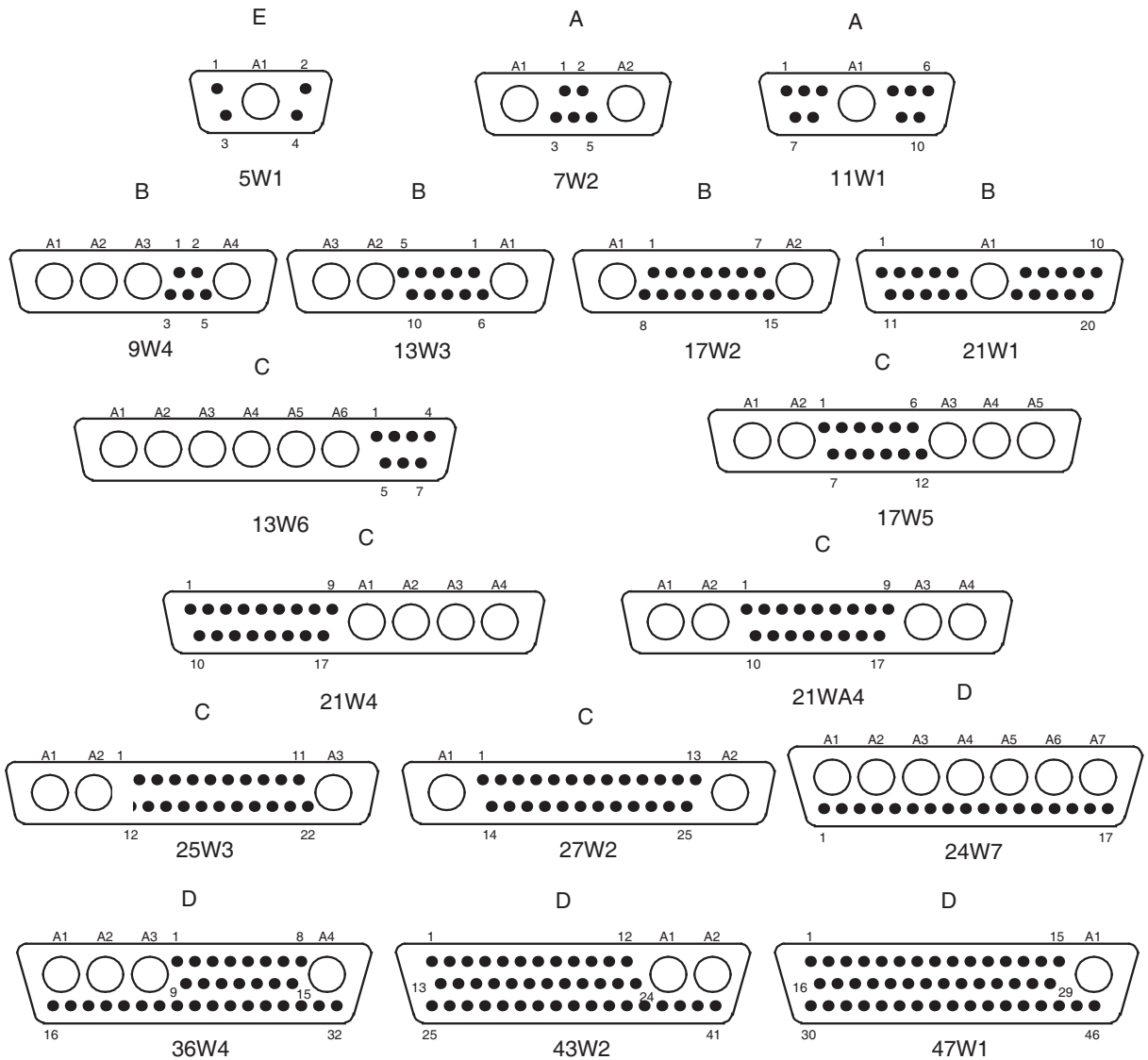

NOTES:

- Contact locations are in conformity with MIL-DTL-24308 specification sheets for standard signal contact arrangements and NASA/GSFC Specification S-311-P-10 for coaxial, power and mixed

- contact arrangements, and shall not be checked during procurement.
- 2. Both sides of the insert shall be marked with the minimum marking shown. Contact numbers are shown outside the inserts for readability.
- 3. See Para. 4.5 for definition of letters and numbers.
- 4. 3WK3 insulator with built-in keying (middle part recessed or protruding with respect to each side), to avoid mismounting (K = keyed).

FIGURE 2(c) REAR END
Gauge 20 Solder Bucket Contacts (CODE -)

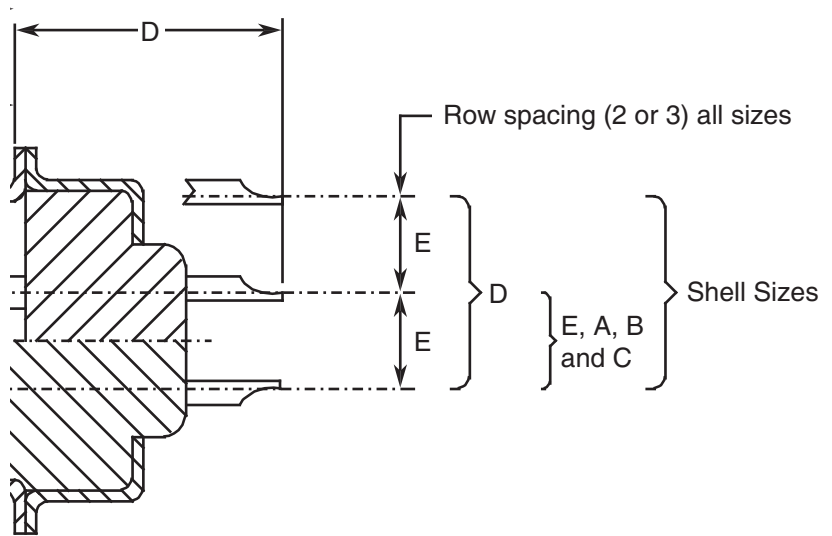

Pitch between contacts

Connector shell sizes E and A: 2.74.
 Connector shell sizes B, C and D: 2.76.

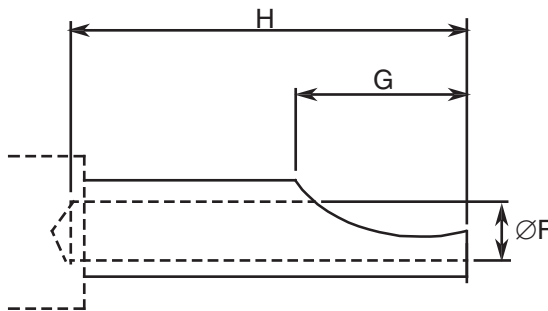

Symbol/Dim	\underline{D} (2) (3)	\underline{D} (4)	E (5)	$\underline{\text{ØF}}$	G	H
min.	-	-	2.77	1.1	1.4	2.4
max.	10.71	10.91	2.91	1.15	2.5	-

NOTES:

1. All dimensions are in mm.
2. Connectors equipped with female contacts all sizes.
3. Connectors equipped with male contacts sizes E and A.
4. Connectors equipped with male contacts sizes B, C, D.
5. Typical = 2.84.

Gauge 22 Solder Bucket Contacts (CODE -)

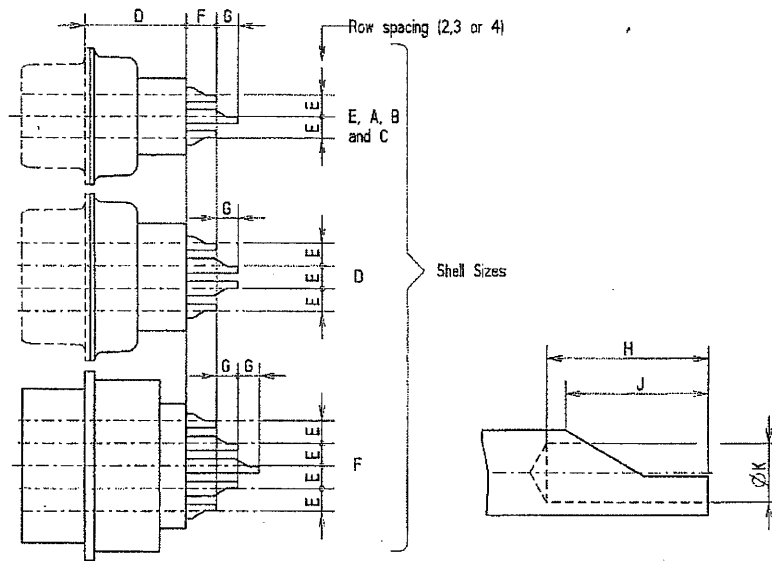

Pitch between contacts
 Connector shell sizes E, A and B: 2.29
 Connector shell sizes C, D and F: 2.41

Symbol/Dim	D		E		F	G	H	J	ØK
	(2) (3)	(4)	Sizes E, A, B, C (5)	Sizes D, F (6)					
min.	-	-	1.91	2.01	2.5	1.9	2.4	1.4	0.87
max.	11.21	11.41	2.05	2.15	3.1	2.1	-	2.5	0.93

NOTES:

1. All dimensions are in mm.
2. Connectors equipped with female contacts all sizes.
3. Connectors equipped with male contacts sizes E and A.
4. Connectors equipped with male contacts sizes B, C, D and F.
5. Typical = 1.98.
6. Typical = 2.08.

Gauge 20 Straight PCB Solder Contacts (Codes OL3 and Z)

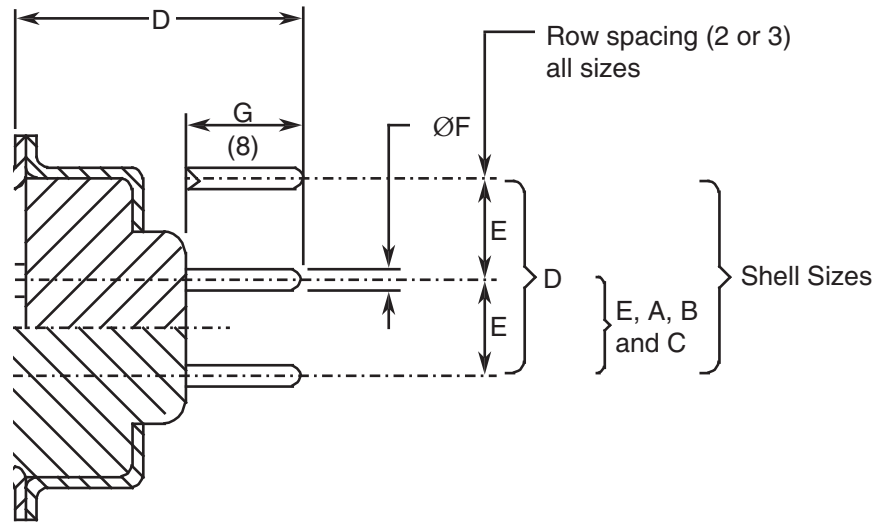

Pitch between contacts

Connector shell sizes E and A: 2.74.

Connector shell sizes B, C and D: 2.76.

Symbol/Dim	<u>D</u>	<u>D</u>	<u>E</u>	<u>ØF</u>		<u>G</u>
	(2) (3)	(4)	(5)	CODE OL3(6)	CODE Z (7)	(8)
min.	9.7	9.9	2.77	0.5	0.69	3.1
max.	11.5	11.7	2.91	0.65	0.84	5.3

NOTES:

1. All dimensions are in mm.
2. Connectors equipped with female contacts all sizes.
3. Connectors equipped with male contacts sizes E and A.
4. Connectors equipped with male contacts sizes B, C and D.
5. Typical = 2.84.
6. Typical = 0.60.
7. Typical = 0.76.
8. Dimension G is the length of the PCB tail extension of the contact.

Gauge 22 Straight PCB Solder Contacts (Code OL3)

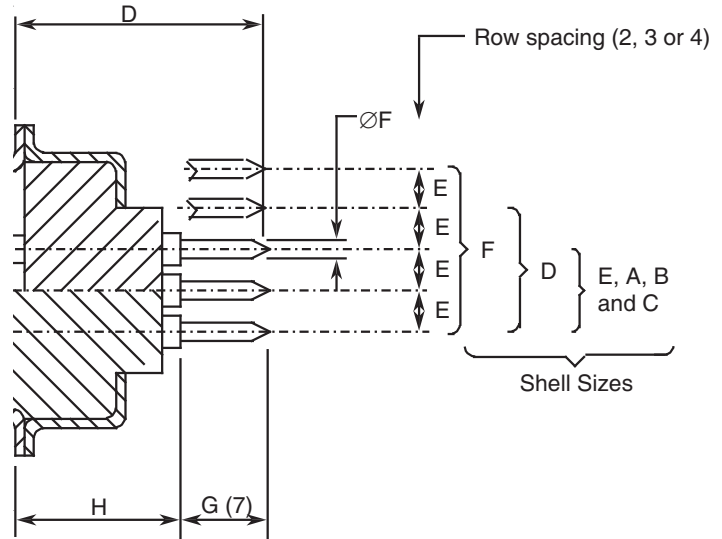

Pitch between contacts

Connector shell sizes E, A and B: 2.29.

Connector shell sizes C, D and F: 2.41.

Symbol/ Dim.	D			E		ØF	G (7)	H		
	(2)	(3)	(4)	Sizes E, A, B, C (5)	Sizes D, F (6)			(2)	(3)	(4)
min.	-	-	-	1.91	2.01	0.5	4.6	-	-	-
max.	16.17	16.01	16.21	2.05	2.15	0.65	4.8	11.37	11.21	11.41

NOTES:

1. All dimensions are in mm.
2. Connectors equipped with female contacts all sizes.
3. Connectors equipped with male contacts sizes E and A.
4. Connectors equipped with male contacts sizes B, C, D and F.
5. Typical = 1.98.
6. Typical = 2.08.
7. Dimension G is the length of the PCB tail extension of the contact.

Gauge 20 90° PCB Solder Contacts (Sizes E, A, B and C) (Codes 1A0N, 1B0N, 2A0N and 2B0N)

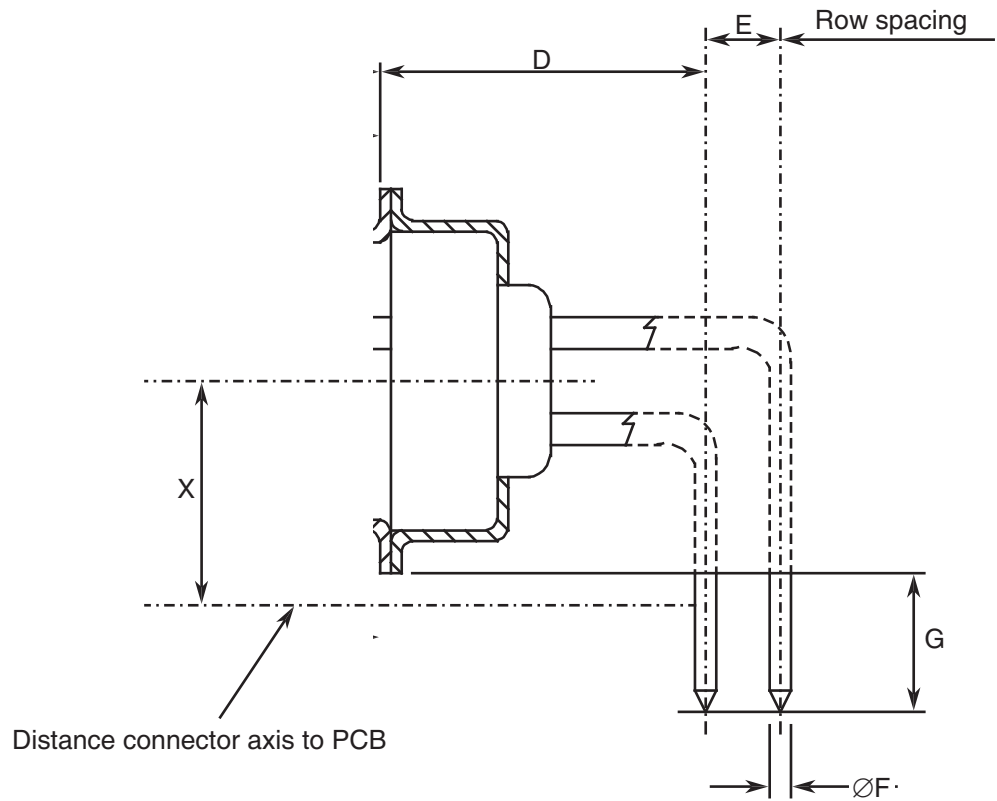

Pitch between contacts

Connector shell sizes E and A: 2.74.

Connector shell sizes B and C: 2.76.

Symbol/Dim	<u>D</u>		<u>E</u>		<u>ØF</u>		<u>G</u>	<u>X</u>
	(2) (3)	(4)	(*)A0N (5)	(*)B0N (6)	1A0N 1B0N (7)	2A0N 2B0N (8)		
min.	10.1	10.3	2.49	2.79	0.5	0.69	4.7	7.2
max.	10.3	10.5	2.59	2.89	0.65	0.84	5.3	7.5

NOTES:

1. All dimensions are in mm.
2. Connectors equipped with female contacts all sizes.
3. Connectors equipped with male contacts sizes E and A.
4. Connectors equipped with male contacts sizes B and C.
5. Typical = 2.54.
6. Typical = 2.84.
7. Typical = 0.60
8. Typical = 0.76.
9. Typical = 7.35.

Gauge 20 90° PCB Solder Contacts (Size D) (Codes 1A0N, 1B0N, 2A0N and 2B0N)

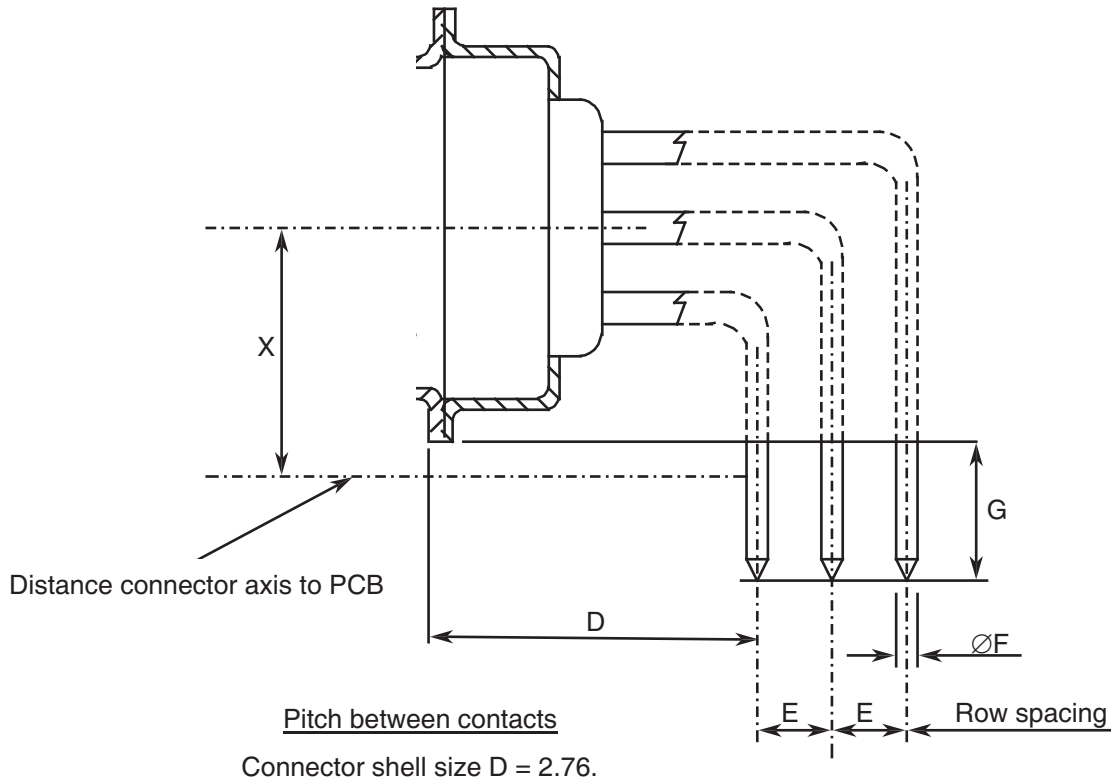

Symbol/Dim	D		E		ØF		G	X
	(2)	(3)	(*)A0N (4)	(*)B0N (5)	1A0N 1B0N (6)	2A0N 2B0N (7)		
min.	10.1	10.3	2.49	2.79	0.5	0.69	4.7	8.6
max.	10.3	10.5	2.59	2.89	0.65	0.84	5.3	8.8

NOTES:

1. All dimensions are in mm.
2. Connectors equipped with female contacts.
3. Connectors equipped with male contacts.
4. Typical = 2.54.
5. Typical = 2.84.
6. Typical = 0.60
7. Typical = 0.76.
8. Typical = 8.70

Gauge 22 90° PCB Solder Contacts (For Sizes E, A, B, C code 1C0N and Size D code 1D0N)

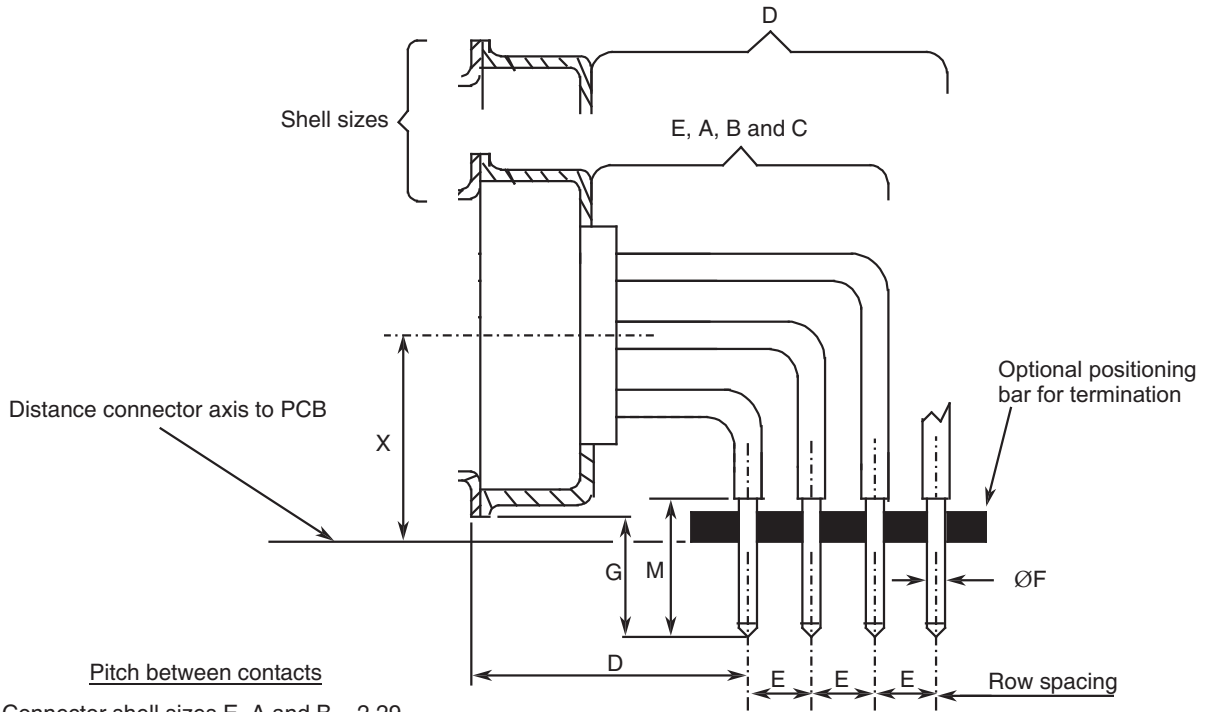

Pitch between contacts
 Connector shell sizes E, A and B = 2.29.
 Connector shell sizes C and D = 2.41.

Code	Symbol/ Dim.	<u>D</u>		<u>E</u>		<u>ØF</u>	<u>G</u>	<u>M</u>	<u>X</u>
		(2) (3)	(4)	1C0N (5)	1D0N (6)				
1C0N	min.	11.98	12.18	1.93	-	0.5	4.7	5.3	7.2
	max.	12.48	12.68	2.03	-	0.65	5.3	5.4	7.5
1D0N	min.	11.98	12.18	-	2.03	0.5	4.7	5.3	8.6
	max.	12.48	12.68	-	2.13	0.65	5.3	5.4	8.8

NOTES:

1. All dimensions are in mm.
2. Connectors equipped with female contacts all sizes.
3. Connectors equipped with male contacts sizes E and A.
4. Connectors equipped with male contacts sizes B, C and D.
5. Typical = 1.98.
6. Typical = 2.08
7. For sizes E, A, B and C, Typical = 7.35.
8. For size D, Typical = 8.70.

Gauge 22 90° PCB Solder Contacts (Size F code 1D0N)

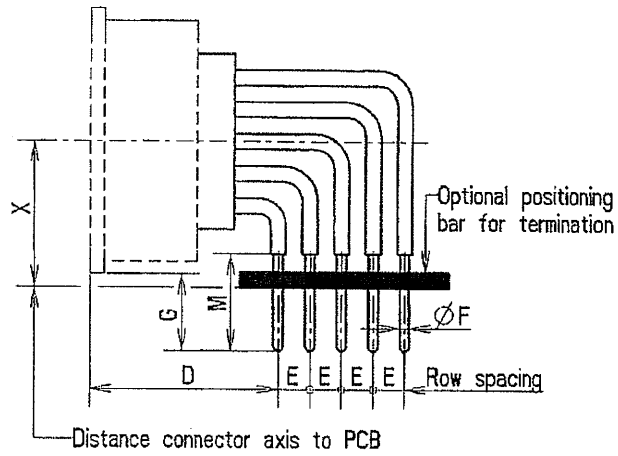

Pitch between contacts
Connector shell size F = 2.41

Symbol/Dim.	<u>D</u>	E (2)	ØF	G	M	X (3)
min.	12.18	2.03	0.5	4.7	5.3	8.6
max.	12.68	2.13	0.65	5.3	5.4	8.8

NOTES:

1. All dimensions are in mm.
2. Typical = 2.08.
3. Typical = 8.70.

**Gauge 20 90° PCB Solder Contacts with 90° Bracket and Screw Locks (Sizes E, A, B and C)
(Codes 1A7N, 1A9N, 1B7N, 1B9N, 2A7N, 2A9N, 2B7N and 2B9N)**

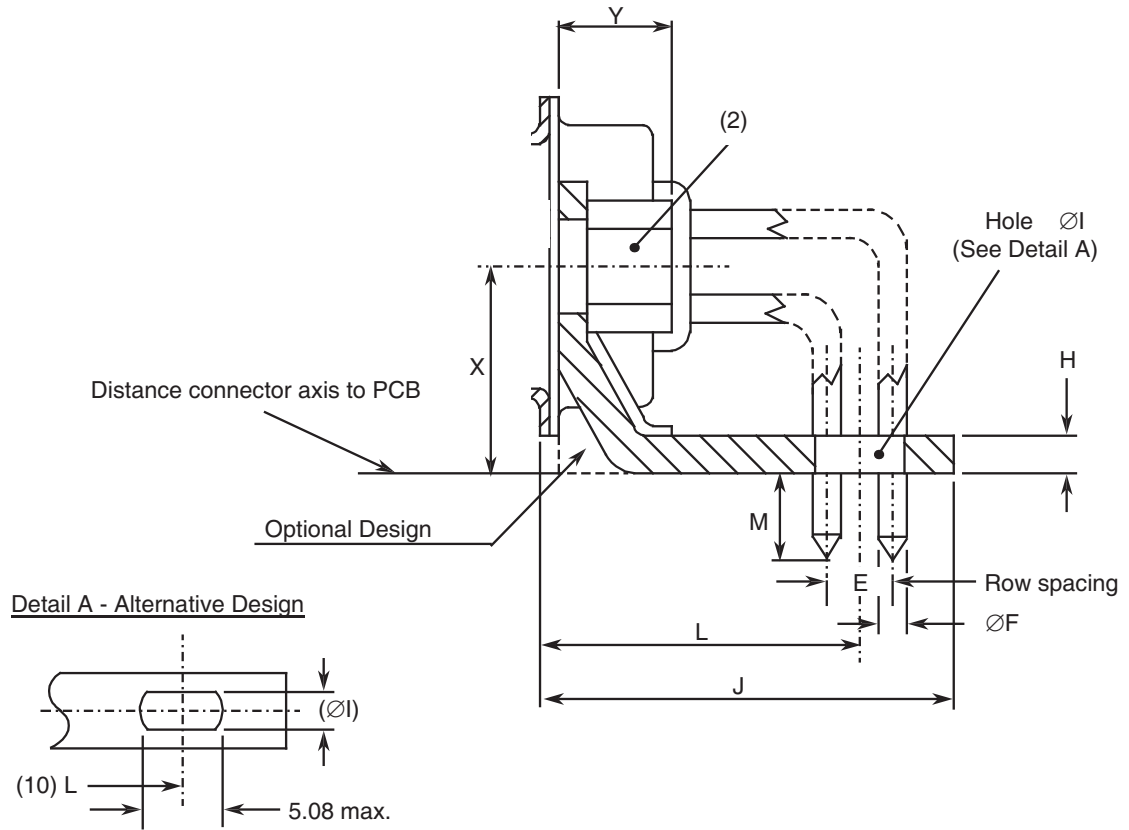

Symbol/ Dim.	E		ØF		H	ØI	J		L				M	X (9)	Y
	(*)A7N (*)A9N (3)	(*)B7N (*)B9N (4)	1(*)7N 1(*)9N (5)	2(*)7N 2(*)9N (6)			(7)	(8)	(7)		(8)				
									(*)A7N (*)A9N	(*)B7N (*)B9N	(*)A7N (*)A9N	(*)B7N (*)B9N			
min.	2.49	2.79	0.5	0.69	1	3.12	-	-	11.37	11.52	11.57	11.72	3.6	7.2	-
max.	2.59	2.89	0.65	0.84	3.2	3.32	15.6	15.8	11.57	11.72	11.77	11.92	4.4	7.5	7

NOTES:

- All dimensions are in mm.
- Codes (*)A7N and (*)B7N: Nut 4-40.
Codes (*)A9N and (*)B9N: Nut M3.
- Typical = 2.54.
- Typical = 2.84.
- Typical = 0.60.
- Typical = 0.76.
- Connectors equipped with female contacts all sizes and connectors equipped with male contacts sizes E and A.
- Connectors equipped with male contacts sizes B and C.
- Typical = 7.35.
- This alternative design takes into account the different possible values of L.

Gauge 20 90° PCB Solder Contacts with 90° Bracket and Screw Locks (Size D)
(Codes 1A7N, 1A9N, 1B7N, 1B9N, 2A7N, 2A9N, 2B7N and 2B9N)

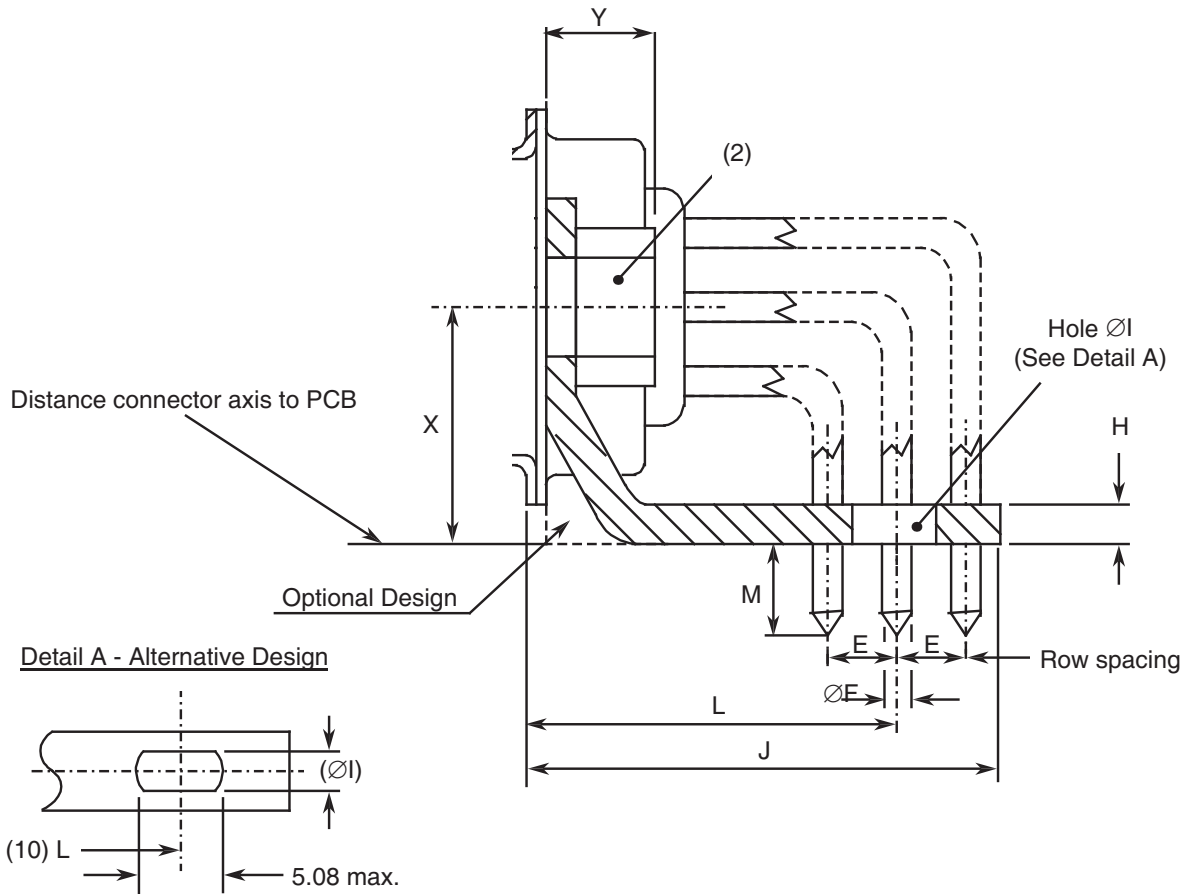

Symbol/ Dim.	E		ØF		H	ØI	J		L				M	X	Y
	(*)A7N (*)A9N (3)	(*)B7N (*)B9N (4)	1(*)7N 1(*)9N (5)	2(*)7N 2(*)9N (6)			(7)	(8)	(7)		(8)				
									(*)A7N (*)A9N	(*)B7N (*)B9N	(*)A7N (*)A9N	(*)B7N (*)B9N			
min.	2.49	2.79	0.5	0.69	1	3.12	-	-	12.64	12.94	12.84	13.14	3.6	8.6	-
max.	2.59	2.89	0.65	0.84	3.2	3.32	17.5	17.7	12.84	13.14	13.04	13.34	4.4	8.8	7

NOTES:

1. All dimensions are in mm.
2. Codes (*)A7N and (*)B7N: Nut 4-40.
Codes (*)A9N and (*)B9N: Nut M3.
3. Typical = 2.54.
4. Typical = 2.84.
5. Typical = 0.60.
6. Typical = 0.76.
7. Connectors equipped with female contacts.
8. Connectors equipped with male contacts.
9. Typical = 8.70.
10. This alternative design takes into account the different possible values of L.

**Gauge 22 90° PCB Solder Contacts with 90° Bracket and Screw Locks (Sizes E, A, B and C)
(Codes 1C7N and 1C9N)**

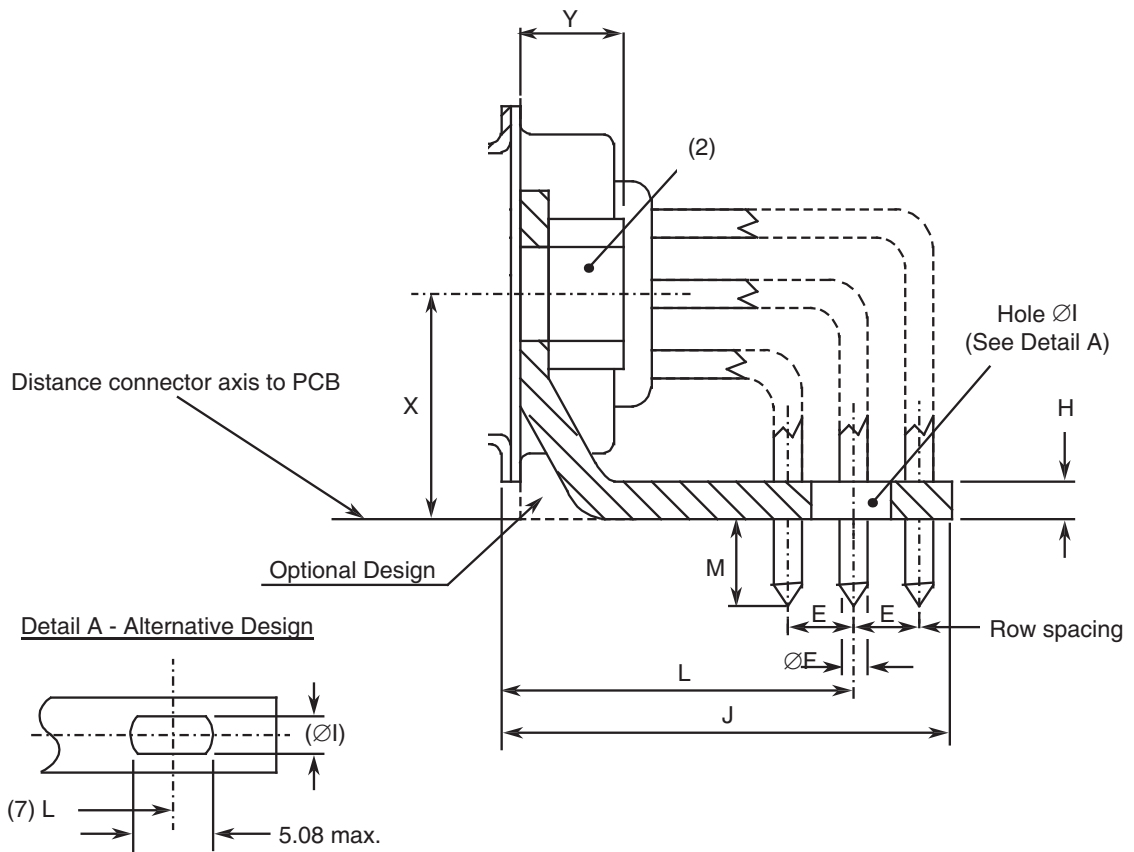

Symbol/ Dim.	E (3)	ØF	ØI	H	J		L		M	X (6)	Y
					(4)	(5)	1C7N 1C9N (4)	1C7N 1C9N (5)			
min.	1.93	0.5	3.12	1	-	-	14.11	14.31	3.6	7.2	-
max.	2.03	0.65	3.32	3.2	18.3	18.5	14.31	14.51	4.4	7.5	7

NOTES:

1. All dimensions are in mm.
2. Code 1C7N: Nut 4-40.
Code 1C9N: Nut M3.
3. Typical = 1.98.
4. Connectors equipped with female contacts all sizes and connectors equipped with male contacts sizes E and A.
5. Connectors equipped with male contacts sizes B and C.
6. Typical = 7.35
7. This alternative design takes into account the different possible values of L.

**Gauge 22 90° PCB Solder Contacts with 90° Bracket and Screw Locks (Size D)
(Codes 1D7N and 1D9N)**

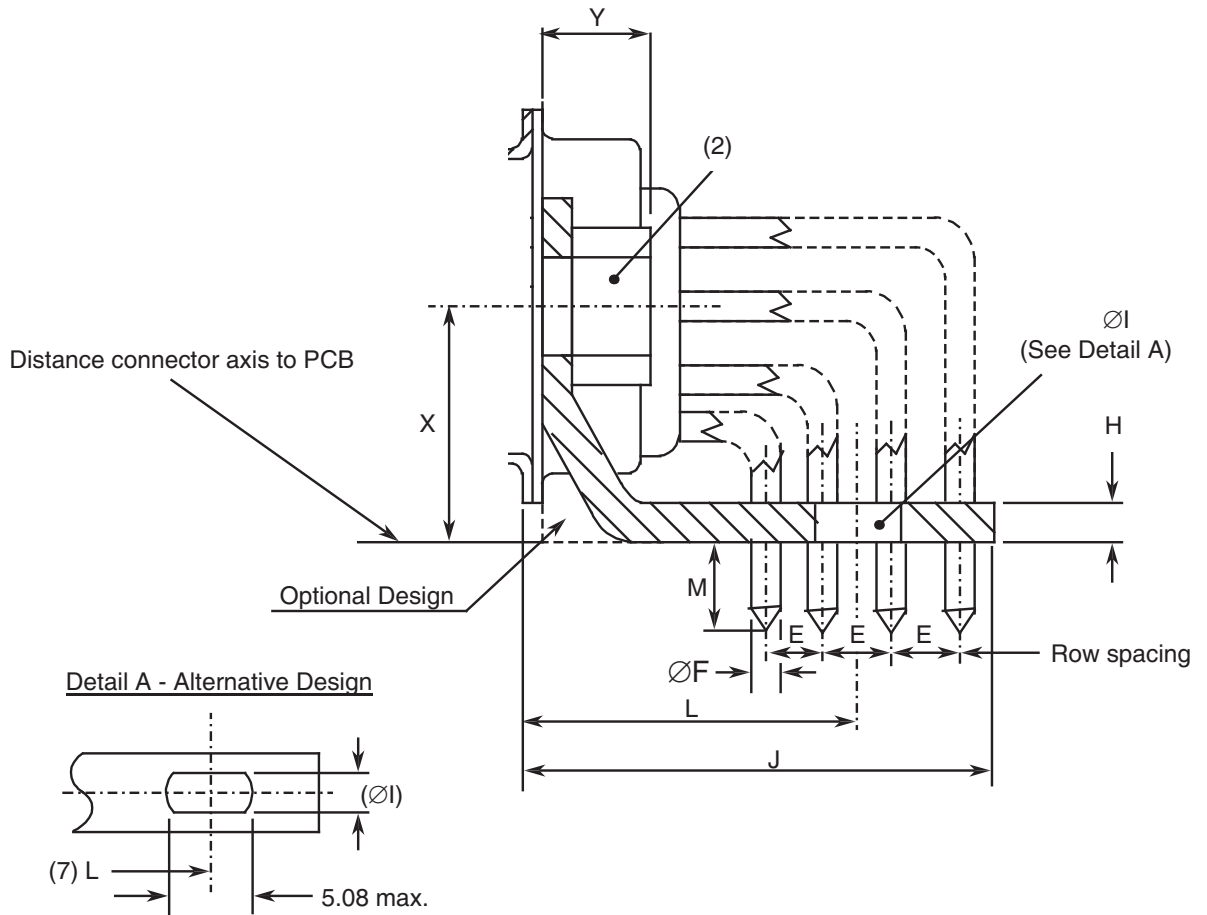

Symbol/ Dim.	E (3)	ØF	ØI	H	J		L		M	X (6)	Y
					(4)	(5)	1C7N 1C9N	1C7N 1C9N			
min.	2.03	0.5	3.12	1	-	-	15.25	15.45	3.6	8.6	-
max.	2.13	0.65	3.32	3.2	20.5	20.7	15.45	15.65	4.4	8.8	7

NOTES:

1. All dimensions are in mm.
2. Code 1D7N: Nut 4-40.
Code 1D9N: Nut M3.
3. Typical = 2.08.
4. Connectors equipped with female contacts.
5. Connectors equipped with male contacts.
6. Typical = 8.70.
7. This alternative design takes into account the different possible values of L.

**Gauge 22 90° PCB Solder Contacts with 90° Bracket and Screw Locks (Size F)
(Code 1D7N and 1D9N)**

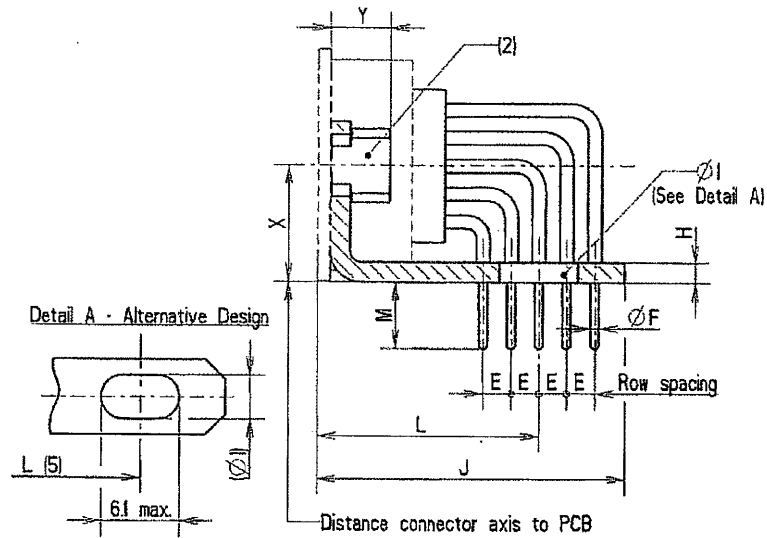

Symbol /Dim.	E	ØF	ØI	H	J	L	M	X	Y
	(3)							(4)	
min.	2.03	0.5	3.12	1	-	16.15	4.6	8.6	-
max.	2.13	0.65	3.32	3.2	23.5	16.85	5.4	8.8	7

NOTES:

1. All dimensions are in mm.
2. Code 1D7N: Nut 4-40.
Code 1D9N: Nut M3.
3. Typical = 2.08.
4. Typical = 8.70.
5. This alternative design takes into account the different possible values of L.

Gauge 20 90° PCB Solder Contacts (Sizes E, A, B and C) (Code P)

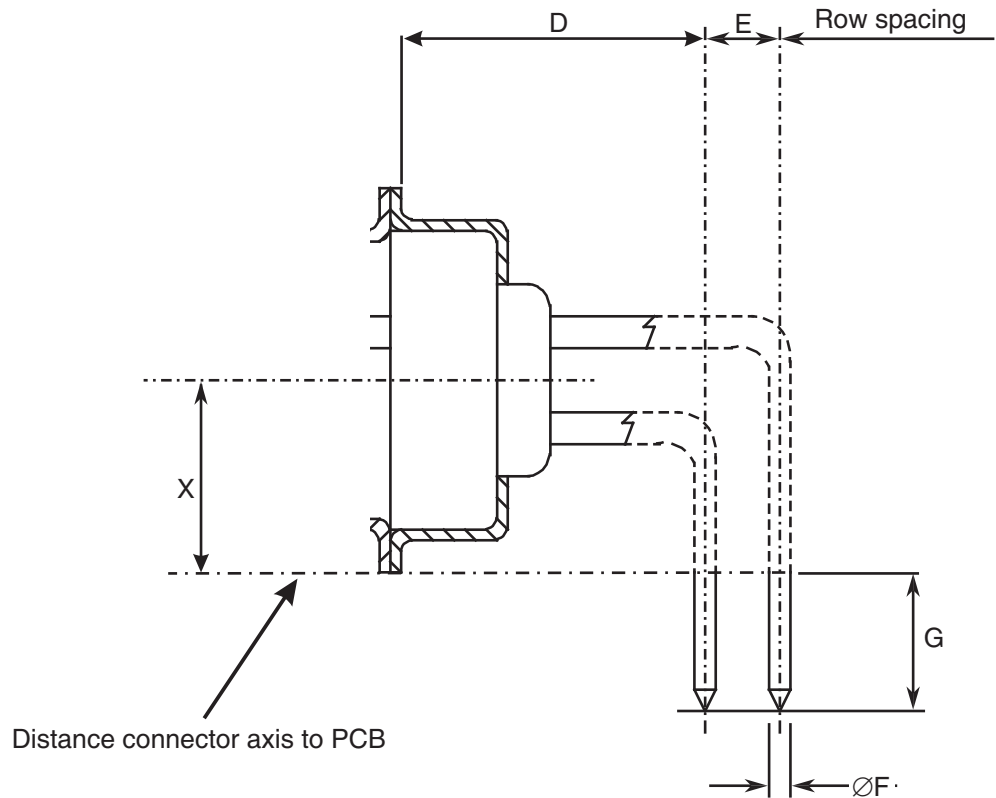

Pitch between contacts

Connector shell sizes E and A: 2.74.
Connector shell sizes B and C: 2.76.

Symbol/Dim	<u>D</u> (2)	<u>E</u> (3)	<u>ØF</u> (4)	<u>G</u>	<u>X</u> (5)
min.	6.94	2.79	0.69	3.9	6.2
max.	7.44	2.89	0.84	4.7	6.5

NOTES:

1. All dimensions are in mm.
2. Typical = 7.19.
3. Typical = 2.84.
4. Typical = 0.76.
5. Typical = 6.35.

Gauge 20 90° PCB Solder Contacts (Size D) (Code P)

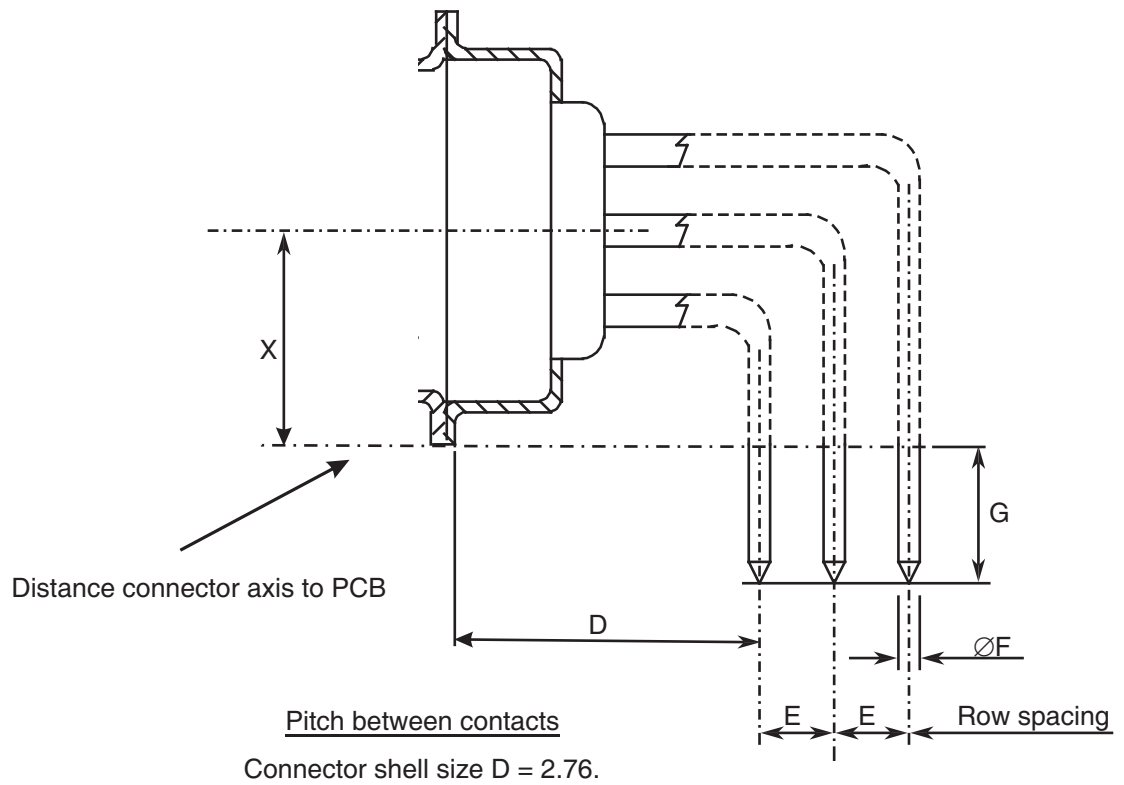

Symbol/Dim	<u>D</u> (2)	<u>E</u> (3)	<u>ØF</u> (4)	<u>G</u>	<u>X</u> (5)
min.	6.94	2.79	0.69	3.9	7.6
max.	7.44	2.89	0.84	4.7	7.9

NOTES:

1. All dimensions are in mm.
2. Typical = 7.19.
3. Typical = 2.84.
4. Typical = 0.76.
5. Typical = 6.35.

**Gauge 20 90° PCB Solder Contacts with 90° Bracket and Screw Locks (Sizes E, A, B and C)
(Codes L7, L9)**

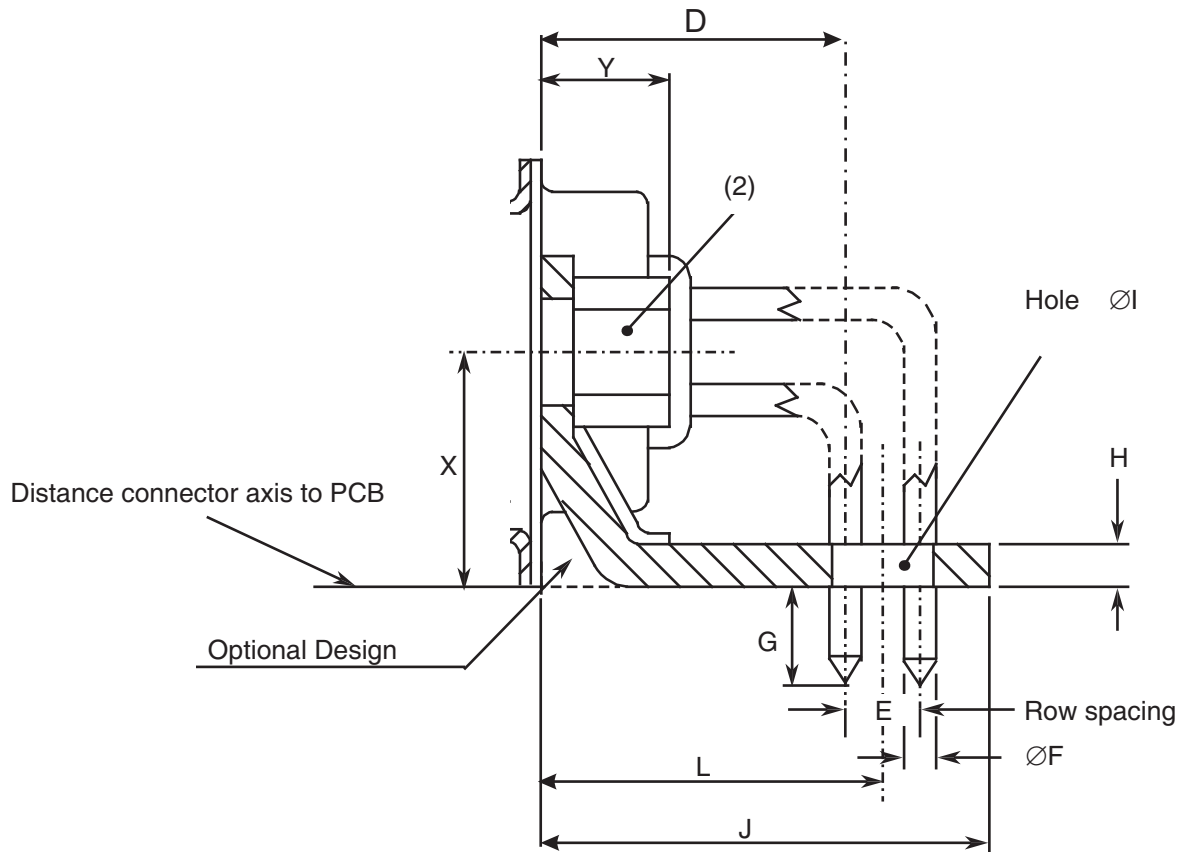

Pitch between contacts

Connector shell sizes E and A: 2.74.
Connector shell sizes B and C: 2.76.

Symbol/Dim	<u>D</u> (3)	E (4)	<u>ØF</u> (5)	<u>G</u>	H	I	J	<u>L</u>	X (6)	Y
min.	6.94	2.79	0.69	3.9	1	3.12	11.4	8.5	6.2	-
max.	7.44	2.89	0.84	4.7	3.2	3.32	11.8	8.7	6.5	7

NOTES:

1. All dimensions are in mm.
2. Code L7: Nut 4-40.
Code L9: Nut M3.
3. Typical = 7.19.
4. Typical = 2.84.
5. Typical = 0.76.
6. Typical = 6.35.

Gauge 20 90° PCB Solder Contacts with 90° Bracket and Screw Locks (Size D) (Codes L7, L9)

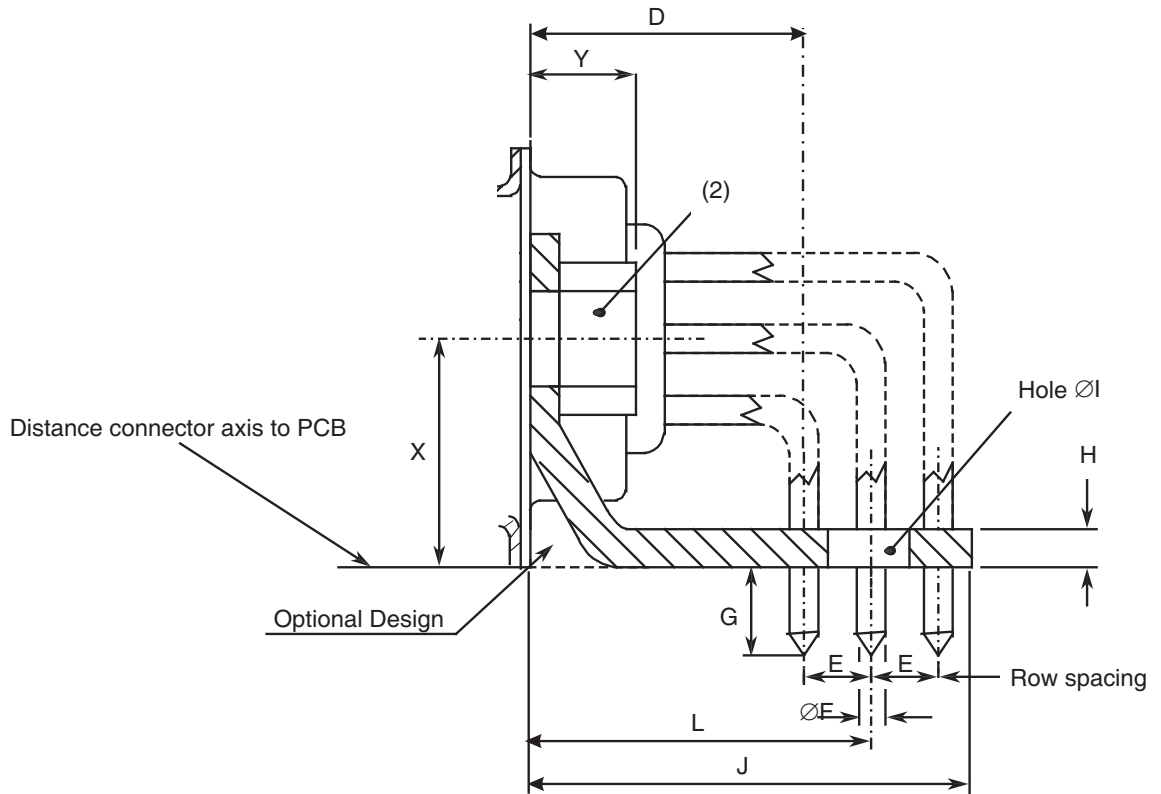

Pitch between contacts
Connector shell size D = 2.76.

Symbol/Dim	<u>D</u> (3)	E (4)	<u>ØE</u> (5)	<u>G</u>	H	I	J	<u>L</u>	X (6)	Y
min.	6.94	2.79	0.69	3.9	1	3.12	11.4	8.5	6.2	-
max.	7.44	2.89	0.84	4.7	3.2	3.32	11.8	8.7	6.5	7

NOTES:

1. All dimensions are in mm.
2. Code L7: Nut 4-40.
Code L9: Nut M3.
3. Typical = 7.19.
4. Typical = 2.84.
5. Typical = 0.76.
6. Typical = 7.75.

Gauge 20 Wire-Wrap Contacts (Code F179A)

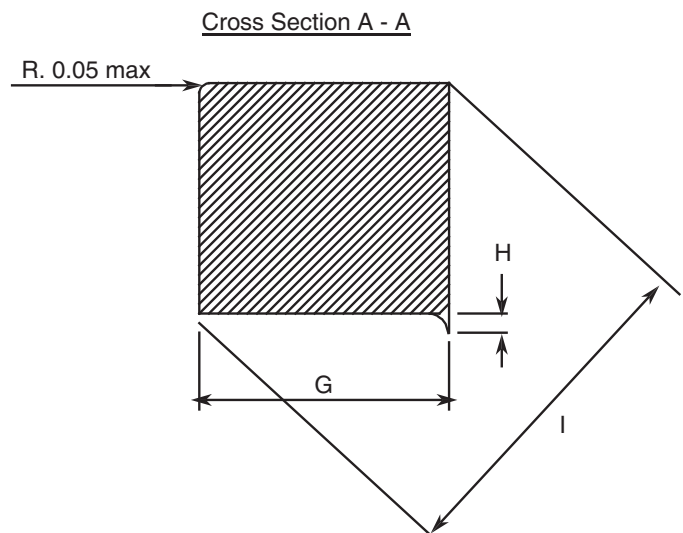
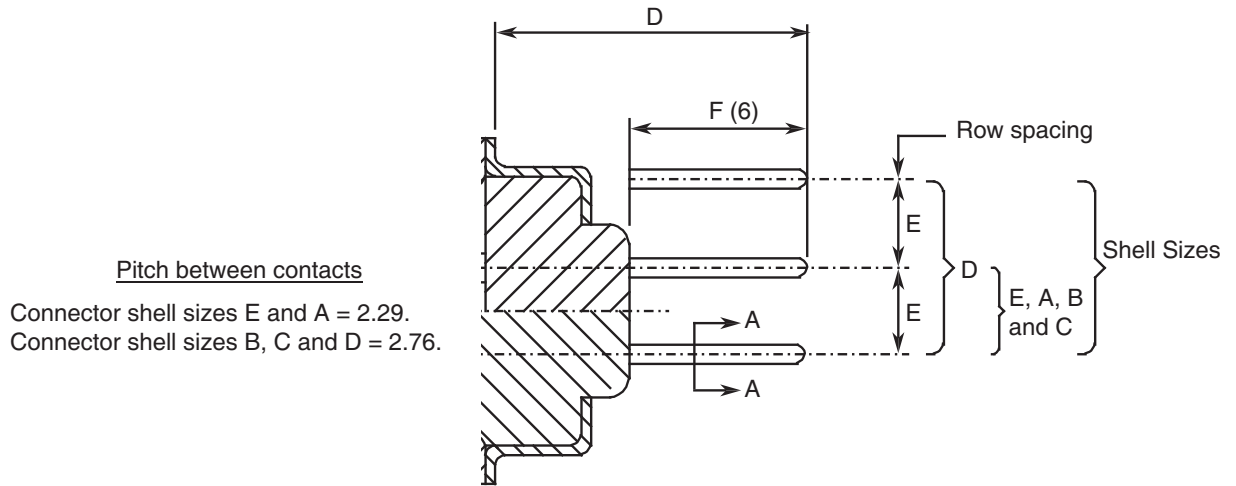

Symbol/ Dim.	D		E (5)	F (6)	G	H	I
	(2) (3)	(4)					
min.	-	-	2.77	12.6	0.59	-	0.787
max.	20.1	20.3	2.91	12.8	0.61	0.02	0.864

NOTES:

1. All dimensions are in mm.
2. Connectors equipped with female contacts all sizes.
3. Connectors equipped with male contacts sizes E and A.
4. Connectors equipped with male contacts sizes B, C and D.
5. Typical = 2.84.
6. Dimension F is the length of the square part of the contact.

Power and Coaxial Contacts (Code -)
Straight Coaxial Contacts

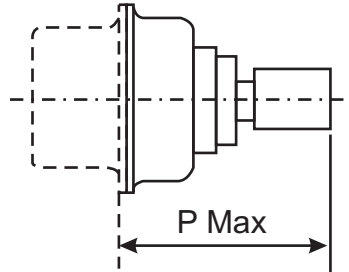

Symbol	Connectors equipped with Variant Number per 3401/004			
	3401/004 Variants 01-02-05-06-11-12-15-16		3401/004 Variants 09-10-19-20	
P	19.6 (2) (3)	19.8 (4)	22.3 (2) (3)	22.5 (4)

90° Coaxial Contacts

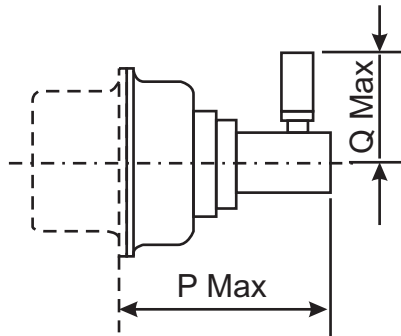

Symbol	Connectors equipped with 3401/004 Variants 03-04-07-08-13-14-17-18	
P	14.3 (2) (3)	14.5 (4)
Q	12.5	

Straight Coaxial PCB Contacts

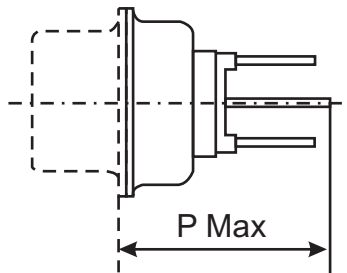

Symbol	Connectors equipped with 3401/004 Variants 21-22	
P	13.8 (2) (3)	14 (4)

90° Coaxial PCB Contacts

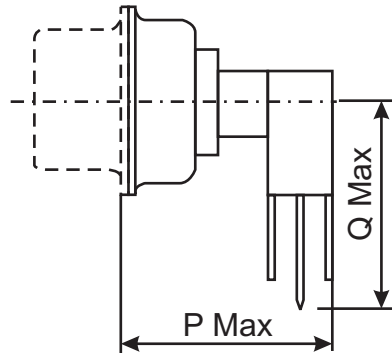

Symbol	Connectors equipped with 3401/004 Variants 23-24	
P	15.8 (2) (3)	16 (4)
Q	13	

Straight Power Solder Contact

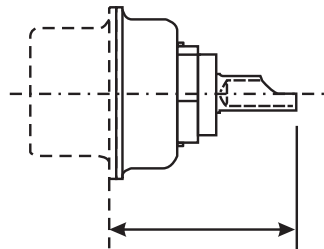

3401/001 connectors equipped with contact Variants 01 through 06 of 3401/040

17.7 Max. (2) (3)
17.9 Max. (4)

Straight Power Crimp Contact

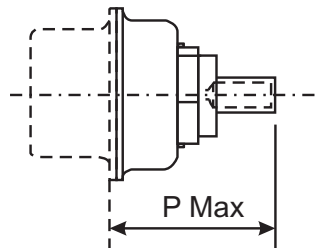

3401/001 connectors equipped with contact Variants 07 through 12 of 3401/040

19.8 Max. (2) (3)
20 Max. (4)

Straight Power PCB Contact

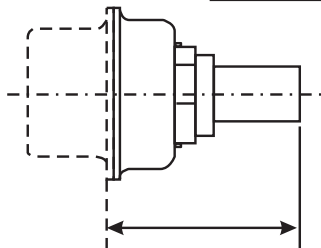

3401/001 connectors equipped with contact Variants 13 and 14 of 3401/040

14.8 Max. (2) (3)
15 Max. (4)

90° Power PCB Contact

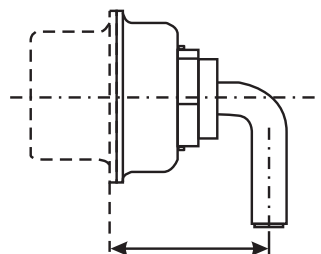

3401/001 connectors equipped with contact Variants 15 and 16 of 3401/040

12.8 Max. (2) (3)
13 Max. (4)

NOTES:

1. All dimensions are in mm.
2. Connectors equipped with female contacts all sizes.
3. Connectors equipped with male contacts sizes E and A.
4. Connectors equipped with male contacts sizes B, C and D.

4. REQUIREMENTS**4.1 GENERAL**

The complete requirements for procurement of the connectors specified herein are stated in this specification and ESCC Generic Specification No. 3401. Deviations from the Generic Specification, applicable to this specification only, are listed in Para. 4.2.

Deviations from the applicable Generic Specification and this Detail Specification, formally agreed with specific Manufacturers on the basis that the alternative requirements are equivalent to the ESCC requirements and do not affect the components' reliability, are listed in the appendices attached to this specification.

4.2 DEVIATIONS FROM GENERIC SPECIFICATION**4.2.1 Deviations from Special In-Process Controls**

None.

4.2.2 Deviations from Final Production Tests (Chart II)

- (a) Para. 9.9, Seal Test: Not applicable.

4.2.3 Deviations from Burn-in and Electrical Measurements (Chart III)

Not applicable.

4.2.4 Deviations from Qualification Tests (Chart IV)

- (a) Para. 9.1.1.4, Mated Shell Conductivity: Not applicable.
(b) Para. 9.9, Seal Test: Not applicable.
(c) Para. 9.2.4, Jackscrew Retention, Not applicable.
(d) Para. 9.27, Maintenance Aging: Not applicable to gauge 20 and 22 contacts.

4.2.5 Deviations from Lot Acceptance Tests (Chart V)

- (a) Para. 9.1.1.4, Mated Shell Conductivity: Not applicable.
(b) Para. 9.9, Seal Test: Not applicable.

4.3 MECHANICAL REQUIREMENTS

4.3.1 Dimension Check

The dimensions of the connectors specified herein shall be verified in accordance with the requirements set out in Para. 9.6 of ESCC Generic Specification 3401 and shall conform to those shown in Figure 2 of this specification. Only the underlined dimensions shall be checked during procurement.

4.3.2 Weight

The maximum weight of the connectors specified herein, with contacts, shall be as specified in Table 1(a).

4.3.3 Contact Capability

For the purpose of this test, the pick-up and drop weights shall be as follows.

CONTACTS	MEASUREMENTS	PICK-UP WEIGHT	DROP WEIGHT
Gauge 20	Weight (g)	28.35	226.8
	Pin diameter (mm)	0.99 to 0.993	1.039 to 1.04
	Insertion depth (mm)	4.0	4.0
Gauge 22	Weight (g)	19.84	226.8
	Pin diameter (mm)	0.749 to 0.751	0.773 to 0.775
	Insertion depth (mm)	4.0	4.0

See ESCC Detail Specifications Nos. 3401/004 and 3401/040 for coaxial and power contacts.

4.3.4 Contact Retention (in insert)

The contact retention force of gauge 20 and 22 contacts within the insert shall be 40N.

See ESCC Detail Specification Nos. 3401/004 and 3401/040 for coaxial and power contacts.

4.3.5 Mating and Unmating Forces

The forces applied for mating and unmating of the connectors shall conform to the values specified in Table 1(a).

4.3.6 Insert Retention (in Shell)

Connector inserts shall withstand a pressure of 42.8N/cm² without being dislodged from the shell.

4.3.7 Jackscrew Retention

Not applicable

4.3.8 Contact Insertion and Withdrawal Forces

See ESCC Detail Specification Nos. 3401/004 & 3401/040 for coaxial and power contacts. Not applicable to other contact types.

4.3.9 Engagement and Separation Forces

The engagement and separation forces of the female contacts shall be tested with the applicable test pin and shall not exceed the values of the table hereunder.

CONTACTS	MEASUREMENTS	DIAMETER (mm)		ENGAGEMENT MAX (N)	SEPARATION (N)	
		MIN	MAX		MIN	MAX
Gauge 20	Max Ø Test Pin	1.039	1.04	3.33	-	2.22
	Min Ø Test Pin	0.99	0.993	-	0.28	-
Gauge 22	Max Ø Test Pin	0.773	0.775	3.33	-	2.22
	Min Ø Test Pin	0.749	0.751	-	0.2	-

See ESCC Detail Specifications Nos. 3401/004 and 3401/040 for coaxial and power contacts.

4.3.10 Oversize Pin Exclusion

The diameter of the test pin and the force applied to it shall be as follows:

CONTACTS	TEST PIN DIAMETER (mm)		FORCE (N) MAX
	MIN	MAX	
Gauge 20	1.166	1.17	3.33
Gauge 22	0.905	0.907	2.43

See ESCC Detail Specifications Nos. 3401/004 and 3401/040 for coaxial and power contacts.

4.3.11 Probe Damage

The probe diameter and the moment at the end of the probe shall be as follows.

CONTACTS	PROBE DIAMETER (mm)		MOMENT (N.cm)
	MIN	MAX	
Gauge 20	1.007	1.033	5.65
Gauge 22	0.749	0.774	1.30

See ESCC Detail Specification Nos. 3401/004 and 3401/040 for coaxial and power contacts.

4.3.12 Solderability

Size A soldering iron shall be used.

See ESCC Detail Specification Nos. 3401/004 and 3401/040 for coaxial and power contacts.

4.4 MATERIAL AND FINISHES

The materials and finishes shall be as specified herein. Where a definite material is not specified, a material which will enable the connectors specified herein to meet the performance requirements of this specification shall be used. Acceptance or approval of any constituent material does not guarantee acceptance of the finished product.

4.4.1 Shells

Shells of shell sizes E, A, B, C and D shall be made of brass. The plating shall be 0.7µm minimum of gold over 1µm minimum of copper.

Shells of shell size F shall be made of aluminium alloy. The plating shall be either 25.4µm minimum of electroless nickel (Modification Code A174) or 0.7µm minimum of gold with 25.4µm minimum electroless nickel underplating (Modification Code FR172).

4.4.2 Inserts

Inserts shall be made of glass-fibre filled diallylphthalate resin or a suitable thermoplastic material.

4.4.3 Contacts

The contact body shall be made of copper alloy with an underplate of 1µm minimum of copper, gold plated with 1.27µm minimum of gold.

The female contact spring element shall be made of copper alloy with an underplate of 1µm minimum of nickel or copper, gold plated with 1.27µm minimum of gold.

4.4.4 Contact Retaining Clip

Not applicable to gauge 20 and 22 contacts.

See ESCC Detail Specification Nos. 3401/004 and 3401/040 for coaxial and power contacts.

4.4.5 Guiding and Locking Devices

As specified in ESCC Detail Specification Nos. 3401/022, 3401/072 and 3401/085.

4.4.6 Magnetism Level

The allowable value of magnetism shall not exceed that specified for the relevant level (see Para. 4.5.4.7). Only magnetism levels NMC and NMD are verified.

4.5 MARKING

4.5.1 General

The marking of all components delivered to this specification shall be in accordance with the requirements of ESCC Basic Specification No. 21700 and the following paragraphs. When the component is too small to accommodate all of the marking specified, as much as space permits shall be marked and the marking information, in full, shall accompany the component in its primary package.

The information to be marked and the order of precedence, shall be as follows:

- (a) Contact Position.
- (b) The ESCC Component Number.
- (c) Characteristics.
- (d) Traceability information.

4.5.2 Contact Position

Contact position shall be marked on the inserts in accordance with Figure 2(b)

4.5.3 The ESCC Component Number

The ESCC Component Number shall be constituted and marked as follows:

Detail Specification Number: 3401001
 Type Variant (see Table 1(a)): 01
 Testing Level: B

4.5.4 Characteristics

The characteristics to be marked in the following order of precedence are:

- (a) Series.
- (b) Shell size.
- (c) Insert type.
- (d) Mounting.
- (e) Contact arrangement.
- (f) Type of contact.
- (g) Magnetism level.
- (h) Contact termination code.
- (i) Modification code.

The information shall be constituted and marked as follows:

example: DAMY7W2SNMCOL3

Series	D
Shell size	A
Insert Type	M
Mounting	Y
Contact arrangement	7W2
Type of contact	S
Magnetism Level	NMC
Contact termination code (Table 1(a))	OL3
Modification Code	(blank)

4.5.4.1 *Series*

This connector series shall be designated by the letter “D”.

4.5.4.2 *Shell Size*

The shell size shall be indicated by the letters specified hereafter.

Code	E	A	B	C	D	F
------	---	---	---	---	---	---

4.5.4.3 *Insert Type*

This insert type is defined by the letter “M”.

4.5.4.4 *Mounting*

The letter “E” indicates a captive nut.

The letter “Y” indicates a floating mount.

If the letter has fixed mounting holes, these letters shall be omitted.

4.5.4.5 *Contact Arrangement*

The number of contacts shall be as shown in Figure 2(b) and contact arrangements shall be indicated by the codes specified hereafter.

CODE	SHELL SIZE	NUMBER OF CONTACTS GAUGE 20	NUMBER OF CONTACTS GAUGE 22	NUMBER OF COAXIAL OR POWER CONTACT CAVITIES (Note 1)
9	E	9	0	0
5W1	E	4	0	1
15	A	15	0	0
15	E	0	15	0
3W3	A	0	0	3
3WK3	A	0	0	3 (2)
7W2	A	5	0	2
11W1	A	10	0	1
25	B	25	0	0
26	A	0	26	0
5W5	B	0	0	5
9W4	B	5	0	4
13W3	B	10	0	3
17W2	B	15	0	2
21W1	B	20	0	1
37	C	37	0	0
8W8	C	0	0	8
13W6	C	7	0	6
17W5	C	12	0	5
21WA4	C	17	0	4 (3)
21W4	C	17	0	4 (3)
25W3	C	22	0	3
27W2	C	25	0	2

CODE	SHELL SIZE	NUMBER OF CONTACTS GAUGE 20	NUMBER OF CONTACTS GAUGE 22	NUMBER OF COAXIAL OR POWER CONTACT CAVITIES (Note 1)
44	B	0	44	0
50	D	50	0	0
24W7	D	17	0	7
36W4	D	32	0	4
43W2	D	41	0	2
47W1	D	46	0	1
62	C	0	62	0
78	D	0	78	0
104	F	0	104	0

NOTES:

- For connectors with contact arrangements that include coaxial or power contact cavities, the coaxial or power contacts shall be ordered separately in accordance with ESCC Detail Specification Nos. 3401/004 and 3401/040 respectively.
Coaxial and power contacts must be from the same Manufacturer as the connector in which they are mounted and this shall be verified prior to assembly.
- 2 male plus 1 female or 2 female plus 1 male (see Para. 4.5.4.6).
- See Figure 2(b) for physical differences.

4.5.4.6 Type of Contact

The contact types shall be indicated by the following code letters.

CODE LETTER	CONTACT TYPE
P	Male
S	Female

For the 3WK3 arrangement, the contact cavities A1 and A3 shall determine the code letter to be used.

4.5.4.7 Magnetism Level

The following codes shall be used for magnetism level.

CODE	DEFINITION
NMB	Magnetism Level: ≤ 200 gamma (1)
NMC	Magnetism Level: ≤ 20 gamma
NMD	Magnetism Level: ≤ 2 gamma

NOTES:

- Guaranteed, but not measured.

4.5.4.8 Contact Termination Code

Contact terminations shall be indicated as given in Table 1(a), Contact Types. For mixed contact arrangements, (see Figure 2(b)), the gauge 20 contact type shall determine the contact code used.

4.5.4.9 Modification Code

The modification code for the finish of shell size F (aluminium alloy) shall be:

- A174 for the electroless nickel finish.
- FR172 for the gold over electroless nickel finish.

The modification code shall be omitted for shell sizes E, A, B, C and D.

4.5.5 Traceability Information

Traceability information shall be marked in accordance with the requirements of ESCC Basic Specification No. 21700.

4.6 ELECTRICAL MEASUREMENTS

4.6.1 Electrical Measurements at Room Temperature

The parameters to be measured in respect of electrical characteristics are scheduled in Table 2. Unless otherwise specified, these measurements shall be performed at $T_{amb} = +22 \pm 3^{\circ}C$.

4.6.2 Electrical Measurements at High and Low Temperatures

Not applicable.

Table 2 - ELECTRICAL MEASUREMENTS AT ROOM TEMPERATURE

No.	Characteristic	Symbol	ESCC 3401 Test Method	Test Condition	Limits		Unit
					Min	Max	
1	Insulation Resistance	R_I	Para. 9.1.1.1	Para. 9.1.1.1	5000	-	M Ω
2	Voltage Proof Leakage Current	I_L	Para. 9.1.1.2	(1)	-	2	mA
3	Low Level Contact Resistance Gauge 20 Signal Contacts Gauge 22 Signal Contacts Coaxial Contacts Power Contacts	R_{CL}	Para. 9.1.1.3	Para. 9.1.1.3	- - - -	6 12 Note 2 Note 2	m Ω
4	Rated Current Contact Resistance	R_{CR}	Para. 9.1.1.3	Gauge 20: 7.5A Gauge 22: 3.0A Coaxial and Power Contacts	- -	5 10 Note 2	m Ω

NOTES:

1.
 - Gauge 20 contacts: 1250Vrms.
 - Gauge 22 contacts, power and straight coaxial contacts: 1000Vrms.
 - 90° coaxial contacts: 800Vrms.
 - For mixed contact arrangements, the voltage applied between dissimilar contacts shall be the higher that would be applied between either of the contacts in question tested with an identical

contact.

2. See ESCC Detail Specification Nos. 3401/004 and 3401/040 for coaxial and power contacts.

TABLES 3, 4 and 5

Not applicable.

4.6.3 Circuit for Electrical Measurements (Figure 4)

Not applicable.

4.7 BURN-IN AND ELECTRICAL MEASUREMENTS

Not applicable.

4.8 ENVIRONMENTAL AND ENDURANCE TESTS (CHARTS IV AND V OF ESCC GENERIC SPECIFICATION NO. 3401)

4.8.1 Measurements and Inspections on Completion of Environmental Tests

The parameters to be measured and inspections to be performed on completion of environmental testing shall be those specified in Table 6. Unless otherwise specified, the measurements shall be performed at $T_{amb} = +22 \pm 3^{\circ}\text{C}$.

4.8.2 Measurements and Inspections at Intermediate Points during Endurance Tests

Not applicable.

4.8.3 Measurements and Inspections on Completion of Endurance Tests

The parameters to be measured and inspections to be performed on completion of endurance tests shall be those specified in Table 6. Unless otherwise specified, the measurements shall be performed at $T_{amb} = +22 \pm 3^{\circ}\text{C}$.

4.8.4 Conditions for Operating Life Test (Part of Endurance Testing)

Not applicable.

4.8.5 Electrical Circuits for Operating Life Test (Figure 5)

Not applicable.

4.8.6 Conditions for High Temperature Storage Test (Part of Endurance Testing)

The requirements for the high temperature storage test are specified in Section 9 of ESCC Generic Specification No. 3401. The conditions for high temperature storage testing shall be the maximum storage temperature specified in Table 1(b) of this specification.

Table 6 - MEASUREMENTS AND INSPECTIONS ON COMPLETION OF ENVIRONMENTAL AND ENDURANCE TESTING

No.	ESCC Generic No. 3401		Measurements and Inspections		Symbol	Limits		Unit
	Environmental and Endurance Tests (1)	Test Method and Conditions	Identification	Conditions		Min	Max	
1	Seal Test	Para. 9.9	ESCC 3401 Para. 9.9	-	-	Not applicable		-
2	Wiring	Para. 9.10 & Table 1(a) of this spec	Low Level Contact Resist.	Table 2 Item 3	R _{CL}	Table 2 Item 3		mΩ
3	Vibration	Para. 9.11	Initial Measurements Coupling Screw(s) Unlocking Torque	-	-	Record Values		Nm
			Final Measurements Full Engagement Coupling Screw(s) Unlocking Torque Drift	-	Δ	-25	+25	%
			Visual Examination	-	-	-	-	-
4	Shock or Bump	Para. 9.12	Full Engagement Visual Examination	-	-	-	-	-
5	Climatic Sequence	Para. 9.13	Dry Heat Insulation Resistance	At High Temperature Table 2 Item 1	R _I	1000	-	MΩ
			Low Air Pressure Voltage Proof Leakage Current	Figure 1	I _L	Table 2 Item 2		mA
			Damp Heat Insulation Resistance	Immediately after test Table 2 Item 1	R _I	100	-	MΩ
			Final Measurement External Visual Inspection	After 1-24hrs Recovery ESCC 3401 Para. 9.7	-	ESCC 3401 Para. 9.7		-
			Insulation Resistance	Table 2 Item 1	R _I	Table 2 Item 1		MΩ
			Voltage Proof Leakage Current	Table 2 Item 2	I _L	Table 2 Item 2		mA
06	Plating Thickness	Para. 9.14	Thickness	-	-	Para. 4.4.3 of this spec		-
07	Joint Strength	Para. 9.15	ESCC 3401 Para. 9.15	-	-	ESCC 3401 Para 9.15		-
08	Rapid Change of Temperature	Para. 9.16	Visual Examination	-	-	-	-	-
			Insulation Resistance	Table 2 Item 1	R _I	Table 2 Item 1		MΩ

No.	ESCC Generic No. 3401		Measurements and Inspections		Symbol	Limits		Unit
	Environmental and Endurance Tests (1)	Test Method and Conditions	Identification	Conditions		Min	Max	
			Voltage Proof Leakage Current	Table 2 Item 2	I_L	Table 2 Item 2		mA
09	Contact Retention (in insert)	Para. 9.17 & 4.3.4 of this spec.	Contact Displacement	-	-	ESCC 3401 Para. 9.17		-
10	Endurance	Para. 9.18	Initial Measurements					
			Mating/Unmating Forces	-	F	Para. 4.3.5 of this spec		N
			Low Level Contact Resistance	Table 2 Item 3	R_{CL}	Record Values		m Ω
			Mated Shell Conductivity	-	-	Not applicable		-
			Final Measurements					
			Visual Examination	-	-	-	-	-
			Mating/Unmating Forces	-	F	Para. 4.3.5 of this spec		N
			Low Level Contact Resistance Drift	Table 2 Item 3	ΔR_{CL}	-	3	m Ω
Mated Shell Conductivity	-	-	Not applicable		-			
Insulation Resistance	Table 2 Item 1	R_I	Table 2 Item 1		M Ω			
Voltage Proof Leakage Current	Table 2 Item 2	I_L	Table 2 Item 2		mA			
11	Permanence of Marking	Para. 9.19	As applicable	-	-	-	-	-
12	Mating/Unmating Forces	Para. 9.20	Force	-	F	Para. 4.3.5 of this spec		N

No.	ESCC Generic No. 3401		Measurements and Inspections		Symbol	Limits		Unit
	Environmental and Endurance Tests (1)	Test Method and Conditions	Identification	Conditions		Min	Max	
13	High Temperature Storage	Para. 9.21	Initial Measurements					
			Low Level Contact Resistance	Table 2 Item 3	R _{CL}	Record Values		mΩ
			Mated Shell Conductivity	-	-	Not applicable		-
			Final Measurements					
			Visual Examination	-	-	-	-	-
			Mating/Unmating Forces	-	F	Para. 4.3.5 of this spec		N
			Low Level Contact Resistance Drift	Table 2 Item 3	ΔR _{CL}	-	3	mΩ
			Rated Current Contact Resistance	Table 2 Item 4	R _{CR}	Table 2 Item 4		mΩ
			Mated Shell Conductivity	-	-	Not applicable		-
Insulation Resistance	Table 2 Item 1	R _I	Table 2 Item 1		MΩ			
Voltage Proof Leakage Current	Table 2 Item 2	I _L	Table 2 Item 2		mA			
Contact Retention (in insert)	Para. 4.3.4 of this spec	-	ESCC 3401 Para. 9.17		N			
14	Corrosion	Para. 9.22	Visual Examination	-	-	-	-	
15	Insert Retention (in shell)	Para. 9.23 & Para. 4.3.6 of this spec	Visual Examination	-	-	Para. 4.3.6 of this spec		-
16	Jackscrew Retention	Para. 9.24 & Para. 4.3.7 of this spec	Visual Examination	-	-	Not applicable		-
17	High Temperature Measurements	Para. 9.25	Insulation Resistance	Table 2 Item 1	R _I	500	-	MΩ
18	Overload Test	Para. 9.26	Internal Temperature	-	T	-	+100	°C
			Rated Current Contact Resistance	Table 2 Item 4	R _{CR}	Table 2 Item 4		mΩ
			Mated Shell Conductivity	-	-	Not applicable		-
			Insulation Resistance	Table 2 Item 1	R _I	Table 2 Item 1		MΩ
Voltage Proof Leakage Current	Table 2 Item 2	I _L	Table 2 Item 2		mA			
19	Maintenance Aging	Para. 9.27 & Para. 4.2.4 of this spec	Visual Examination	-	-	-	-	-

No.	ESCC Generic No. 3401		Measurements and Inspections		Symbol	Limits		Unit
	Environmental and Endurance Tests (1)	Test Method and Conditions	Identification	Conditions		Min	Max	
			Contact Retention (in insert)	Para. 4.3.4 of this spec	-	ESCC 3401 Para. 9.17		N
			Contact Insertion and Withdrawal Forces	Para. 4.3.8 of this spec.	F	Para. 4.3.8 of this spec		N
20	Engage/Separation Forces	Para. 9.28 & Para. 4.3.9 of this spec	Force	-	F	Para. 4.3.9 of this spec		-
21	Oversize Pin Exclusion	Para. 9.29 & Para. 4.3.10 of this spec	-	-	-	ESCC 3401 Para. 9.29		-
22	Probe Damage	Para. 9.3 & Para. 4.3.11 of this spec.	Contact Separation Force	Para. 4.3.9 of this spec	F	Para. 4.3.9 of this spec		-
23	Solderability	Para. 9.31 & Para. 4.3.12 of this spec	-	-	-	ESCC 3401 Para. 9.31		-

NOTES:

1. The tests in this table refer to either Chart IV or V and shall be used as applicable.

APPENDIX A**AGREED DEVIATIONS FOR C&K COMPONENTS (F)**

Items Affected	Description of Deviations
Para. 4.2.2, Deviations from Final Production Tests (Chart II)	Para. 9.4, Contact Capability: 100% Contact Capability Test may be omitted for solder bucket, PCB and wire-wrap contacts provided that a 100% visual inspection of the contact and a 10% Contact Capability test are performed in accordance with the C&K PID requirements. The results of the Contact Capability test shall be considered for PDA.

APPENDIX B**AGREED DEVIATIONS FOR SOURIAU (F)**

Items Affected	Description of Deviations
Para. 4.2.2, Deviations from Final Production Tests (Chart II)	Para. 9.14, Electrical Measurements at Room Temperature: For solder bucket, PCB and wire-wrap contacts, Low Level Contact Resistance and Rated Current Contact Resistance measurements, performed in accordance with Table 2 of the Detail Specification, may be omitted provided that Low Level Contact Resistance measurements are performed on 10 contacts per contact batch, in accordance with the Souriau PID requirements. The results of the Low Level Contact Resistance measurements shall be considered for PDA.