



**CONNECTORS, ELECTRICAL, FOR PRINTED  
CIRCUIT BOARDS, REMOVABLE CONTACTS,  
CRIMP, WIRE-WRAP, SOLDER AND SAVER**

**BASED ON TYPE HE801**

**ESCC Detail Specification No. 3401/016**

Issue 4	June 2013
---------	-----------



### **LEGAL DISCLAIMER AND COPYRIGHT**

European Space Agency, Copyright © 2013, All rights reserved.

The European Space Agency disclaims any liability or responsibility, to any person or entity, with respect to any loss or damage caused, or alleged to be caused, directly or indirectly by the use and application of this ESCC publication.

This publication, without prior permission of the European Space Agency and provided it is not used for a commercial purpose, may be:

- copied in whole, in any medium, without alteration or modification.
- copied in part, in any medium, provided that the ESCC document identification, comprising the ESCC symbol, document number and document issue, is removed.

**DOCUMENTATION CHANGE NOTICE**

(Refer to <https://escies.org> for ESCC DCR content)

DCR No.	CHANGE DESCRIPTION
795	Specification upissued to incorporate editorial changes per DCR.

**TABLE OF CONTENTS**

1	GENERAL	6
1.1	SCOPE	6
1.2	RANGE OF COMPONENTS	6
1.3	MAXIMUM RATINGS	6
1.4	PARAMETER DERATING INFORMATION	6
1.5	PHYSICAL DIMENSIONS	6
2	APPLICABLE DOCUMENTS	6
3	TERMS, DEFINITIONS, ABBREVIATIONS, SYMBOLS AND UNITS	6
4	REQUIREMENTS	68
4.1	GENERAL	68
4.2	DEVIATIONS FROM GENERIC SPECIFICATION	68
4.2.1	DEVIATIONS FROM SPECIAL IN-PROCESS CONTROLS	68
4.2.2	DEVIATIONS FROM FINAL PRODUCTION TESTS (CHART II)	68
4.2.3	DEVIATIONS FROM BURN-IN AND ELECTRICAL MEASUREMENTS (CHART III)	68
4.2.4	DEVIATIONS FROM QUALIFICATION TESTS (CHART IV)	68
4.2.5	DEVIATIONS FROM LOT ACCEPTANCE TESTS (CHART V)	68
4.3	MECHANICAL REQUIREMENTS	69
4.3.1	DIMENSION CHECK	69
4.3.2	WEIGHT	69
4.3.3	CONTACT CAPABILITY	69
4.3.4	CONTACT RETENTION (IN INSERT)	69
4.3.5	MATING AND UNMATING FORCES	69
4.3.6	INSERT RETENTION (IN SHELL)	69
4.3.7	JACKSCREW RETENTION	69
4.3.8	CONTACT INSERTION AND WITHDRAWAL FORCES	69
4.3.9	ENGAGEMENT AND SEPARATION FORCES	69
4.3.10	OVERSIZE PIN EXCLUSION	69
4.3.11	PROBE DAMAGE	69
4.3.12	SOLDERABILITY	69
4.4	MATERIALS AND FINISHES	70
4.4.1	SHELLS	70
4.4.2	INSERTS	70
4.4.3	CONTACTS	70
4.4.4	CONTACT RETAINING CLIP	70
4.4.5	GUIDING AND LOCKING DEVICES	70
4.4.6	MAGNETISM LEVEL	70

4.5	MARKING	70
4.5.1	GENERAL	70
4.5.2	CONTACT POSITION	70
4.5.3	THE ESCC COMPONENT NUMBER	70
4.5.4	CHARACTERISTICS	71
4.5.4.2	INSERT	71
4.5.4.3	CONTACTS	71
4.5.4.4	GUIDING AND LOCKING DEVICES	71
4.5.5	TRACEABILITY INFORMATION	71
4.6	ELECTRICAL MEASUREMENTS	71
4.6.1	ELECTRICAL MEASUREMENTS AT ROOM TEMPERATURE	71
4.6.2	ELECTRICAL MEASUREMENTS AT HIGH AND LOW TEMPERATURES (TABLE 3)	72
4.6.3	CIRCUITS FOR ELECTRICAL MEASUREMENTS (FIGURE 4)	72
4.7	BURN-IN AND ELECTRICAL MEASUREMENTS (TABLES 4 AND 5)	72
4.8	ENVIRONMENTAL AND ENDURANCE TESTS (CHARTS IV AND V OF ESCC GENERIC SPECIFICATION NO. 3401)	72
4.8.1	MEASUREMENTS AND INSPECTIONS ON COMPLETION OF ENVIRONMENTAL TESTS	72
4.8.2	MEASUREMENTS AND INSPECTIONS AT INTERMEDIATE POINTS DURING ENDURANCE TESTS	72
4.8.3	MEASUREMENTS AND INSPECTIONS ON COMPLETION OF ENDURANCE TESTS	72
4.8.4	CONDITIONS FOR OPERATING LIFE TEST (PART OF ENDURANCE TESTING)	72
4.8.5	ELECTRICAL CIRCUITS FOR OPERATING LIFE TEST	72
4.8.6	CONDITIONS FOR HIGH TEMPERATURE STORAGE TEST (PART OF ENDURANCE TESTING)	72

## **1 GENERAL**

### **1.1 SCOPE**

This specification details the ratings, physical and electrical characteristics, test and inspection data of Electrical Connectors for Printed Circuit Boards, Removable Contacts, Crimp, Wire-wrap, Solder and Saver, based on Type HE801. It shall be read in conjunction with:

- ESCC Generic Specification No. 3401, Connectors, Electrical, Non-Filtered, Circular and Rectangular
- ESCC Detail Specification No. 3401/017, Contacts, Electrical, Crimp, Wire-Wrap, Solder and Saver, for 3401/016 Connectors

the requirements of which are supplemented herein.

Crimp contacts are delivered separately from the inserts.

Wire-Wrap, solder and saver contacts are delivered mounted in the inserts.

#### **N.B.**

Saver contacts may be mounted in other plug or receptacle inserts.

### **1.2 RANGE OF COMPONENTS**

The different configurations of the connectors and contacts specified herein, guiding and locking devices, compatibilities between inserts and contacts, between inserts and guiding devices and between inserts and locking devices are given in Table 1(a).

### **1.3 MAXIMUM RATINGS**

The maximum ratings applicable to the connectors specified herein, which shall not be exceeded at any time during use or storage, are scheduled in Table 1(b).

### **1.4 PARAMETER DERATING INFORMATION**

The applicable derating information for the connectors specified herein is shown in Figure 1.

### **1.5 PHYSICAL DIMENSIONS**

The physical dimensions of the connectors, plugs and receptacles, guiding and locking devices specified herein and the contact mounting configurations are shown in Figures 2(a), 2(b) and 2(c).

## **2 APPLICABLE DOCUMENTS**

The following documents form part of this specification and shall be read in conjunction with it:

- (a) ESCC Generic Specification No. 3401 for Connectors, Electrical, Non-Filtered, Circular and Rectangular.
- (b) ESCC Detail Specification No. 3401/017, Contacts, Electrical, Crimp, Wire-Wrap, Solder and Saver for 3401/016 Connectors.

## **3 TERMS, DEFINITIONS, ABBREVIATIONS, SYMBOLS AND UNITS**

For the purpose of this specification, the terms, definitions, abbreviations, symbols and units specified in ESCC Basic Specification No. 21300 shall apply.

**TABLE 1(a) – RANGE OF COMPONENTS**

INSERTS, PLUGS AND RECEPTACLES

Code No.	Description	Contact Insertion and Removal	Compatibility between Inserts and Contacts																											
			Crimp Code No.		Wire-Wrap Code No.					Solder and Saver Code No.																				
			04	15	10	11	21	22	01	02	03	06	07	08	12	13	14	17	18	19	64	65	66	67	68	69	70			
01	Plug 2 rows 17 cts	Rear	X	X		X		X	X	X			X	X	X	X			X	X	X	X		X	X	X				
02	Plug 2 rows 29 cts	Rear	X	X		X		X	X	X			X	X	X	X			X	X	X	X		X	X	X				
03	Plug 2 rows 41 cts	Rear	X	X		X		X	X	X			X	X	X	X			X	X	X	X		X	X	X				
04	Plug 2 rows 53 cts	Rear	X	X		X		X	X	X			X	X	X	X			X	X	X	X		X	X	X				
05	Plug 2 rows 65 cts	Rear	X	X		X		X	X	X			X	X	X	X			X	X	X	X		X	X	X				
06	Plug 2 rows 65 cts	Rear							X	X																				
07	Plug 2 rows 84 cts	Rear	X	X		X		X	X	X			X	X	X	X			X	X	X	X		X	X	X				
08	Plug 2 rows 96 cts	Rear	X	X		X		X	X	X			X	X	X	X			X	X	X	X		X	X	X				
09	Not to be used																													
10	Plug 2 rows 120 cts	Rear	X	X		X		X	X	X			X	X	X	X			X	X	X	X		X	X	X				
11	Not to be used																													
12	Plug 3 rows 160 cts	Rear	X	X		X		X	X	X	X		X	X	X	X	X		X	X	X	X	X	X	X	X	X			
13	Receptacle 2 rows 17 cts	Rear	X	X		X		X	X	X			X	X	X	X			X	X	X	X		X	X	X				
14	Receptacle 2 rows 29 cts	Rear	X	X		X		X	X	X			X	X	X	X			X	X	X	X		X	X	X				
15	Receptacle 2 rows 41 cts	Rear	X	X		X		X	X	X			X	X	X	X			X	X	X	X		X	X	X				
16	Receptacle 2 rows 53 cts	Rear	X	X		X		X	X	X			X	X	X	X			X	X	X	X		X	X	X				
17	Receptacle 2 rows 65 cts	Rear	X	X		X		X	X	X			X	X	X	X			X	X	X	X		X	X	X				
18	Receptacle 2 rows 65 cts	Rear																			X									
19	Receptacle 2 rows 84 cts	Rear	X	X		X		X	X	X			X	X	X	X			X	X	X	X		X	X	X				
20	Receptacle 2 rows 96 cts	Rear	X	X		X		X	X	X			X	X	X	X			X	X	X	X		X	X	X				
21	Not to be used																													
22	Receptacle 2 rows 120 cts	Rear	X	X		X		X	X	X			X	X	X	X			X	X	X	X		X	X	X				
23	Not to be used																													
24	Receptacle 3 rows 160 cts	Rear	X	X		X		X	X	X	X		X	X	X	X	X		X	X	X	X	X	X	X	X	X			
25	Receptacle 3 rows 160 cts (1)	Front			X		X					X						X												
56	Plug 2 rows 72 cts	Rear	X	X		X		X	X	X			X	X	X	X			X	X	X	X		X	X	X				
57	Receptacle 2 rows 72 cts	Rear	X	X		X		X	X	X			X	X	X	X			X	X	X	X		X	X	X				
58	Plug 3 rows 62 cts	Rear	X	X		X		X	X	X	X		X	X	X	X	X		X	X	X	X	X	X	X	X	X			
59	Receptacle 3 rows 62 cts	Rear	X	X		X		X	X	X	X		X	X	X	X	X		X	X	X	X	X	X	X	X	X			
60	Plug 3 rows 80 cts	Rear	X	X		X		X	X	X	X		X	X	X	X	X		X	X	X	X	X	X	X	X	X			
61	Receptacle 3 rows 80 cts	Rear	X	X		X		X	X	X	X		X	X	X	X	X		X	X	X	X	X	X	X	X	X			
62	Plug 3 rows 98 cts	Rear	X	X		X		X	X	X	X		X	X	X	X	X		X	X	X	X	X	X	X	X	X			
63	Receptacle 3 rows 98 cts	Rear	X	X		X		X	X	X	X		X	X	X	X	X		X	X	X	X	X	X	X	X	X			
64	Plug 3 rows 160 cts shrouded	Rear	X	X		X		X	X	X	X		X	X	X	X	X		X	X	X	X	X	X	X	X	X			

**NOTES**

1. Not to be used for new design. Replace by Code 24.



GUIDING AND LOCKING DEVICES

	Code No.	Description	For thick PCB (mm)	For Connectors 2 or 3 rows	For all (X) inserts or Code 25
Guiding Device	26	Unpolarised male guide, transverse mounting	1.6	2	X
	27	Unpolarised male guide, transverse mounting	1.6	3	X
	28	Unpolarised male guide, vertical mounting	-	2 or 3	X
	29	Unpolarised female guide, vertical mounting	-	2 or 3	X
	30	Unpolarised female guide, vertical mounting	-	3	25
	31	Unpolarised male guide, transverse mounting	-	2	X
	32	Unpolarised female guide, transverse mounting	-	2	X
	33	Polarised male guide, transverse mounting	1.6	2	X
	34	Polarised male guide, transverse mounting	1.6	3	X
	35	Polarised male guide, vertical mounting	-	2 or 3	X
	36	Polarised female guide, vertical mounting (on ends/centre)	-	2 or 3	X
	37	Polarised female guide, vertical mounting (on ends)	-	3	25
	38	Polarised female guide, vertical mounting (on centre)	-	3	25
	39	Polarised male guide, vertical mounting	-	3	25
	40	Polarised male guide, transverse mounting	-	2	X
	41	Polarised female guide, transverse mounting	-	2	X
Locking Device	42	Rotating jack socket lock	-	3	25
	43	Non rotating jack screw lock, transverse mounting	1.6	3	X
	44	Non rotating jack screw lock, vertical mounting	-	3	25
	45	Rotating jack socket lock	-	2 or 3	X
	46	Non rotating jack screw lock, vertical mounting	-	2 or 3	X
	47	Rotating jack screw lock with polarised guide	-	2 or 3	X
	48	Jack socket lock/polarised guide, transverse mounting	1.6	2	X
	49	Jack socket lock/polarised guide, transverse mounting	1.6	3	X
	50	Jack socket lock/polarised guide, vertical mounting	-	2 or 3	X
	51	Rotating jack screw lock with polarised guide	-	2	X
	52	Jack screw lock, transverse mounting	-	2	X
	53	Jack screw lock, vertical mounting	-	2 or 3	X
	Guiding Device	54	Polarised female guide, vertical floating mounting	-	2 or 3
55		Polarised male guide, vertical floating mounting	-	2 or 3	X
71		Unpolarised male guide, transverse mounting	2.4	2	X
72		Polarised male guide, transverse mounting	2.4	2	X
Locking Device	73	Non rotating jack screw lock, transverse mounting	2.4	2	X
Guiding Device	74	Polarised female guide, transverse mounting	-	3	X
	75	Unpolarised female guide, transverse mounting	-	3	X
	76	Polarised male guide, transverse mounting	2.4 & 3.2	3	X
	77	Unpolarised male guide, transverse mounting	2.4 & 3.2	3	X
Locking Device	78	Rotating jack socket lock	-	2 or 3	X
	79	Jack socket lock with polarised guide	1.6	2	X
	80	Jack socket lock with polarised guide, vertical mounting	-	2 or 3	X
	81	Rotating jack screw lock with polarised guide	-	2 or 3	X





INTERMATEABILITY CHART, INSERTS AND LOCKING DEVICES

-  Compatible
-  Compatible only when used on end of insert
-  Mateable

Reading Way	63	61	59	57	25	24	22	20	19	18	17	16	15	14	13	RECEPTACLE	INSERTS
	64	62	60	58	56	12	10	08	07	06	05	04	03	02	01	PLUG	

63	61	59	57	25	24	22	20	19	18	17	16	15	14	13	64	62	60	58	56	12	10	08	07	06	05	04	03	02	01	80	79	78	53	52	50	49	48	45	42	Code	LOCKING DEVICES MALE
RECEPTACLE															PLUG										LOCKING DEVICES FEMALE																
INSERTS																									LOCKING DEVICES FEMALE																

← Reading Way →



**NOTES**

1. Instructions for reading table on Page 11.

READING EXAMPLE FOR THE COMPATIBILITY TABLES OF INSERTS AND GUIDING AND LOCKING DEVICES

Having, for instance, 120 contacts, 2-row connectors, the plug is identified as code 10 and the receptacle is identified as code 22 (see Table 1(a) Range of Components - Intermateability Chart - Inserts and guiding devices), you wish to have male guiding devices mounted on your plug.

Male guiding devices appear on the right hand lower side of the table, so you would read the table horizontally to find which of the male guides may be mounted on plug code 10 (bottom centre) : you look for a device with:

a  or a  for end guides, you the possibility to mount male guide codes 33, 72, 35, 40 or 55.

a  for centre guides, you have the possibility to mount male devices code 26, 71, 28 or 31.

You now need to find the female guides that may be mounted on the opposite receptacle and also that mate with the above male guides that may be mounted on the plug.

Female guiding devices appear at the bottom right hand side of the table. Reading the table vertically upwards, you will find a  which indicates mateability with the opposite guide.

For female end guides, codes 36 and 41 mate with all the male guides mentioned above, codes 37 and 38 only mate with code 35, code 74 mates with 35 and 55, code 54 mates with codes 35, 40 and 55.

For female centre guides, codes 74, 30 and 75 mate with code 28, codes 29 and 32 mate with codes 26, 71, 28 and 31.

Are these codes compatible with receptacle code 22 (top right of table)?

Where you have identified a mating possibility (  ), read the table vertically upwards to arrive at receptacle code 22.

You see that you may use female devices 36, 41 or 54 on the end of the receptacle and 29 or 32 for the centre.

The same reading method applies to locking devices.

When the customer does not specify any guiding or locking device, the connectors shall be delivered with the following devices:

- PLUGS are equipped with male devices
  - On the ends of 2 row plug: code 33
  - On the centre of 2 row plug: code 26
  - On the ends of 3 row plug: code 34
  - On the centre of 3 row plug: code 27
  
- RECEPTACLES are equipped with female devices
  - On the ends: code 36
  - On the centre: code 29

**TABLE 1(b) MAXIMUM RATINGS**

No.	Characteristic	Symbol	Maximum Rating	Unit	Remarks
1	Working Voltage, Sea Level	V	300	Vrms	Note 1
2	Rated Current	I	5	A	
3	Operating Temperature Range	T <sub>op</sub>	-55 to +125	°C	
4	Storage Temperature Range	T <sub>stg</sub>	-55 to +125	°C	
5	Soldering Temperature	T <sub>sol</sub>	+260	°C	Note 2

**NOTES**

1. Between contacts.
2. Duration 10 seconds maximum and the same contact shall not be resoldered until 3 minutes have elapsed.

**FIGURE 1 - PARAMETER DERATING INFORMATION**

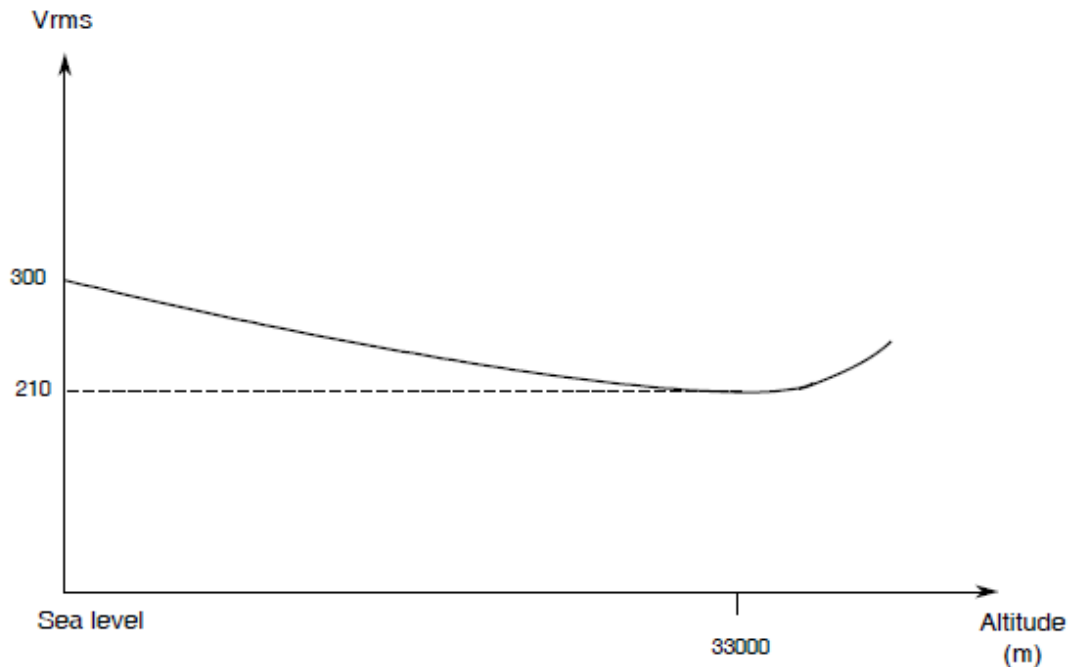

Working Voltage versus Altitude

**FIGURE 2 – PHYSICAL DIMENSIONS**

**FIGURE 2(a) – INSERTS: PLUGS AND RECEPTACLES**

**CODE 01 – PLUG, 2 ROWS, 17 CONTACTS**

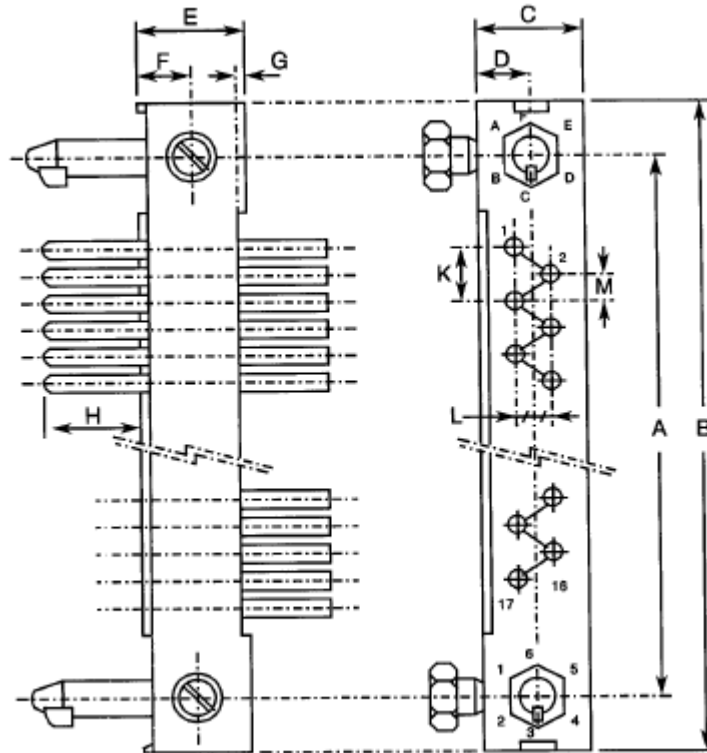

Symbol	Millimetres	
	Min	Max
A	30.33	30.63
B	38	38.5
C	6.3	6.4
D	3.1	3.3
E	7.75	8.05
F	3.8	4
G	0.25	0.6
H	3.6	4.8
K	2.39	2.69
L	2.39	2.69
M	1.12	1.42

**NOTES**

1. Weight: 2.3g.
2. Orientation of labelling of contacts and guiding devices is not a true representation.
3. The front of the insert shall be marked with the minimum marking shown.

CODE 02 – PLUG, 2 ROWS, 29 CONTACTS

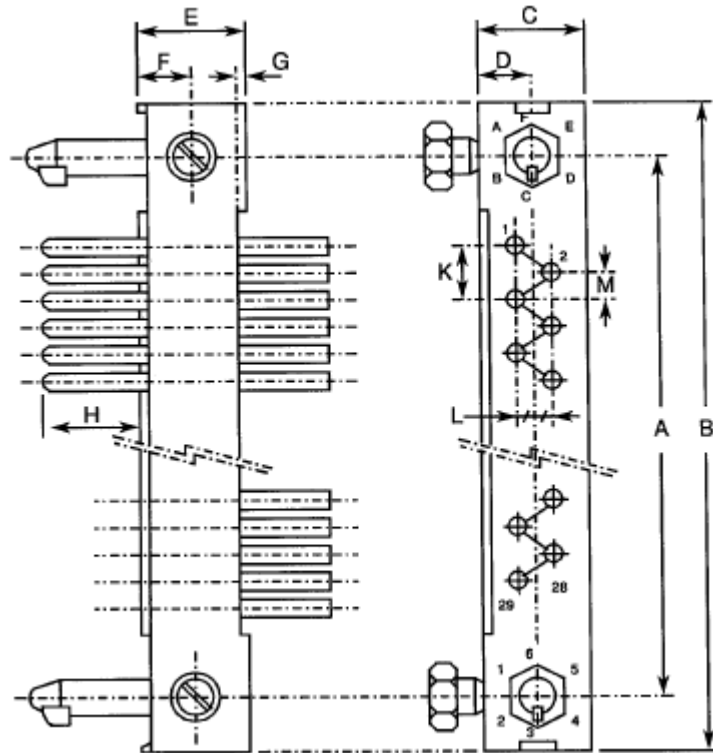

Symbol	Millimetres	
	Min	Max
A	45.57	45.87
B	53.2	53.7
C	6.3	6.4
D	3.1	3.3
E	7.75	8.05
F	3.8	4
G	0.25	0.6
H	3.6	4.8
K	2.39	2.69
L	2.39	2.69
M	1.12	1.42

**NOTES**

1. Weight: 3.1g.
2. Orientation of labelling of contacts and guiding devices is not a true representation.
3. The front of the insert shall be marked with the minimum marking shown.

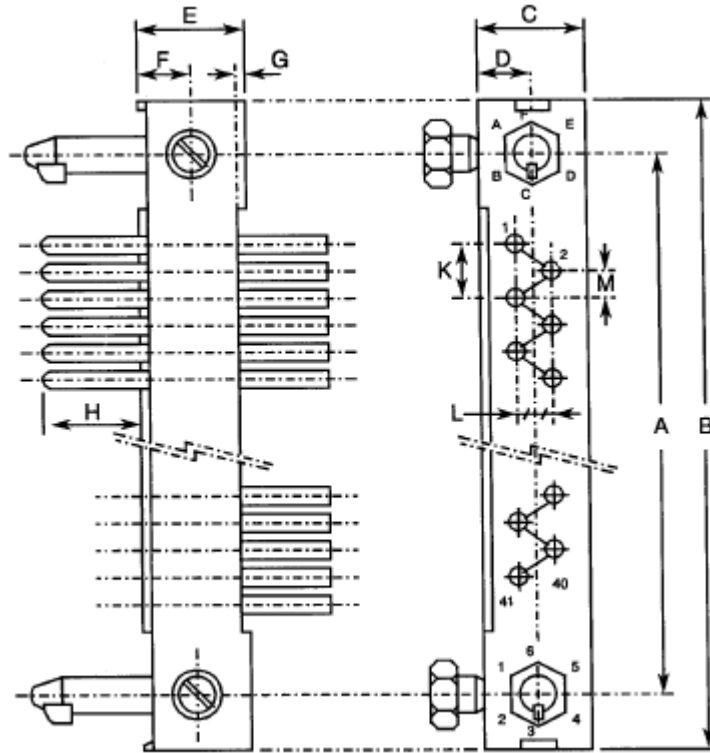
**CODE 03 – PLUG, 2 ROWS, 41 CONTACTS**

Symbol	Millimetres	
	Min	Max
A	60.81	61.11
B	68.5	69
C	6.3	6.4
D	3.1	3.3
E	7.75	8.05
F	3.8	4
G	0.25	0.6
H	3.6	4.8
K	2.39	2.69
L	2.39	2.69
M	1.12	1.42

**NOTES**

1. Weight: 3.8g.
2. Orientation of labelling of contacts and guiding devices is not a true representation.
3. The front of the insert shall be marked with the minimum marking shown.

CODE 04 – PLUG, 2 ROWS, 53 CONTACTS

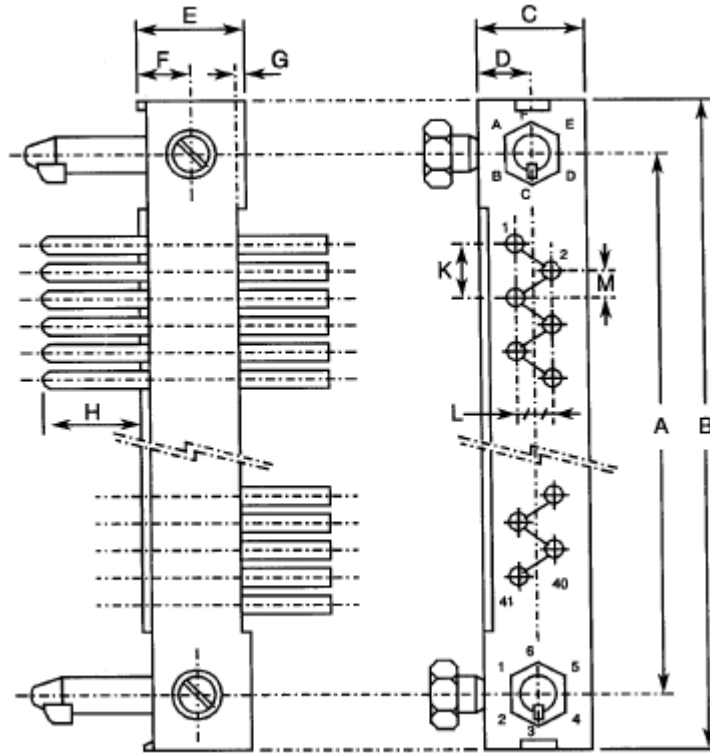

Symbol	Millimetres	
	Min	Max
A	76.05	76.35
B	83.7	84.2
C	6.3	6.4
D	3.1	3.3
E	7.75	8.05
F	3.8	4
G	0.25	0.6
H	3.6	4.8
K	2.39	2.69
L	2.39	2.69
M	1.12	1.42

**NOTES**

1. Weight: 4.7g.
2. Orientation of labelling of contacts and guiding devices is not a true representation.
3. The front of the insert shall be marked with the minimum marking shown.



CODE 05 – PLUG, 2 ROWS, 65 CONTACTS

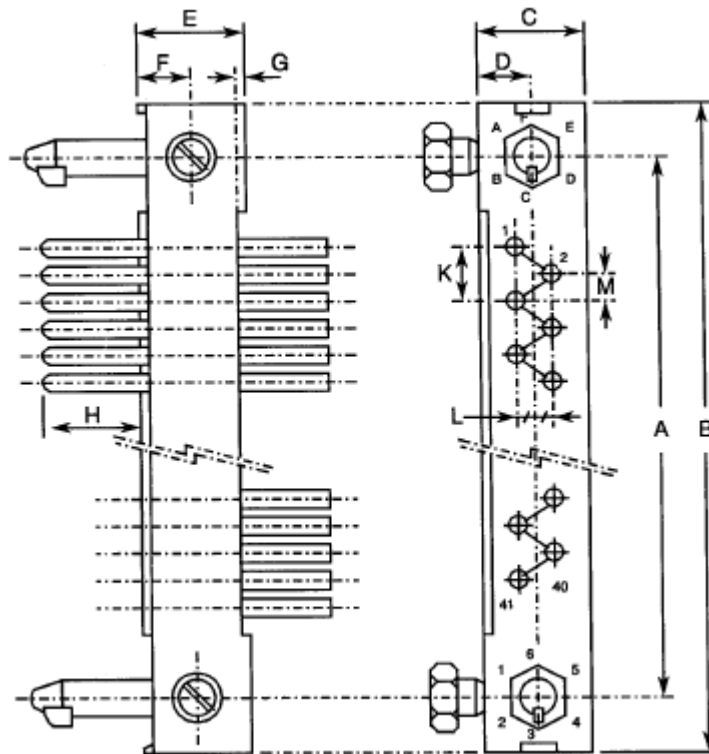

Symbol	Millimetres	
	Min	Max
A	91.29	91.59
B	99	99.5
C	6.3	6.4
D	3.1	3.3
E	7.75	8.05
F	3.8	4
G	0.25	0.6
H	3.6	4.8
K	2.39	2.69
L	2.39	2.69
M	1.12	1.42

**NOTES**

1. Weight: 5.5g.
2. Orientation of labelling of contacts and guiding devices is not a true representation.
3. The front of the insert shall be marked with the minimum marking shown.

CODE 06 – PLUG, 2 ROWS, 65 CONTACTS

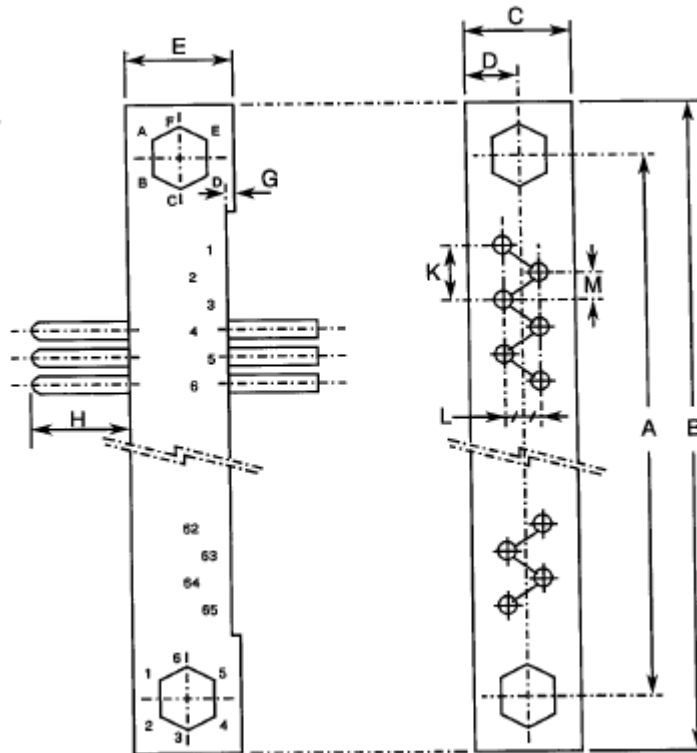

Symbol	Millimetres	
	Min	Max
A	91.29	91.59
B	99	99.5
C	6.3	6.4
D	3.1	3.3
E	7.45	7.75
G	0.25	0.6
H	3.6	4.8
K	2.39	2.69
L	2.39	2.69
M	1.12	1.42

**NOTES**

1. Weight: 5.5g.
2. Orientation of labelling of contacts and guiding devices is not a true representation.
3. The front of the insert shall be marked with the minimum marking shown.

CODE 07 – PLUG, 2 ROWS, 84 CONTACTS

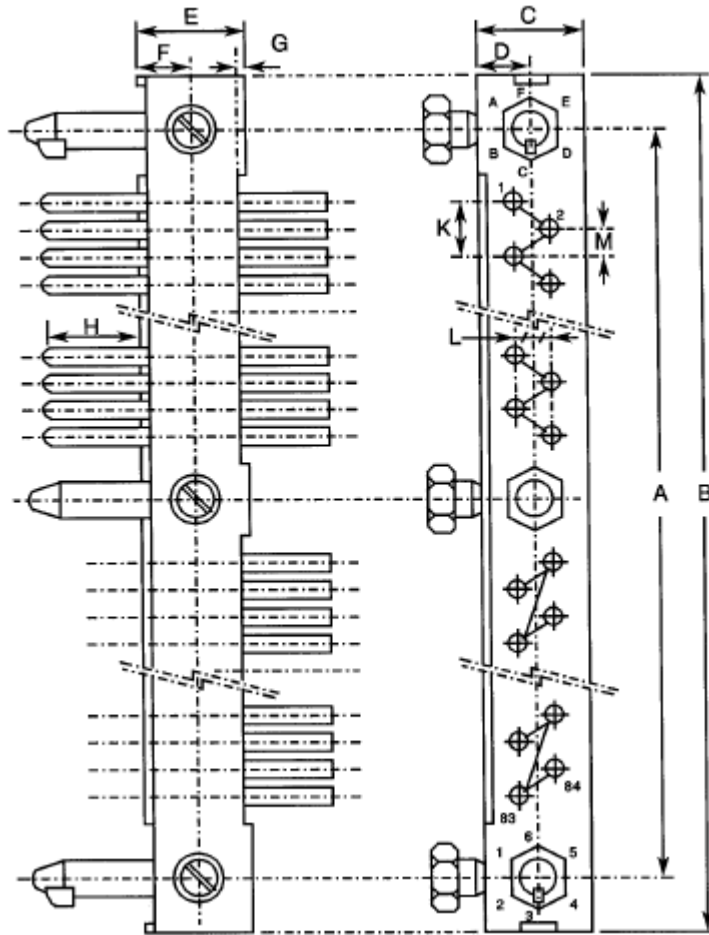

Symbol	Millimetres	
	Min	Max
A	121.77	122.07
B	129.4	129.9
C	6.3	6.4
D	3.1	3.3
E	7.75	8.05
F	3.8	4
G	0.25	0.6
H	3.6	4.8
K	2.39	2.69
L	2.39	2.69
M	1.12	1.42

**NOTES**

1. Weight: 7.1g.
2. Orientation of labelling of contacts and guiding devices is not a true representation.
3. The front of the insert shall be marked with the minimum marking shown.

CODE 08 – PLUG, 2 ROWS, 96 CONTACTS

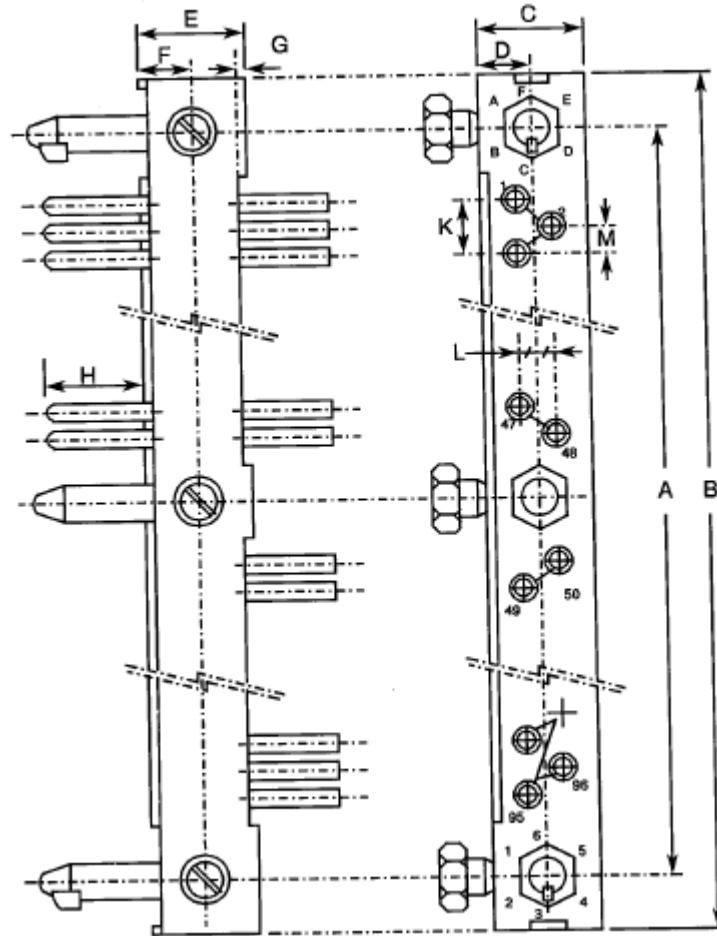

Symbol	Millimetres	
	Min	Max
A	137.01	137.31
B	144.7	145.2
C	6.3	6.4
D	3.1	3.3
E	7.75	8.05
F	3.8	4
G	0.25	0.6
H	3.6	4.8
K	2.39	2.69
L	2.39	2.69
M	1.12	1.42

**NOTES**

1. Weight: 8.5g.
2. Orientation of labelling of contacts and guiding devices is not a true representation.
3. The front of the insert shall be marked with the minimum marking shown.

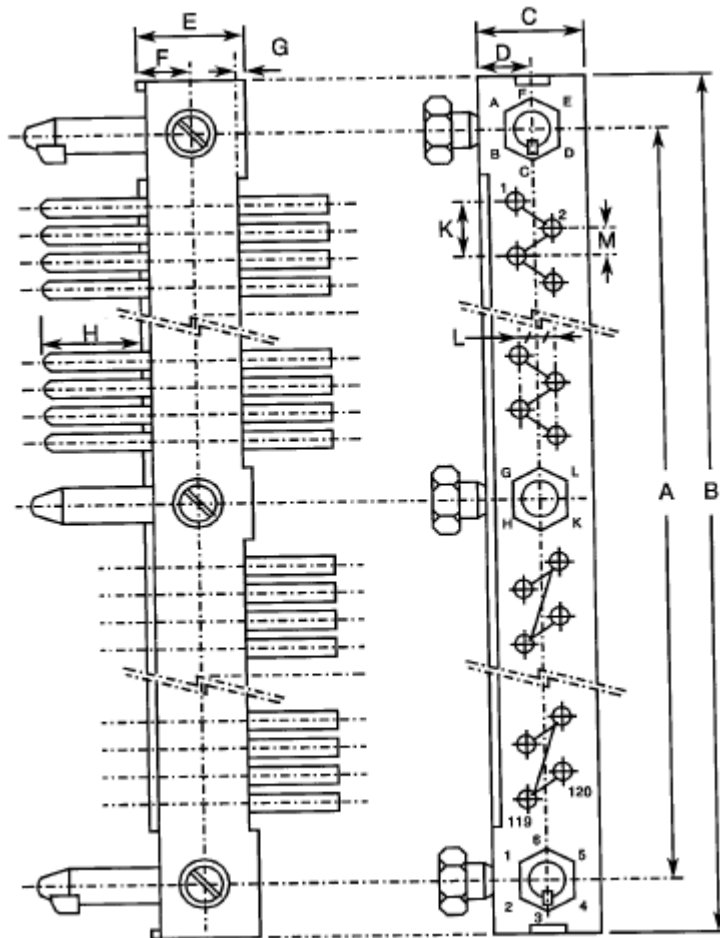
**CODE 10 – PLUG, 2 ROWS, 120 CONTACTS**

Symbol	Millimetres	
	Min	Max
A	167.49	167.79
B	175.1	175.6
C	6.3	6.4
D	3.1	3.3
E	7.75	8.05
F	3.8	4
G	0.25	0.6
H	3.6	4.8
K	2.39	2.69
L	2.39	2.69
M	1.12	1.42

**NOTES**

1. Weight: 9.4g.
2. Orientation of labelling of contacts and guiding devices is not a true representation.
3. The front of the insert shall be marked with the minimum marking shown.

CODE 12 – PLUG, 3 ROWS, 160 CONTACTS

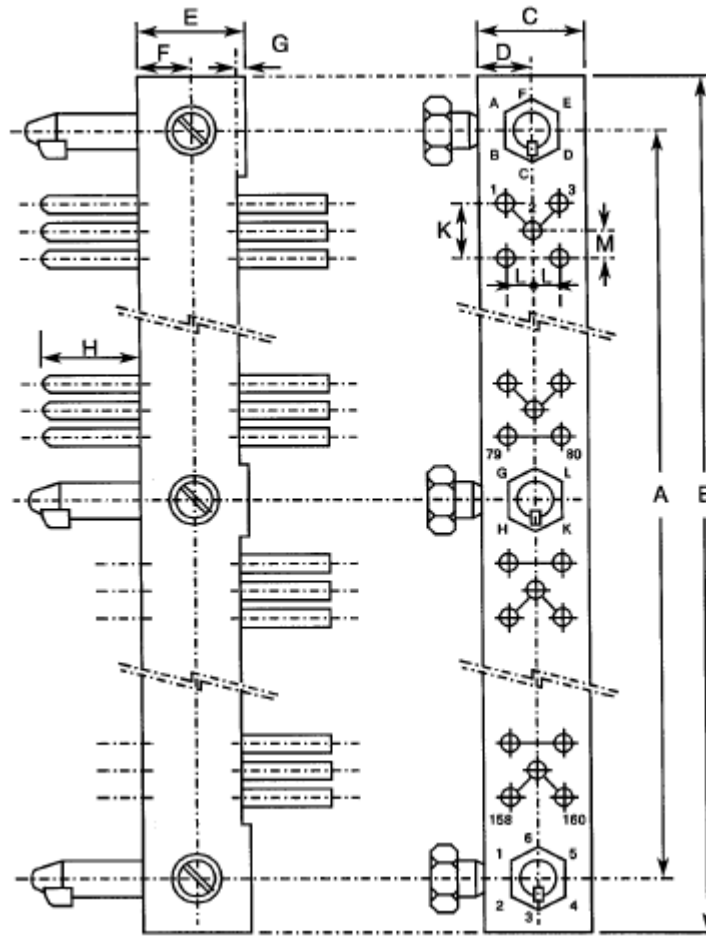

Symbol	Millimetres	
	Min	Max
A	149.71	150.01
B	157.5	158
C	9.2	9.3
D	4.55	4.75
E	7.75	8.05
F	3.8	4
G	0.25	0.6
H	3.6	4.8
K	2.39	2.69
L	2.39	2.69
M	1.12	1.42

**NOTES**

1. Weight: 12.6g.
2. Orientation of labelling of contacts and guiding devices is not a true representation.
3. The front of the insert shall be marked with the minimum marking shown.

CODE 13 – RECEPTACLE, 2 ROWS, 17 CONTACTS

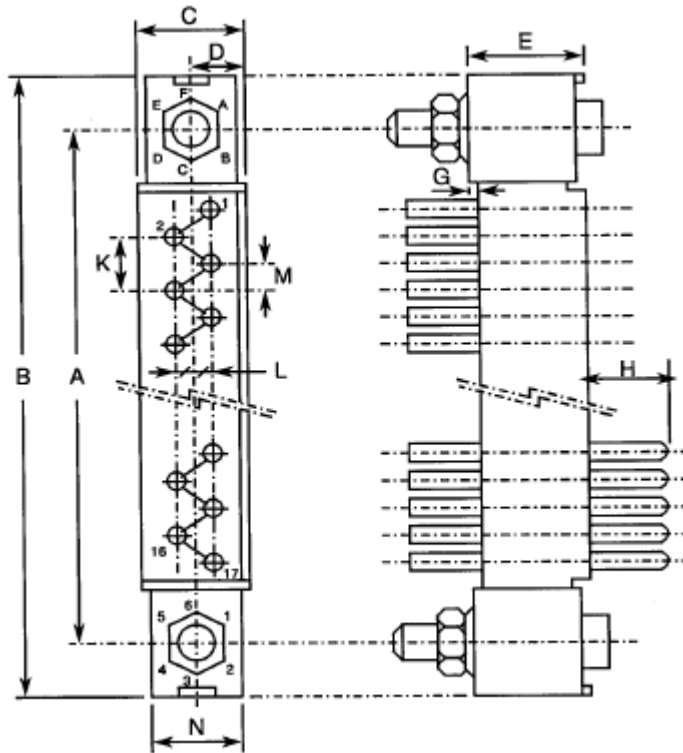

Symbol	Millimetres	
	Min	Max
A	30.33	30.63
B	38	38.5
C	6.3	7
D	2.8	3.05
E	7.75	8.05
G	0.25	0.6
H	3.6	4.8
K	2.39	2.69
L	2.39	2.69
M	1.12	1.42
N	6.1	6.4

**NOTES**

1. Weight: 2.5g.
2. Orientation of labelling of contacts and guiding devices is not a true representation.
3. The front of the insert shall be marked with the minimum marking shown.

CODE 14 – RECEPTACLE, 2 ROWS, 29 CONTACTS

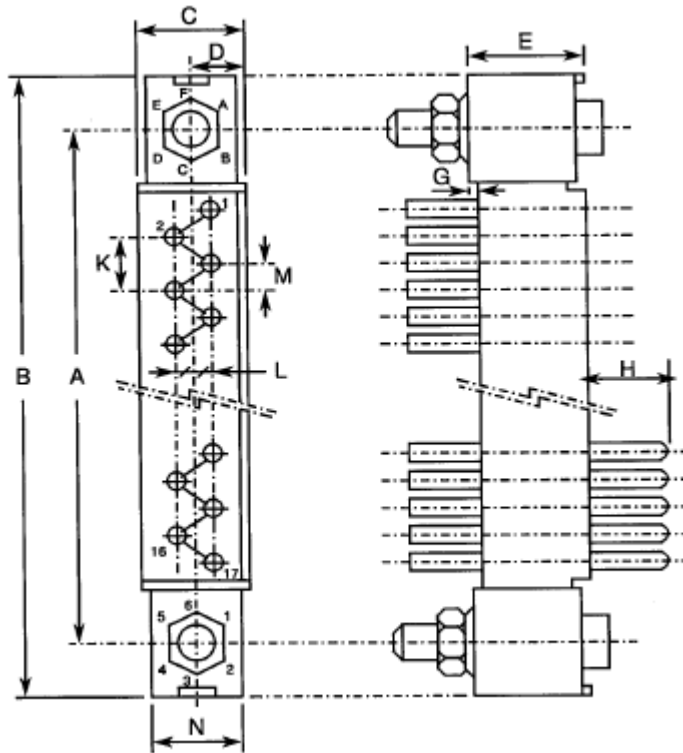

Symbol	Millimetres	
	Min	Max
A	45.57	45.87
B	53.2	53.7
C	6.3	7
D	2.8	3.05
E	7.75	8.05
G	0.25	0.6
H	3.6	4.8
K	2.39	2.69
L	2.39	2.69
M	1.12	1.42
N	6.1	6.4

**NOTES**

1. Weight: 3.3g.
2. Orientation of labelling of contacts and guiding devices is not a true representation.
3. The front of the insert shall be marked with the minimum marking shown.



CODE 15 – RECEPTACLE, 2 ROWS, 41 CONTACTS

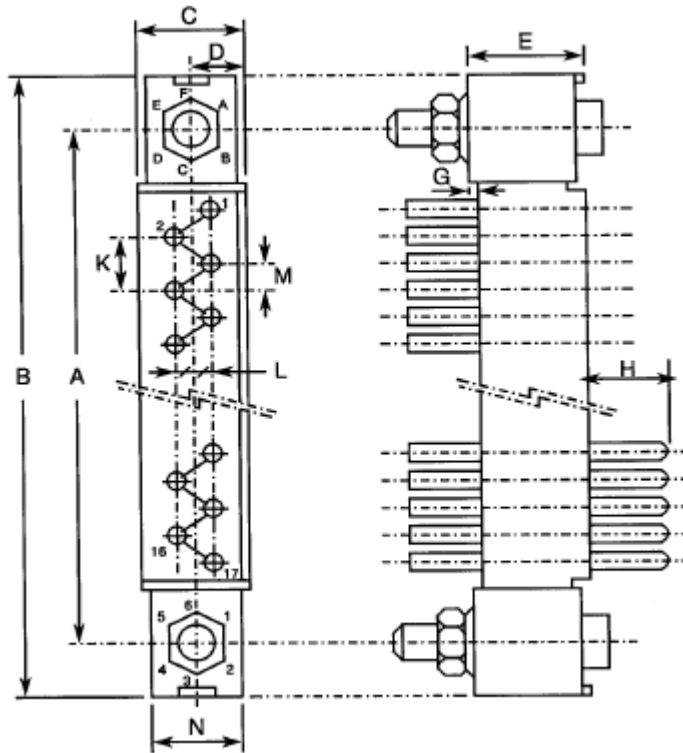

Symbol	Millimetres	
	Min	Max
A	60.81	61.11
B	68.5	69
C	6.3	7
D	2.8	3.05
E	7.75	8.05
G	0.25	0.6
H	3.6	4.8
K	2.39	2.69
L	2.39	2.69
M	1.12	1.42
N	6.1	6.4

**NOTES**

1. Weight: 4.2g.
2. Orientation of labelling of contacts and guiding devices is not a true representation.
3. The front of the insert shall be marked with the minimum marking shown.

CODE 16 – RECEPTACLE, 2 ROWS, 53 CONTACTS

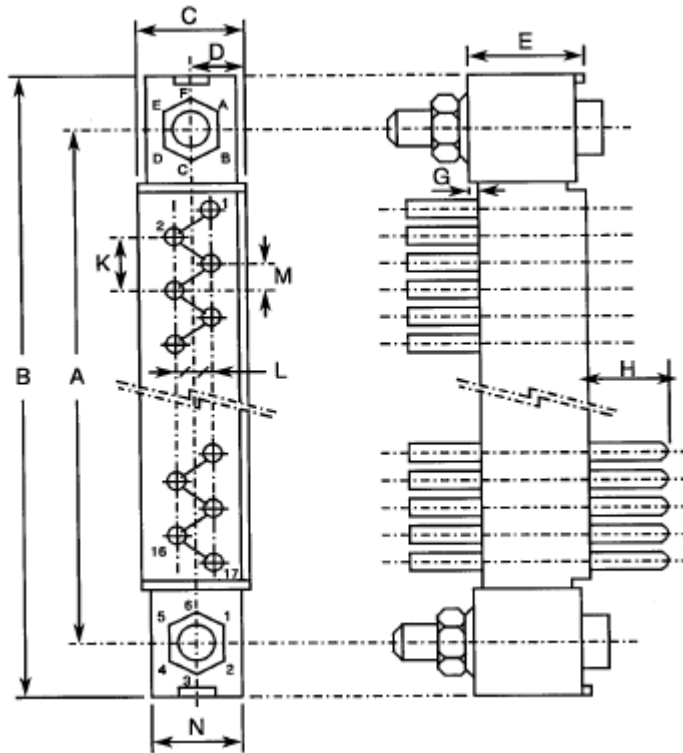

Symbol	Millimetres	
	Min	Max
A	76.05	76.35
B	83.7	84.2
C	6.3	7
D	2.8	3.05
E	7.75	8.05
G	0.25	0.6
H	3.6	4.8
K	2.39	2.69
L	2.39	2.69
M	1.12	1.42
N	6.1	6.4

**NOTES**

1. Weight: 5.3g.
2. Orientation of labelling of contacts and guiding devices is not a true representation.
3. The front of the insert shall be marked with the minimum marking shown.

CODE 17 – RECEPTACLE, 2 ROWS, 65 CONTACTS

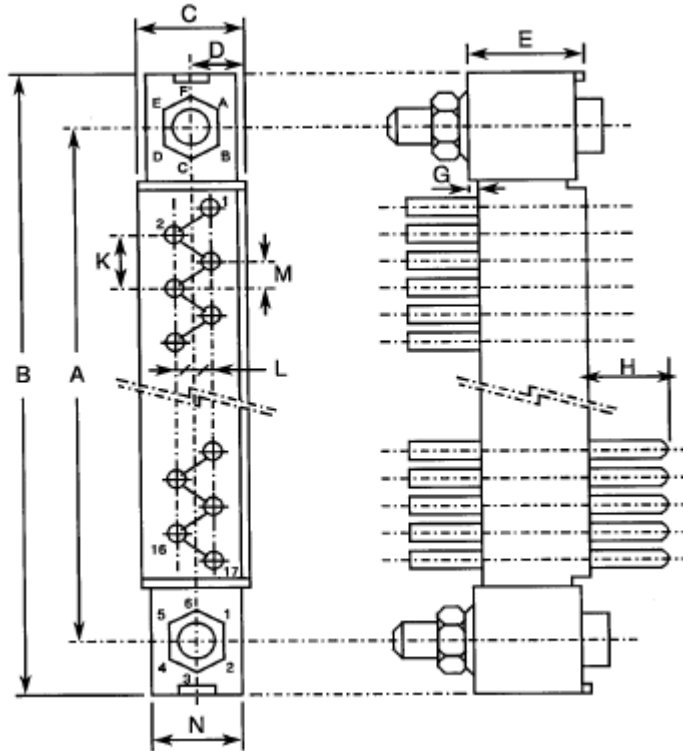

Symbol	Millimetres	
	Min	Max
A	91.29	91.59
B	99	99.5
C	6.3	7
D	2.8	3.05
E	7.75	8.05
G	0.25	0.6
H	3.6	4.8
K	2.39	2.69
L	2.39	2.69
M	1.12	1.42
N	6.1	6.4

**NOTES**

1. Weight: 6g.
2. Orientation of labelling of contacts and guiding devices is not a true representation.
3. The front of the insert shall be marked with the minimum marking shown.

CODE 18 – RECEPTACLE, 2 ROWS, 65 CONTACTS

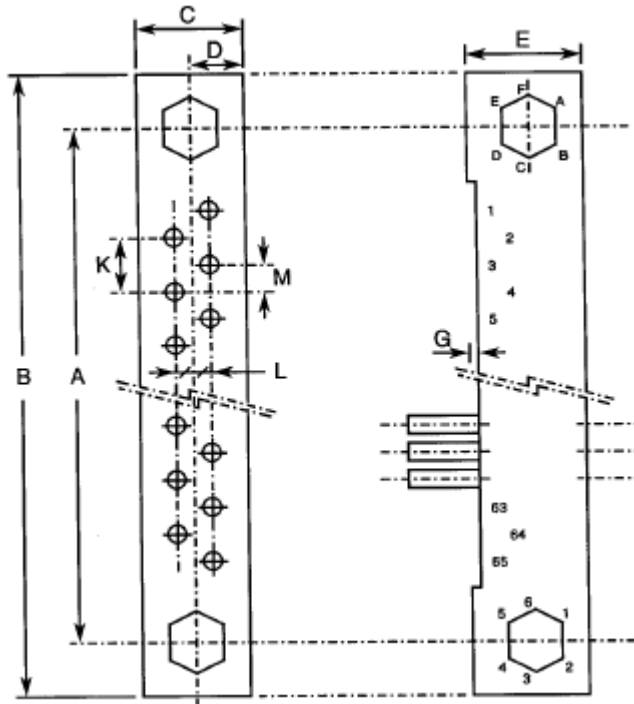

Symbol	Millimetres	
	Min	Max
A	91.29	91.59
B	99	99.5
C	6.3	6.4
D	3.1	3.3
E	7.45	7.75
G	0.25	0.6
K	2.39	2.69
L	2.39	2.69
M	1.12	1.42

**NOTES**

1. Weight: 5.5g.
2. Orientation of labelling of contacts and guiding devices is not a true representation.
3. The front of the insert shall be marked with the minimum marking shown.

CODE 19 – RECEPTACLE, 2 ROWS, 84 CONTACTS

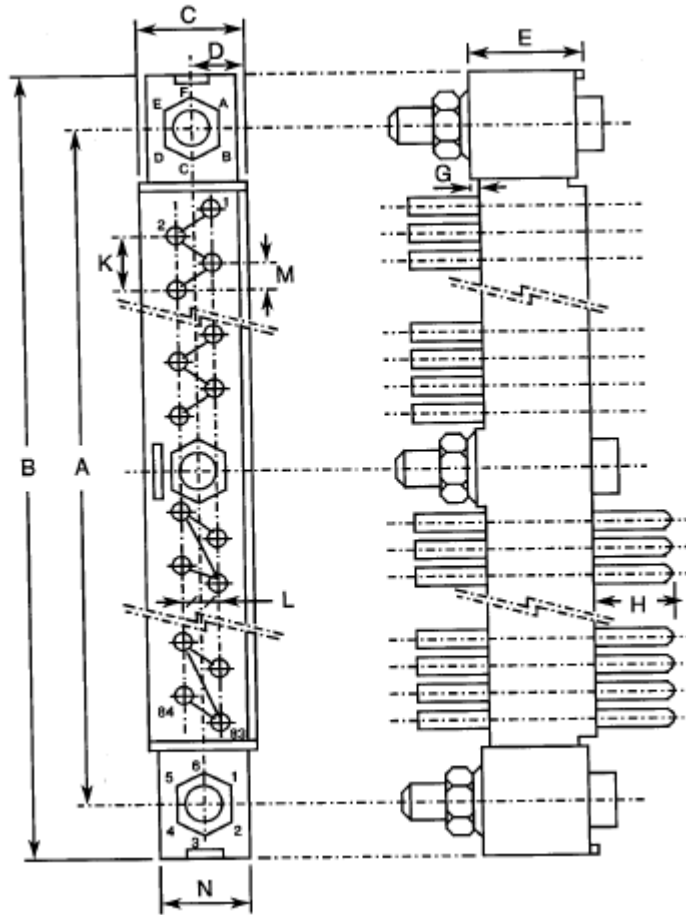

Symbol	Millimetres	
	Min	Max
A	121.77	122.07
B	129.4	129.9
C	6.3	7
D	2.8	3.05
E	7.75	8.05
G	0.25	0.6
H	3.6	4.8
K	2.39	2.69
L	2.39	2.69
M	1.12	1.42
N	6.1	6.4

**NOTES**

1. Weight: 8g.
2. Orientation of labelling of contacts and guiding devices is not a true representation.
3. The front of the insert shall be marked with the minimum marking shown.

CODE 20 – RECEPTACLE, 2 ROWS, 96 CONTACTS

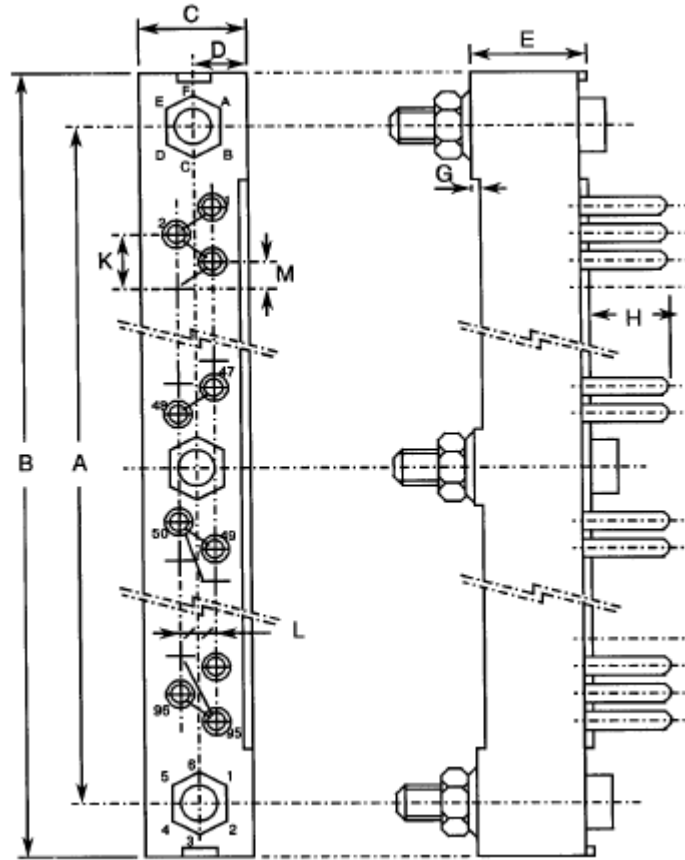

Symbol	Millimetres	
	Min	Max
A	137.01	137.31
B	144.7	145.2
C	6.3	7
D	2.8	3.05
E	7.75	8.05
G	0.25	0.6
H	3.6	4.8
K	2.39	2.69
L	2.39	2.69
M	1.12	1.42

**NOTES**

1. Weight: 9.44g.
2. Orientation of labelling of contacts and guiding devices is not a true representation.
3. The front of the insert shall be marked with the minimum marking shown.

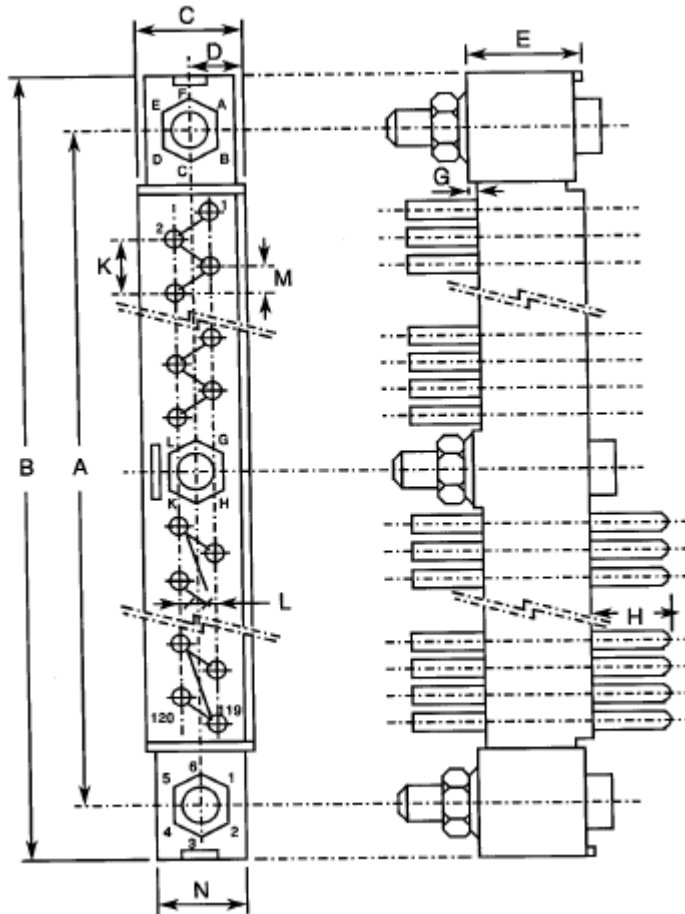
**CODE 22 – RECEPTACLE, 2 ROWS, 120 CONTACTS**

Symbol	Millimetres	
	Min	Max
A	167.49	167.79
B	175.1	175.6
C	6.3	7
D	2.8	3.05
E	7.75	8.05
G	0.25	0.6
H	3.6	4.8
K	2.39	2.69
L	2.39	2.69
M	1.12	1.42
N	6.1	6.4

**NOTES**

1. Weight: 10.8g.
2. Orientation of labelling of contacts and guiding devices is not a true representation.
3. The front of the insert shall be marked with the minimum marking shown.

**CODE 24 – RECEPTACLE, 3 ROWS, 160 CONTACTS**

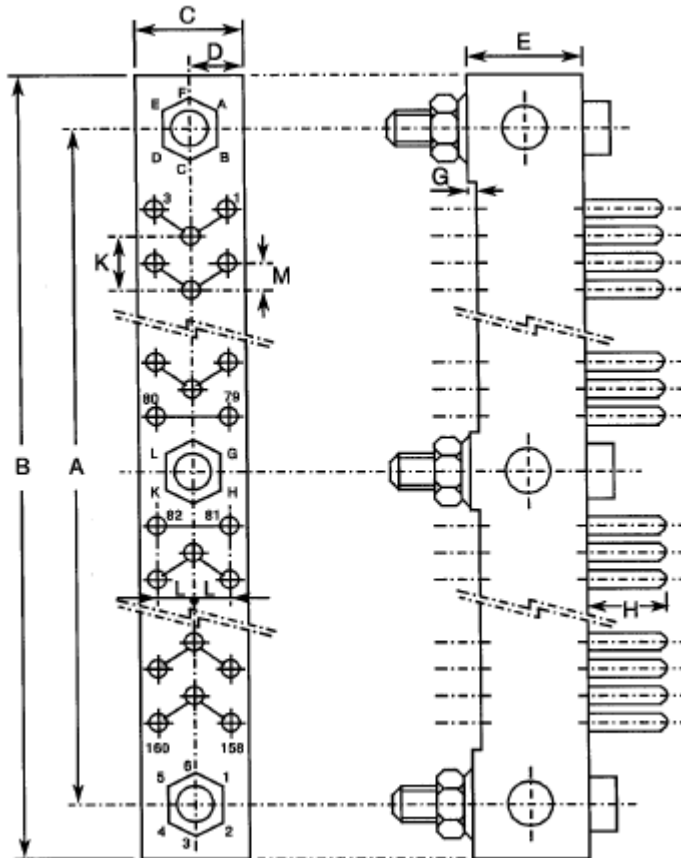

Symbol	Millimetres	
	Min	Max
A	149.71	150.01
B	157.5	158
C	9.2	9.3
D	4.55	4.75
E	7.75	8.05
G	0.25	0.6
H	3.6	4.8
K	2.39	2.69
L	2.39	2.69
M	1.12	1.42

**NOTES**

1. Weight: 12.6g.
2. Orientation of labelling of contacts and guiding devices is not a true representation.
3. The front of the insert shall be marked with the minimum marking shown.



**CODE 25 – RECEPTACLE, 3 ROWS, 160 CONTACTS**

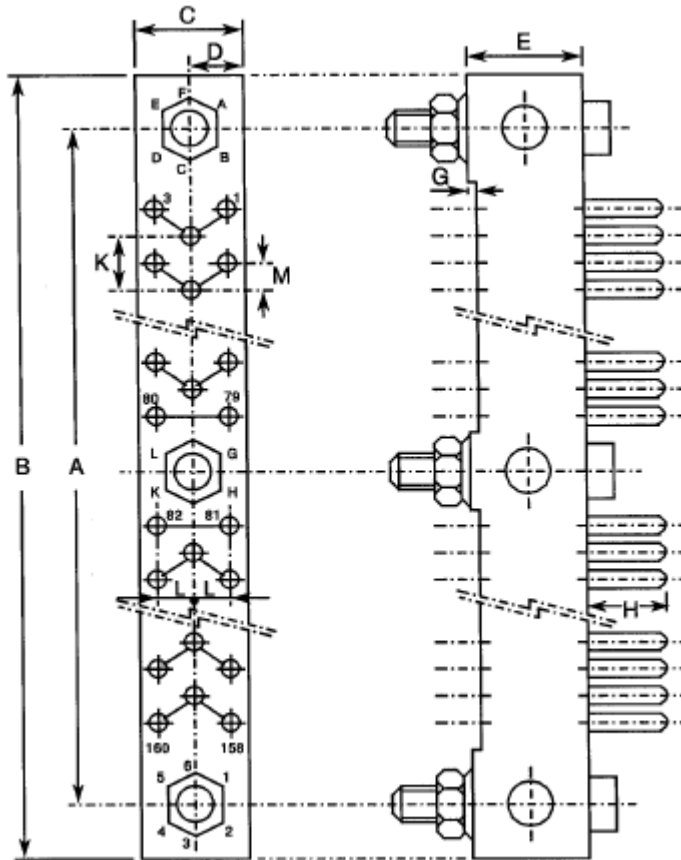

Symbol	Millimetres	
	Min	Max
A	149.71	150.01
B	157.6	158.1
C	9.2	9.3
D	4.55	4.75
E	8.8	9.1
G	0.25	0.6
H	3.6	4.8
K	2.39	2.69
L	2.39	2.69
M	1.12	1.42

**NOTES**

1. Weight: 14.8g.
2. Orientation of labelling of contacts and guiding devices is not a true representation.
3. The front of the insert shall be marked with the minimum marking shown.

CODE 56 – PLUG, 2 ROWS, 72 CONTACTS

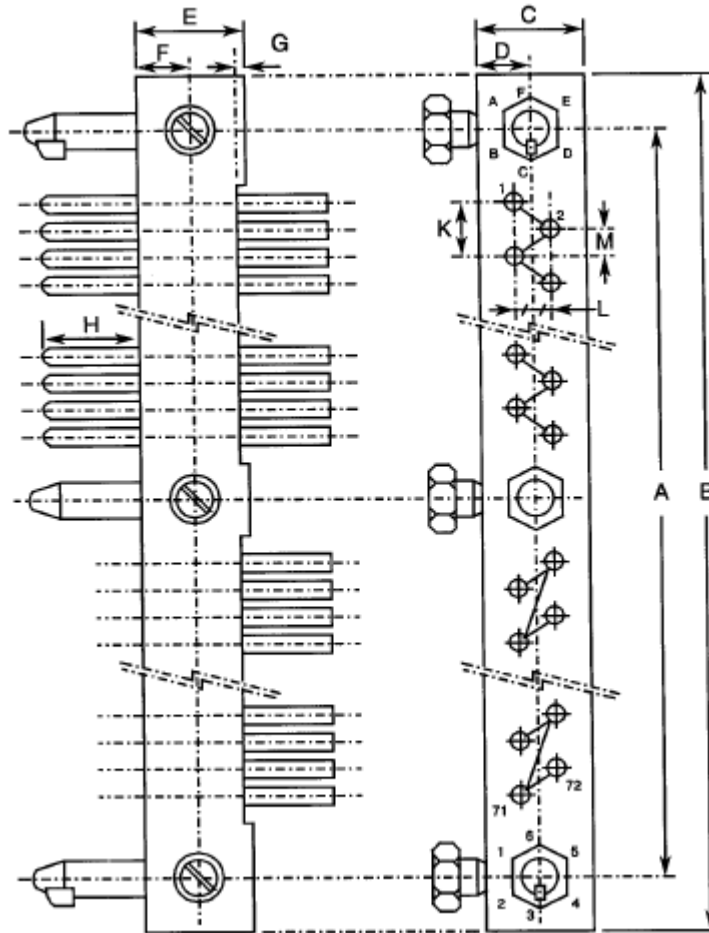

Symbol	Millimetres	
	Min	Max
A	106.53	106.83
B	114.2	114.7
C	6.3	6.4
D	3.1	3.3
E	7.75	8.05
F	3.8	4
G	0.25	0.6
H	3.6	4.8
K	2.39	2.69
L	2.39	2.69
M	1.12	1.42

**NOTES**

1. Weight: 7.1g.
2. Orientation of labelling of contacts and guiding devices is not a true representation.
3. The front of the insert shall be marked with the minimum marking shown.

CODE 57 – RECEPTACLE, 2 ROWS, 72 CONTACTS

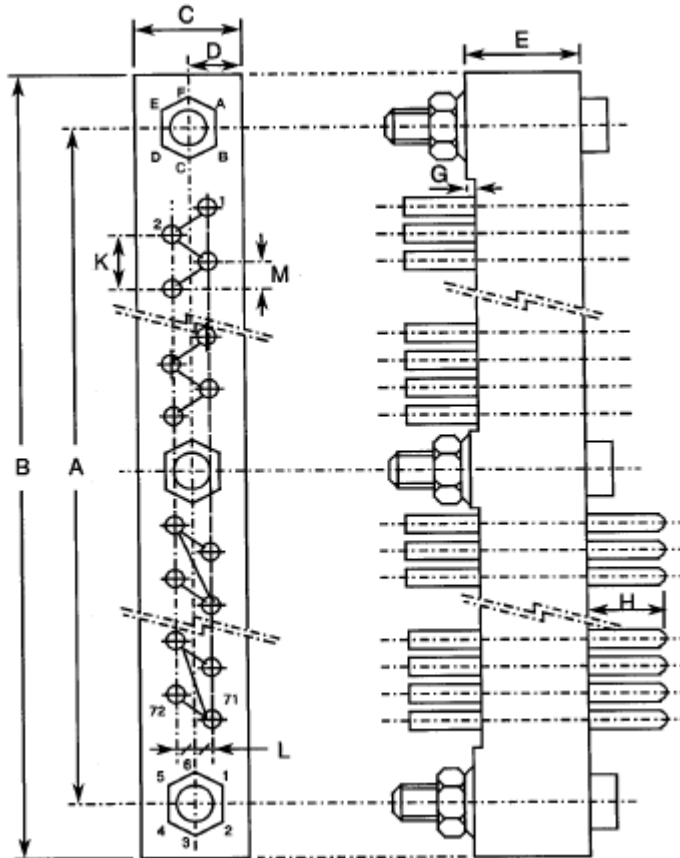

Symbol	Millimetres	
	Min	Max
A	106.53	106.83
B	114.2	114.7
C	6.3	7
D	2.8	3.05
E	7.75	8.05
G	0.25	0.6
H	3.6	4.8
K	2.39	2.69
L	2.39	2.69
M	1.12	1.42

**NOTES**

1. Weight: 8g.
2. Orientation of labelling of contacts and guiding devices is not a true representation.
3. The front of the insert shall be marked with the minimum marking shown.

CODE 58 – PLUG, 3 ROWS, 62 CONTACTS

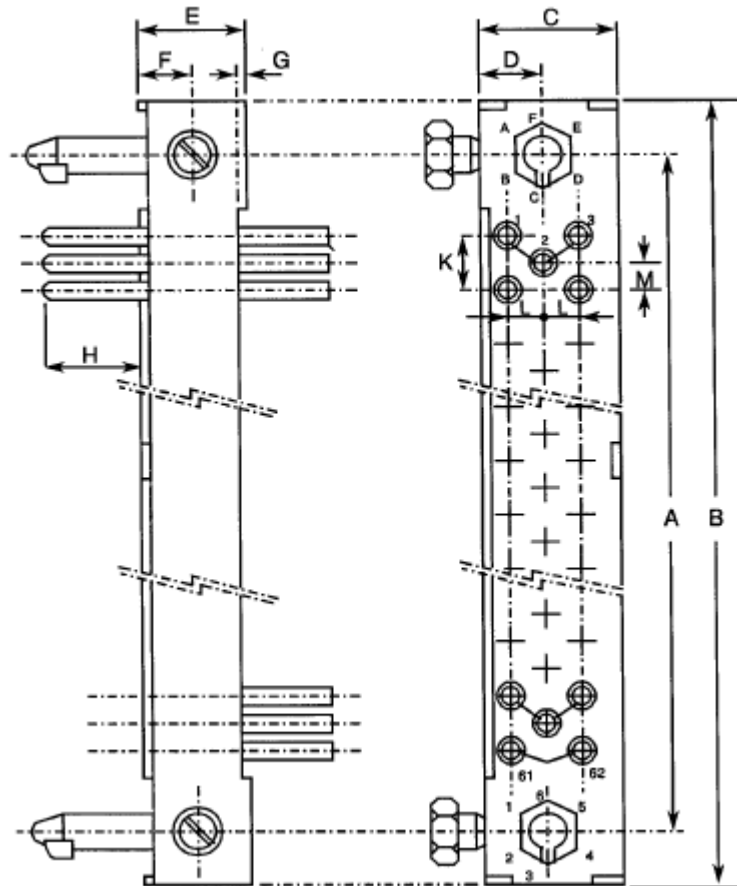

Symbol	Millimetres	
	Min	Max
A	60.81	61.11
B	68.5	69
C	9.4	9.6
D	4.35	4.55
E	7.75	8.05
F	3.8	4
G	0.25	0.6
H	3.6	4.8
K	2.39	2.69
L	2.39	2.69
M	1.12	1.42

**NOTES**

1. Weight: 6.3g.
2. Orientation of labelling of contacts and guiding devices is not a true representation.
3. The front of the insert shall be marked with the minimum marking shown.

CODE 59 – RECEPTACLE, 3 ROWS, 62 CONTACTS

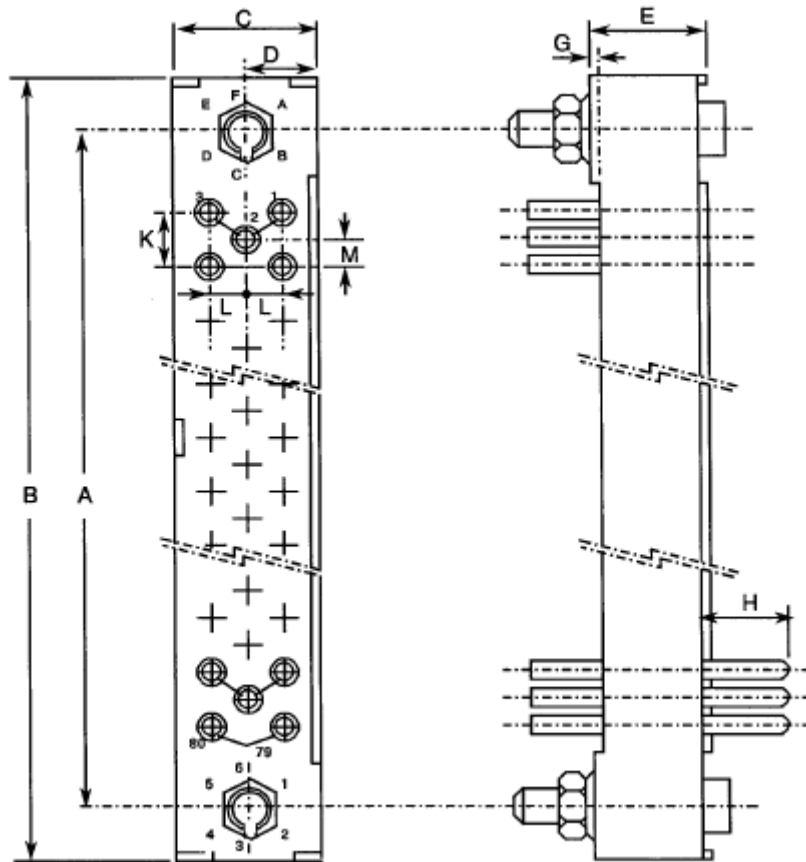

Symbol	Millimetres	
	Min	Max
A	60.81	61.11
B	68.5	69
C	9.15	9.35
D	4.05	4.25
E	7.75	8.05
G	0.25	0.6
H	3.6	4.8
K	2.39	2.69
L	2.39	2.69
M	1.12	1.42

**NOTES**

1. Weight: 6.3g.
2. Orientation of labelling of contacts and guiding devices is not a true representation.
3. The front of the insert shall be marked with the minimum marking shown.

CODE 60 – PLUG, 3 ROWS, 80 CONTACTS

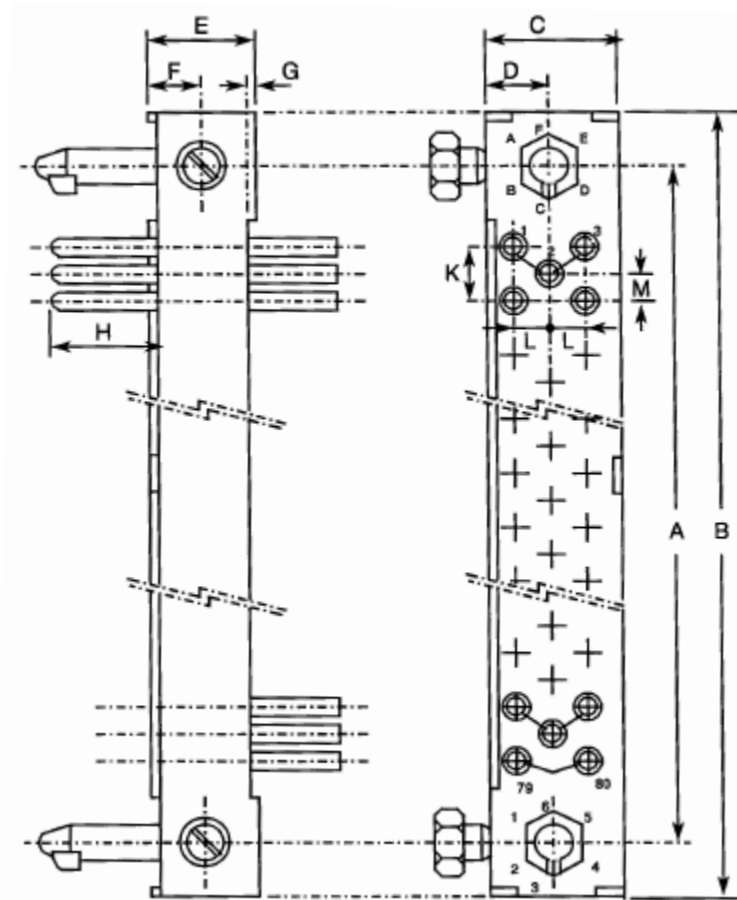

Symbol	Millimetres	
	Min	Max
A	76.05	76.35
B	83.7	84.2
C	9.4	9.6
D	4.35	4.55
E	7.75	8.05
F	3.8	4
G	0.25	0.6
H	3.6	4.8
K	2.39	2.69
L	2.39	2.69
M	1.12	1.42

**NOTES**

1. Weight: 7.7g.
2. Orientation of labelling of contacts and guiding devices is not a true representation.
3. The front of the insert shall be marked with the minimum marking shown.

CODE 61 – RECEPTACLE, 3 ROWS, 80 CONTACTS

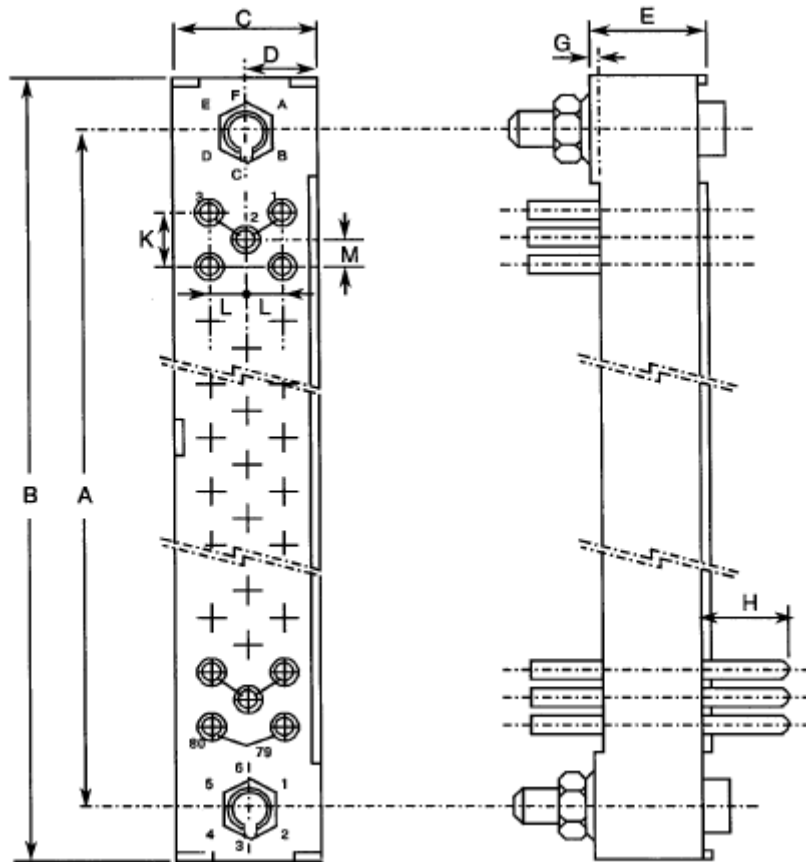

Symbol	Millimetres	
	Min	Max
A	76.05	76.35
B	83.7	84.2
C	9.15	9.35
D	4.05	4.25
E	7.75	8.05
G	0.25	0.6
H	3.6	4.8
K	2.39	2.69
L	2.39	2.69
M	1.12	1.42

**NOTES**

1. Weight: 7.4g.
2. Orientation of labelling of contacts and guiding devices is not a true representation.
3. The front of the insert shall be marked with the minimum marking shown.

CODE 62 – PLUG, 3 ROWS, 98 CONTACTS

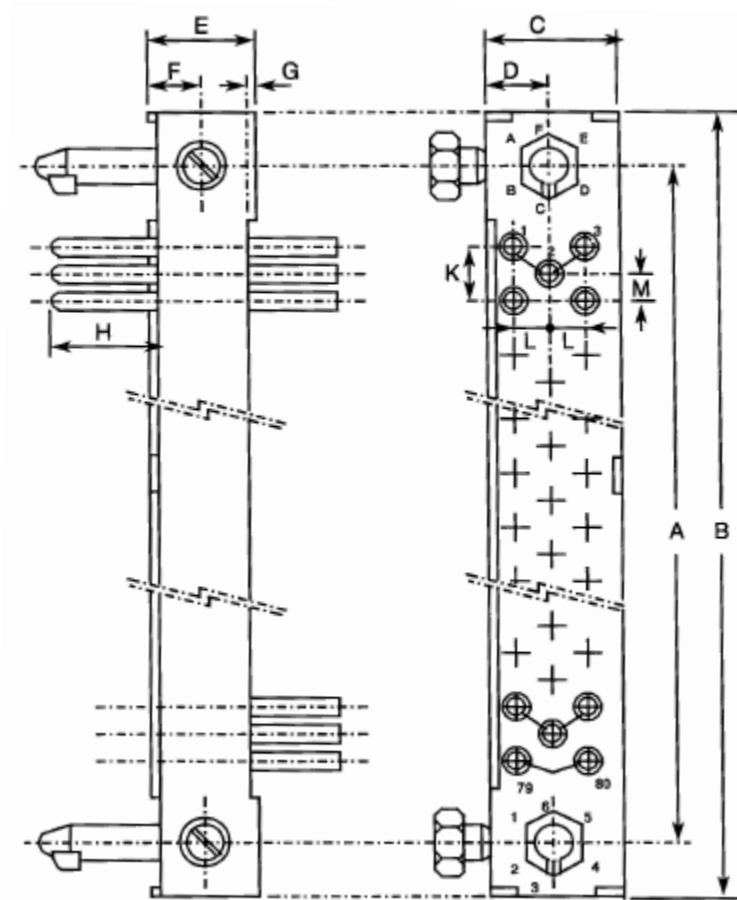

Symbol	Millimetres	
	Min	Max
A	91.29	91.59
B	99	99.5
C	9.4	9.6
D	4.35	4.55
E	7.75	8.05
F	3.8	4
G	0.25	0.6
H	3.6	4.8
K	2.39	2.69
L	2.39	2.69
M	1.12	1.42

**NOTES**

1. Weight: 8.8g.
2. Orientation of labelling of contacts and guiding devices is not a true representation.
3. The front of the insert shall be marked with the minimum marking shown.



CODE 63 – RECEPTACLE, 3 ROWS, 98 CONTACTS

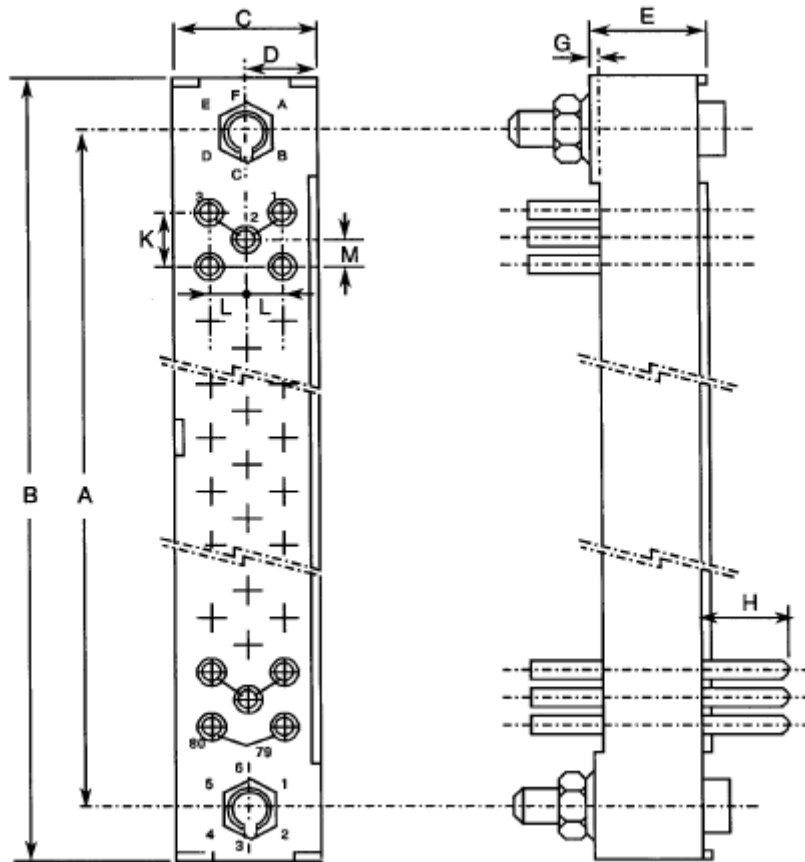

Symbol	Millimetres	
	Min	Max
A	91.29	91.59
B	99	99.5
C	9.15	9.35
D	4.05	4.25
E	7.75	8.05
G	0.25	0.6
H	3.6	4.8
K	2.39	2.69
L	2.39	2.69
M	1.12	1.42

**NOTES**

1. Weight: 8.7g.
2. Orientation of labelling of contacts and guiding devices is not a true representation.
3. The front of the insert shall be marked with the minimum marking shown.

CODE 64 – PLUG, 3 ROWS, 160 CONTACTS – HPM SHROUDED

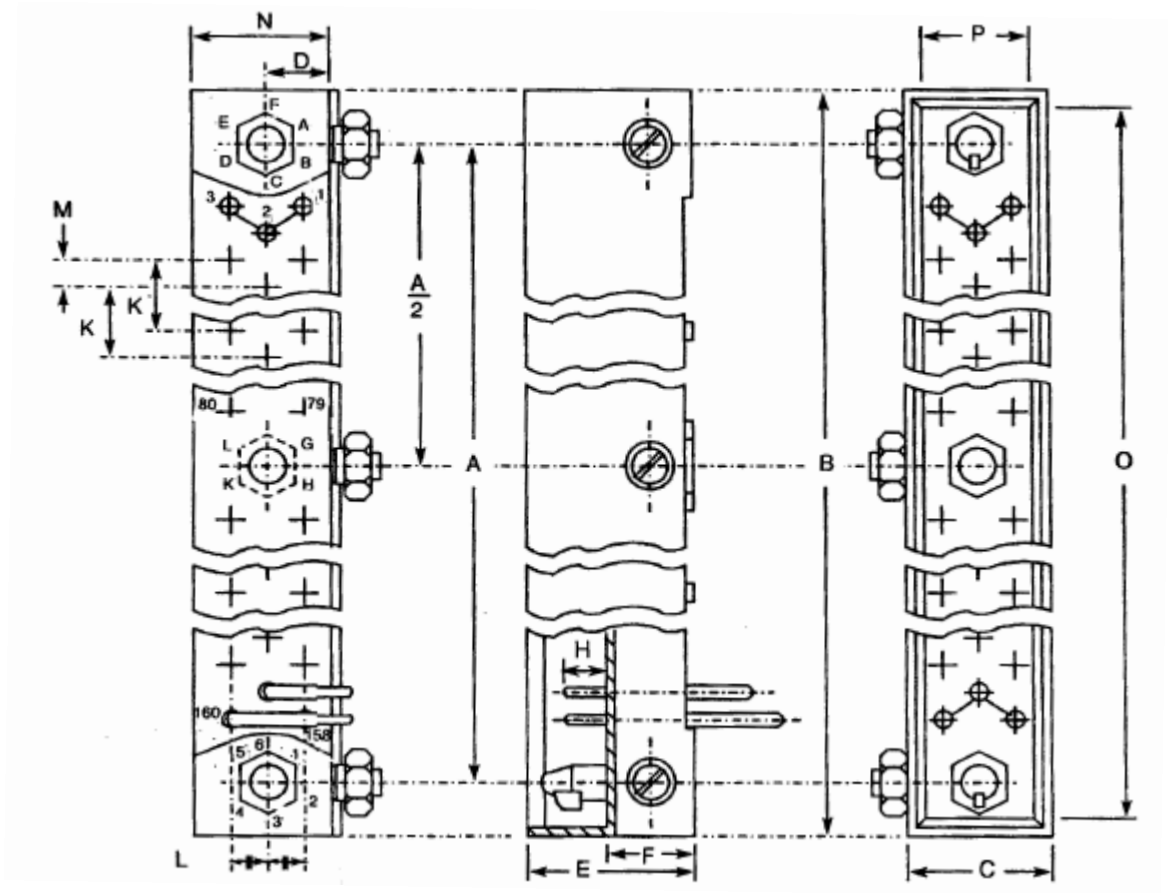

Symbol	Millimetres	
	Min	Max
A	149.71	150.01
B	160.85	161.75
C	12.15	13.05
D	4.7	4.75
E	15.05	15.35
F	7.6	8.2
H	3.6	4.8
K	2.49	2.59
L	2.49	2.59
M	1.22	1.32
N	10.65	11.85
O	158.45	158.75
P	9.75	10.05

**NOTES**

1. Weight: 23g.
2. Orientation of labelling of contacts and guiding devices is not a true representation.
3. The front of the insert shall be marked with the minimum marking shown.

**FIGURE 2(b) – GUIDING AND LOCKING DEVICES**

CODE 26

Symbol	Millimetres	
	Min	Max
A	5.6	6.1
B	2.5	3.5
C	1.4	-
D	2.45	2.55
E	3.9	4.1
H	2.45	2.55
J	13.35	14.15

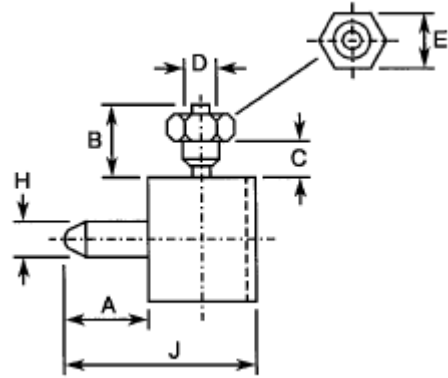

**NOTES**

1. Weight: 1.2g.
2. Torque: 11Ncm.

CODE 27

Symbol	Millimetres	
	Min	Max
A	5.6	6.1
B	2.94	4
C	1.4	-
D	2.45	2.55
E	3.9	4.1
H	2.45	2.55
J	13.35	14.15

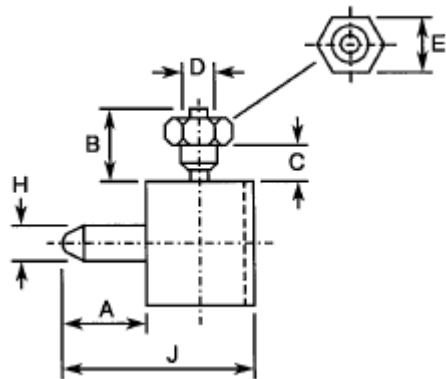

**NOTES**

1. Weight: 1.2g.
2. Torque: 11Ncm.

CODE 28

Symbol	Millimetres	
	Min	Max
A	5.6	6.1
B	6.5	7.5
D	M 2.5	
E	3.9	4.1
H	2.45	2.55
J	20.2	21.25

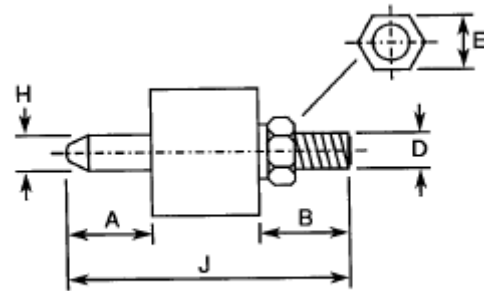

**NOTES**

1. Weight: 1.4g.
2. Torque: 14Ncm.

CODE 29

Symbol	Millimetres	
	Min	Max
A	7.35	7.65
B	6.5	7.5
D	M 2.5	
E	3.9	4.1
F	1.8	2.2
H	2.75	2.85
J	16.5	17.5
K	3.55	3.9

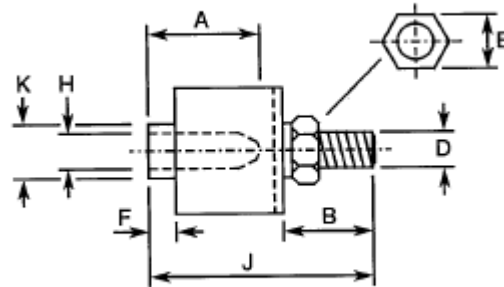

**NOTES**

1. Weight: 1.1g.
2. Torque: 14Ncm.

CODE 30

Symbol	Millimetres	
	Min	Max
A	7.75	8.05
B	7	8.2
D	M 2.5	
E	3.9	4.1
F	1.8	2.2
H	2.75	2.85
J	18.45	18.75
K	3.75	3.9

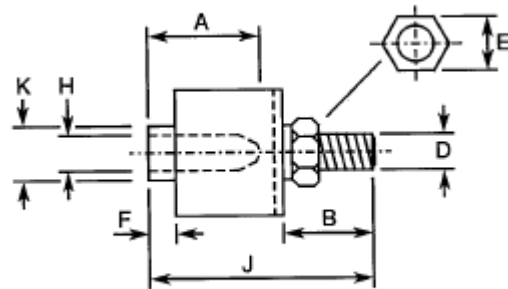

**NOTES**

1. Weight: 1.2g.
2. Torque: 14Ncm.

CODE 31

Symbol	Millimetres	
	Min	Max
A	5.6	6.1
B	5.8	6.2
C	5.8	6.2
D	0.9	1.1
E	7.8	8.2
H	2.45	2.55
J	21.1	22.5
L	3	3.3
M	M 1.6	
N	3.4	3.6
O	0.8	1.15

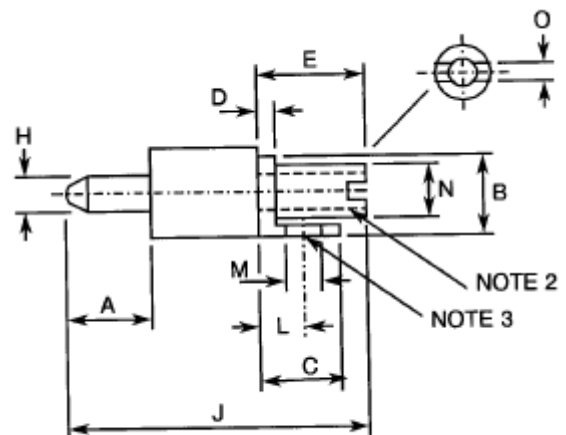

**NOTES**

1. Weight: 1.8g.
2. Torque: 14Ncm.
3. Torque: 11Ncm.

CODE 32

Symbol	Millimetres	
	Min	Max
A	7.35	7.65
B	5.8	6.2
C	5.8	6.2
D	0.9	1.1
E	7.8	8.2
F	1.8	2.2
H	2.75	2.85
J	17.5	18.5
K	3.55	3.9
L	3	3.3
M	M 1.6	
N	3.3	3.7
O	0.8	1.15

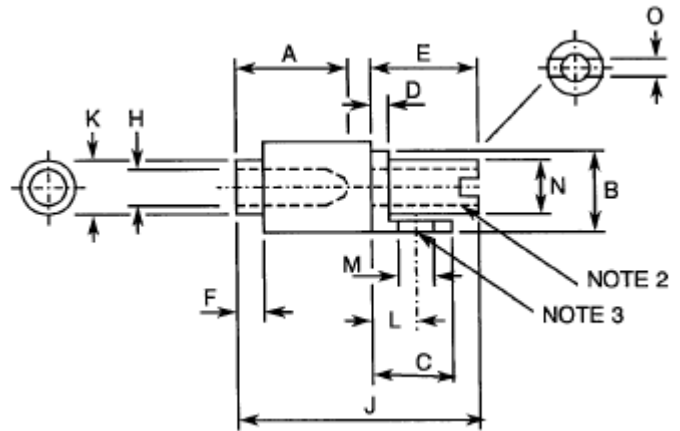

**NOTES**

1. Weight: 1.5g.
2. Torque: 14Ncm.
3. Torque: 11Ncm.

CODE 33

Symbol	Millimetres	
	Min	Max
A	5.6	6.1
B	2.5	3.5
C	1.4	-
D	2.45	2.55
E	3.9	4.1
G	0.7	1
H	2.45	2.5
I	3	3.2
J	13.35	14.15

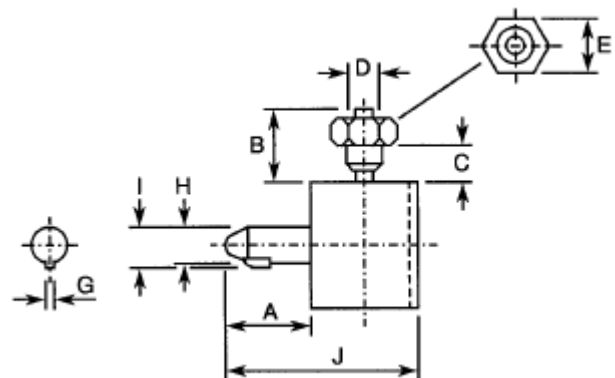

**NOTES**

1. Weight: 1.1g.
2. Torque: 11Ncm.

CODE 34

Symbol	Millimetres	
	Min	Max
A	5.6	6.1
B	2.94	4
C	1.4	-
D	2.45	2.55
E	3.9	4.1
G	0.7	1
H	2.45	2.5
I	3	3.2
J	13.35	14.15

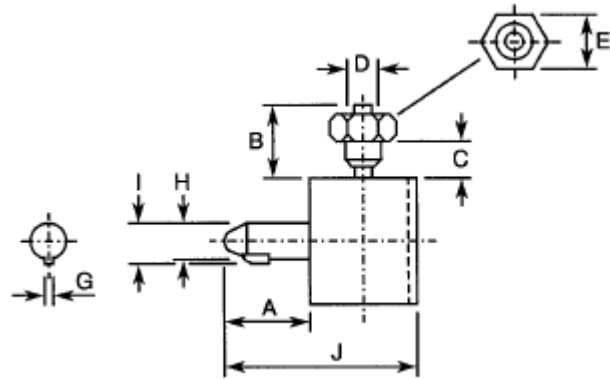

**NOTES**

1. Weight: 1.1g.
2. Torque: 11Ncm.

CODE 35

Symbol	Millimetres	
	Min	Max
A	5.6	6.1
B	6.5	7.5
D	M 2.5	
E	3.9	4.1
G	0.7	1
H	2.45	2.5
I	3	3.2
J	20.2	21.2

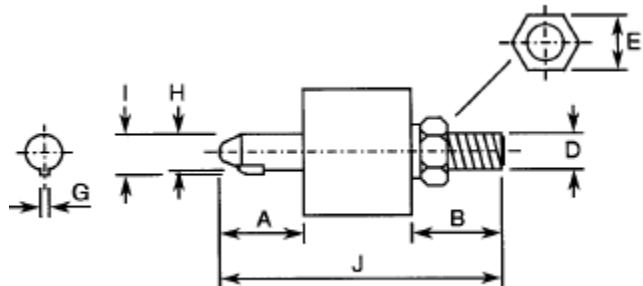

**NOTES**

1. Weight: 1.5g.
2. Torque: 14Ncm.

CODE 36

Symbol	Millimetres	
	Min	Max
A	7.35	7.65
B	6.5	7.5
D	M 2.5	
E	3.9	4.1
F	1.8	2.2
G	1.1	1.3
H	2.75	2.85
I	3.05	3.35
J	16.5	17.5
K	3.55	3.9

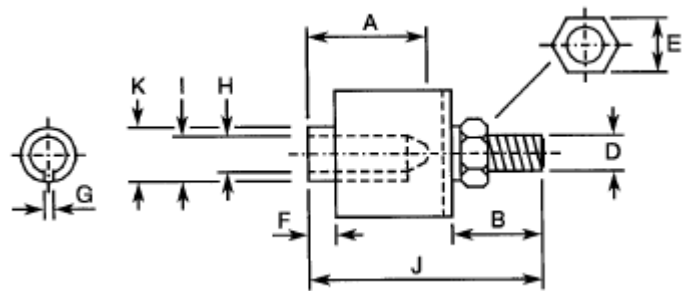

**NOTES**

1. Weight: 1g.
2. Torque: 14Ncm.

CODE 37

Symbol	Millimetres	
	Min	Max
A	7.75	8.05
B	7	8.2
D	M 2.5	
E	3.9	4.1
F	1.5	2.1
G	1.1	1.3
H	2.75	2.85
I	3.2	3.45
J	18.45	18.75
K	3.75	3.9

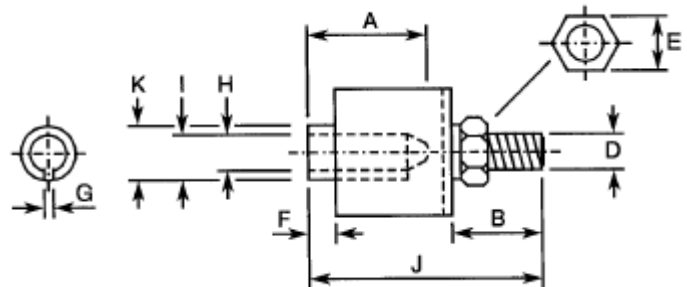

**NOTES**

1. Weight: 1.9g.
2. Torque: 14Ncm.



CODE 38

Symbol	Millimetres	
	Min	Max
A	7.75	8.05
B	7	8.2
D	M 2.5	
E	3.9	4.1
F	1.5	2.1
G	1.1	1.3
H	2.75	2.85
I	3.2	3.45
J	18.45	18.75
K	3.75	3.9

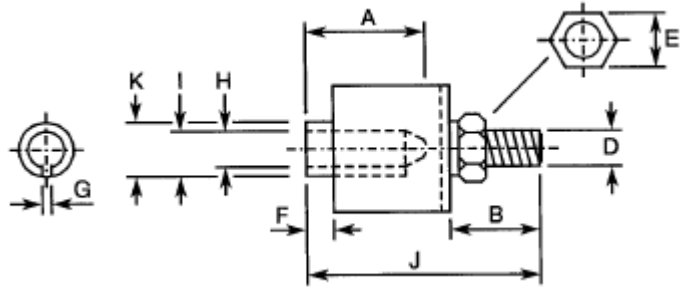

**NOTES**

1. Weight: 1.1g.
2. Torque: 14Ncm.

CODE 39

Symbol	Millimetres	
	Min	Max
A	5.3	6.1
B	7	8.2
D	M 2.5	
E	3.9	4.1
G	0.7	1
H	2.45	2.5
I	3	3.2
J	22.05	22.35

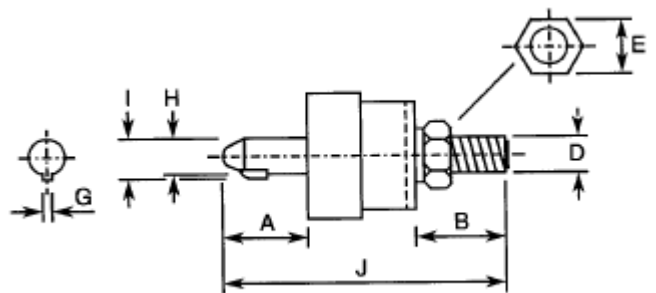

**NOTES**

1. Weight 2.3g.
2. Torque: 14Ncm.

CODE 40

Symbol	Millimetres	
	Min	Max
A	5.6	6.1
B	5.8	6.2
C	5.8	6.2
D	0.9	1.1
E	6.9	8.2
G	0.7	1
H	2.45	2.5
I	3	3.2
J	20.55	22.5
L	3	3.3
M	M 1.6	
N	3.4	3.6
O	0.8	1.15

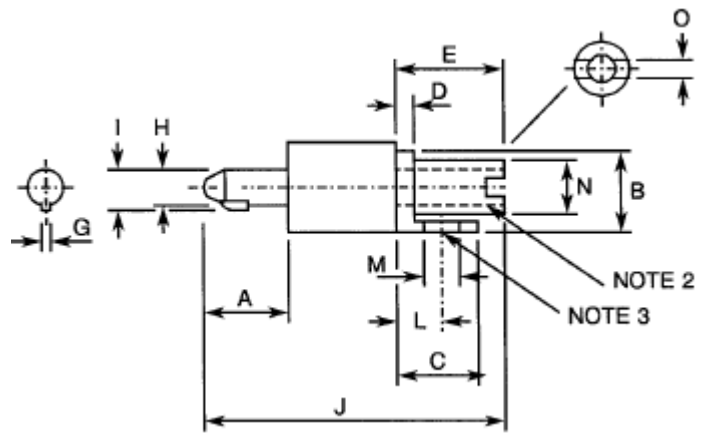

**NOTES**

1. Weight: 1.9g.
2. Torque: 14Ncm.
3. Torque: 11Ncm.

CODE 41

Symbol	Millimetres	
	Min	Max
A	7.35	7.65
B	5.8	6.2
C	5.8	6.2
D	0.9	1.1
E	7.8	8.2
F	1.8	2.2
G	1.1	1.3
H	2.75	2.85
I	3.05	3.35
J	16.55	18.5
K	3.55	3.9
L	3	3.3
M	M 1.6	
N	3.3	3.7
O	0.8	1.15

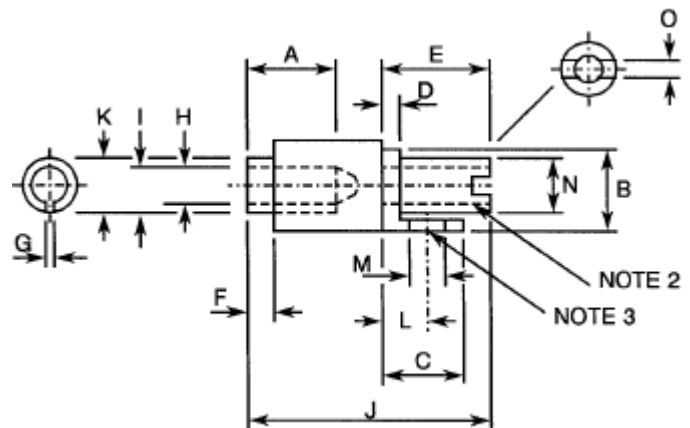

**NOTES**

1. Weight: 1.5g.
2. Torque: 14Ncm.
3. Torque: 11Ncm.

CODE 42

Symbol	Millimetres	
	Min	Max
A	6.5	7.5
B	6	7
C	3.5	-
D	3.8	4
E	5.4	5.6
F	1.6	2.9
H	M 2.5	
J	17.45	17.75
K	3.75	3.9

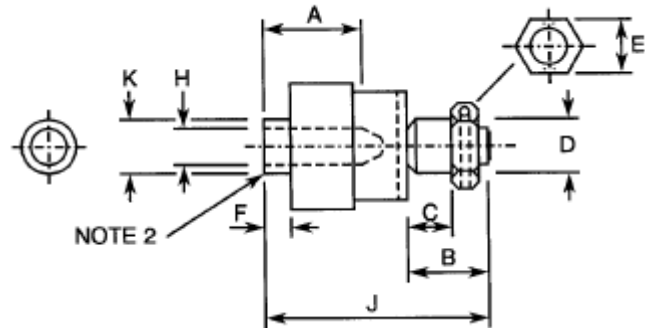

**NOTES**

1. Weight: 1.7g.
2. Torque: 14Ncm.

CODE 43

Symbol	Millimetres	
	Min	Max
A	5	5.65
B	2.94	4
C	1.4	-
D	2.45	2.55
E	3.9	4.1
H	M 2.5	
J	12.75	13.65

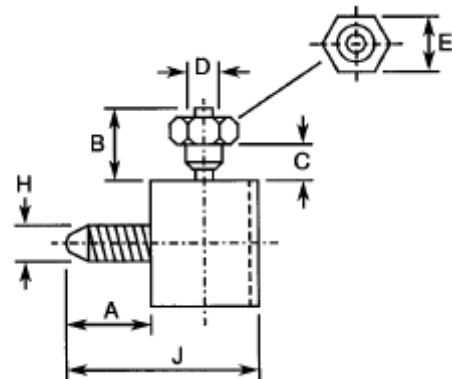

**NOTES**

1. Weight: 1.1g.
2. Torque: 11Ncm.

CODE 44

Symbol	Millimetres	
	Min	Max
A	4.7	5.5
B	7	8.2
D	M 2.5	
E	3.9	4.1
H	M 2.5	
J	21.2	22.2

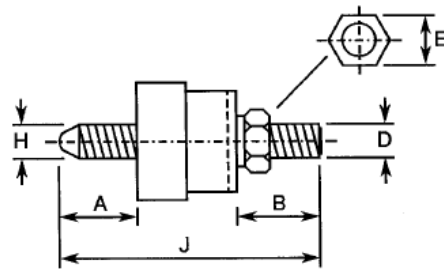

**NOTES**

1. Weight: 2.2g.
2. Torque: 14Ncm.

CODE 45

Symbol	Millimetres	
	Min	Max
A	6.5	7.5
B	6.4	7
C	3.5	-
D	3.8	4
E	5.4	5.6
F	1.9	2.9
H	M 2.5	
J	16.35	16.65
K	3.75	3.9

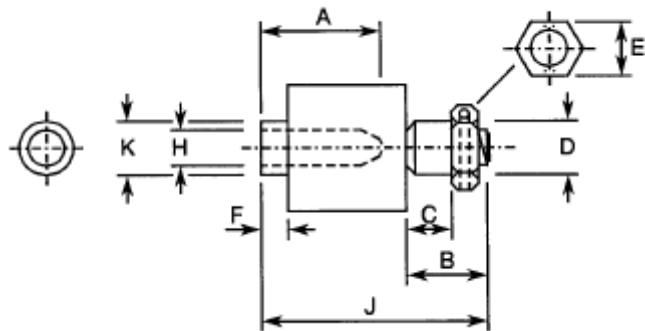

**NOTES**

1. Weight: 1.7g.
2. Torque: 14Ncm.

CODE 46

Symbol	Millimetres	
	Min	Max
A	5	5.65
B	6.75	9
D	M 2.5	
E	3.9	4.1
H	M 2.5	
J	19.95	21.85

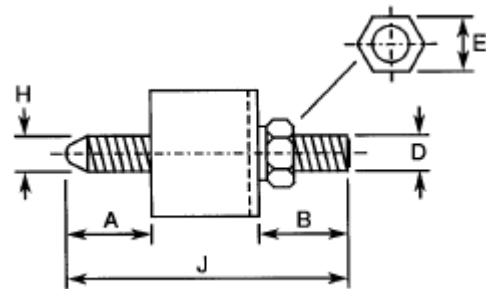

**NOTES**

1. Weight: 1.3g.
2. Torque: 14Ncm.

CODE 47

Symbol	Millimetres	
	Min	Max
F	5.7	6.5
G	0.7	1
H	2.45	2.5
I	3	3.2
J	22.2	22.5
L	-	13
M	8	9
N	5.4	5.6
O	0.4	0.6
P	M 1.6	
Q	2.9	3.1
R	11.4	12
S	1.25	1.85

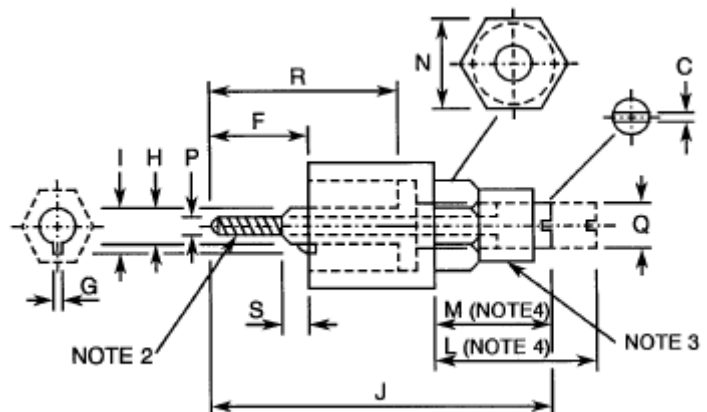

**NOTES**

1. Weight: 2g.
2. Torque: 4.6Ncm.
3. Torque: 14Ncm.
4. M = Locked, L = Unlocked.

CODE 48

Symbol	Millimetres	
	Min	Max
A	6.8	7.2
B	3.1	3.7
C	1.4	-
D	2.42	2.58
E	3.9	4.1
F	4.8	5.4
G	1.1	1.3
H	2.77	2.85
I	3.05	3.3
J	16.55	16.85
K	3.5	3.9
L	3.2	4
M	2.9	3.1
N	4.85	5.15
O	0.85	1.2
P	M 1.6	
Q	M 3	

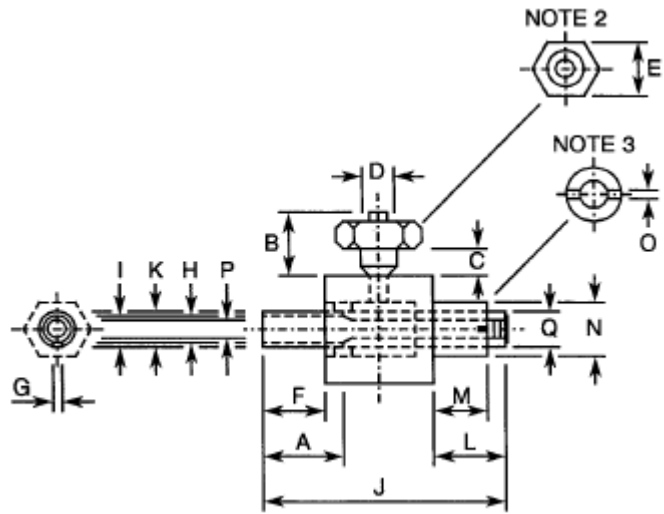

**NOTES**

1. Weight: 1.4g.
2. Torque: 8Ncm.
3. Torque: 14Ncm.

CODE 49

Symbol	Millimetres	
	Min	Max
A	6.8	7.2
B	3.1	3.7
C	1.4	-
D	2.42	2.58
E	3.9	4.1
F	4.8	5.4
G	1.1	1.3
H	2.77	2.85
I	3.05	3.3
J	16.55	16.85
K	3.5	3.9
L	3.2	4
M	2.9	3.1
N	4.85	5.15
O	0.85	1.2
P	M 1.6	
Q	M 3	

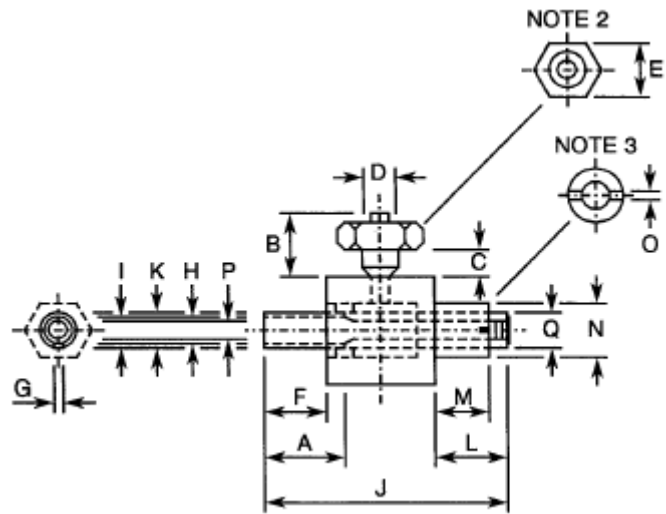

**NOTES**

1. Weight: 1.5g.
2. Torque: 14Ncm.
3. Torque: 11Ncm.

CODE 50

Symbol	Millimetres	
	Min	Max
A	6.8	7.2
F	4.8	5.4
G	1.1	1.3
H	2.77	2.85
I	3.05	3.3
J	16.55	16.85
K	3.5	3.9
L	3.2	4
M	2.9	3.1
N	4.85	5.15
O	0.85	1.2
P	M 1.6	
Q	M 3	

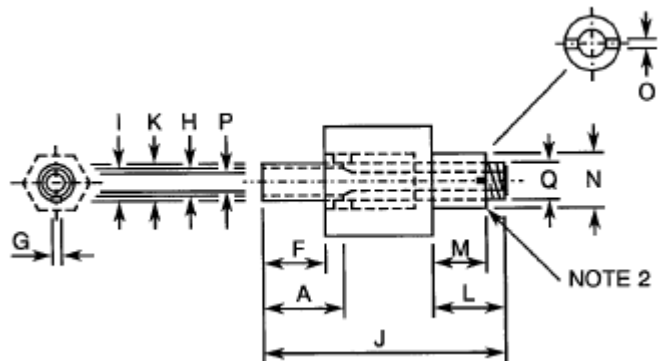

**NOTES**

1. Weight: 1.2g.
2. Torque: 14Ncm.

CODE 51

Symbol	Millimetres	
	Min	Max
A	6.3	6.7
C	11	12.8
D	3.9	4.1
E	6	6.3
F	3.8	6.2
G	1.15	1.25
I	3.1	3.25
J	25.2	25.8
N	4.9	5.1
O	2.07	2.15
P	M 2.5	
Q	7	8
R	9.5	11.5
S	0.8	1.4

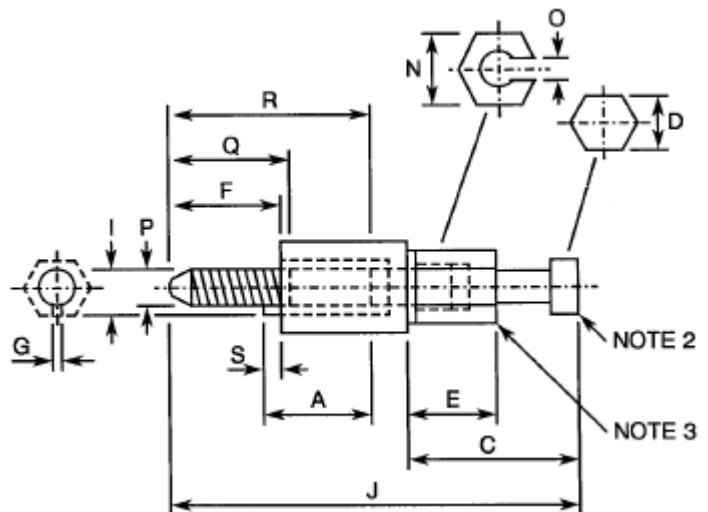

**NOTES**

1. Weight: 2g.
2. Torque: 11Ncm.
3. Torque: 15.5Ncm.



CODE 52

Symbol	Millimetres	
	Min	Max
A	7.3	7.7
B	5.8	6.2
C	5.8	6.2
D	0.9	1.1
E	3.5	4.5
F	4.5	5
G	1.3	1.5
H	2.7	2.8
I	3.15	3.3
J	18.05	19.35
K	3.75	3.85
L	3	3.3
M	M 1.6	
N	3.5	3.75
O	0.55	0.95
P	M 2.5	
Q	6	6.5

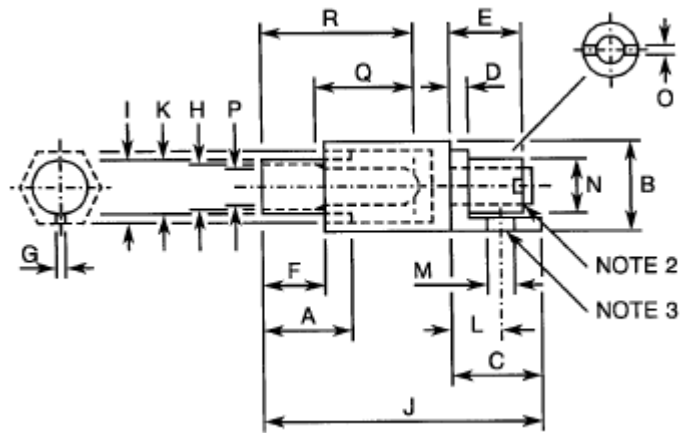

**NOTES**

1. Weight: 1.4g.
2. Torque: 14Ncm.
3. Torque: 11Ncm.

CODE 53

Symbol	Millimetres	
	Min	Max
A	6.8	7.2
F	4.8	5.4
G	1.1	1.3
H	2.77	2.85
I	3.05	3.3
J	19.55	19.85
K	3.5	3.7
L	6.2	7
M	3.35	3.7
N	4.85	5.15
O	0.8	1.15
P	M 1.6	
Q	M 3	

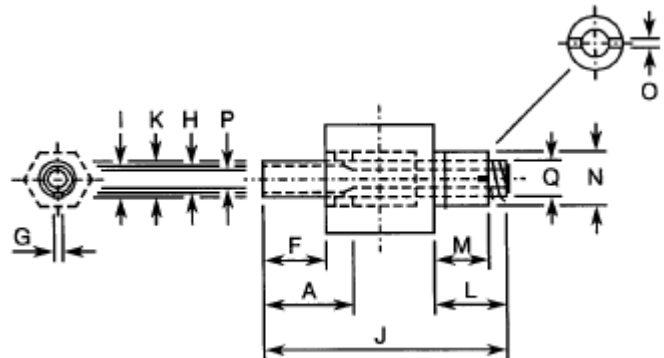

**NOTES**

1. Weight: 1.2g.
2. Torque: 14Ncm.

CODE 54

Symbol	Millimetres	
	Min	Max
A	7.35	7.65
B	6.50	7.50
C	2.10	2.50
D	3.90	4.10
F	1.8	2.2
G	1.1	1.3
H	2.75	2.85
I	3.05	3.35
J	16.5	17.5
K	3.55	3.9
L	7.3	7.7
M	4.05	4.15
N	5.8	6.35
O	0.9	1.1

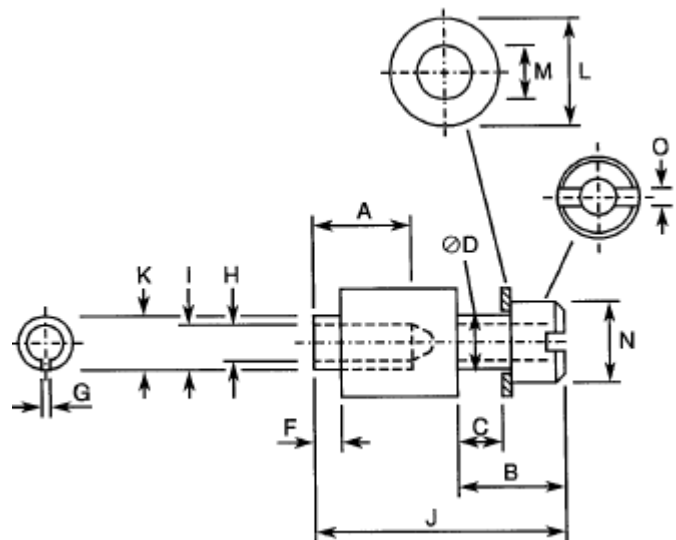

**NOTES**

1. Weight: 1.8g.
2. Torque: 14Ncm.

CODE 55

Symbol	Millimetres	
	Min	Max
A	5.6	6.1
B	6.5	7.5
C	2.1	2.5
D	3.9	4.1
G	0.7	1
H	2.45	2.5
I	3	3.2
J	20.2	21.25
L	7.3	7.7
M	4.05	4.15
N	5.8	6.35
O	0.9	1.1

**NOTES**

1. Weight: 2.2g.
2. Torque: 14Ncm.

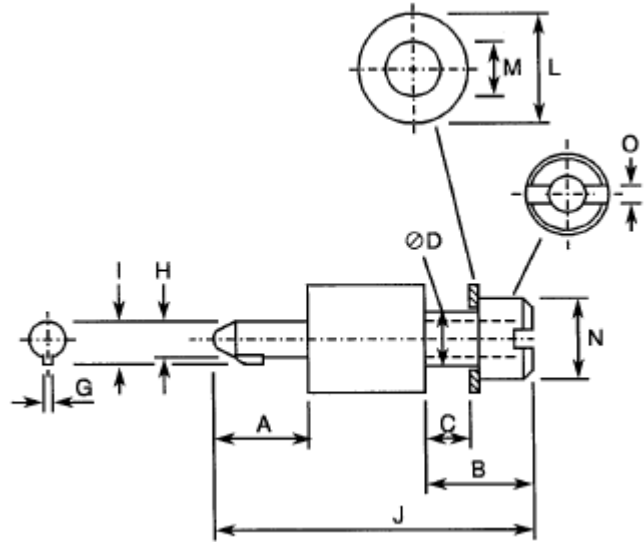

CODE 71

Symbol	Millimetres	
	Min	Max
A	5.6	6.1
B	4.2	5.3
C	1.4	-
D	2.45	2.55
E	3.9	4.1
H	2.45	2.55
J	13.35	14.15

**NOTES**

1. Weight: 1.2g.
2. Torque: 11Ncm.

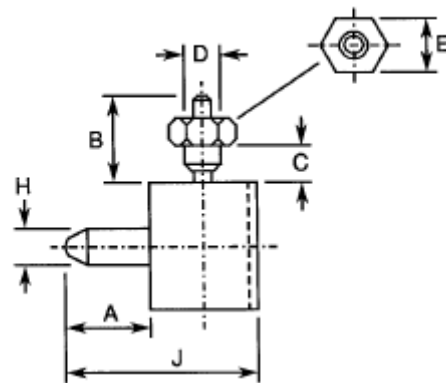

CODE 72

Symbol	Millimetres	
	Min	Max
A	5.6	6.1
B	4.2	5.3
C	1.4	-
D	2.45	2.55
E	3.9	4.1
G	0.7	1
H	2.45	2.5
I	3	3.2
J	13.35	14.15

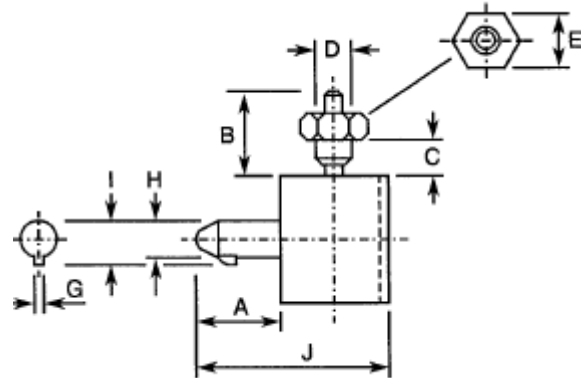

**NOTES**

1. Weight: 1.2g.
2. Torque: 11Ncm.

CODE 73

Symbol	Millimetres	
	Min	Max
A	5	5.65
B	4.2	5.3
C	1.4	-
D	2.45	2.55
E	3.9	4.1
H	M 2.5	
I	-	-
J	12.75	13.65

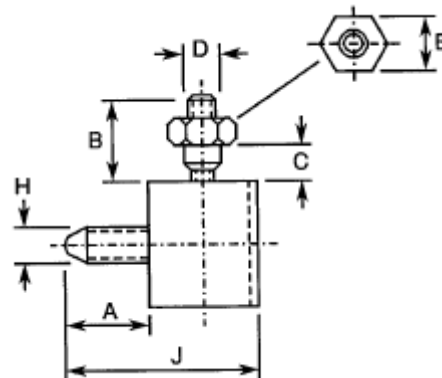

**NOTES**

1. Weight: 1.1g.
2. Torque: 11Ncm.

CODE 74

Symbol	Millimetres	
	Min	Max
A	7.35	7.65
B	7.8	8.2
C	7.8	8.2
D	1.4	1.6
E	8.3	8.7
F	1.8	2.2
G	1.1	1.3
H	2.75	2.85
I	3.05	3.35
J	18	19
K	3.55	3.9
L	4.75	5.05
M	M 1.6	
N	3.3	3.7
O	0.8	1.15

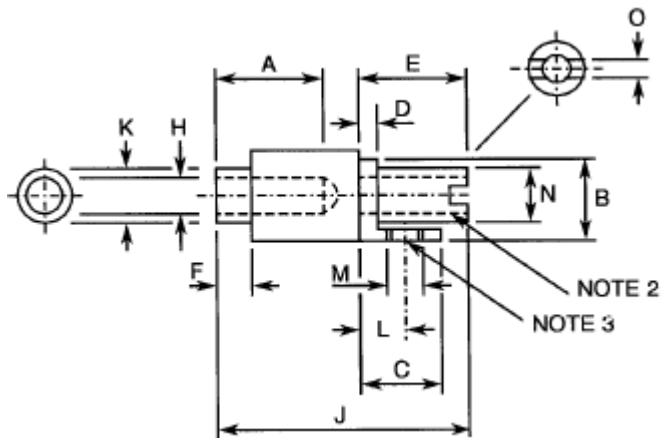

**NOTES**

1. Weight: 1.5g.
2. Torque: 14Ncm.
3. Torque: 11Ncm.

CODE 75

Symbol	Millimetres	
	Min	Max
A	7.35	7.65
B	7.8	8.2
C	7.8	8.2
D	1.4	1.6
E	8.3	8.7
F	1.8	2.2
H	2.75	2.85
J	18	19
K	3.55	3.9
L	4.75	5.05
M	M 1.6	
N	3.3	3.7
O	0.8	1.15

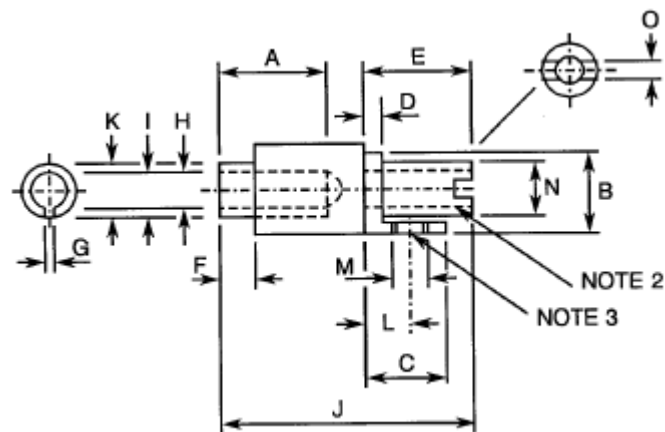

**NOTES**

1. Weight: 1.5g.
2. Torque: 14Ncm.
3. Torque: 11Ncm.

CODE 76

Symbol	Millimetres	
	Min	Max
A	5.6	6.1
B	4.88	6
C	1.4	-
D	2.45	2.55
E	3.9	4.1
G	0.7	1
H	2.45	2.5
I	3	3.2
J	13.35	14.15

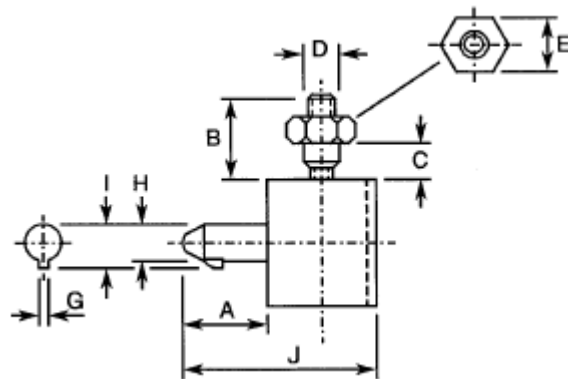

**NOTES**

1. Weight: 1.1g.
2. Torque: 11Ncm.

CODE 77

Symbol	Millimetres	
	Min	Max
A	5.6	6.1
B	4.88	6
C	1.4	-
D	2.45	2.55
E	3.9	4.1
H	2.45	2.5
J	13.35	14.15

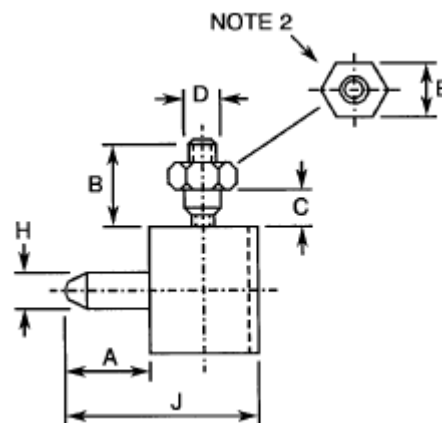

**NOTES**

1. Weight: 1.2g.
2. Torque: 11Ncm.

CODE 78

Symbol	Millimetres	
	Min	Max
A	6.5	7.5
B	4.5	7
C	3.5	-
D	3.8	4
E	4.9	5.1
F	1.15	2.9
H	M 2.5	
J	13.45	16.65
K	3.75	3.9

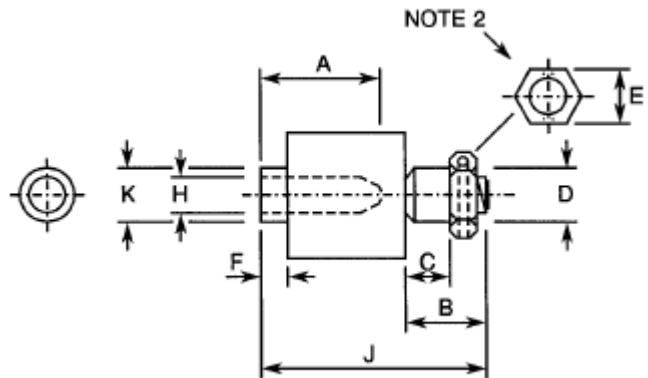

**NOTES**

1. Weight: 1.7g.
2. Torque: 14Ncm.

CODE 79

Symbol	Millimetres	
	Min	Max
A	6.8	7.2
B	4.8	5.4
C	1.4	-
D	2.42	2.58
E	3.9	4.1
F	4.8	5.4
G	1.1	1.3
H	2.77	2.85
I	3.05	3.3
J	16.55	16.85
K	3.5	3.9
L	3.2	4
M	2.9	3.1
N	4.85	5.15
O	0.85	1.2
P	M 1.6	
Q	M 3	

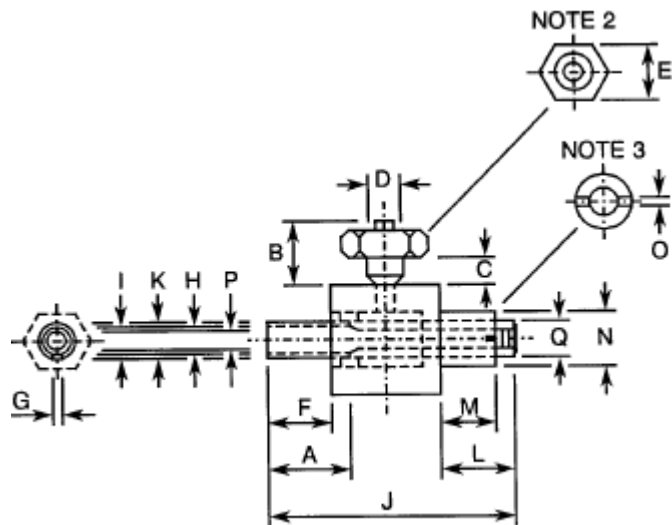

**NOTES**

1. Weight: 1.4g.
2. Torque: 8Ncm.
3. Torque: 14Ncm.

CODE 80

Symbol	Millimetres	
	Min	Max
A	7.3	7.7
C	3.5	4.5
D	M 2.5	
F	4.5	5
G	1.3	1.5
H	2.7	2.8
J	16.3	17.1
K	3.75	3.85
P	M 2.5	

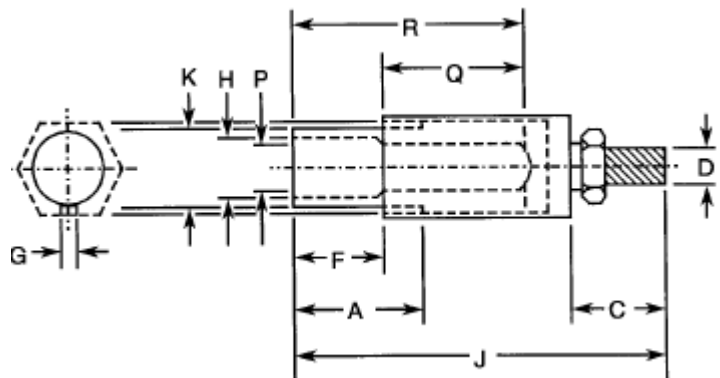

**NOTES**

1. Weight: 2g.
2. Torque: 14Ncm.

CODE 81

Symbol	Millimetres	
	Min	Max
A	6.2	7
C	9.2	10
E	5.4	5.6
G	0.7	1
H	M 1.6	
I	3	3.2
J	24	24.5
O	0.3	0.6

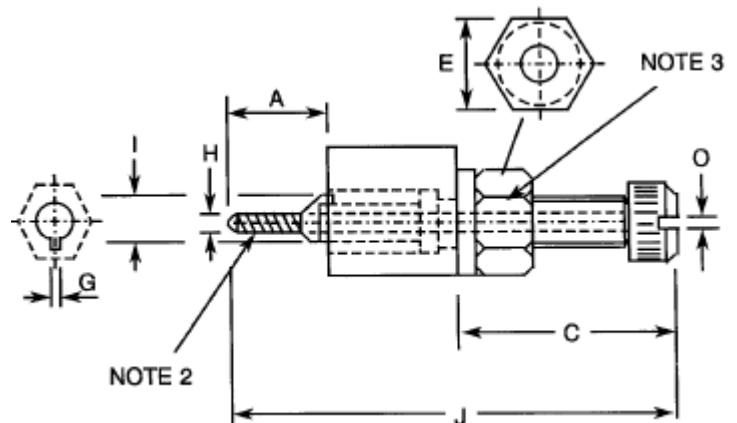

**NOTES**

1. Weight: 1.7g.
2. Torque: 4.6Ncm.
3. Torque: 14Ncm.



**FIGURE 2(c) – CONTACT MOUNTING CONFIGURATIONS**

**VIEW OF REAR PART OF CONNECTOR**

**CRIMP CONTACTS – CODE NUMBERS 04 AND 15 (2 OR 3 ROWS)**

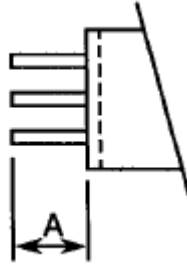

Symbol	Millimetres	
	Min	Max
A	4.15	4.9

**WIRE-WRAP CONTACTS (2 OR 3 ROWS)**

**CROSS SECTION XX**

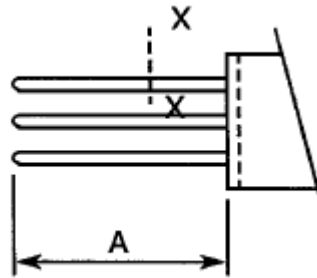
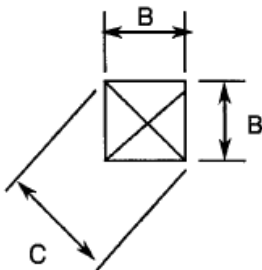

Symbol	Millimetres	
	Min	Max
A	13.5	15
B	0.6 nominal	
C	0.76	0.864

SOLDER CONTACTS

1. Insert with lateral hole for guiding and locking devices with solder right-angle contacts.

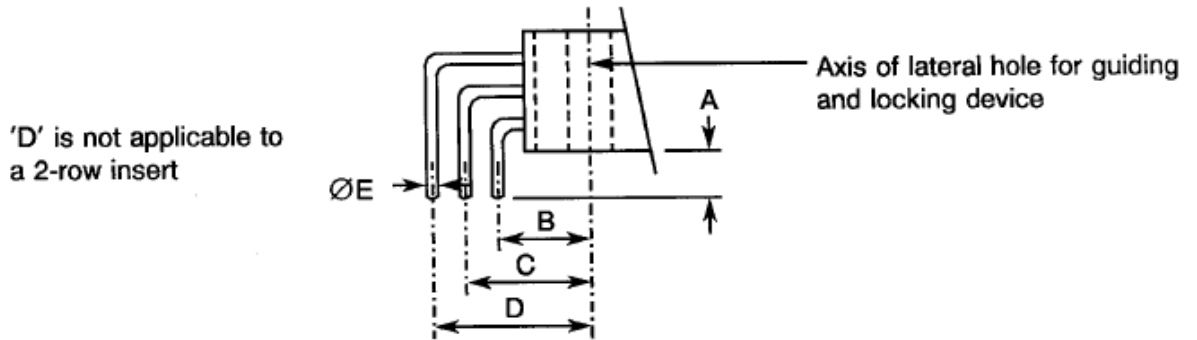

Inserts with contact code numbers 01, 02, 03, 12, 13 and 14:

Symbol	Millimetres	
	Min	Max
A	2.5	3.5
B	4.88	5.28
C	7.32	7.92
D	9.76	10.56
ØE	0.56	0.64

For inserts with contact code numbers 64, 65, 66, 68, 69 and 70, dimension 'A' shall be: 3.5 to 4.5mm.

2. Insert without lateral hole for guiding and locking devices with solder right-angle contacts.

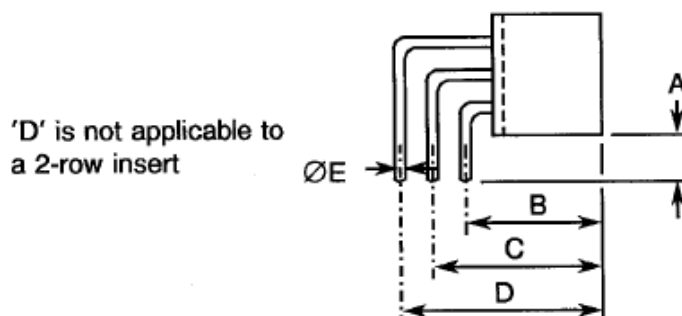

Inserts with contact code numbers 01, 02, 03, 12, 13 and 14:

Symbol	Millimetres	
	Min	Max
A	2.5	3.7
B	8.78	9.18
C	11.22	11.82
D	13.66	14.46
ØE	0.56	0.64

For inserts with contact code numbers 64, 65, 66, 68, 69 and 70, dimension 'A' shall be: 3.5 to 4.7mm.

SOLDER AND SAVER CONTACTS

3. Inserts with solder straight-through contacts (2 or 3 rows).

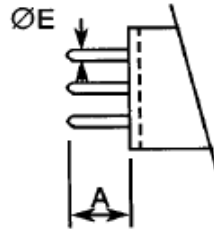

Contact Code Nos.	Symbol	Millimetres	
		Min	Max
07	A	5.3	6.15
06 and 17	A	4.5	5.35
18	A	4.25	5.1
67	A	4.15	5
06, 07, 17, 18	ØE	0.56	0.64
67	ØE	0.58	0.62

4. Inserts with bucket contacts (2 or 3 rows)

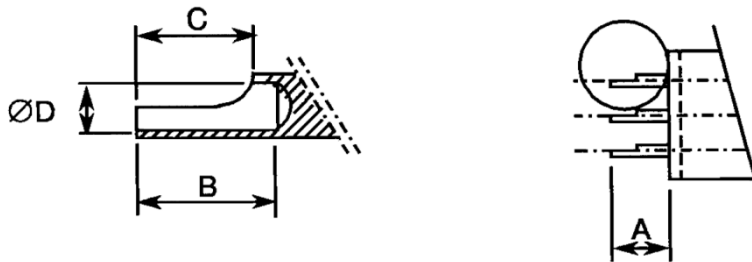

Contact Code Nos.	Symbol	Millimetres	
		Min	Max
08 and 19	A	4.75	5.65
08 and 19	B	2.8	-
08 and 19	C	2.3	2.7
08 and 19	ØD	0.98	1.04

## 4 REQUIREMENTS

### 4.1 GENERAL

The complete requirements for procurement of the connectors specified herein are stated in this specification and ESCC Generic Specification No. 3401. Deviations from the Generic Specification, applicable to this specification only, are listed in Para. 4.2.

Deviations from the applicable Generic Specification and this Detail Specification, formally agreed with specific Manufacturers on the basis that the alternative requirements are equivalent to the ESCC requirements and do not affect the components' reliability, are listed in the appendices attached to this specification..

### 4.2 DEVIATIONS FROM GENERIC SPECIFICATION

#### 4.2.1 Deviations from Special In-process Controls

None.

#### 4.2.2 Deviations from Final Production Tests (Chart II)

- (a) Para. 9.1.1.4, Mated Shell Conductivity: Not applicable.
- (b) Para. 9.4, Contact Capability: Sampling in accordance with Para. 9.6 of ESCC No. 3401.
- (c) Para. 9.5, Magnetism Level: Not applicable.
- (d) Para. 9.9, Seal Test: Not applicable.
- (e) Para. 9.3, Contact Retainer Test: Not applicable.  
Instead, the compression (25N) test of the Contact Retention (In Insert) as specified in Para. 4.3.4 of this specification shall be performed on a sample of contacts in accordance with Para. 9.6 of ESCC 3401.

#### 4.2.3 Deviations from Burn-in and Electrical Measurements (Chart III)

Not applicable.

#### 4.2.4 Deviations from Qualification Tests (Chart IV)

- (a) Para. 9.1.1.4, Mated Shell Conductivity: Not applicable.
- (b) Para. 9.9, Seal Test: Not applicable.
- (c) Para. 9.22, Corrosion: Not applicable.
- (d) Para. 9.23, Insert Retention (in shell): Not applicable.
- (e) Para. 9.24, Jackscrew Retention: Not applicable.

#### 4.2.5 Deviations from Lot Acceptance Tests (Chart V)

- (a) Para. 9.1.1.4, Mated Shell Conductivity: Not applicable.
- (b) Para. 9.9, Seal Test: Not applicable.
- (c) Para. 9.22 Corrosion: Not applicable.

### 4.3 MECHANICAL REQUIREMENTS

#### 4.3.1 Dimension Check

The dimensions of the connectors specified herein shall be verified in accordance with requirements set out in Para. 9.6 of ESCC Generic Specification No. 3401 and shall conform to those shown in Figure 2 of this specification. For procurement, dimensions to be checked are limited to:

- Figure 2(a) - Between centres of guiding or locking device. (Dimension A)
  - Dimension D (Where applicable)
- Figure 2(b) - Protrusion of locking/guiding devices.
  - Overall dimensions of locking/guiding devices
- Figure 2(c) - All dimensions.

#### 4.3.2 Weight

The maximum weight of the connectors, without contacts, and of the accessories specified herein shall be as specified in Figure 2.

#### 4.3.3 Contact Capability

See ESCC Detail Specification No. 3401/017.

#### 4.3.4 Contact Retention (In Insert)

See ESCC Detail Specification No. 3401/017.

#### 4.3.5 Mating and Unmating Forces

The forces applied for mating and unmating of the connectors shall not be more than 0.7N per contact.

#### 4.3.6 Insert Retention (In Shell)

Not applicable.

#### 4.3.7 Jackscrew Retention

Not applicable.

#### 4.3.8 Contact Insertion and Withdrawal Forces

See ESCC Detail Specification No. 3401/017.

#### 4.3.9 Engagement and Separation Forces

See ESCC Detail Specification No. 3401/017.

#### 4.3.10 Oversize Pin Exclusion

See ESCC Detail Specification No. 3401/017.

#### 4.3.11 Probe Damage

See ESCC Detail Specification No. 3401/017.

#### 4.3.12 Solderability

Size B soldering iron shall be used. See also ESCC Detail Specification No. 3401/017.

#### 4.4 MATERIALS AND FINISHES

The materials and finishes shall be as specified herein. Where a definite material is not specified, a material which will enable the connectors specified herein to meet the performance requirements of this specification shall be used. Acceptance or approval of any constituent material does not guarantee acceptance of the finished product.

##### 4.4.1 Shells

Not applicable.

##### 4.4.2 Inserts

The inserts shall be made of glass fibre-filled diallylphthalate resin.

##### 4.4.3 Contacts

As specified in ESCC Detail Specification No. 3401/017.

##### 4.4.4 Contact Retaining Clip

See ESCC Detail Specification No. 3401/017.

##### 4.4.5 Guiding and Locking Devices

Guiding and locking devices shall be made of brass (nickel-plated), stainless steel or arcap alloy.

##### 4.4.6 Magnetism Level

Not applicable.

#### 4.5 MARKING

##### 4.5.1 General

The marking of components delivered to this specification shall be in accordance with the requirements of ESCC Basic Specification No. 21700 and the following paragraphs. When the component is too small to accommodate all of the marking specified, as much as space permits shall be marked and the marking information, in full, shall accompany the component in its primary package.

The information to be marked and the order of precedence, shall be as follows:

- (a) Contact Identification.
- (b) The ESCC Component Number.
- (c) Characteristics.
- (d) Traceability Information.

##### 4.5.2 Contact Position

Contact position shall be marked on the inserts in accordance with Figure 2(a).

##### 4.5.3 The ESCC Component Number

The ESCC Component Number shall be constituted and marked as follows:

Example: 340101601B

- Detail Specification Number: 3401016
- Type Variant (see Note 1): 01
- Testing level: B

**NOTES**

1. Marking of the Type Variant is mandatory. No further reference to type variants is made in this specification.

4.5.4 Characteristics

The characteristics to be marked in the following order of precedence are:

- (a) Insert.
- (b) Contact.
- (c) Guiding and Locking Devices.

The information shall be constituted and marked as follows:

Example: 24MC352835

- Insert: 24
- Contact: MC
- Guiding and Locking Devices: 352835

4.5.4.1 *Insert*

Code numbers are specified in Figure 2(a) of this specification.

4.5.4.2 *Contacts*

Codes are specified in ESCC Detail Specification No. 3401/017.

4.5.4.3 *Guiding and Locking Devices*

Code numbers are specified in Figure 2(b) of this specification.

<u>35</u>	<u>28</u>	<u>35</u>
Guide or locking device to be placed on left side of insert (as seen from mating side)	Guide or locking device to be placed in centre of insert (if not applicable, use 00)	Guide or locking device to be placed on right side of insert (as seen from mating side)

If the Purchase Order does not specify any guiding or locking devices, the following shall be delivered:

- 2 row plugs: 332633 or 330033
- 3 row plugs: 342734 or 340034
- Receptacle: 362936 or 360036

Connector savers shall be designated by the contact code FM and codes 000000 when delivered without guiding and locking devices. Codes 000000 are only applicable to savers.

4.5.5 Traceability Information

Traceability information shall be marked in accordance with the requirements of ESCC Basic Specification No. 21700.

4.6 ELECTRICAL MEASUREMENTS

4.6.1 Electrical Measurements at Room Temperature

The parameters to be measured in respect of electrical characteristics are scheduled in Table 2. Unless otherwise specified, these measurements shall be performed at  $T_{amb} = +22 \pm 3^{\circ}C$ .

- 4.6.2 Electrical Measurements at High and Low Temperatures (Table 3)  
Not applicable.
- 4.6.3 Circuits for Electrical Measurements (Figure 4)  
Not applicable.
- 4.7 BURN-IN AND ELECTRICAL MEASUREMENTS (TABLES 4 AND 5)  
Not applicable.
- 4.8 ENVIRONMENTAL AND ENDURANCE TESTS (CHARTS IV AND V OF ESCC GENERIC SPECIFICATION NO. 3401)
- 4.8.1 Measurements and Inspections on Completion of Environmental Tests  
The parameters to be measured and inspections to be performed on completion of environmental testing shall be those specified in Table 6. Unless otherwise specified, the measurements shall be performed at  $T_{amb} = +22 \pm 3^{\circ}\text{C}$ .
- 4.8.2 Measurements and Inspections at Intermediate Points during Endurance Tests  
Not applicable.
- 4.8.3 Measurements and Inspections on Completion of Endurance Tests  
The parameters to be measured and inspections to be performed on completion of endurance tests shall be those specified in Table 6. Unless otherwise specified, the measurements shall be performed at  $T_{amb} = +22 \pm 3^{\circ}\text{C}$ .
- 4.8.4 Conditions for Operating Life Test (Part of Endurance Testing)  
Not applicable.
- 4.8.5 Electrical Circuits for Operating Life Test  
Not applicable.
- 4.8.6 Conditions for High Temperature Storage Test (Part of Endurance Testing)  
The requirements for the high temperature storage test are specified in Section 9 of ESCC Generic Specification No. 3401. The conditions for high temperature storage testing shall be the maximum storage temperature specified in Table 1(b) of this specification.



**TABLE 2 – ELECTRICAL MEASUREMENTS AT ROOM TEMPERATURE**

No.	Characteristics	Symbol	ESCC 3401 Test Method	Test Condition	Limits		Unit
					Min	Max	
1	Insulation Resistance	Ri	Para. 9.1.1.1	Para. 9.1.1.1	10000	-	MΩ
2	Voltage Proof Leakage Current (Sea Level)	I <sub>L</sub>	Para. 9.1.1.2	1200Vrms	-	1	mA
3	Mated Shell Conductivity (Voltage Drop)	Vd	Para. 9.1.1.4	Para. 9.1.1.4	Not applicable		mV

**TABLES 3, 4 AND 5**

Not applicable.

**TABLE 6 – MEASUREMENTS AND INSPECTIONS ON COMPLETION OF ENVIRONMENTAL AND ENDURANCE TESTING**

No.	ESCC Generic Spec. No. 3401		Measurements and Inspections		Symbol	Limits		Unit
	Environmental and Endurance Tests (1)	Test Method and Conditions	Identification	Conditions		Min	Max	
01	Seal Test	Para. 9.9	ESCC 3401 Para. 9.9			Not applicable		
02	Wiring	Para. 9.10	ESCC 3401/017	-	-	-	-	
03	Vibration	Para. 9.11	<b>Initial Measurements</b> Coupling Screw(s) Unlocking Torque  <b>Final Measurements</b> Full Engagement Coupling Screw(s) Unlocking Torque Drift Visual Examination	-  -  -  -	-  Δ  -  -	Record Values  -25 +25  -		%
04	Shock or Bump	Para. 9.12	Full Engagement Visual Examination	-  -	-  -	-  -	-  -	

No.	ESCC Generic Spec. No. 3401		Measurements and Inspections		Symbol	Limits		Unit
	Environmental and Endurance Tests (1)	Test Method and Conditions	Identification	Conditions		Min	Max	
05	Climatic Sequence	Para. 9.13	<b>Dry Heat</b> Insulation Resistance	Table 2 Item 1	Ri	1000	-	MΩ
			<b>Low Air Pressure</b> Voltage Proof Leakage Current	Figure 1	I <sub>L</sub>	ESCC 3401 Para. 9.13.5		
			<b>Damp Heat</b> Insulation Resistance	Immediately after test Table 2 Item 1	Ri	100	-	MΩ
			<b>Final Measurements</b> External Visual Inspection Insulation Resistance Voltage Proof Leakage Current	After 1 - 24 hrs Recovery ESCC 3401 Para. 9.7 Table 2 Item 1 Table 2 Item 2	Ri I <sub>L</sub>	ESCC 3401 Para. 9.7 Table 2 Item 1 Table 2 Item 2		
06	Plating Thickness	Para. 9.14	Thickness	-	-	ESCC 3401/017		
07	Joint Strength	Para. 9.15	ESCC 3401 Para. 9.15	-	-	ESCC 3401 Para. 9.15		
08	Rapid Change of Temperature	Para. 9.16	<b>Final Measurements</b> Visual Examination	-	-	-	-	
			Insulation Resistance Voltage Proof Leakage Current	Table 2 Item 1 Table 2 Item 2	Ri I <sub>L</sub>	Table 2 Item 1 Table 2 Item 2		
09	Contact Retention (in Insert)	Para. 9.17 & Para. 4.3.4 of spec.	Contact Displacement	-	-	ESCC 3401 Para. 9.17		
10	Endurance	Para. 9.18	<b>Initial Measurements</b> Mating/Unmating Forces	ESCC 3401/017  Table 2 Item 3	F	Para. 4.3.5 of this spec. Record Values		
			Low Level Contact Resistance		Rcl	Record Values		
			Mated Shell Conductivity		Vd	Not applicable		
			<b>Final Measurements</b> Visual Examination	-	-	-	-	Para. 4.3.5 of this spec. ESCC 3401/017
			Mating/Unmating Forces	-	F	Para. 4.3.5 of this spec.		
			Low Level Contact Resistance Drift	ESCC 3401/017	ΔRcl	ESCC 3401/017		
Mated Shell Conductivity	Table 2 Item 3	Vd	Not applicable					
Insulation Resistance	Table 2 Item 1	Ri	Table 2 Item 1					
Voltage Proof Leakage Current	Table 2 Item 2	I <sub>L</sub>	Table 2 Item 2					
11	Permanence of Marking	Para. 9.19	As applicable	-	-	-	-	
12	Mating Unmating Forces	Para. 9.20	Force	-	F	Para. 4.3.5 of this spec.		

No.	ESCC Generic Spec. No. 3401		Measurements and Inspections		Symbol	Limits		Unit
	Environmental and Endurance Tests (1)	Test Method and Conditions	Identification	Conditions		Min	Max	
13	High Temperature Storage	Para. 9.21	<b>Initial Measurements</b>					
			Low Level Contact Resistance	ESCC 3401/017	Rcl	Record Values		
			Mated Shell Conductivity	Table 2 Item 3	Vd	Not applicable		
			<b>Final Measurements</b>					
			Visual Examination	-	-	-		
			Mating/Unmating Forces		F	Para. 4.3.5 of this spec.		
			Low Level Contact Resistance Drift	ESCC 3401/017	ΔRcl	ESCC 3401/017		
			Rated Current Contact Resistance	ESCC 3401/017	Rcr	ESCC 3401/017		
			Mated Shell Conductivity	Table 2 Item 3	Vd	Not applicable		
			Insulation Resistance	Table 2 Item 1	Ri	Table 2 Item 1		
			Voltage Proof	Table 2 Item 2	IL	Table 2 Item 2		
			Leakage Current					
			Contact Retention (In Insert)	Para. 4.3.4 of this spec.	-	ESCC 3401 Para. 9.17		
14	Corrosion	Para. 9.22	Visual Examination	-	-	Not applicable		
15	Insert Retention (In Shell)	Para. 9.23 & Para. 4.3.6 of this spec.	Visual Examination	-	-	Not applicable		
16	Jackscrew Retention	Para. 9.24 & Para. 4.3.7 of this spec.	Visual Examination	-	-	Not applicable		
17	High Temperature Measurements	Para. 9.25	Insulation Resistance	Table 2 Item 1	Ri	500	-	MΩ
18	Overload Test	Para. 9.26	Internal Temperature	-	T	-	+100	°C
			Rated Current	ESCC 3401/017	Rcr	ESCC 3401/017		
			Contact Resistance					
			Mated Shell Conductivity	Table 2 Item 3	Vd	Not applicable		
			Insulation Resistance	Table 2 Item 1	Ri	Table 2 Item 1		
Voltage Proof	Table 2 Item 2	IL	Table 2 Item 2					
Leakage Current								
19	Maintenance Aging	Para. 9.27	Visual Examination	-	-	-	-	
			Contact Retention	Para. 4.3.4 of this spec.	-	ESCC 3401 Para. 9.17		
			Contact Insertion & Withdrawal Forces	Para. 4.3.8 of this spec.	-	Para. 4.3.8		
20	Engage/Separation Forces	Para. 9.28 & Para. 4.3.9 of this spec.	Force	-	-	Para. 4.3.9		
21	Oversize Pin Exclusion	Para. 9.29 & Para. 4.3.10 of this spec.	-	-	-	ESCC 3401 Para. 9.29		
22	Probe Damage	Para. 9.30 & Para. 4.3.11 of this spec.	Contact Separation Force	Para. 4.3.9 of this spec.	-	Para. 4.3.9		
23	Solderability	Para. 9.31 & Para. 4.3.12 of this spec.	-	-	-	ESCC 3401 Para. 9.31		



**NOTES**

1. The tests in this Table refer to either Chart IV or V and shall be used as applicable.