



**RELAY, ELECTROMAGNETIC, LATCHING, 28VDC,
1A, 2PDT, 1/6 CRYSTAL CAN**

ESCC Detail Specification No. 3602/019

Issue 5	October 2015
---------	--------------



LEGAL DISCLAIMER AND COPYRIGHT

European Space Agency, Copyright © 2015. All rights reserved.

The European Space Agency disclaims any liability or responsibility, to any person or entity, with respect to any loss or damage caused, or alleged to be caused, directly by the use and application of this ESCC publication.

This publication, without prior permission of the European Space Agency and provided it is not used for a commercial purpose, may be:

- copied in whole, in any medium, without alteration or modification.
- copied in part, in any medium, provided that the ESCC document identification, comprising the ESCC symbol, document number and document issue, is removed.

DOCUMENTATION CHANGE NOTICE

(Refer to <https://escies.org> for ESCC DCR content)

DCR No.	CHANGE DESCRIPTION
947	Specification updated to incorporate technical changes per DCR.

TABLE OF CONTENTS

1	GENERAL	5
1.1	SCOPE	5
1.2	APPLICABLE DOCUMENTS	5
1.3	TERMS, DEFINITIONS, ABBREVIATIONS, SYMBOLS AND UNITS	5
1.4	THE ESCC COMPONENT NUMBER AND COMPONENT TYPE VARIANTS	5
1.4.1	The ESCC Component Number	5
1.4.1.1	Characteristics and/or Ratings Codes	5
1.4.2	Component Type Variants and Range of Components	6
1.5	MAXIMUM RATINGS	7
1.6	PHYSICAL DIMENSIONS AND TERMINAL IDENTIFICATION	8
1.6.1	Plain Case (No Mount) and Solder Pin Terminals (Variant 01)	8
1.6.2	Plain Case (No Mount) and Long Lead Terminals (Variant 02)	9
1.6.3	Raised Vertical Flange Mount and Solder Pin Terminals (Variant 04)	10
1.6.4	Raised Vertical Flange Mount and Long Lead Terminals (Variant 05)	11
1.6.5	Raised Vertical Flange Mount and Solder Hook Terminals (Variant 06)	12
1.6.6	Flush Vertical Flange Mount and Solder Pin Terminals (Variant 07)	13
1.6.7	Horizontal Flange Mount and Long Lead Terminals (Variant 10)	14
1.6.8	Horizontal Flange Mount and Solder Hook Terminals (Variant 11)	15
1.7	FUNCTIONAL DIAGRAM	16
1.8	MATERIALS AND FINISHES	16
1.8.1	Case	16
1.8.2	Terminals	16
2	REQUIREMENTS	16
2.1	GENERAL	16
2.1.1	Deviations from the Generic Specification	16
2.2	MARKING	16
2.3	TERMINAL STRENGTH	17
2.4	ELECTRICAL MEASUREMENTS AT ROOM, HIGH AND LOW TEMPERATURES	17
2.4.1	Room Temperature Electrical Measurements	17
2.4.2	High and Low Temperatures Electrical Measurements	18
2.4.3	Notes to Electrical Measurements Tables	18
2.5	PARAMETER DRIFT VALUES	19
2.6	INTERMEDIATE AND END-POINT ELECTRICAL MEASUREMENTS	19
2.7	RUN-IN CONDITIONS	24
	APPENDIX A	25

1 GENERAL

1.1 SCOPE

This specification details the ratings, physical and electrical characteristics, and test and inspection data for the component type variants and/or the range of components specified below. It supplements the requirements of, and shall be read in conjunction with, the ESCC Generic Specification listed under Applicable Documents.

1.2 APPLICABLE DOCUMENTS

The following documents form part of this specification and shall be read in conjunction with it:

- (a) ESCC Generic Specification No. 3602.

1.3 TERMS, DEFINITIONS, ABBREVIATIONS, SYMBOLS AND UNITS

For the purpose of this specification, the terms, definitions, abbreviations, symbols and units specified in ESCC Basic Specification No. 21300 shall apply.

1.4 THE ESCC COMPONENT NUMBER AND COMPONENT TYPE VARIANTS

1.4.1 The ESCC Component Number

The ESCC Component Number shall be constituted as follows:

Example: 36020190126V

- Detail Specification Reference: 3602019
- Component Type Variant Number: 01 (as required)
- Characteristic code: Rated Coil Voltage (26.5Vdc): 26V (as required)

1.4.1.1 *Characteristics and/or Ratings Codes*

Characteristics and/or ratings to be codified as part of the ESCC Component Number shall be as follows:

- (a) Rated Coil Voltage expressed by means of the following codes:

Rated Coil Voltage (Vdc)	Code
26.5	26V
12	12V
6	6V

1.4.2 Component Type Variants and Range of Components

The component type variants and range of components applicable to this specification are as follows:

Variant Number	Case and Terminal Description (Note 1)	Rated Coil Voltage (Vdc)	Weight max (g)
01	Plain Case (No Mount) Solder Pin Terminals	26.5, 12, 6	2.6
02	Plain Case (No Mount) Long Lead Terminals	26.5, 12, 6	3.2
04	Raised Vertical Flange Mount Solder Pin Terminals	26.5, 12, 6	2.9
05	Raised Vertical Flange Mount Long Lead Terminals	26.5, 12, 6	3.5
06	Raised Vertical Flange Mount Solder Hook Terminals	26.5, 12, 6	2.9
07	Flush Vertical Flange Mount Solder Pin Terminals	26.5, 12, 6	2.9
10	Horizontal Flange Mount Long Lead Terminals	26.5, 12, 6	3.5
11	Horizontal Flange Mount Solder Hook Terminals	26.5, 12, 6	2.9

NOTES:

1. See Physical Dimensions and Terminal Identification.

1.5 MAXIMUM RATINGS

The maximum ratings shall not be exceeded at any time during use or storage.

Maximum ratings shall only be exceeded during testing to the extent specified in this specification and when stipulated in Test Methods and Procedures of the ESCC Generic Specification.

Characteristics	Symbols	Maximum Ratings	Units	Remarks
Coil Voltage Range	V_{CR}	25 to 32 11 to 15 5.5 to 7.5	Vdc	Rated Coil Voltage: 26.5Vdc Rated Coil Voltage: 12Vdc Rated Coil Voltage: 6Vdc
Rated Resistive Load Contact Current	I_{CR}	1	A	28Vdc resistive Note 1
Rated Inductive Load Contact Current	I_{CL}	200	mA	28Vdc inductive Inductance: 320mH Note 1
Overload Current	$I_{OVERLOAD}$	2	A	28Vdc resistive
Operating Temperature Range	T_{op}	-65 to +125	°C	T_{amb}
Storage Temperature Range	T_{stg}	-65 to +125	°C	T_{amb}
Soldering Temperature	T_{sol}	+260	°C	Note 2

NOTES:

1. Relays should not be used in change-over mode where the potential difference between stationary contacts is greater than 10V and the switched current is greater than 100mA.
2. Duration 10 seconds maximum at a distance not less than 1.5mm from the device body. The same terminal shall not be resoldered until 3 minutes have elapsed.

1.6 PHYSICAL DIMENSIONS AND TERMINAL IDENTIFICATION

1.6.1 Plain Case (No Mount) and Solder Pin Terminals (Variant 01)

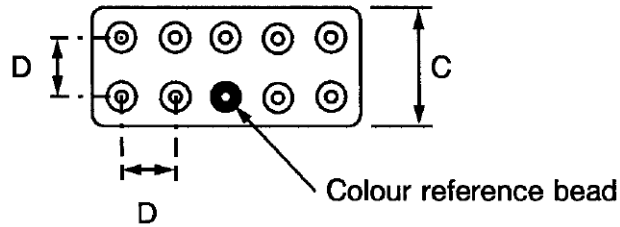
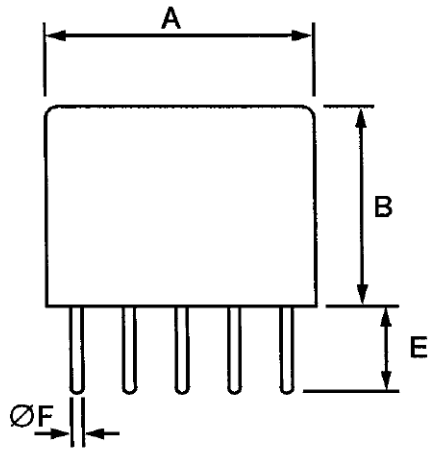

Symbols	Dimensions (mm)	
	Min	Max
A	-	13
B	-	10.4
C	-	6.1
D	2.41	2.67
E	4.4	5.2
ØF	0.45	0.55

NOTES:

- Terminal identification is specified by reference to the colour reference bead. See Functional Diagram.

1.6.2 Plain Case (No Mount) and Long Lead Terminals (Variant 02)

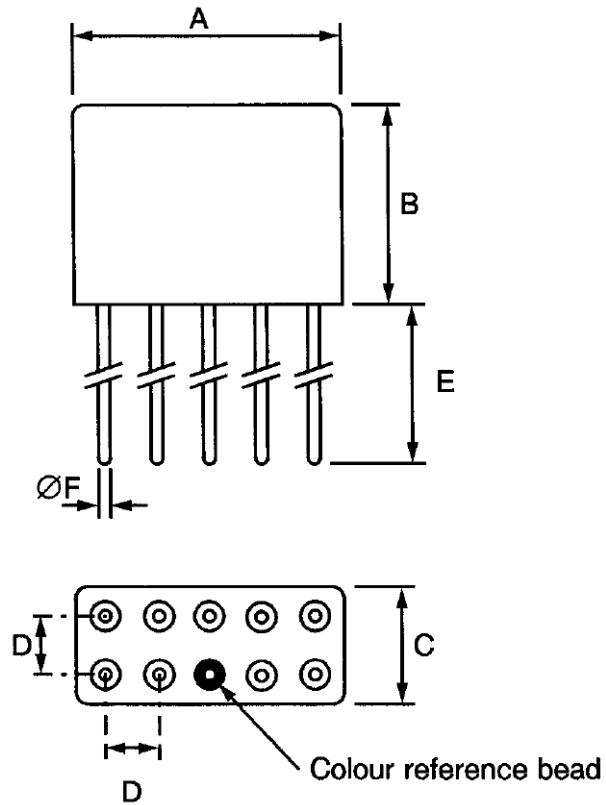

Symbols	Dimensions (mm)	
	Min	Max
A	-	13
B	-	10.4
C	-	6.1
D	2.41	2.67
E	37	39
ØF	0.45	0.55

NOTES:

- Terminal identification is specified by reference to the colour reference bead. See Functional Diagram.

1.6.3 Raised Vertical Flange Mount and Solder Pin Terminals (Variant 04)

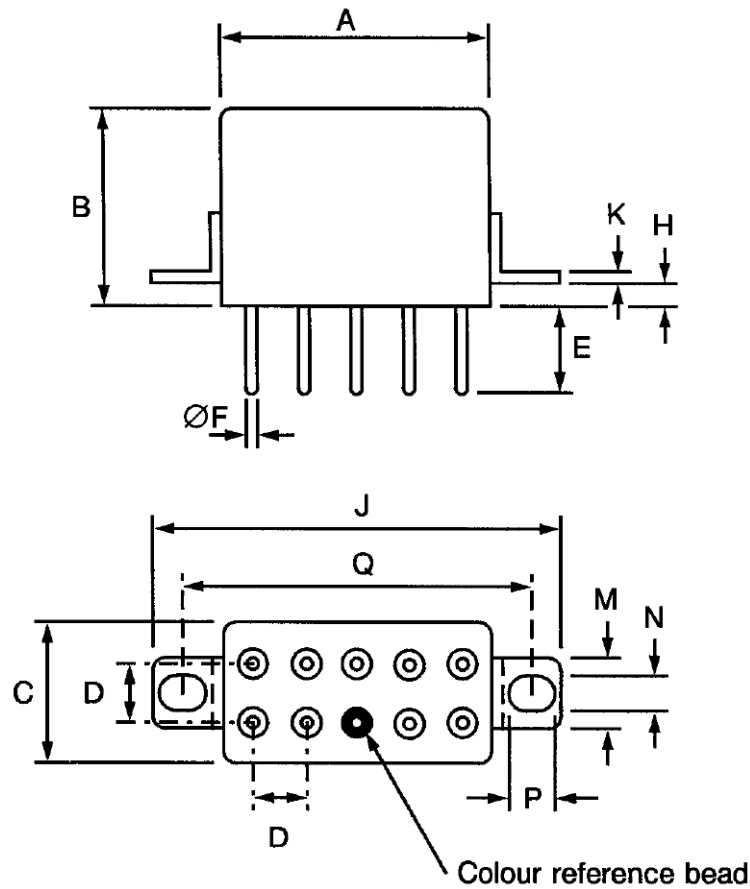

Symbols	Dimensions (mm)	
	Min	Max
A	-	13
B	-	10.4
C	-	6.1
D	2.41	2.67
E	4.4	5.2
ØF	0.45	0.55
H	3	3.4
J	-	22.85
K	0.3	0.5
M	4.5	4.9
N	2.15	2.65
P	3.1	3.3
Q	17.35	18.35

NOTES:

- Terminal identification is specified by reference to the colour reference bead. See Functional Diagram.

1.6.4 Raised Vertical Flange Mount and Long Lead Terminals (Variant 05)

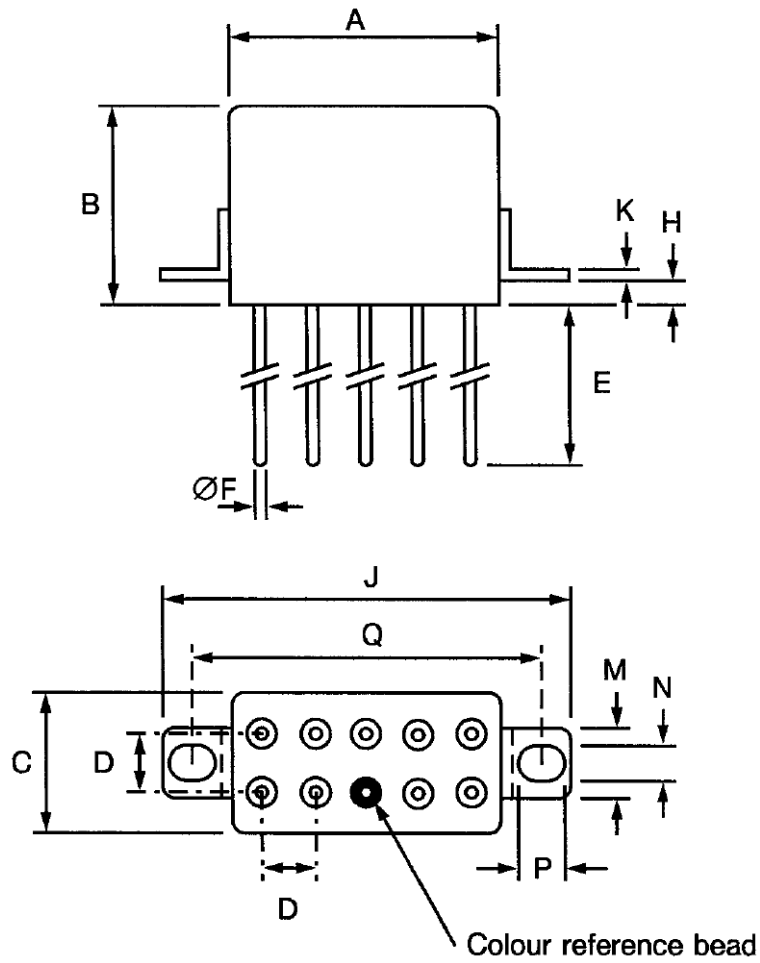

Symbols	Dimensions (mm)	
	Min	Max
A	-	13
B	-	10.4
C	-	6.1
D	2.41	2.67
E	37	39
ØF	0.45	0.55
H	3	3.4
J	-	22.85
K	0.3	0.5
M	4.5	4.9
N	2.15	2.65
P	3.1	3.3
Q	17.35	18.35

NOTES:

- Terminal identification is specified by reference to the colour reference bead. See Functional Diagram.

1.6.5 Raised Vertical Flange Mount and Solder Hook Terminals (Variant 06)

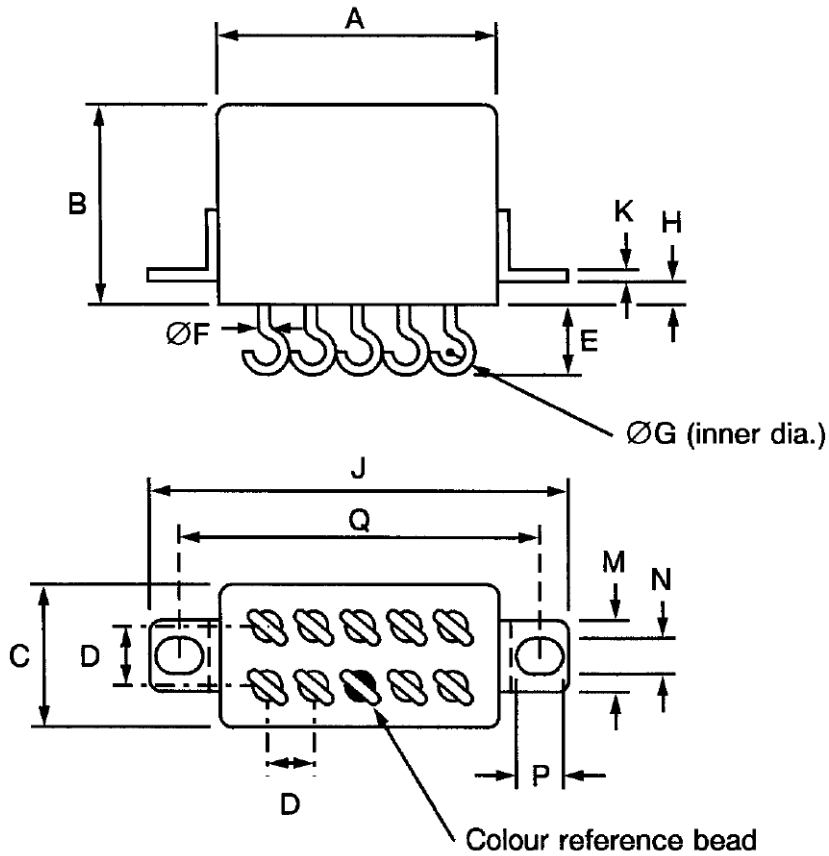

Symbols	Dimensions (mm)	
	Min	Max
A	-	13
B	-	10.4
C	-	6.1
D	2.41	2.67
E	2.9	3.9
ØF	0.45	0.55
ØG	-	0.9
H	3	3.4
J	-	22.85
K	0.3	0.5
M	4.5	4.9
N	2.15	2.65
P	3.1	3.3
Q	17.35	18.35

NOTES:

1. Terminal identification is specified by reference to the colour reference bead. See Functional Diagram.

1.6.6 Flush Vertical Flange Mount and Solder Pin Terminals (Variant 07)

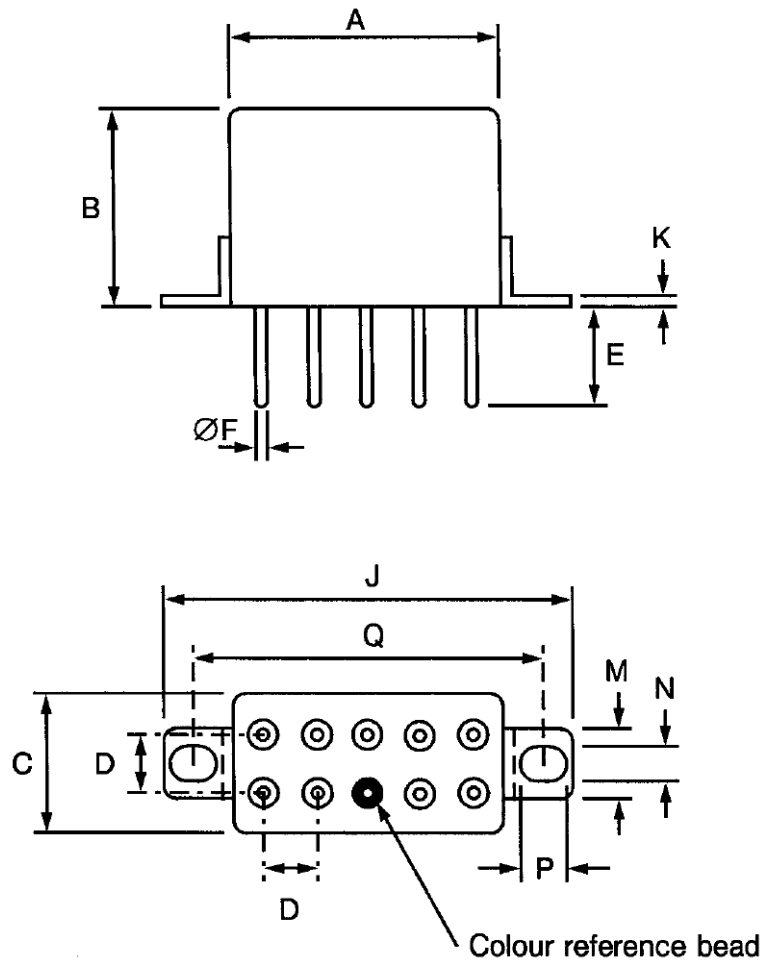

Symbols	Dimensions (mm)	
	Min	Max
A	-	13
B	-	10.4
C	-	6.1
D	2.41	2.67
E	4.4	5.2
ØF	0.45	0.55
J	-	22.85
K	0.3	0.5
M	4.5	4.9
N	2.15	2.65
P	3.1	3.3
Q	17.35	18.35

NOTES:

- Terminal identification is specified by reference to the colour reference bead. See Functional Diagram.

1.6.7 Horizontal Flange Mount and Long Lead Terminals (Variant 10)

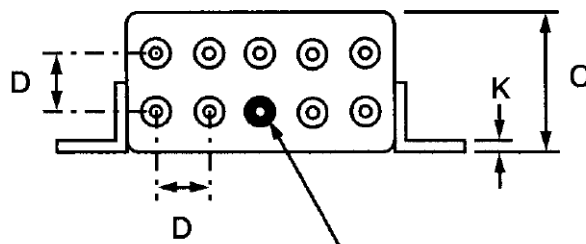
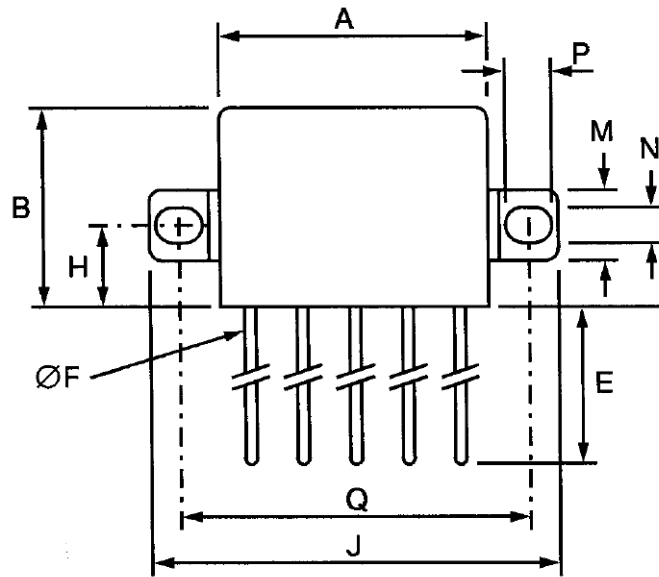

Colour reference bead

Symbols	Dimensions (mm)	
	Min	Max
A	-	13
B	-	10.4
C	-	6.1
D	2.41	2.67
E	37	39
ØF	0.45	0.55
H	5.2	5.6
J	-	22.85
K	0.3	0.5
M	4.5	4.9
N	2.15	2.65
P	3.1	3.3
Q	17.35	18.35

NOTES:

- Terminal identification is specified by reference to the colour reference bead. See Functional Diagram.

1.6.8 Horizontal Flange Mount and Solder Hook Terminals (Variant 11)

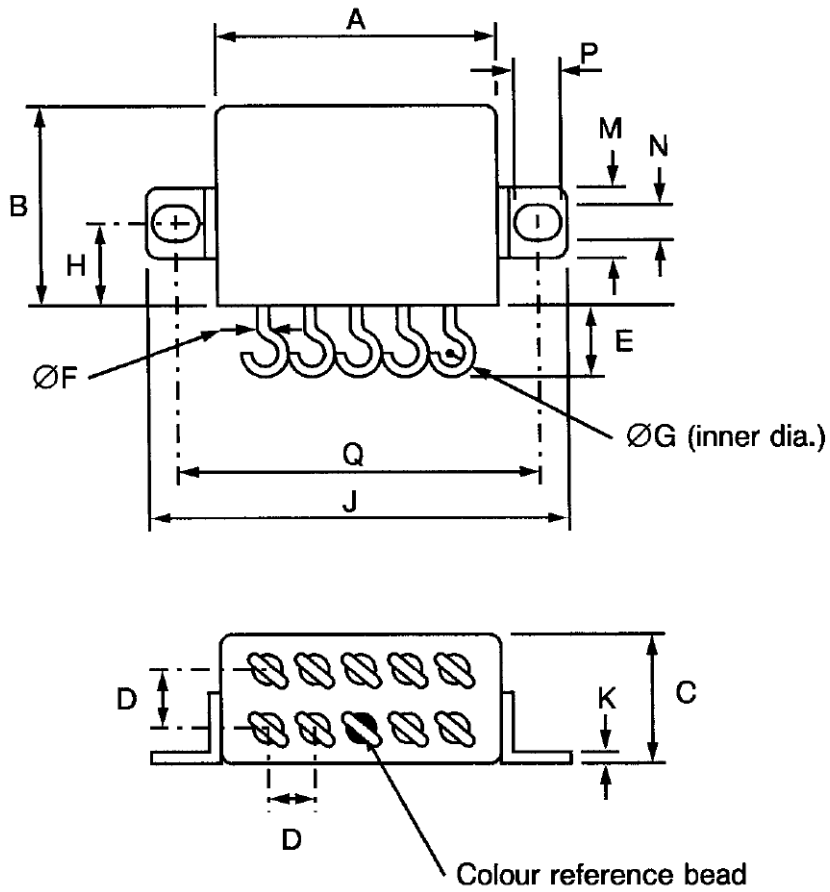

Symbols	Dimensions (mm)	
	Min	Max
A	-	13
B	-	10.4
C	-	6.1
D	2.41	2.67
E	2.9	3.9
$\text{Ø}F$	0.45	0.55
$\text{Ø}G$	-	0.9
H	5.2	5.6
J	-	22.85
K	0.3	0.5
M	4.5	4.9
N	2.15	2.65
P	3.1	3.3
Q	17.35	18.35

NOTES:

- Terminal identification is specified by reference to the colour reference bead. See Functional Diagram.

1.7 FUNCTIONAL DIAGRAM

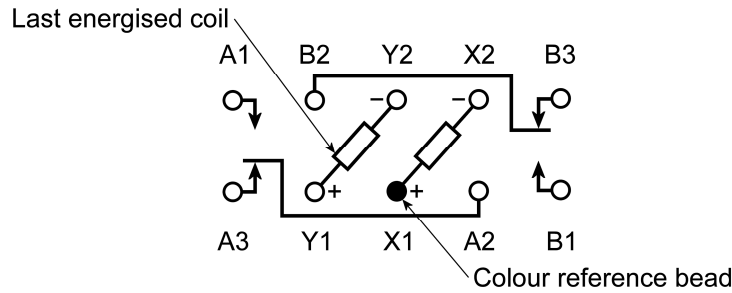

NOTES:

1. As viewed from the terminal side.
2. Individual terminal designations are for reference purposes only.

1.8 MATERIALS AND FINISHES

1.8.1 Case

Copper nickel, hermetically sealed. Tin-lead alloy plating may be used.

1.8.2 Terminals

The lead material and finish shall be by type D3 or D4 in accordance with the requirements of ESCC Basic Specification No. 23500.

2 REQUIREMENTS

2.1 GENERAL

The complete requirements for procurement of the components specified herein are as stated in this specification and the ESCC Generic Specification. Permitted deviations from the Generic Specification, applicable to this specification only, are listed below.

Permitted deviations from the Generic Specification and this Detail Specification, formally agreed with specific Manufacturers on the basis that the alternative requirements are equivalent to the ESCC requirement and do not affect the component's reliability, are listed in the appendices attached to this specification.

2.1.1 Deviations from the Generic Specification

None.

2.2 MARKING

The marking shall be in accordance with the requirements of ESCC Basic Specification No. 21700 and as follows.

The information to be marked on the component shall be:

- (a) The ESCC qualified components symbol (for ESCC qualified components only).
- (b) The ESCC Component Number.
- (c) Traceability information.

2.3 TERMINAL STRENGTH

The test conditions for Terminal Strength, tested as specified in the ESCC Generic Specification, shall be as follows:

- (a) Pull Test
 - Applied Force: 10N
- (b) Bend Test (Test Condition C)
 - Load: 5N

2.4 ELECTRICAL MEASUREMENTS AT ROOM, HIGH AND LOW TEMPERATURES

Electrical measurements shall be performed at room, high and low temperatures. Consolidated notes are given after the tables.

2.4.1 Room Temperature Electrical Measurements

The measurements shall be performed at $T_{amb} = +22 \pm 3^{\circ}\text{C}$.

Characteristics	Symbols	Test Method and Conditions	Rated Coil Voltage (Vdc)	Limits		Units
				Min	Max	
Latch Voltage	U_L	ESCC No. 3602 Note 1	26.5 12 6	7 3.5 1.5	14 7 3.5	V
Reset Voltage	U_R	ESCC No. 3602 Note 1	26.5 12 6	7 3.5 1.5	14 7 3.5	V
Latch Time	t_L	ESCC No. 3602	All	-	3	ms
Reset Time	t_R	ESCC No. 3602	All	-	3	ms
Bounce Time	t_B	ESCC No. 3602	All	-	1.5	ms
Insulation Resistance	R_I	ESCC No. 3602 $V_{TEST} = 100\text{Vdc}$	All	10	-	G Ω
Voltage Proof (Test Voltage)	VP	ESCC No. 3602 Maximum Leakage Current $I_{LVP} = 1\text{mA}$	All	500	-	Vrms
				350 (Note 2)	-	
Voltage Proof Leakage Current	I_{LVP}	ESCC No. 3602 Note 3	All	-	1	mA
Contact Voltage Drop	V_D	ESCC No. 3602 $I_{TEST} = 100\text{mA max}$	All	-	$0.1 \times I_{TEST}$	V
Coil Resistance	R_B	ESCC No. 3602 Both Coils	26.5	945	1155	Ω
			12	203	243	
			6	51	61	

2.4.2 High and Low Temperatures Electrical Measurements

Characteristics	Symbols	Test Method and Conditions	Rated Coil Voltage (Vdc)	Limits		Units
				Min	Max	
Latch Voltage	U_L	ESCC No. 3602 $T_{amb} = +125 (+0 -5)^{\circ}C$ and $-65 (+5 -0)^{\circ}C$ Note 1	26.5 12 6	- - -	18 9 4.5	V
Reset Voltage	U_R	ESCC No. 3602 $T_{amb} = +125 (+0 -5)^{\circ}C$ and $-65 (+5 -0)^{\circ}C$ Note 1	26.5 12 6	- - -	18 9 4.5	V
Latch Time	t_L	ESCC No. 3602 $T_{amb} = +125 (+0 -5)^{\circ}C$ and $-65 (+5 -0)^{\circ}C$	All	-	3	ms
Reset Time	t_R	ESCC No. 3602 $T_{amb} = +125 (+0 -5)^{\circ}C$ and $-65 (+5 -0)^{\circ}C$	All	-	3	ms
Bounce Time	t_B	ESCC No. 3602 $T_{amb} = +125 (+0 -5)^{\circ}C$ and $-65 (+5 -0)^{\circ}C$	All	-	1.5	ms
Insulation Resistance	R_I	ESCC No. 3602 $T_{amb} = +125 (+0 -5)^{\circ}C$ $V_{TEST} = 100Vdc$	All	100	-	MΩ
Contact Voltage Drop	V_D	ESCC No. 3602 $T_{amb} = +125 (+0 -5)^{\circ}C$ and $-65 (+5 -0)^{\circ}C$ $I_{TEST} = 100mA$ max	All	-	$0.1 \times I_{TEST}$	V

2.4.3 Notes to Electrical Measurements Tables

1. The coil voltage rise time shall be less than $0.1t_L$ or $0.1t_R$. The coil voltage shall be maintained for a minimum duration of $10t_L$ or $10t_R$.
2. Points of application (350V):
 - Between open contacts, coil de-energised.
 - Between open contacts, coil energised with Rated Coil Voltage.
3. Measured during Voltage Proof test.

2.5 PARAMETER DRIFT VALUES

Parameter Drift Values shall be measured as specified in the ESCC Generic Specification.

Unless otherwise specified, the measurements shall be performed at $T_{amb} = +22 \pm 3^{\circ}\text{C}$.

The test methods and test conditions shall be as per the corresponding test defined in Room Temperature Electrical Measurements.

The corresponding absolute limit values for each characteristic shall not be exceeded.

Characteristics	Symbols	Limits			Units
		Drift Value Δ	Absolute		
			Min	Max	
Latch Voltage	U_L	Note 1	Note 2	Note 2	V
Reset Voltage	U_R	Note 1	Note 2	Note 2	V

NOTES:

1. Drift Value (Δ) limits are not specified. Drift Values shall be recorded for information purposes only.
2. The limit specified in Room Temperature Electrical Measurements shall apply.

2.6 INTERMEDIATE AND END-POINT ELECTRICAL MEASUREMENTS

Unless otherwise specified, the measurements shall be performed at $T_{amb} = +22 \pm 3^{\circ}\text{C}$.

Unless otherwise specified the test methods and test conditions shall be as per the corresponding test defined in Room Temperature Electrical Measurements.

Test Reference per ESCC No. 3602	Characteristics (Note 1)	Symbols	Limits		Units
			Min	Max	
Thermal Shock	<u>During 5th Cycle</u>				
	Latch Voltage	U_L	Note 2	Note 2	V
	Reset Voltage	U_R	Note 2	Note 2	V
	Latch Time	t_L	Note 2	Note 2	ms
	Reset Time	t_R	Note 2	Note 2	ms
	<u>Final Measurements</u>				
	Voltage Proof	VP	Note 3	Note 3	Vrms
Voltage Proof Leakage Current	I_{LVP}	Note 3	Note 3	mA	

Test Reference per ESCC No. 3602	Characteristics (Note 1)	Symbols	Limits		Units
			Min	Max	
Low Level Sine Vibration	<u>Final Measurements</u>				
	Latch Voltage	U_L	Note 3		V
	Latch Voltage Drift	$\Delta U_L/U_L$	Note 1		%
	Reset Voltage	U_R	Note 3		V
	Reset Voltage Drift	$\Delta U_R/U_R$	Note 1		%
Random Vibration	<u>Final Measurements</u>				
	Latch Voltage	U_L	Note 3		V
	Latch Voltage Drift	$\Delta U_L/U_L$	Note 1		%
	Reset Voltage	U_R	Note 3		V
	Reset Voltage Drift	$\Delta U_R/U_R$	Note 1		%
High Level Sine Vibration	<u>Final Measurements</u>				
	Latch Voltage	U_L	Note 3		V
	Latch Voltage Drift	$\Delta U_L/U_L$	Note 1		%
	Reset Voltage	U_R	Note 3		V
	Reset Voltage Drift	$\Delta U_R/U_R$	Note 1		%
Low Level Mechanical Shock	<u>Final Measurements</u>				
	Contact Voltage Drop	V_D	Note 3		V
	Latch Voltage	U_L	Note 3		V
	Latch Voltage Drift	$\Delta U_L/U_L$	Note 1		%
	Reset Voltage	U_R	Note 3		V
	Reset Voltage Drift	$\Delta U_R/U_R$	Note 1		%
	Voltage Proof	VP	Note 3		Vrms
	Voltage Proof Leakage Current	I_{LVP}	Note 3		mA
High Level Mechanical Shock	<u>Final Measurements</u>				
	Contact Voltage Drop	V_D	Note 3		V
	Latch Voltage	U_L	Note 3		V
	Latch Voltage Drift	$\Delta U_L/U_L$	Note 1		%
	Reset Voltage	U_R	Note 3		V
	Reset Voltage Drift	$\Delta U_R/U_R$	Note 1		%
	Voltage Proof	VP	Note 3		Vrms
	Voltage Proof Leakage Current	I_{LVP}	Note 3		mA

Test Reference per ESCC No. 3602	Characteristics (Note 1)	Symbols	Limits		Units
			Min	Max	
Resistance to Soldering Heat	<u>Final Measurements</u>				
	Insulation Resistance	R_i		Note 3	GΩ
	Contact Voltage Drop	V_D		Note 3	V
	Latch Voltage	U_L		Note 3	V
	Reset Voltage	U_R		Note 3	V
	Coil Resistance	R_B		Note 3	Ω
Low Level Life	<u>Final Measurements</u>				
	Contact Voltage Drop	V_D	-	$0.2 \times I_{TEST}$	V
	Insulation Resistance	R_i	5000	-	MΩ
	Voltage Proof	VP		Note 3	Vrms
	Voltage Proof Leakage Current	I_{LVP}		Note 3	mA
	Latch Voltage	U_L		Note 3	V
	Latch Voltage Drift	$\Delta U_L / U_L$		Note 1	%
	Reset Voltage	U_R		Note 3	V
	Reset Voltage Drift	$\Delta U_R / U_R$		Note 1	%
	Latch Time	t_L		Note 3	ms
	Reset Time	t_R		Note 3	ms
	Bounce Time	t_B		Note 3	ms
	Coil Resistance	R_B		Note 3	Ω
Resistive Life	<u>During Monitoring</u>				
	Contact Voltage Drop	V_D	-	2.8	V
	<u>Final Measurements</u>				
	Contact Voltage Drop	V_D	-	$0.2 \times I_{TEST}$	V
	Insulation Resistance	R_i	5000	-	MΩ
	Voltage Proof	VP		Note 3	Vrms
	Voltage Proof Leakage Current	I_{LVP}		Note 3	mA
	Latch Voltage	U_L		Note 3	V
	Latch Voltage Drift	$\Delta U_L / U_L$		Note 1	%
	Reset Voltage	U_R		Note 3	V
	Reset Voltage Drift	$\Delta U_R / U_R$		Note 1	%
	Latch Time	t_L		Note 3	ms
	Reset Time	t_R		Note 3	ms
	Bounce Time	t_B		Note 3	ms
Coil Resistance	R_B		Note 3	Ω	

Test Reference per ESCC No. 3602	Characteristics (Note 1)	Symbols	Limits		Units
			Min	Max	
Coil Life	<u>During Step 1 of each Cycle</u>				
	Contact Voltage Drop	V_D	Note 3		V
	Coil Resistance	R_B	Note 3		Ω
	<u>During Step 3 of 1st Cycle</u>				
	Contact Voltage Drop	V_D	Note 2		V
	Latch Time	t_L	Note 2		ms
	Reset Time	t_R	Note 2		ms
	<u>During Steps 4 & 5 of 4th Cycle</u>				
	Latch Voltage	U_L	Note 2		V
	Reset Voltage	U_R	Note 2		V
	<u>Final Measurements</u>				
	Voltage Proof	VP	Note 3		Vrms
	Voltage Proof Leakage Current	I_{LVP}	Note 3		mA
	Insulation Resistance	R_I	Note 3		G Ω
	Contact Voltage Drop	V_D	Note 3		V
	Coil Resistance	R_B	Note 3		Ω
	Latch Time	t_L	Note 3		ms
	Reset Time	t_R	Note 3		ms
Bounce Time	t_B	Note 3		ms	

Test Reference per ESCC No. 3602	Characteristics (Note 1)	Symbols	Limits		Units
			Min	Max	
Intermediate Current	<u>During Monitoring</u>				
	Contact Voltage Drop	V_D	-	300	mV
	<u>Final Measurements</u>				
	Insulation Resistance	R_I	5000	-	MΩ
	Voltage Proof	VP	Note 3		Vrms
	Voltage Proof Leakage Current	I_{LVP}	Note 3		mA
	Latch Voltage	U_L	Note 3		V
	Latch Voltage Drift	$\Delta U_L/U_L$	Note 1		%
	Reset Voltage	U_R	Note 3		V
	Reset Voltage Drift	$\Delta U_R/U_R$	Note 1		%
	Latch Time	t_L	Note 3		ms
	Reset Time	t_R	Note 3		ms
	Bounce Time	t_B	Note 3		ms
	Coil Resistance	R_B	Note 3		Ω
	Contact Voltage Drop	V_D	-	$0.2 \times I_{TEST}$	V
Overload	<u>During Monitoring</u>				
	Contact Voltage Drop	V_D	-	1.4	V
	<u>Final Measurements</u>				
	Contact Voltage Drop	V_D	-	$0.2 \times I_{TEST}$	V
	Insulation Resistance	R_I	5000	-	MΩ
	Voltage Proof	VP	Note 3		Vrms
	Voltage Proof Leakage Current	I_{LVP}	Note 3		mA
	Latch Voltage	U_L	Note 3		V
	Latch Voltage Drift	$\Delta U_L/U_L$	Note 1		%
	Reset Voltage	U_R	Note 3		V
	Reset Voltage Drift	$\Delta U_R/U_R$	Note 1		%
	Latch Time	t_L	Note 3		ms
	Reset Time	t_R	Note 3		ms
	Bounce Time	t_B	Note 3		ms
	Coil Resistance	R_B	Note 3		Ω

NOTES:

1. Parameter Drift shall be calculated referenced to the measurement immediately prior to the test in question. An additional initial measurement may be performed prior to the test in question if considered necessary. Drift limits are not specified. Drift Values shall be recorded for information purposes only.
2. The limits specified in High and Low Temperatures Electrical Measurements, as applicable to the same test temperature, shall apply.
3. The limits specified in Room Temperature Electrical Measurements shall apply.

2.7

RUN-IN CONDITIONS

The test conditions for Run-in, tested as specified in the ESCC Generic Specification, shall be as follows:

- (a) Test Temperature: $+22 \pm 3^{\circ}\text{C}$.

APPENDIX A**AGREED DEVIATIONS FOR LEACH INTERNATIONAL EUROPE (F)**

ITEMS AFFECTED	DESCRIPTION OF DEVIATIONS
Materials and Finishes: Terminals	For components specified with terminal finish type 3, the tin-lead plating shall have a composition of 85 to 95% tin (remainder lead).
Deviations from the Generic Specification: Qualification and Periodic Tests (Chart F4)	High Level Sine Vibration: Not Applicable
	High Level Mechanical Shock: Not Applicable
	Chart F4: Coil Life subgroup test sequence (under Endurance Subgroup 1): Coil Life and the subsequent tests shall only be performed for Qualification. They are not required for Periodic Testing except in the case of any significant change to the design.