



Page 1 of 27

**CONNECTORS, ELECTRICAL, RECTANGULAR,
MICROMINIATURE, NON-REMOVABLE GAUGE 26
PCB PIN CONTACTS**

BASED ON TYPE 8MCG

ESCC Detail Specification No. 3401/081

Issue 6	June 2018
---------	-----------



Document Custodian: European Space Agency – see <https://escies.org>

LEGAL DISCLAIMER AND COPYRIGHT

European Space Agency, Copyright © 2018. All rights reserved.

The European Space Agency disclaims any liability or responsibility, to any person or entity, with respect to any loss or damage caused, or alleged to be caused, directly or indirectly by the use and application of this ESCC publication.

This publication, without the prior permission of the European Space Agency and provided that it is not used for a commercial purpose, may be:

- copied in whole, in any medium, without alteration or modification.
- copied in part, in any medium, provided that the ESCC document identification, comprising the ESCC symbol, document number and document issue, is removed.

DOCUMENTATION CHANGE NOTICE

(Refer to <https://escies.org> for ESCC DCR content)

DCR No.	CHANGE DESCRIPTION
1163	Specification upissued to incorporate editorial changes per DCR.

TABLE OF CONTENTS

1	GENERAL	6
1.1	SCOPE	6
1.2	COMPONENT TYPE VARIANTS AND RANGE OF COMPONENTS	6
1.3	MAXIMUM RATINGS	6
1.4	PARAMETER DERATING INFORMATION	6
1.5	PHYSICAL DIMENSIONS	6
2	APPLICABLE DOCUMENTS	6
3	TERMS, DEFINITIONS, ABBREVIATIONS, SYMBOLS AND UNITS	6
4	REQUIREMENTS	18
4.1	GENERAL	18
4.2	DEVIATIONS FROM GENERIC SPECIFICATION	18
4.2.1	Deviations from Special In-Process Controls	18
4.2.2	Deviations from Final Production Tests (Chart II)	19
4.2.3	Deviations from Burn-in and Electrical Measurements (Chart III)	19
4.2.4	Deviations from Qualification Tests (Chart IV)	19
4.2.5	Deviations from Lot Acceptance Tests (Chart V)	19
4.3	MECHANICAL REQUIREMENTS	19
4.3.1	Dimension Check	19
4.3.2	Weight	19
4.3.3	Contact Capability	19
4.3.4	Contact Retention (in Insert)	19
4.3.5	Mating and Unmating Forces	19
4.3.6	Insert Retention (in Shell)	19
4.3.7	Jackscrew Retention	20
4.3.8	Contact Insertion and Withdrawal Forces	20
4.3.9	Engagement and Separation Forces	20
4.3.10	Oversize Pin Exclusion	20
4.3.11	Probe Damage	20
4.3.12	Solderability	20
4.4	MATERIALS AND FINISHES	20
4.4.1	Shells	20
4.4.2	Inserts	20
4.4.3	Contacts	20
4.4.4	Brackets	20
4.4.5	Accessories	20

4.4.6	Magnetism Level	20
4.5	MARKING	21
4.5.1	General	21
4.5.2	Contact Position	21
4.5.3	The ESCC Component Number	21
4.5.4	Characteristics	21
4.5.4.1	Shell Size and Contact Arrangement	21
4.5.4.2	Type of Contact	21
4.5.4.3	Magnetism Level	22
4.5.4.4	Contact Termination Code	22
4.5.5	Traceability Information	22
4.6	ELECTRICAL MEASUREMENTS	22
4.6.1	Electrical Measurements at Room Temperature	22
4.6.2	Electrical Measurements at High and Low Temperatures (Table 3)	22
4.6.3	Circuits for Electrical Measurements (Figure 4)	22
4.7	BURN-IN AND ELECTRICAL MEASUREMENTS (TABLES 4 AND 5)	22
4.8	ENVIRONMENTAL AND ENDURANCE TESTS (CHARTS IV AND V OF ESCC GENERIC SPECIFICATION NO. 3401)	23
4.8.1	Measurements and Inspections on Completion of Environmental Tests	23
4.8.2	Measurements and Inspections at Intermediate Points During Endurance Tests	23
4.8.3	Measurements and Inspections on Completion of Endurance Tests	23
4.8.4	Conditions for Operating Life Test (Part of Endurance Testing) (Table 5)	23
4.8.5	Electrical Circuit for Operating Life Test (Figure 5)	23
4.8.6	Conditions for High Temperature Storage Test (Part of Endurance Testing)	23
APPENDIX 'A'		27

1 **GENERAL**

1.1 **SCOPE**

This specification details the ratings, physical and electrical characteristics, test and inspection data for Connectors, Electrical, Rectangular, Microminiature, Non-removable Gauge 26 PCB Pin Contacts, based on Type 8MCG.

The following ESCC Specifications, the requirements of which are supplemented herein, are associated with this specification:

- ESCC Generic Specification No. [3401](#), Connectors, Electrical, Non-Filtered, Circular and Rectangular.
- ESCC Detail Specification No. [3401/082](#), Connectors, Electrical, Rectangular, Microminiature, Removable Gauge 26 Crimp Contacts, Based on Type 8MCG.
- ESCC Detail Specification No. [3401/084](#), Accessories for Rectangular Connectors, Microminiature, 3401/081, 3401/082 and Connector Savers 3401/088.
- ESCC Detail Specification No. [3401/088](#), Connector Savers, Electrical, Rectangular, Microminiature, Non-removable Gauge 26 Contacts, Based on Type 8MCG.

1.2 **COMPONENT TYPE VARIANTS AND RANGE OF COMPONENTS**

The different sizes of the connectors and contact types specified herein, which are also covered by this specification, together with their mechanical characteristics, are scheduled in Table 1(a).

1.3 **MAXIMUM RATINGS**

The maximum ratings, which shall not be exceeded at any time during use or storage, applicable to the connectors specified herein, are scheduled in Table 1(b).

1.4 **PARAMETER DERATING INFORMATION**

The derating information applicable to the connectors specified herein is shown in Figure 1.

1.5 **PHYSICAL DIMENSIONS**

The physical dimensions of the connectors specified herein, and the available contact arrangements, are shown in Figure 2.

2 **APPLICABLE DOCUMENTS**

The following documents form part of this specification and shall be read in conjunction with it:

- (a) ESCC Generic Specification No. [3401](#), Connectors, Electrical, Non-Filtered, Circular and Rectangular.
- (b) ESCC Detail Specification No. [3401/084](#), Accessories for Rectangular Connectors, Microminiature, 3401/081, 3401/082 and Connector Savers 3401/088.
- (c) ESCC Detail Specification No. [3401/088](#), Connector Savers, Electrical, Rectangular, Microminiature, Non-removable Gauge 26 Contacts, Based on Type 8MCG.

3 **TERMS, DEFINITIONS, ABBREVIATIONS, SYMBOLS AND UNITS**

For the purpose of this specification, the terms, definitions, abbreviations, symbols and units specified in ESCC Basic Specification No. [21300](#) shall apply.

TABLE 1(a) - COMPONENT TYPE VARIANTS AND RANGE OF COMPONENTS

SHELL SIZES

Shell Size (Note 1)	Weight Max (g) (Notes 2, 3)		Mating Force (N) Max	Unmating Force (N)	
	Variant 01 (Note 4)	Variant 02 (Note 4)		Min	Max
A	1.05	1.35	11.9	0.95	11.9
B	1.35	1.75	18.7	1.5	18.7
C	1.6	2.15	22.1	1.8	22.1
D	1.8	2.35	28.9	2.35	28.9
E	2.1	2.7	35.7	2.9	35.7
F	2.35	2.95	42.5	3.5	42.5
G	2.5	3.15	56.1	4.6	56.1
H	3.44	4.2	86.7	7.1	86.7
J	6.1	7.3	178.8	14.5	178.8

CONTACT TYPES

Contact Termination Code (Note 5)	Contact Type Description	Weight of Contact (g) (Note 3)
OL3	Gauge 26 straight PCB solder contact	0.08
1AON	Gauge 26 90° PCB solder contact (2.54mm row spacing)	0.09 (Note 6) 0.097 (Note 7) 0.11 (Note 8)
1BON	Gauge 26 90° PCB solder contact (2.84mm row spacing)	0.093 (Note 6) 0.1 (Note 7) 0.12 (Note 8)
1A7N or 1B7N	Gauge 26 90° PCB solder contact (1A7N has 2.54mm row spacing; 1B7N has 2.84mm row spacing) Connector equipped with 90° bracket and jackpost kits (Note 9) Jackpost kit has either 2-56 nut or 4-40 nut (Note 10)	For 1A7N see 1AON above; For 1B7N see 1BON above

NOTES:

1. See Figure 2(a).
2. Weights without contacts or accessories.
3. The total weight of the connector shall be calculated from the number of contacts (see Figure 2(b)) multiplied by the applicable Weight of Contact plus the connector weight and, where applicable, the weight of a 90° bracket and jackpost kit (see Note 9 below).
4. Refer to Para. 4.4.1 for definition of the Type Variants.
5. See Figure 2(c).
6. Average weight for Shell Sizes A, B, C, D, E, F.
7. Average weight for Shell Sizes G, H.
8. Average weight for Shell Size J.

- 9. Weight of a bracket and jackpost kit is 3.5g.
- 10. Jackpost kit with 4-40 nut applies to shell size J only.

TABLE 1(b) - MAXIMUM RATINGS

No.	Characteristics	Symbol	Maximum Ratings	Unit	Remarks
1	Working Voltage Sea Level	U_R	150	Vrms	Note 1
2	Rated Current	I_R	2.5	A	
3	Operating Temperature Range	T_{op}	-55 to +125	°C	T_{amb}
4	Storage Temperature Range	T_{stg}	-65 to +125	°C	
5	Soldering Temperature	T_{sol}	+260	°C	Note 2

NOTES:

- 1. Between contact and shell.
- 2. Duration 10 seconds maximum and the same contact shall not be resoldered until 3 minutes have elapsed.

FIGURE 1 - PARAMETER DERATING INFORMATION

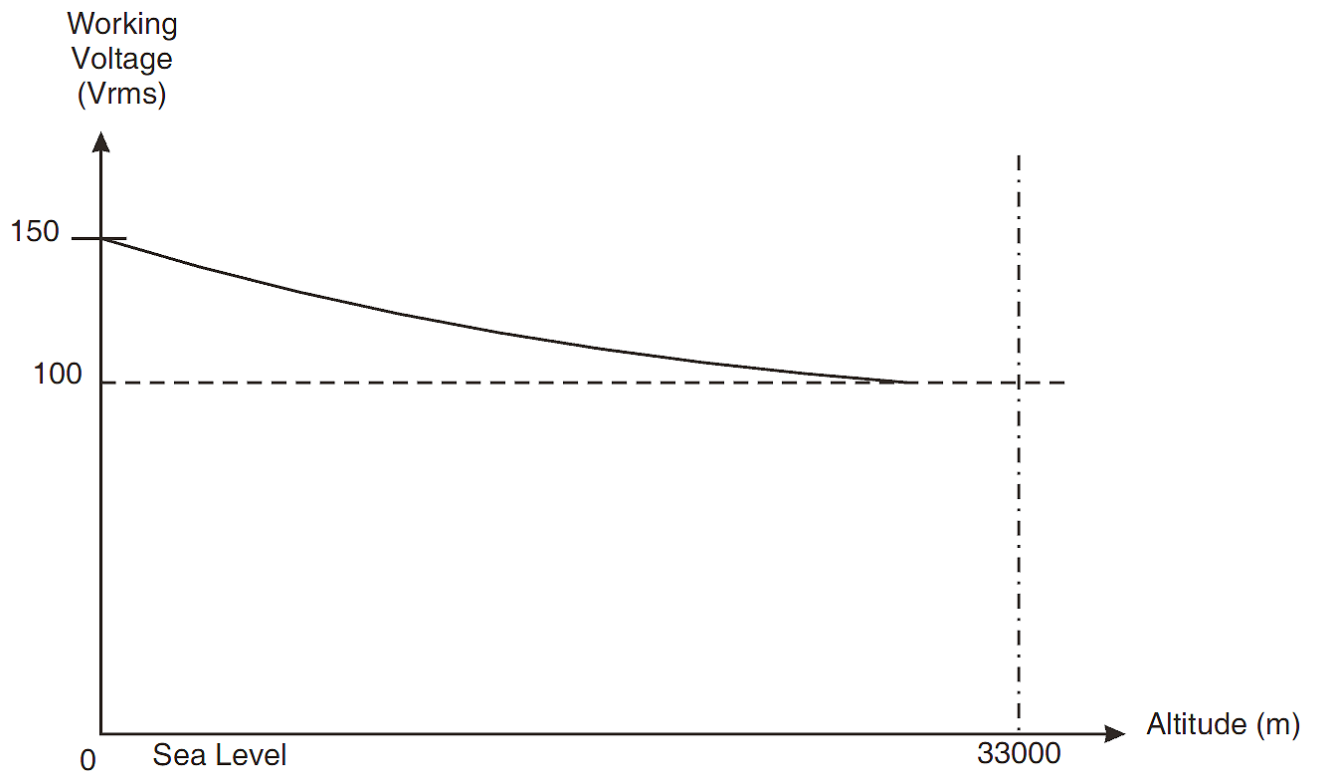
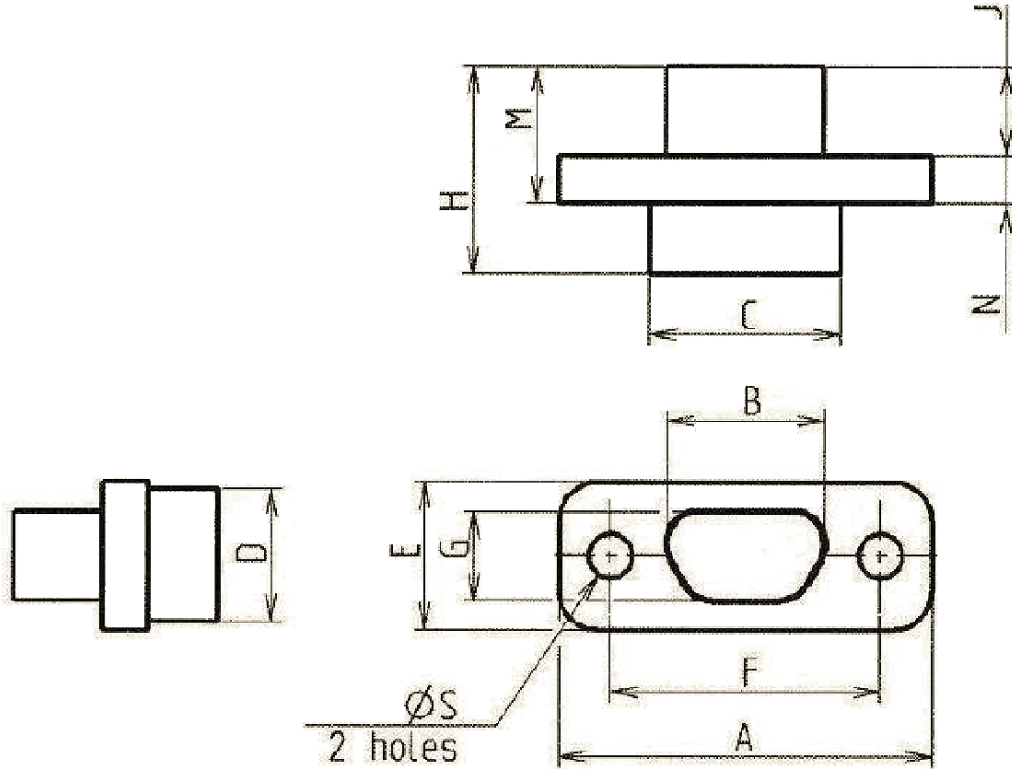

FIGURE 2 - PHYSICAL DIMENSIONS

FIGURE 2(a) - CONNECTOR SHELL



Shell Size	A Max	B Max	C Max	D Max	E Max	E		G Max	H Max	J Max	M Max	N		ØS (Note 2)	
						Min	Max					Min	Max	Min	Max
A	19.94	8.48	10.16	6.86	7.82	14.22	14.48	4.69	10.82	4.72	7.21	2.23	2.49	2.26	2.39
B	23.75	12.29	13.97	6.86	7.82	18.03	18.29	4.69	10.82	4.72	7.21	2.23	2.49	2.26	2.39
C	27.56	16.1	17.78	6.86	7.82	21.84	22.1	4.69	10.82	4.72	7.21	2.23	2.49	2.26	2.39
D	30.1	18.64	20.32	6.86	7.82	24.38	24.64	4.69	10.82	4.72	7.21	2.23	2.49	2.26	2.39
E	33.91	22.45	24.13	6.86	7.82	28.19	28.45	4.69	10.82	4.72	7.21	2.23	2.49	2.26	2.39
F	37.72	26.26	27.94	6.86	7.82	32	32.26	4.69	10.82	4.72	7.21	2.23	2.49	2.26	2.39
G	36.45	24.99	26.67	7.87	8.92	30.73	30.99	5.78	10.82	4.72	7.21	2.23	2.49	2.26	2.39
H	48.55	36.85	38.65	7.87	8.92	43.23	43.49	5.78	10.82	4.72	7.21	2.23	2.49	2.26	2.39
J	62.75	46.8	47.65	11.25	12.5	54.72	54.98	9.25	10.82	4.72	7.21	2.23	2.49	3.7	3.83

NOTES:

1. All dimensions are in millimetres.
2. For shell size H only, the mounting holes may be as shown below. Such holes shall be centred as per the circular holes shown above.

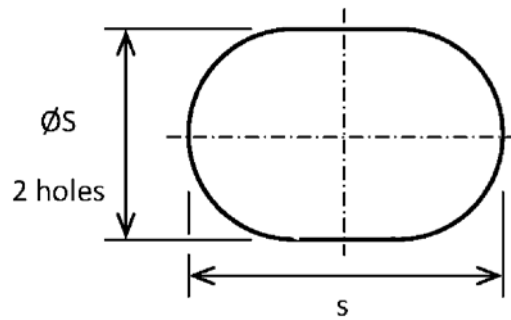

2 holes

Dimension s shall be 2.76mm minimum and 2.99mm maximum.

- Only the underlined dimensions shall be checked during procurement.

FIGURE 2(b) - CONTACT ARRANGEMENTS

FRONT VIEW MALE INSERT

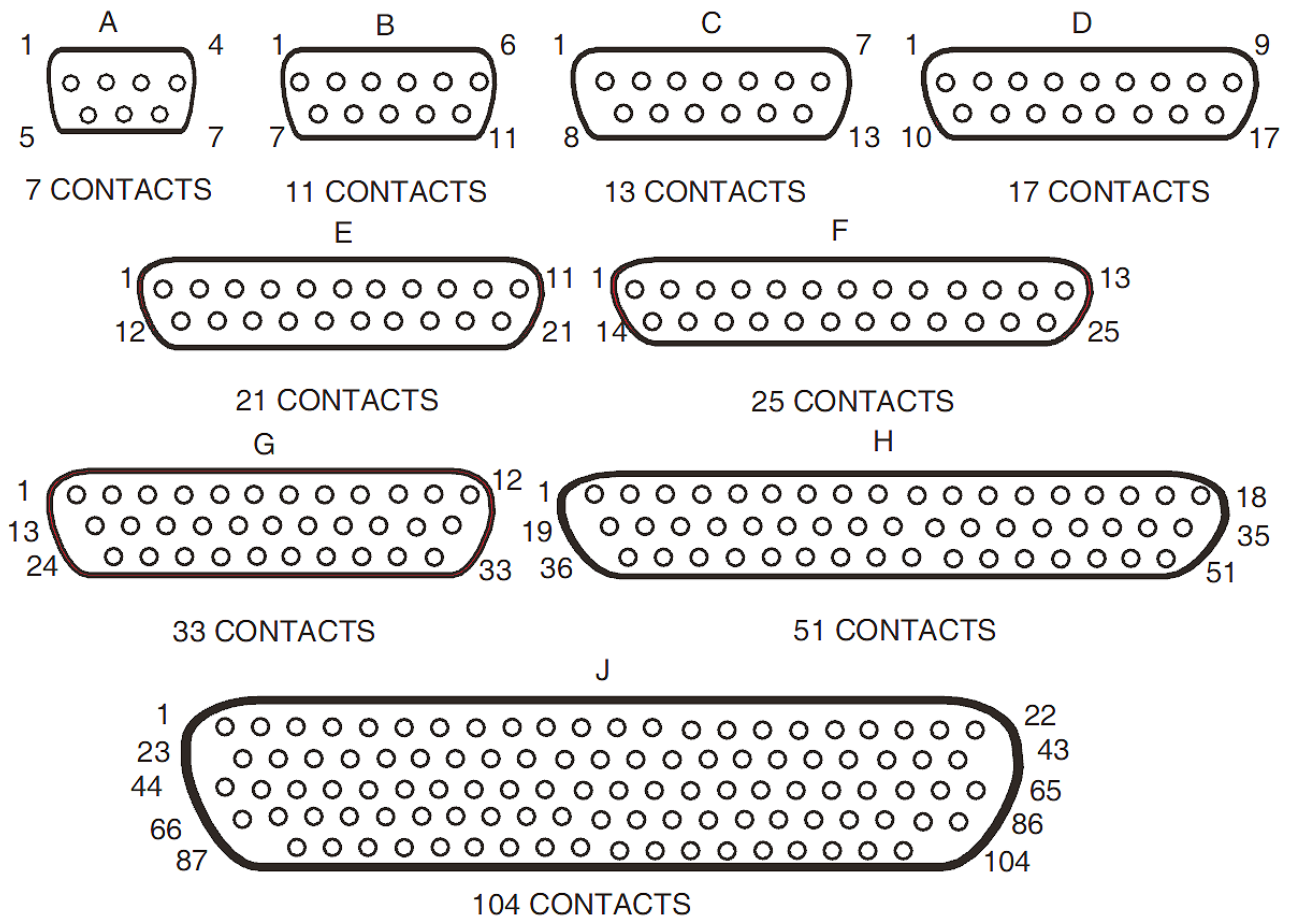

NOTES:

- Only the outside contact cavities on each row are identified in the drawing, the remainder follow sequentially. Contact numbers are shown outside the insert for readability.

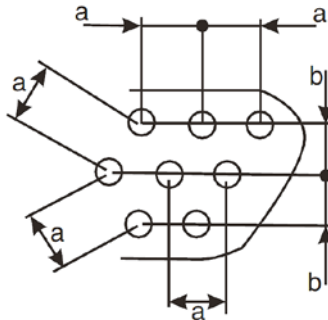

2. a = Distance between contact centres: 2mm typical.
- b = Distance between rows: 1.732mm typical.

FIGURE 2(c) - REAR END

GAUGE 26 STRAIGHT PCB SOLDER CONTACTS (CODE OL3)

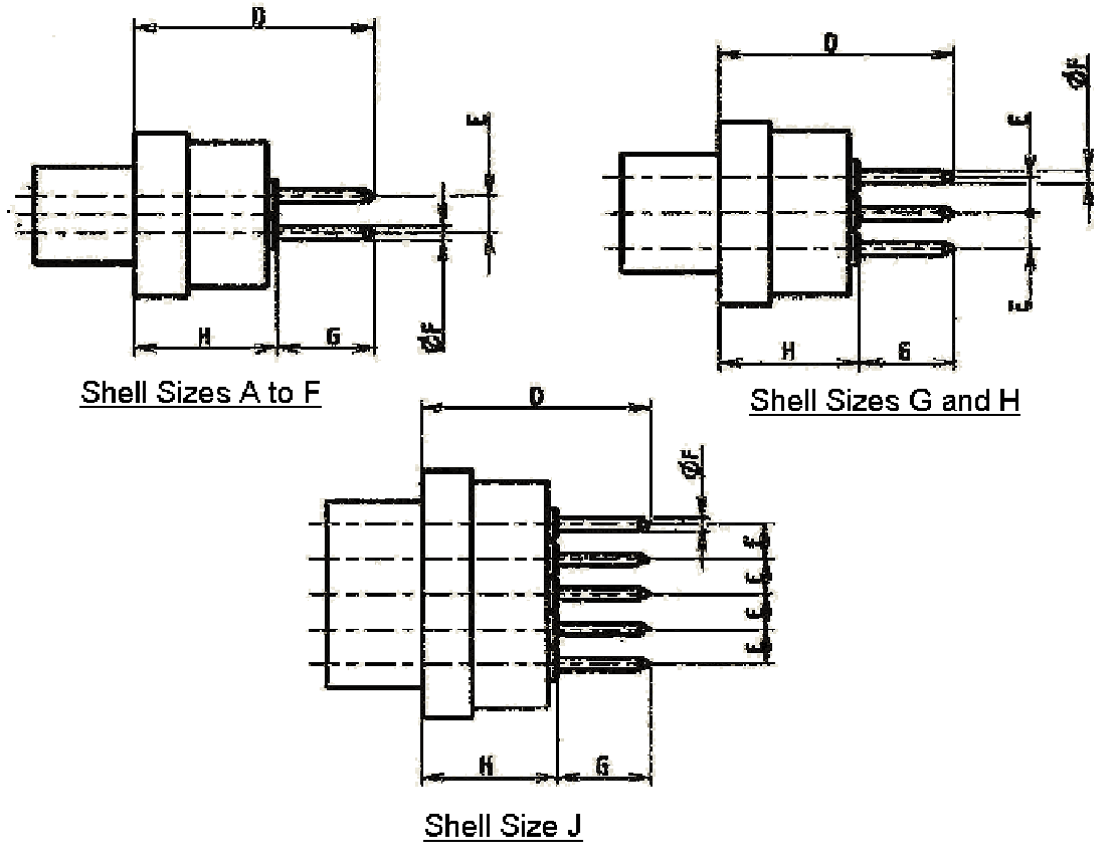

Pitch between contacts (all Shell Sizes): 2

Symbol Dim.	<u>D</u>	E	<u>ØF</u>	<u>G</u> (Note 2)	H
Min	-	1.662	0.48	4.4	-
Max	11.7	1.802	0.55	4.6	7

NOTES:

1. All dimensions are in millimetres.
2. This dimension is the length of the PCB tail extension of the contact.
3. Only the underlined dimensions shall be checked during procurement.

GAUGE 26 90° PCB SOLDER CONTACTS (SHELL SIZES A TO F) (CODES 1AON, 1BON)

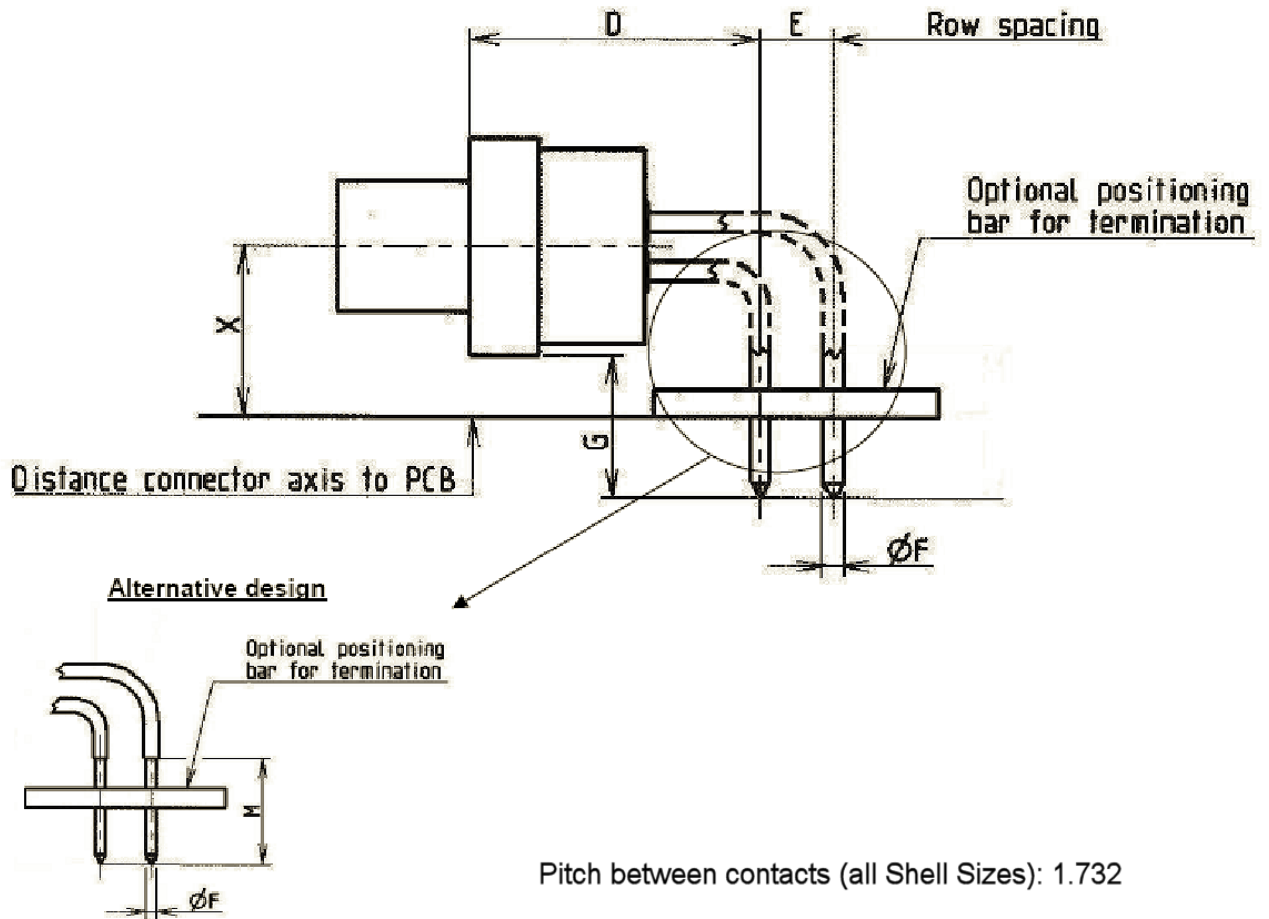

Symbol Dim.	D	E		<u>ØF</u>	G	<u>M</u>	X
		1AON	1BON				
Min	9.95	2.49	2.79	0.48	4.7	5.3	4.9
Max	10.45	2.59	2.89	0.55	5.3	-	5.1

NOTES:

1. All dimensions are in millimetres.
2. Only the underlined dimensions shall be checked during procurement.

GAUGE 26 90° PCB SOLDER CONTACTS (SHELL SIZES G AND H) (CODES 1AON, 1BON)

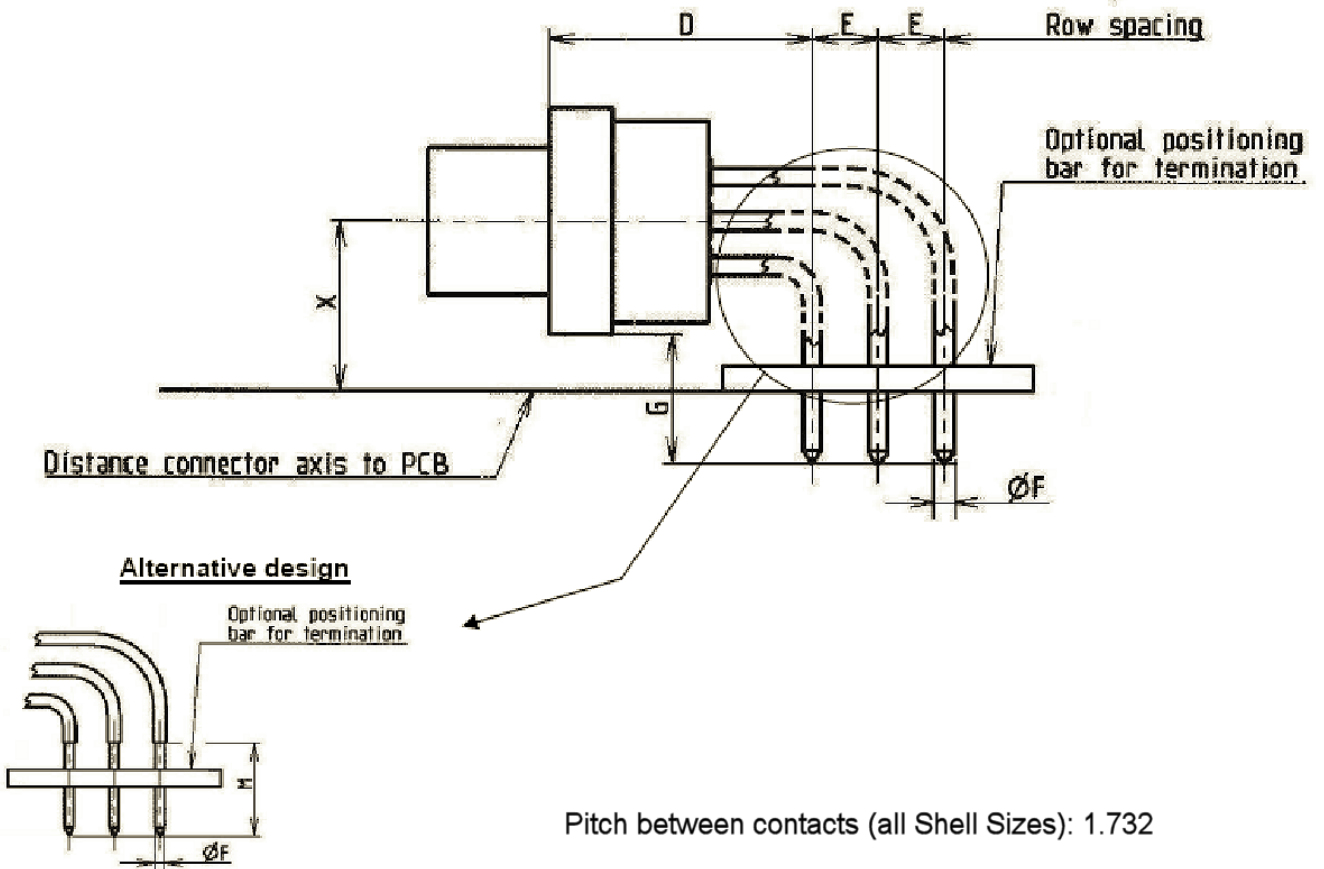

Symbol Dim.	D	E		ØE	G	M	X
		1AON	1BON				
Min	9.95	2.49	2.79	0.48	4.7	5.3	5.5
Max	10.45	2.59	2.89	0.55	5.3	-	5.7

NOTES:

1. All dimensions are in millimetres.
2. Only the underlined dimensions shall be checked during procurement.

GAUGE 26 90° PCB SOLDER CONTACTS (SHELL SIZE J) (CODES 1AON, 1BON)

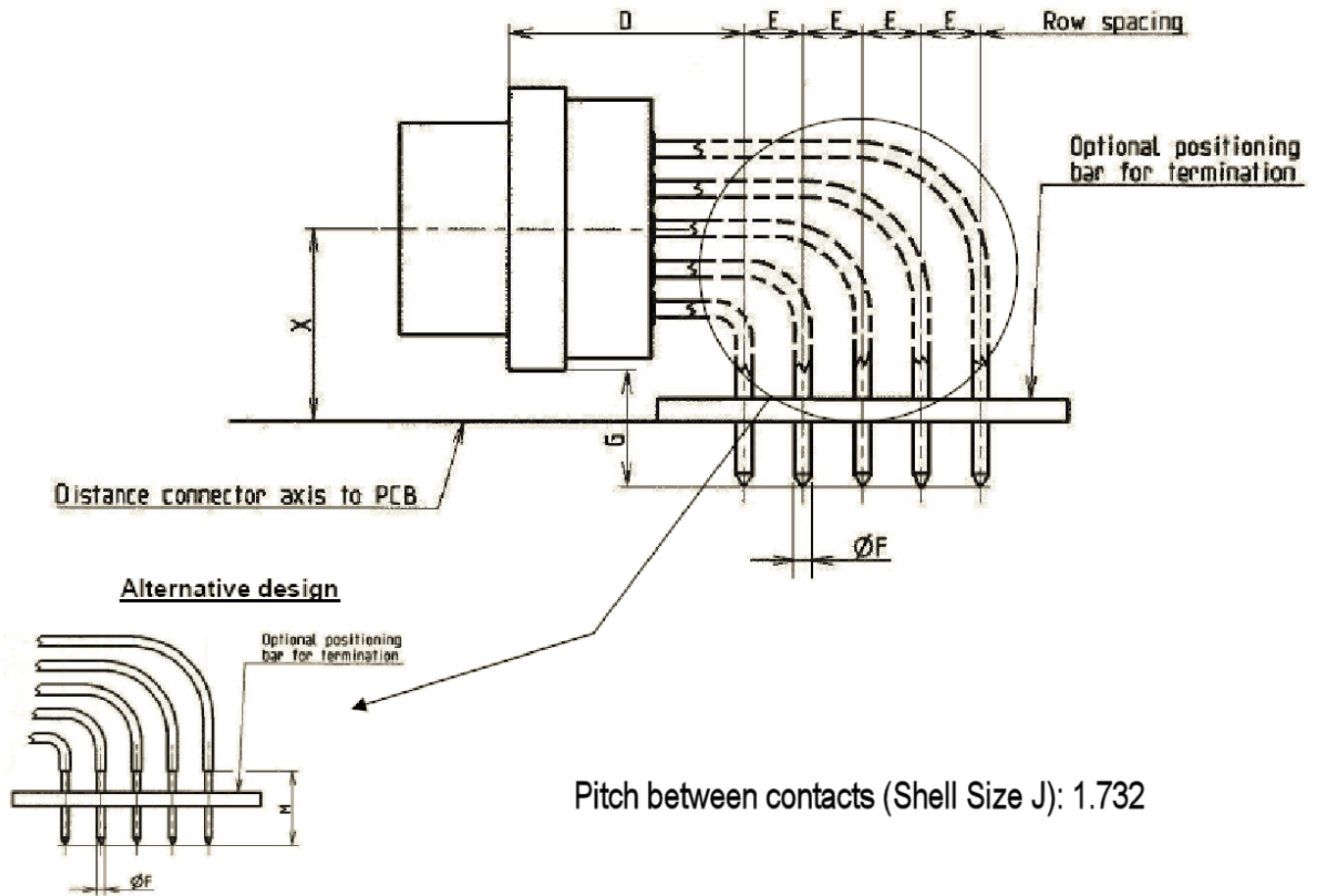

Pitch between contacts (Shell Size J): 1.732

Symbol Dim.	D	E		<u>ØE</u>	G	<u>M</u>	X
		1AON	1BON				
Min	9.95	2.49	2.79	0.48	4.7	5.3	7.25
Max	10.45	2.59	2.89	0.55	5.3	-	7.45

NOTES:

1. All dimensions are in millimetres.
2. Only the underlined dimensions shall be checked during procurement.

GAUGE 26 90° PCB SOLDER CONTACTS WITH BRACKETS AND JACKPOST KITS (SHELL SIZES A TO F) (CODES 1A7N, 1B7N)

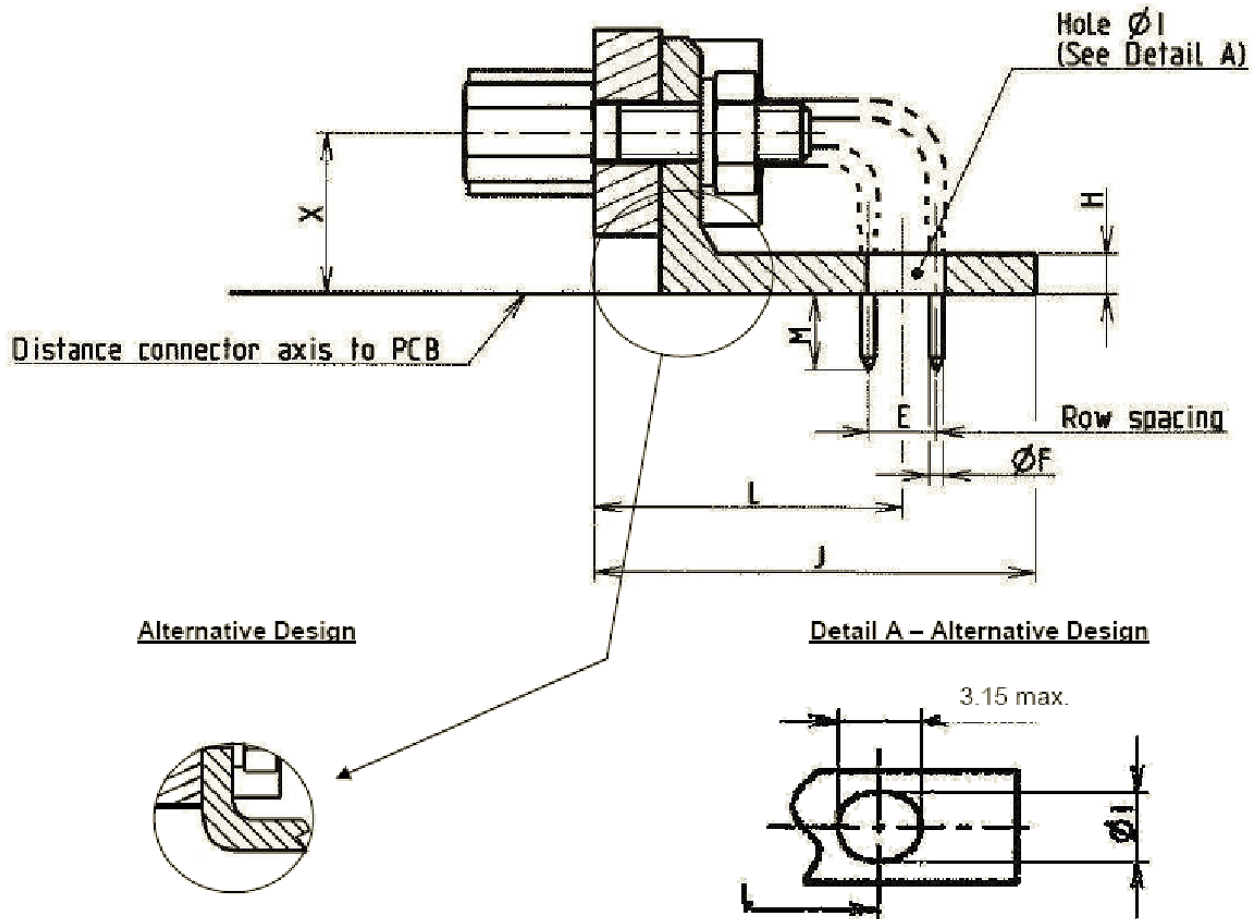

Symbol Dim.	E		<u>ØE</u>	H	ØI	J	<u>L</u>	<u>M</u>	<u>X</u>
	1A7N	1B7N							
Min	2.49	2.79	0.48	1.4	2.34	-	11.28	3.42	4.9
Max	2.59	2.89	0.55	2.1	2.54	16.6	11.78	4.22	5.1

NOTES:

1. All dimensions are in millimetres.
2. See Table 1(a) for size of nut.
3. Only the underlined dimensions shall be checked during procurement.

GAUGE 26 90° PCB SOLDER CONTACTS WITH BRACKETS AND JACKPOST KITS (SHELL SIZES G AND H) (CODES 1A7N, 1B7N)

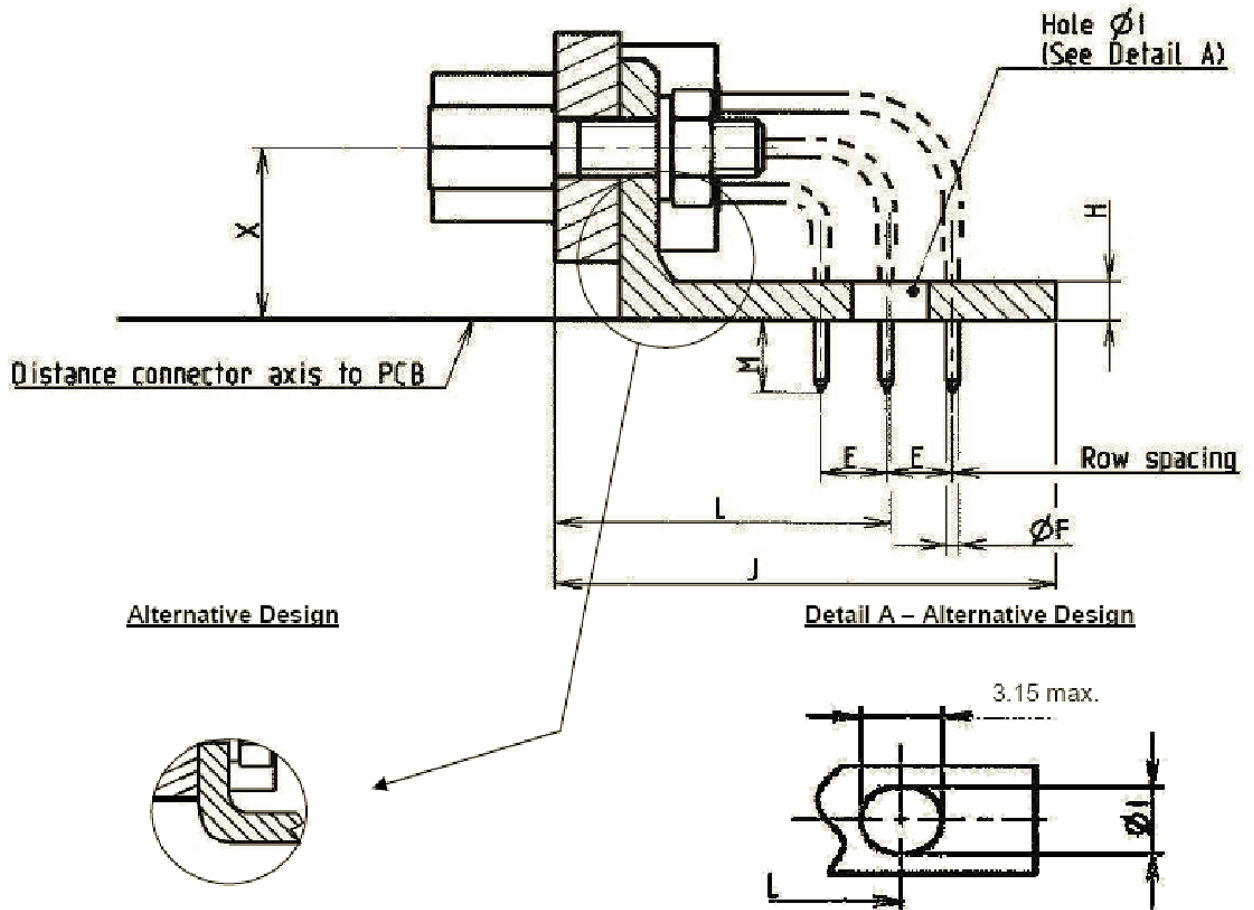

Symbol Dim.	E		<u>ØE</u>	H	ØI	J	L	M	X
	1A7N	1B7N							
Min	2.49	2.79	0.48	1.4	2.34	-	12.55	3.42	5.5
Max	2.59	2.89	0.55	2.1	2.54	19.4	13.05	4.22	5.7

NOTES:

1. All dimensions are in millimetres.
2. See Table 1(a) for size of nut.
3. Only the underlined dimensions shall be checked during procurement.

GAUGE 26 90° PCB SOLDER CONTACTS WITH BRACKETS AND JACKPOST KITS (SHELL SIZE J) (CODES 1A7N, 1B7N)

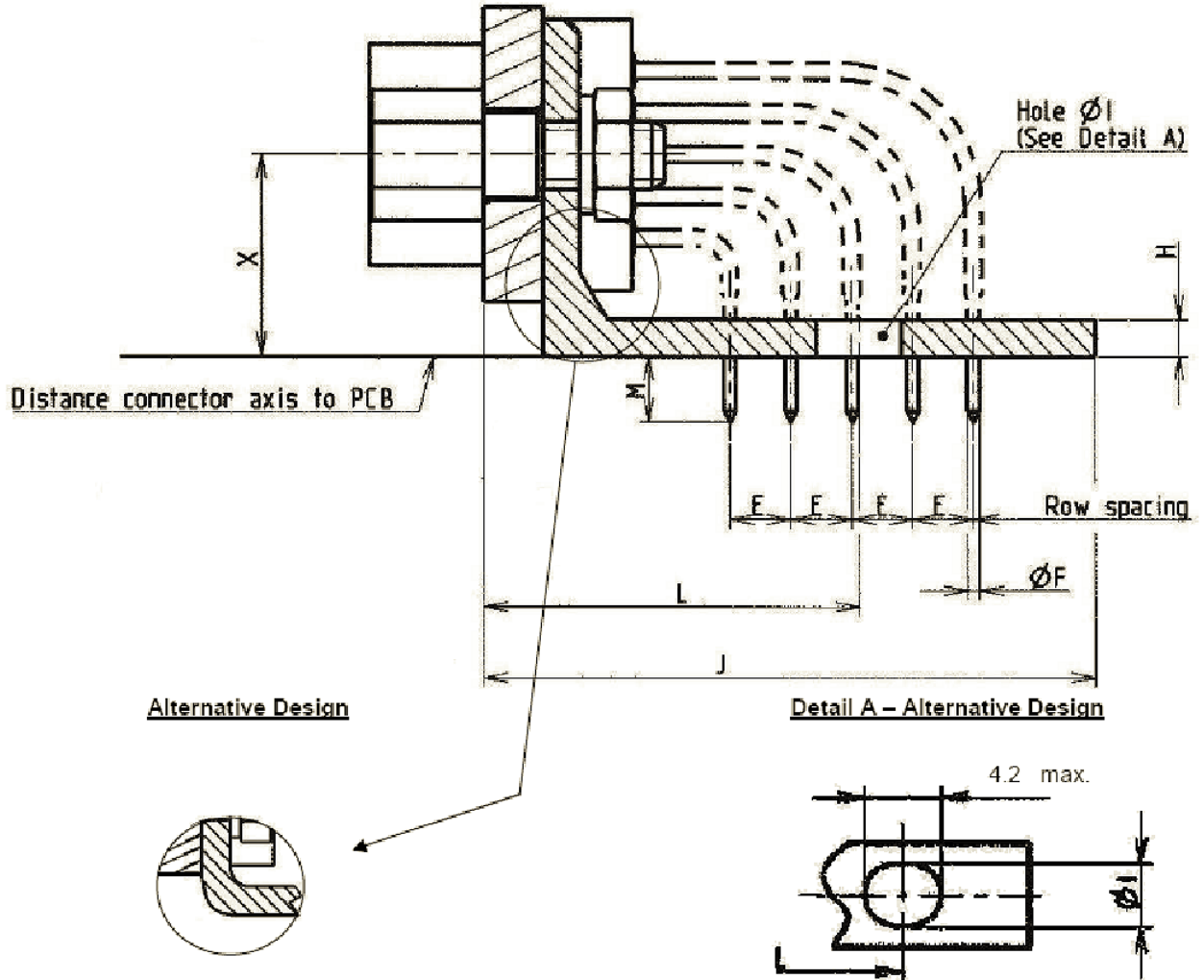

Symbol Dim.	E		ØF	H	ØI	J	L	M	X
	1A7N	1B7N							
Min	2.49	2.79	0.48	1.4	3	-	15.25	3.42	7.25
Max	2.59	2.89	0.55	2.1	3.3	25.6	15.75	4.22	7.45

NOTES:

1. All dimensions are in millimetres.
2. See Table 1(a) for size of nut.
3. Only the underlined dimensions shall be checked during procurement.

FIGURE 2(d) - MATING DIMENSIONS AND CONTACT POSITION

Mounting Condition

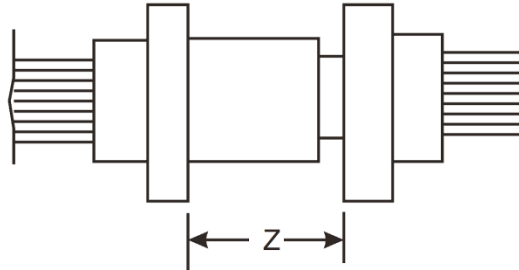

Plug Male Contact

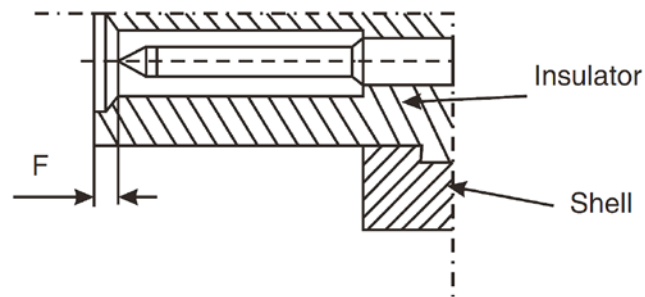

F		Z
Min	Max	Max
0.22	0.72	5.21

NOTES:

- All dimensions are in millimetres.

4 REQUIREMENTS

4.1 GENERAL

The complete requirements for procurement of the components specified herein are stated in this specification and ESCC Generic Specification No. 3401. Deviations from the Generic Specification, applicable to this specification only, are detailed in Para. 4.2.

Deviations from the Generic Specification and this Detail Specification, formally agreed with specific Manufacturers on the basis that the alternative requirements are equivalent to the ESCC requirements and do not affect the components' reliability, are listed in the appendices attached to this specification.

4.2 DEVIATIONS FROM GENERIC SPECIFICATION

4.2.1 Deviations from Special In-Process Controls

None.

4.2.2 Deviations from Final Production Tests (Chart II)

- (a) Para. 9.1.1.4, Mated Shell Conductivity: Not applicable.
- (b) Para. 9.9, Seal Test: Not applicable.

4.2.3 Deviations from Burn-in and Electrical Measurements (Chart III)

Chart III is not applicable.

4.2.4 Deviations from Qualification Tests (Chart IV)

- (a) Para. 9.1.1.4, Mated Shell Conductivity: Not applicable.
- (b) Para. 9.9, Seal Test: Not applicable.
- (c) Para. 9.15, Joint Strength: Not applicable.
- (d) Para. 9.24, Jackscrew Retention: Not applicable.
- (e) Para. 9.27, Maintenance Aging: Not applicable.
- (f) Para. 9.28, Engagement and Separation Forces: Not applicable.
- (g) Para. 9.29, Oversize Pin Exclusion: Not applicable.
- (h) Para. 9.30, Probe Damage: Not applicable.

4.2.5 Deviations from Lot Acceptance Tests (Chart V)

- (a) Para. 9.1.1.4, Mated Shell Conductivity: Not applicable.
- (b) Para. 9.9, Seal Test: Not applicable.
- (c) Para. 9.15, Joint Strength: Not applicable.
- (d) Para. 9.24, Jackscrew Retention: Not applicable.
- (e) Para. 9.27, Maintenance Aging: Not applicable.
- (f) Para. 9.28, Engagement and Separation Forces: Not applicable.
- (g) Para. 9.29, Oversize Pin Exclusion: Not applicable.
- (h) Para. 9.30, Probe Damage: Not applicable.

4.3 MECHANICAL REQUIREMENTS

4.3.1 Dimension Check

The dimensions of the connectors specified herein shall be verified in accordance with requirements set out in Para. 9.6 of ESCC Generic Specification No. 3401 and shall conform to those shown in Figure 2 of this specification.

4.3.2 Weight

The maximum weight of the connectors, contacts and accessories specified herein shall be as specified in Table 1(a).

4.3.3 Contact Capability

Not applicable.

4.3.4 Contact Retention (in Insert)

Contact retention within the insert shall be 15N.

4.3.5 Mating and Unmating Forces

The forces applied for the mating and unmating of the connectors shall conform to the values specified in Table 1(a).

4.3.6 Insert Retention (in Shell)

Connector inserts shall withstand a pressure of 34.4N/cm² applied from the mating side to the rear side.

4.3.7 Jackscrew Retention

Not applicable.

4.3.8 Contact Insertion and Withdrawal Forces

Not applicable.

4.3.9 Engagement and Separation Forces

Not applicable.

4.3.10 Oversize Pin Exclusion

Not applicable.

4.3.11 Probe Damage

Not applicable.

4.3.12 Solderability

Size A soldering iron shall be used.

4.4 MATERIALS AND FINISHES

The materials and finishes shall be as specified herein. Where a definite material is not specified, a material which will enable the connectors specified herein to meet the performance requirements of this specification shall be used. Acceptance or approval of any constituent material does not guarantee acceptance of the finished product.

4.4.1 Shells

Variant 01

Shells shall be made of glass-fibre reinforced thermoplastic. The plating shall be a minimum thickness of 1.27µm gold over 5µm minimum of electroless nickel or copper.

Variant 02

Shells shall be made of aluminium alloy. The plating shall be a minimum thickness of 1.27µm gold over 20µm minimum of electroless nickel.

4.4.2 Inserts

Inserts shall be made of thermoplastic material.

4.4.3 Contacts

Copper alloy with an underplate of 1µm minimum of nickel or copper, gold plated with 1.27µm minimum of gold.

4.4.4 Brackets

Stainless steel.

4.4.5 Accessories

As specified in ESCC Detail Specification No. [3401/084](#).

4.4.6 Magnetism Level

The allowable value of magnetism shall not exceed that specified for the relevant level (see Para. 4.5.4.3). Only magnetism levels NMC and NMD are verified.

4.5 MARKING

4.5.1 General

The marking of all components delivered to this specification shall be in accordance with the requirements of ESCC Basic Specification No. 21700 and the following paragraphs. Each component shall be marked in respect of:

- (a) Contact Position.
- (b) The ESCC Component Number.
- (c) Characteristics.
- (d) Traceability Information.

4.5.2 Contact Position

The contact positions shall be marked on the insert in accordance with Figure 2(b).

4.5.3 The ESCC Component Number

Each component shall bear the ESCC Component Number which shall be constituted and marked as follows:

Example: 340108101B

- Detail Specification Number: 3401081
- Type Variant (see Table 1(a)): 01
- Testing Level: B

4.5.4 Characteristics

The characteristics to be marked in the following order of precedence are:

- (a) Shell Size.
- (b) Contact Arrangement.
- (c) Type of Contact.
- (d) Magnetism Level (only applicable to Variant 01).
- (e) Contact Termination Code.

The information shall be constituted and marked as follows (example): C13PNMBOL3

- Shell Size: C
- Contact Arrangement: 13
- Type of Contact: P
- Magnetism Level (200 gamma): NMB
- Contact Termination Code: OL3

4.5.4.1 *Shell Size and Contact Arrangement*

Shell size shall be as designated in Table 1(a) and Figure 2(a). The shell size code also defines the contact arrangement. The layouts of the available contact arrangements are shown in Figure 2(b).

4.5.4.2 *Type of Contact*

Contact type code P indicates male (Pin) contact.

4.5.4.3 Magnetism Level

The following codes shall be used for magnetism level. Magnetism level is not applicable to Variant 02 and therefore the magnetism level code shall be omitted.

Code	Definition
NMB	Magnetism Level: ≤ 200 gamma
NMC	Magnetism Level: ≤ 20 gamma
NMD	Magnetism Level: ≤ 2 gamma

4.5.4.4 Contact Termination Code

Contact termination code shall be indicated as given in Table 1(a), Contact Types.

NOTES:

1. For connectors with contact arrangements that include coaxial or power contact cavities, the coaxial or power contacts shall be ordered separately in accordance with ESCC Detail Specification Nos. [3401/004](#) and [3401/040](#).
Coaxial and power contacts must be from the same manufacturer as the connector in which they are mounted and this shall be verified prior to assembly.

4.5.5 Traceability Information

Traceability information shall be marked in accordance with the requirements of ESCC Basic Specification No. [21700](#).

4.6 ELECTRICAL MEASUREMENTS

4.6.1 Electrical Measurements at Room Temperature

The parameters to be measured at room temperature are scheduled in Table 2. Unless otherwise specified, measurements shall be performed at $T_{amb} = +22 \pm 3$ °C.

4.6.2 Electrical Measurements at High and Low Temperatures (Table 3)

Not applicable.

4.6.3 Circuits for Electrical Measurements (Figure 4)

Not applicable.

4.7 BURN-IN AND ELECTRICAL MEASUREMENTS (TABLES 4 AND 5)

Not applicable.

TABLE 2 - ELECTRICAL MEASUREMENTS AT ROOM TEMPERATURE

No.	Characteristic	Symbol	ESCC 3401 Test Method	Test Condition	Limits		Unit
					Min	Max	
1	Insulation Resistance	R _i	Para. 9.1.1.1	Para. 9.1.1.1	5000	-	MΩ
2	Voltage Proof Leakage Current	I _L	Para. 9.1.1.2	600Vrms	-	2	mA
3	Low Level Contact Resistance	R _{cl}	Para. 9.1.1.3	Para. 9.1.1.3	-	6	mΩ
4	Rated Current Contact Resistance	R _{cr}	Para. 9.1.1.3	Table 1(b)	-	5	mΩ

TABLES 3, 4 AND 5

Not applicable.

4.8 ENVIRONMENTAL AND ENDURANCE TESTS (CHARTS IV AND V OF ESCC GENERIC SPECIFICATION NO. 3401)

4.8.1 Measurements and Inspections on Completion of Environmental Tests

The parameters to be measured and inspections to be performed on completion of environmental testing are scheduled in Table 6. Unless otherwise specified, the measurements shall be performed at T_{amb} = +22 ±3 °C.

4.8.2 Measurements and Inspections at Intermediate Points During Endurance Tests

Not applicable.

4.8.3 Measurements and Inspections on Completion of Endurance Tests

The parameters to be measured and inspections to be performed on completion of endurance testing are scheduled in Table 6. Unless otherwise specified, the measurements shall be performed at T_{amb} = +22 ±3 °C.

4.8.4 Conditions for Operating Life Test (Part of Endurance Testing) (Table 5)

Not applicable.

4.8.5 Electrical Circuit for Operating Life Test (Figure 5)

Not applicable.

4.8.6 Conditions for High Temperature Storage Test (Part of Endurance Testing)

The requirements for the high temperature storage test are specified in Section 9 of ESCC Generic Specification No. 3401. The conditions for high temperature storage testing shall be the maximum storage temperature specified in Table 1(b) of this specification.

TABLE 6 - MEASUREMENTS AND INSPECTIONS ON COMPLETION OF ENVIRONMENTAL AND ENDURANCE TESTING

No.	ESCC Generic Spec. No. 3401		Measurements and Inspections		Symbol	Limits		Unit
	Environmental and Endurance Tests (Note 1)	Test Method and Conditions	Identification	Conditions		Min	Max	
01	Vibration	Para. 9.11	Initial Measurements Coupling screw(s) Unlocking Torque	-	Tq	Record Values		Nm
			Final Measurements Full Engagement Coupling screw(s) Unlocking Torque Drift	-	$\Delta Tq/Tq$	-25	+25	%
			Visual Examination	-	-	-	-	
02	Shock or Bump	Para. 9.12	Full Engagement Visual Examination	-	-	-	-	
03	Climatic Sequence	Para. 9.13	Dry Heat Insulation Resistance	At High Temperature Table 2, Item 1 (Note 2)	R _i	10	-	MΩ
			Low Air Pressure Voltage Proof Leakage Current	Figure 1	I _L	ESCC 3401 Para. 9.13.5		mA
			Damp Heat Insulation Resistance	Immediately after test Table 2 Item 1	R _i	1	-	MΩ
			Final Measurements External Visual Inspection	After 1-24hrs Recovery ESCC 3401 Para. 9.7	-	ESCC 3401 Para. 9.7		
			Insulation Resistance	Table 2, Item 1	R _i	Table 2, Item 1		MΩ
			Voltage Proof Leakage Current	Table 2, Item 2	I _L	Table 2, Item 2		mA
04	Plating Thickness	Para. 9.14	Thickness	-	-	Para. 4.4.3 of this spec.		
05	Rapid Change of Temperature	Para. 9.16	Visual Examination	-	-	-	-	
			Insulation Resistance	Table 2, Item 1	R _i	Table 2, Item 1		MΩ
			Voltage Proof Leakage Current	Table 2, Item 2	I _L	Table 2, Item 2		mA
06	Contact Retention (in Insert)	Para. 9.17 & Para. 4.3.4 of this spec.	Contact Displacement	-	-	ESCC 3401 Para. 9.17		

No.	ESCC Generic Spec. No. 3401		Measurements and Inspections		Symbol	Limits		Unit
	Environmental and Endurance Tests (Note 1)	Test Method and Conditions	Identification	Conditions		Min	Max	
07	Endurance	Para. 9.18	Initial Measurements					
			Mating/Unmating Forces	-	F	Para. 4.3.5 of this spec.		N
			Low Level Contact Resistance	Table 2, Item 3	R _{cl}	Table 2, Item 3 Record Values		mΩ
			Final Measurements					
			Visual Examination	-	-	-	-	
			Mating/Unmating Forces	-	F	Para. 4.3.5 of this spec.		N
			Low Level Contact Resistance Drift	Table 2, Item 3	ΔR _{cl}	-	3	mΩ
Insulation Resistance	Table 2, Item 1	R _i	Table 2, Item 1		MΩ			
			Voltage Proof Leakage Current	Table 2, Item 2	I _L	Table 2, Item 2		mA
08	Permanence of Marking	Para. 9.19	As applicable	-	-	-	-	
09	Mating/Unmating Forces	Para. 9.20	Force	-	F	Para. 4.3.5 of this spec.		N
10	High Temperature Storage	Para. 9.21	Initial Measurements					
			Low Level Contact Resistance	Table 2, Item 3	R _{cl}	Table 2 Item 3 Record Values		mΩ
			Final Measurements					
			Visual Examination	-	-	-	-	
			Mating/Unmating Forces	-	F	Para. 4.3.5 of this spec.		N
			Low Level Contact Resistance Drift	Table 2, Item 3	ΔR _{cl}	-	3	mΩ
			Rated Current Contact Resistance	Table 2, Item 4	R _{cr}	-	6	mΩ
			Insulation Resistance	Table 2, Item 1	R _i	Table 2, Item 1		MΩ
Voltage Proof Leakage Current	Table 2, Item 2	I _L	Table 2, Item 2		mA			
			Contact Retention (in Insert)	Para. 4.3.4 of this spec.	-	ESCC 3401 Para. 9.17		N
11	Corrosion	Para. 9.22	Visual Examination	-	-	-	-	

No.	ESCC Generic Spec. No. 3401		Measurements and Inspections		Symbol	Limits		Unit
	Environmental and Endurance Tests (Note 1)	Test Method and Conditions	Identification	Conditions		Min	Max	
12	Insert Retention (in Shell)	Para. 9.23 & Para. 4.3.6 of this spec.	Visual Examination	-	-	Para. 4.3.6 of this spec.		
13	High Temperature Measurements	Para. 9.25	Insulation Resistance	Table 2, Item 1 (Note 2)	R_i	10	-	MΩ
14	Overload Test	Para. 9.26	Internal Temperature	-	T	-	+100	°C
			Rated Current Contact Resistance	Table 2, Item 4	R_{cr}	Table 2, Item 4		mΩ
			Insulation Resistance	Table 2, Item 1	R_i	Table 2, Item 1		MΩ
			Voltage Proof Leakage Current	Table 2, Item 2	I_L	Table 2, Item 2		mA
15	Solderability	Para. 9.31 and Para. 4.3.12 of this spec.	-	-	-	ESCC 3401 Para. 9.31		

NOTES:

1. The tests in this table refer to either Chart IV or V and shall be used as applicable.
2. $T_{amb} = +125$ °C.

APPENDIX 'A'
AGREED DEVIATIONS FOR SOURIAU (F)

Items Affected	Description of Deviations
Para. 4.2.2, Deviations from Final Production Tests (Chart II(b))	Para. 9.1.4, Electrical Measurements at Room Temperature: For all contacts, Low Level Contact Resistance and Rated Current Contact Resistance measurements, performed in accordance with Table 2 of the Detail Specification, may be omitted provided that Low Level Contact Resistance measurements are performed on 10 contacts per contact batch, in accordance with the Souriau PID requirements. The results of the Low Level Contact Resistance measurements shall be considered for PDA.