



**DIODES, POWER RECTIFIER, HIGH EFFICIENCY,  
FAST RECOVERY**

**BASED ON TYPE BYW81-200**

**ESCC Detail Specification No. 5103/029**

|          |              |
|----------|--------------|
| Issue 12 | October 2020 |
|----------|--------------|



### **LEGAL DISCLAIMER AND COPYRIGHT**

European Space Agency, Copyright © 2020. All rights reserved.

The European Space Agency disclaims any liability or responsibility, to any person or entity, with respect to any loss or damage caused, or alleged to be caused, directly or indirectly by the use and application of this ESCC publication.

This publication, without the prior permission of the European Space Agency and provided that it is not used for a commercial purpose, may be:

- copied in whole, in any medium, without alteration or modification.
- copied in part, in any medium, provided that the ESCC document identification, comprising the ESCC symbol, document number and document issue, is removed.

**DOCUMENTATION CHANGE NOTICE**

(Refer to <https://escies.org> for ESCC DCR content)

| DCR No. | CHANGE DESCRIPTION                                    |
|---------|---|
| 1365    | Specification updated to incorporate changes per DCR. |

**TABLE OF CONTENTS**

|       |  |    |
|-------|--|----|
| 1     | GENERAL  | 5  |
| 1.1   | SCOPE  | 5  |
| 1.2   | APPLICABLE DOCUMENTS                                       | 5  |
| 1.3   | TERMS, DEFINITIONS, ABBREVIATIONS, SYMBOLS AND UNITS       | 5  |
| 1.4   | THE ESCC COMPONENT NUMBER AND COMPONENT TYPE VARIANTS      | 5  |
| 1.4.1 | The ESCC Component Number                                  | 5  |
| 1.4.2 | Component Type Variants                                    | 5  |
| 1.5   | MAXIMUM RATINGS  | 6  |
| 1.6   | HANDLING PRECAUTIONS                                       | 7  |
| 1.7   | PHYSICAL DIMENSIONS AND TERMINAL IDENTIFICATION            | 8  |
| 1.7.1 | Metal Flange Mount Package (TO-254) - 3 lead               | 8  |
| 1.7.2 | Surface Mount Package (SMD.5) - 3 terminal                 | 9  |
| 1.7.3 | Notes to Physical Dimensions and Terminal Identification   | 9  |
| 1.8   | FUNCTIONAL DIAGRAM   | 10 |
| 1.9   | MATERIALS AND FINISHES                                     | 11 |
| 2     | REQUIREMENTS   | 11 |
| 2.1   | GENERAL  | 11 |
| 2.1.1 | Deviations from the Generic Specification                  | 11 |
| 2.2   | MARKING  | 11 |
| 2.3   | CASE ISOLATION   | 11 |
| 2.4   | TERMINAL STRENGTH  | 12 |
| 2.5   | ELECTRICAL MEASUREMENTS AT ROOM, HIGH AND LOW TEMPERATURES | 12 |
| 2.5.1 | Room Temperature Electrical Measurements                   | 12 |
| 2.5.2 | High and Low Temperatures Electrical Measurements          | 12 |
| 2.5.3 | Notes to Electrical Measurement Tables                     | 13 |
| 2.6   | PARAMETER DRIFT VALUES                                     | 13 |
| 2.7   | INTERMEDIATE AND END-POINT ELECTRICAL MEASUREMENTS         | 13 |
| 2.8   | HIGH TEMPERATURE REVERSE BIAS BURN-IN CONDITIONS           | 14 |
| 2.9   | POWER BURN-IN CONDITIONS                                   | 14 |
| 2.10  | OPERATING LIFE CONDITIONS                                  | 14 |
|       | APPENDIX 'A'   | 15 |

## 1 GENERAL

### 1.1 SCOPE

This specification details the ratings, physical and electrical characteristics and test and inspection data for the component type variants and/or the range of components specified below. It supplements the requirements of, and shall be read in conjunction with, the ESCC Generic Specification listed under Applicable Documents.

### 1.2 APPLICABLE DOCUMENTS

The following documents form part of this specification and shall be read in conjunction with it:

- (a) ESCC Generic Specification No. [5000](#)
- (b) [MIL-STD-750](#), Test Methods and Procedures for Semiconductor Devices

### 1.3 TERMS, DEFINITIONS, ABBREVIATIONS, SYMBOLS AND UNITS

For the purpose of this specification, the terms, definitions, abbreviations, symbols and units specified in ESCC Basic Specification No. [21300](#) shall apply.

### 1.4 THE ESCC COMPONENT NUMBER AND COMPONENT TYPE VARIANTS

#### 1.4.1 The ESCC Component Number

The ESCC Component Number shall be constituted as follows:

Example: 510302901

- Detail Specification Reference: 5103029
- Component Type Variant Number: 01 (as required)

#### 1.4.2 Component Type Variants

The component type variants applicable to this specification are as follows:

| Variant Number | Based on Type | Case   | Description                       | Lead/Terminal Material and Finish | Weight max g |
|----------------|---------------|--------|-----------------------------------|-----------------------------------|--------------|
| 01             | BYW81-200     | TO-254 | Single diode                      | H9                                | 10           |
| 02             | BYW81-200     | TO-254 | Dual diode, Common Anode          | H9                                | 10           |
| 03             | BYW81-200     | TO-254 | Dual diode, Common Cathode        | H9                                | 10           |
| 04             | BYW81-200     | TO-254 | Dual diode, series, centre tapped | H9                                | 10           |
| 05             | BYW81-200     | SMD.5  | Single diode                      | Q14                               | 2            |
| 06             | BYW81-200     | TO-254 | Dual diode, Common Anode          | H14                               | 10           |
| 07             | BYW81-200     | TO-254 | Dual diode, Common Anode          | H4                                | 10           |
| 08             | BYW81-200     | TO-254 | Dual diode, Common Cathode        | H4                                | 10           |

The lead/terminal material and finish shall be in accordance with the requirements of ESCC Basic Specification No. [23500](#).

1.5 MAXIMUM RATINGS

The maximum ratings shall not be exceeded at any time during use or storage.

Maximum ratings shall only be exceeded during testing to the extent specified in this specification and when stipulated in Test Methods and Procedures of the ESCC Generic Specification.

| Characteristics  | Symbols       | Maximum Ratings   | Unit | Remarks                      |
|--|---------------|-------------------|------|------------------------------|
| Forward Surge Current<br>Variant 01, 04 and 05<br>Variant 02, 03, 06, 07 and 08<br>(per Diode)<br>Variant 02, 03, 06, 07 and 08<br>(per Device)            | $I_{FSM}$     | 250<br>250<br>500 | A    | Notes 1, 8                   |
| Repetitive Peak Reverse Voltage  | $V_{RRM}$     | 200               | V    | Note 2                       |
| Average Output Rectified Current<br>Variant 01, 04 and 05<br>Variant 02, 03, 06, 07 and 08<br>(per Diode)<br>Variant 02, 03, 06, 07 and 08<br>(per Device) | $I_o$         | 15<br>15<br>30    | A    | 50% Duty Cycle<br>Notes 3, 8 |
| RMS Forward Current<br>Variant 01, 04 and 05<br>Variant 02, 03, 06, 07 and 08<br>(per Diode)<br>Variant 02, 03, 06, 07 and 08<br>(per Device)              | $I_{F(rms)}$  | 30<br>30<br>40    | A    | Note 8                       |
| Operating Temperature Range (Case Temperature)   | $T_{op}$      | -55 to +150       | °C   | Note 4                       |
| Junction Temperature   | $T_j$         | +150              | °C   |                              |
| Storage Temperature Range  | $T_{stg}$     | -55 to +150       | °C   | Note 4                       |
| Soldering Temperature<br>For TO-254<br>For SMD.5   | $T_{sol}$     | +260<br>+245      | °C   | Note 5<br>Note 6             |
| Thermal Resistance, Junction to Case<br>All variants (per Diode)<br>Variant 02, 03, 06, 07 and 08<br>(per Device)  | $R_{th(j-c)}$ | 2.3<br>1.4        | °C/W | Notes 7, 8                   |

**NOTES:**

1. Sinusoidal pulse of 10ms duration.
2. Pulsed, duration 5ms,  $f = 50\text{Hz}$ .
3. At  $T_{case} > +110^\circ\text{C}$ , derate linearly to 0A at  $+150^\circ\text{C}$ .
4. For Variants with hot solder dip lead finish all testing performed at  $T_{amb} > +125^\circ\text{C}$  shall be carried out in a 100% inert atmosphere.
5. Duration 10 seconds maximum at a distance of not less than 1.5mm from the device body and the same lead shall not be resoldered until 3 minutes have elapsed.

6. Duration 5 seconds maximum and the same package shall not be resoldered until 3 minutes have elapsed.
7. Package mounted on an infinite heatsink.
8. For Variants 02, 03, 06, 07 and 08 the "per Device" ratings apply only when both anode or cathode terminals are tied together.

#### 1.6 HANDLING PRECAUTIONS

The TO-254 package contains Beryllium Oxide (BeO) and therefore it must not be ground, machined, sandblasted or subjected to any mechanical operation which will produce dust. The case must not be subjected to any chemical process (e.g. etching) which will produce fumes.

1.7 PHYSICAL DIMENSIONS AND TERMINAL IDENTIFICATION

Consolidated Notes are given following the case drawings and dimensions in Para. 1.7.3.

1.7.1 Metal Flange Mount Package (TO-254) - 3 lead

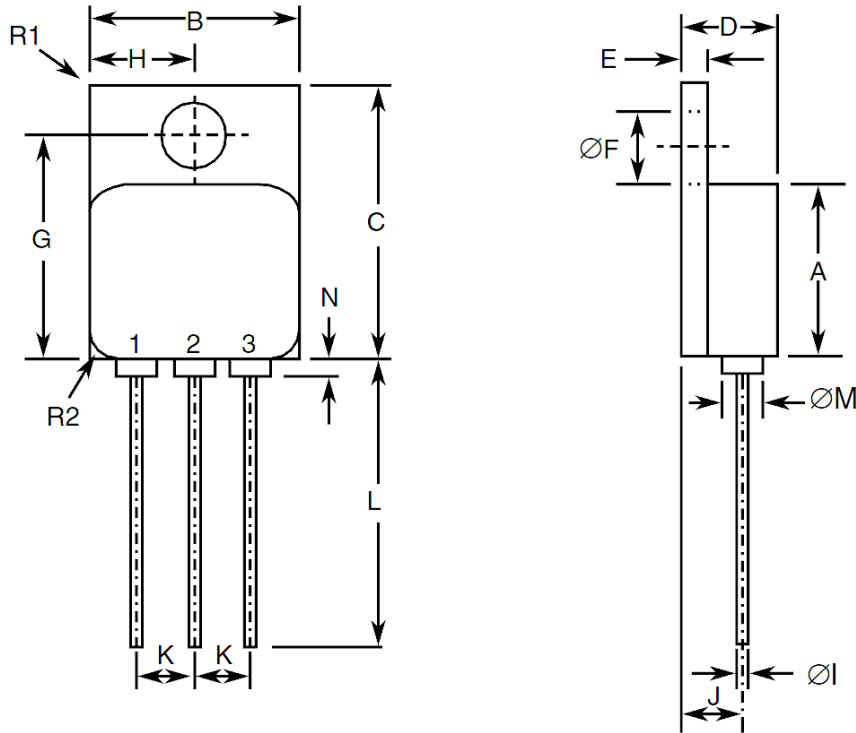

| Symbols | Dimensions mm |       | Notes |
|---------|---------------|-------|-------|
|         | Min           | Max   |       |
| A       | 13.59         | 13.84 |       |
| B       | 13.59         | 13.84 |       |
| C       | 20.07         | 20.32 |       |
| D       | 6.3           | 6.7   |       |
| E       | 1             | 1.35  |       |
| ØF      | 3.5           | 3.9   |       |
| G       | 16.89         | 17.4  |       |
| H       | 6.86 BSC      |       |       |
| ØI      | 0.89          | 1.14  | 2     |
| J       | 3.81 BSC      |       |       |
| K       | 3.81 BSC      |       |       |
| L       | 12.95         | 14.5  |       |
| ØM      | 3.05 Typical  |       | 2     |
| N       | -             | 0.71  | 2     |
| R1      | -             | 1     | 3     |
| R2      | 1.65 Typical  |       | 4     |



1.7.2 Surface Mount Package (SMD.5) - 3 terminal

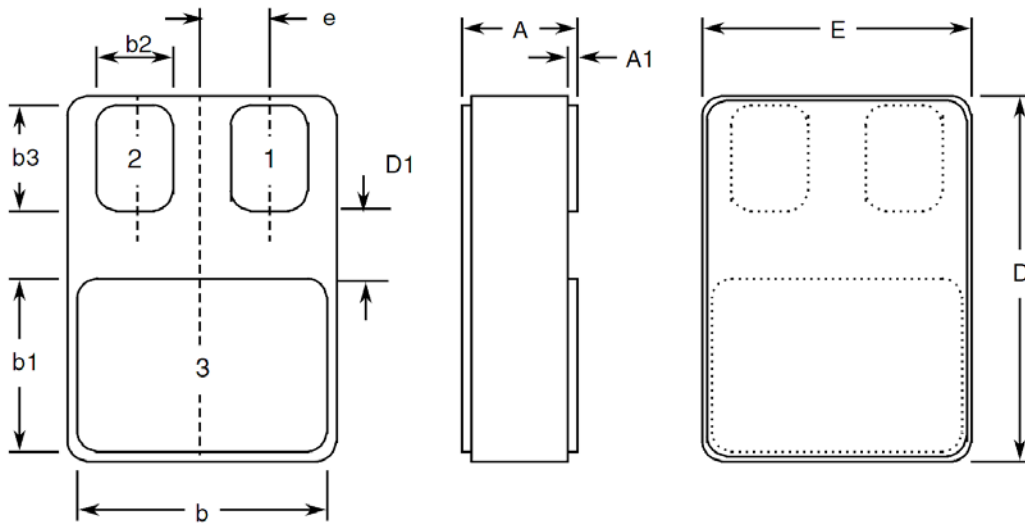

| Symbols | Dimensions mm |       | Notes |
|---------|---------------|-------|-------|
|         | Min           | Max   |       |
| A       | 2.84          | 3.15  |       |
| A1      | 0.25          | 0.51  |       |
| B       | 7.13          | 7.39  |       |
| b1      | 5.58          | 5.84  |       |
| b2      | 2.28          | 2.54  | 5     |
| b3      | 2.92          | 3.18  | 5     |
| D       | 10.03         | 10.28 |       |
| D1      | 0.76          | -     | 5     |
| E       | 7.39          | 7.64  |       |
| E       | 1.91 BSC      |       | 5     |

1.7.3 Notes to Physical Dimensions and Terminal Identification

1. The terminal identification is specified by the components geometry. See Para. 1.8 Functional Diagram for the terminal connections.
2. 3 places.
3. Radius of heatsink flange corner, 4 places.
4. Radius of body corner, 4 places.
5. 2 places.

1.8 FUNCTIONAL DIAGRAM

Variant 01

Terminal 1: Cathode  
Terminal 2: No connection  
Terminal 3: Anode

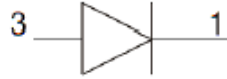

Variant 02, 06 and 07

Terminal 1: Cathode a  
Terminal 2: Common Anode  
Terminal 3: Cathode b

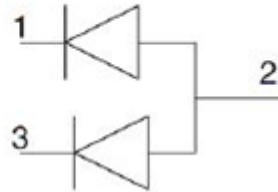

Variant 03 and 08

Terminal 1: Anode a  
Terminal 2: Common Cathode  
Terminal 3: Anode b

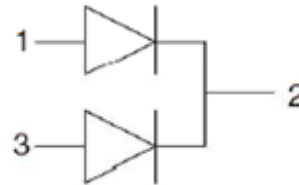

Variant 04

Terminal 1: Anode a  
Terminal 2: Centre Tap  
Terminal 3: Cathode b

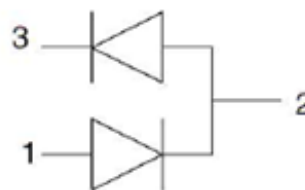

Variant 05

Terminals 1 and 2: Anode  
Terminal 3: Cathode

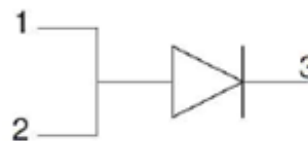

**NOTES:**

1. For TO-254, the case is not connected to any lead.
2. For SMD.5, the lid is not connected to any terminal.

## 1.9 MATERIALS AND FINISHES

Materials and finishes shall be as follows:

### (a) Case

For the metal flange mount package the case shall be hermetically sealed and have a metal body. The leads pass through ceramic eyelets brazed into the frame and the lid shall be welded.

For the surface mount package the case shall be hermetically sealed and have a ceramic body with a Kovar lid.

### (b) Leads/Terminals

As specified in Para. 1.4.2.

## 2 REQUIREMENTS

### 2.1 GENERAL

The complete requirements for procurement of the components specified herein are as stated in this specification and the ESCC Generic Specification. Permitted deviations from the Generic Specification, applicable to this specification only, are listed below.

Permitted deviations from the Generic Specification and this Detail Specification, formally agreed with specific Manufacturers on the basis that the alternative requirements are equivalent to the ESCC requirement and do not affect the component's reliability, are listed in the appendices attached to this specification.

#### 2.1.1 Deviations from the Generic Specification

None.

### 2.2 MARKING

The marking shall be in accordance with the requirements of ESCC Basic Specification No. [21700](#) and as follows.

The information to be marked on the component shall be:

- (a) The ESCC qualified components symbol (for ESCC qualified components only).
- (b) The ESCC Component Number (see Para. 1.4.1).
- (c) Traceability information.
- (d) Warning sign for Beryllium Oxide (TO-254 only).

### 2.3 CASE ISOLATION

For Variants 01, 02, 03, 04, 06, 07 and 08, Case Isolation shall be performed as specified in the ESCC Generic Specification and as follows:

- Test Conditions:
  - Test voltage: 500Vdc
  - Duration of application of test voltage: 1s
  - Points of application of test voltage: between case metal tab and all terminals connected together.
  - Maximum leakage current: 10nA

2.4 TERMINAL STRENGTH

The test conditions for Terminal Strength, tested as specified in the ESCC Generic Specification, shall be as follows:

For TO-254, Test Condition: A, tension, with an applied force of 10N for a duration of 10s.

2.5 ELECTRICAL MEASUREMENTS AT ROOM, HIGH AND LOW TEMPERATURES

Electrical measurements shall be performed at room, high and low temperatures. Consolidated notes are given in Para. 2.5.3.

2.5.1 Room Temperature Electrical Measurements

The measurements shall be performed at  $T_{amb} = +22 \pm 3^{\circ}C$ .

| Characteristics                     | Symbols       | MIL-STD-750<br>Test Method | Test Conditions<br>Note 1  | Limits                                |     | Units         |
|-------------------------------------|---------------|----------------------------|--|---------------------------------------|-----|---------------|
|                                     |               |                            |  | Min                                   | Max |               |
| Reverse Current                     | $I_R$         | 4016                       | DC Method<br>$V_R = 200V$  | -                                     | 20  | $\mu A$       |
| Forward Voltage                     | $V_{F1}$      | 4011                       | Pulse Method<br>$I_F = 10A$ , Note 2   | -                                     | 1   | V             |
|                                     | $V_{F2}$      | 4011                       | Pulse Method<br>$I_F = 20A$ , Note 2   | -                                     | 1.2 | V             |
| Breakdown Voltage                   | $V_{(BR)}$    | 4021                       | $I_R = 100\mu A$   | 200                                   | -   | V             |
| Capacitance                         | C             | 4001                       | $V_R = 10V$<br>$f = 1MHz$  | -                                     | 220 | pF            |
| Reverse Recovery Time               | $t_{rr}$      | 4031                       | Test Condition A<br>$I_F = 1A$<br>$V_R = 30V$<br>$dI_F/dt = -50A/\mu s$              | -                                     | 40  | ns            |
| Thermal Impedance, Junction to Case | $Z_{th(j-c)}$ | 3101                       | $I_H = 15$ to $40A$<br>$t_H = 50ms$<br>$I_M = 50mA$<br>$t_{md} = 100\mu s$<br>Note 3 | (Calculate $\Delta V_F$ , see Note 4) |     | $^{\circ}C/W$ |

2.5.2 High and Low Temperatures Electrical Measurements

| Characteristics   | Symbols  | MIL-STD-750<br>Test Method | Test Conditions<br>Notes 1 and 5   | Limits |      | Units |
|-------------------|----------|----------------------------|--|--------|------|-------|
|                   |          |                            |  | Min    | Max  |       |
| Reverse Current   | $I_R$    | 4016                       | $T_{case} = +125 (+0 -5)^{\circ}C$<br>DC Method<br>$V_R = 200V$            | -      | 10   | mA    |
| Forward Voltage 1 | $V_{F1}$ | 4011                       | $T_{case} = +125 (+0 -5)^{\circ}C$<br>Pulse Method<br>$I_F = 10A$ , Note 2 | -      | 0.85 | V     |
|                   |          |                            | $T_{case} = -55 (+5 -0)^{\circ}C$<br>Pulse Method<br>$I_F = 10A$ , Note 2  | -      | 1.15 | V     |

2.5.3 Notes to Electrical Measurement Tables

1. Measurements per each diode.
2. Pulse Width  $\leq 680\mu\text{s}$ , Duty Cycle  $\leq 2\%$ .
3. Performed only during Screening Tests Parameter Drift Values (Initial Measurements), go-no-go.
4. The limits for  $\Delta V_F$  shall be defined by the Manufacturer on every lot in accordance with [MIL-STD-750 Method 3101](#) and shall guarantee the  $R_{th(j-c)}$  limits specified in Para. 1.5 Maximum Ratings.
5. Read and record measurements shall be performed on a sample of 5 components with 0 failures allowed. Alternatively a 100% inspection may be performed.

2.6 PARAMETER DRIFT VALUES

Unless otherwise specified, the measurements shall be performed at  $T_{amb} = +22 \pm 3^\circ\text{C}$ .

The test methods and test conditions shall be as per the corresponding test defined in Para. 2.5.1, Room Temperature Electrical Measurements.

The drift values ( $\Delta$ ) shall not be exceeded for each characteristic specified. The corresponding absolute limit values for each characteristic shall not be exceeded.

| Characteristics   | Symbols  | Limits                           |          | Units |               |
|-------------------|----------|----------------------------------|----------|-------|---------------|
|                   |          | Drift Value $\Delta$             | Absolute |       |               |
|                   |          |                                  | Min      |       | Max           |
| Reverse Current   | $I_R$    | $\pm 2$<br>or (1)<br>$\pm 100\%$ | -        | 20    | $\mu\text{A}$ |
| Forward Voltage 1 | $V_{F1}$ | $\pm 0.05$                       | -        | 1     | V             |

**NOTES:**

1. Whichever is the greater referred to the initial value.

2.7 INTERMEDIATE AND END-POINT ELECTRICAL MEASUREMENTS

Unless otherwise specified, the measurements shall be performed at  $T_{amb} = +22 \pm 3^\circ\text{C}$ .

The test methods and test conditions shall be as per the corresponding test defined in Para. 2.5.1, Room Temperature Electrical Measurements.

The limit values for each characteristic shall not be exceeded.

| Characteristics   | Symbols  | Limits |     | Units         |
|-------------------|----------|--------|-----|---------------|
|                   |          | Min    | Max |               |
| Reverse Current   | $I_R$    | -      | 20  | $\mu\text{A}$ |
| Forward Voltage 1 | $V_{F1}$ | -      | 1   | V             |

**2.8 HIGH TEMPERATURE REVERSE BIAS BURN-IN CONDITIONS**

| Characteristics     | Symbols   | Limits       | Units |
|---------------------|-----------|--------------|-------|
| Ambient Temperature | $T_{amb}$ | +150 (+0 -5) | °C    |
| Reverse Voltage     | $V_R$     | 160          | V     |
| Duration            | $t$       | ≥ 48         | hours |

**2.9 POWER BURN-IN CONDITIONS**

| Characteristics                  | Symbols    | Test Conditions    | Units |
|----------------------------------|------------|--------------------|-------|
| Case Temperature                 | $T_{case}$ | +125 ±15<br>Note 1 | °C    |
| Junction Temperature             | $T_j$      | +150 (+0 -5)       | °C    |
| Average Output Rectified Current | $I_o$      | Notes 1, 2         | A     |

**NOTES:**

1. The case temperature and/or output current may be adjusted, within their given limit ranges, to attain the specified junction temperature.
2. Both diodes shall be tied together for common anode and common cathode variants:  
 $I_o \geq 3.75A$  for each leg of Variants 02, 03, 06, 07 and 08.  
 $I_o \geq 3.75A$  for Variants 01, 04 and 05.

**2.10 OPERATING LIFE CONDITIONS**

The conditions shall be as specified in Para. 2.9 Power Burn-in Conditions.

**APPENDIX 'A'**  
**AGREED DEVIATIONS FOR STMICROELECTRONICS (F)**

| ITEMS AFFECTED   | DESCRIPTION OF DEVIATIONS   |
|--|---|
| Para. 2.1.1, Deviations from the Generic Specification:<br>Para. 8, Test Methods and Procedures          | For qualification and qualification maintenance, or procurement of qualified or unqualified components, the following replacement test method specifications shall be used instead of the following ESCC Basic Specifications: <ul style="list-style-type: none"> <li>• No. 20400, Internal Visual Inspection: replaced by <a href="#">MIL-STD-750 Test Method 2078</a>.</li> <li>• No. 20500, External Visual Inspection: replaced by <a href="#">MIL-STD-750 Test Method 2071</a>.</li> <li>• No. 20900, Radiographic Inspection of Electronic Components: replaced by <a href="#">MIL-STD-750 Test Method 2076</a>.</li> </ul> |
| Para. 2.1.1, Deviations from the Generic Specification:<br>Deviations from Production Control - Chart F2 | Special In-Process Controls - Internal Visual Inspection.<br>Wedge bonds equal to 1.1 wire diameters are acceptable for bonding with a V-Groove tool.   |
| Para. 2.1.1, Deviations from the Generic Specification:<br>Deviations from Screening Tests - Chart F3    | Solderability is not applicable unless specifically stipulated in the Purchase Order.   |