



**DIODES, MICROWAVE, GALLIUM ARSENIDE,
HIGH CAPACITANCE TUNING VARACTOR,
BASED ON TYPES ML4519, ML4520, ML4539,
ML4540, ML4559 AND ML4560
ESCC Detail Specification No. 5512/014**

**ISSUE 1
October 2002**



	ESCC Detail Specification		PAGE ii ISSUE 1
--	---------------------------	--	--------------------

LEGAL DISCLAIMER AND COPYRIGHT

European Space Agency, Copyright © 2002. All rights reserved.

The European Space Agency disclaims any liability or responsibility, to any person or entity, with respect to any loss or damage caused, or alleged to be caused, directly or indirectly by the use and application of this ESCC publication.

This publication, without the prior permission of the European Space Agency and provided that it is not used for a commercial purpose, may be:

- copied in whole in any medium without alteration or modification.
- copied in part, in any medium, provided that the ESCC document identification, comprising the ESCC symbol, document number and document issue, is removed.



europaean space agency
agence spatiale européenne

Pages 1 to 28

**DIODES, MICROWAVE, GALLIUM ARSENIDE,
HIGH CAPACITANCE TUNING VARACTOR,
BASED ON TYPES ML4519, ML4520, ML4539,
ML4540, ML4559 AND ML4560
ESA/SCC Detail Specification No. 5512/014**



**space components
coordination group**

Issue/Rev.	Date	Approved by	
		SCCG Chairman	ESA Director General or his Deputy
Issue 1	April 1993	<i>Pommes</i>	<i>[Signature]</i>
Revision 'A'	February 1994	<i>Pommes</i>	<i>[Signature]</i>

DOCUMENTATION CHANGE NOTICE

Rev. Letter	Rev. Date	Reference	CHANGE Item	Approved DCR No.
'A'	Feb.'94	P1. Cover Page P2. DCN P22. Table 3 : Table amended		None None 221057



		<p>ESA/SCC Detail Specification No. 5512/014</p>	<p>PAGE 3 ISSUE 1</p>
---	---	--	---------------------------

TABLE OF CONTENTS

	<u>Page</u>
1. <u>GENERAL</u>	5
1.1 Scope	5
1.2 Type Variants	5
1.3 Maximum Ratings	5
1.4 Parameter Derating Information	5
1.5 Physical Dimensions	5
1.6 Functional Diagram	5
1.7 Handling Precautions	5
2. <u>APPLICABLE DOCUMENTS</u>	5
3. <u>TERMS, DEFINITIONS, ABBREVIATIONS, SYMBOLS AND UNITS</u>	5
4. <u>REQUIREMENTS</u>	17
4.1 General	17
4.2 Deviations from Generic Specification	17
4.2.1 Deviations from Special In-process Controls	17
4.2.2 Deviations from Final Production Tests	17
4.2.3 Deviations from Burn-in and Electrical Measurements	17
4.2.4 Deviations from Qualification Tests	17
4.2.5 Deviations from Lot Acceptance Tests	17
4.3 Mechanical and Environmental Requirements	17
4.3.1 Dimension Check	17
4.3.2 Weight	18
4.3.3 Terminal Strength	18
4.3.4 Bond Strength	19
4.3.5 Die Shear	19
4.4 Materials and Finishes	19
4.4.1 Case	19
4.4.2 Lead Materials and Finish	19
4.5 Marking	19
4.5.1 General	19
4.5.2 Cathode Identification	20
4.5.3 The SCC Component Number	20
4.5.4 Traceability Information	20
4.6 Electrical Measurements	20
4.6.1 Electrical Measurements at Room Temperature	20
4.6.2 Electrical Measurements at High and Low Temperatures	20
4.6.3 Circuits for Electrical Measurements	20
4.7 Burn-in Tests	20
4.7.1 Parameter Drift Values	20
4.7.2 Conditions for High Temperature Reverse Bias Burn-in	20
4.7.3 Electrical Circuit for High Temperature Reverse Bias Burn-in	20
4.8 Environmental and Endurance Tests	25
4.8.1 Electrical Measurements on Completion of Environmental Tests	25
4.8.2 Electrical Measurements at Intermediate Points and on Completion of Endurance Tests	25
4.8.3 Conditions for Operating Life Tests	25
4.8.4 Electrical Circuits for Operating Life Tests	25
4.9 Total Dose Irradiation Testing	25
4.9.1 Application	25
4.9.2 Bias Conditions	25
4.9.3 Electrical Measurements	25
4.10 Special Testing	25

**TABLES**Page



1(a)	Type Variants	6
1(b)	Maximum Ratings	9
2	Electrical Measurements at Room Temperature - D.C. Parameters	21
	Electrical Measurements at Room Temperature - A.C. Parameters	21
3	Electrical Measurements at High and Low Temperatures	22
4	Parameter Drift Values	22
5(a)	Conditions for High Temperature Reverse Bias Burn-in	24
5(b)	Conditions for Operating Life Tests	24
6	Electrical Measurements at Intermediate Points and on Completion of Endurance Testing	26
7	Electrical Measurements During and on Completion of Irradiation Testing	27

FIGURES

1	Parameter Derating Information	9
2	Physical Dimensions	10
3	Functional Diagram	16
4	Circuits for Electrical Measurements	23
5	Electrical Circuit for High Temperature Reverse Bias Burn-in and Operating Life Tests	24
6	Bias Conditions for Irradiation Testing	26

APPENDICES (Applicable to specific Manufacturers only)

'A'	Agreed Deviations for M/A-Com Ltd. (G.B.)	28
-----	---	----

 	<p style="text-align: center;">ESA/SCC Detail Specification No. 5512/014</p>	<p>PAGE 5 ISSUE 1</p>
--	--	---------------------------

1. GENERAL

1.1 SCOPE

This specification details the ratings, physical and electrical characteristics, test and inspection data for a Diode, Microwave, Gallium Arsenide, High Capacitance Tuning Varactor, based on Types ML4519, ML4520, ML4539, ML4540, ML4559 and ML4560. It shall be read in conjunction with ESA/SCC Generic Specification No. 5010, the requirements of which are supplemented herein.

1.2 TYPE VARIANTS

Variants of the basic diodes specified herein, which are also covered by this specification are given in Table 1(a).

1.3 MAXIMUM RATINGS

The maximum ratings, which shall not be exceeded at any time during use or storage, applicable to the diodes specified herein, are as scheduled in Table 1(b).

1.4 PARAMETER DERATING INFORMATION

The derating information applicable to the diodes specified herein is shown in Figure 1.

1.5 PHYSICAL DIMENSIONS

The physical dimensions of the diodes specified herein are shown in Figure 2.

1.6 FUNCTIONAL DIAGRAM

The functional diagram, showing lead identification, of the diodes specified herein, is shown in Figure 3.

1.7 HANDLING PRECAUTIONS

These devices are susceptible to damage by electrostatic discharge. Therefore, suitable precautions shall be employed for protection during all phases of manufacture, testing, packaging, shipment and any handling.

These components are Categorised as Class 2 with a Minimum Critical Path Failure Voltage of 3000V.

2. APPLICABLE DOCUMENTS

The following documents form part of this specification and shall be read in conjunction with it:-

- (a) ESA/SCC Generic Specification No. 5010 for Discrete Microwave Semiconductor Components.
- (b) MIL-STD-750, Test Methods and Procedures for Semiconductor Devices.

3. TERMS, DEFINITIONS, ABBREVIATIONS, SYMBOLS AND UNITS

For the purpose of this specification, the terms, definitions, abbreviations, symbols and units specified in ESA/SCC Basic Specification No. 21300 shall apply.



TABLE 1(a) - TYPE VARIANTS

(1) VARIANT	(2) BASED ON TYPE	(3) FIGURE	(4) TOTAL CAPACITANCE C_T (pF)		(5) QUALITY FACTOR (Q) (MINIMUM)	(6) BODY-LID AND LEAD MATERIAL AND FINISH
			MIN	MAX		
01	ML4519 - 30	2(a)	4.00	4.99	6000	A7-D2
02	ML4519 - 31	2(b)	4.00	4.99	6000	A7-D2
03	ML4519 - 33	2(c)	4.00	4.99	6000	A7
04	ML4519 - 36	2(d)	4.00	4.99	6000	A7-D2
05	ML4519 - 94	2(e)	4.00	4.99	6000	A7-D2
06	ML4519 - 95	2(f)	4.00	4.99	6000	A7-D2
07	ML4519 - 96	2(g)	4.00	4.99	6000	A7-D2
08	ML4519 - 97	2(h)	4.00	4.99	6000	A7-D2
09	ML4519 - 103	2(i)	4.00	4.99	6000	A7-D2
10	ML4519 - 118	2(j)	4.00	4.99	6000	A7
11	ML4519 - 120	2(k)	4.00	4.99	6000	D2
12	ML4519 - 186	2(l)	4.00	4.99	6000	D2
13	ML4519 - 276	2(m)	4.00	4.99	6000	D2
14	ML4520 - 30	2(a)	5.00	5.99	6000	A7-D2
15	ML4520 - 31	2(b)	5.00	5.99	6000	A7-D2
16	ML4520 - 33	2(c)	5.00	5.99	6000	A7
17	ML4520 - 36	2(d)	5.00	5.99	6000	A7-D2
18	ML4520 - 94	2(e)	5.00	5.99	6000	A7-D2
19	ML4520 - 95	2(f)	5.00	5.99	6000	A7-D2
20	ML4520 - 96	2(g)	5.00	5.99	6000	A7-D2
21	ML4520 - 97	2(h)	5.00	5.99	6000	A7-D2
22	ML4520 - 103	2(i)	5.00	5.99	6000	A7-D2
23	ML4520 - 118	2(j)	5.00	5.99	6000	A7
24	ML4520 - 120	2(k)	5.00	5.99	6000	D2
25	ML4520 - 186	2(l)	5.00	5.99	6000	D2
26	ML4520 - 276	2(m)	5.00	5.99	6000	D2
27	ML4539 - 30	2(a)	4.00	4.99	5000	A7-D2
28	ML4539 - 31	2(b)	4.00	4.99	5000	A7-D2
29	ML4539 - 33	2(c)	4.00	4.99	5000	A7
30	ML4539 - 36	2(d)	4.00	4.99	5000	A7-D2
31	ML4539 - 94	2(e)	4.00	4.99	5000	A7-D2
32	ML4539 - 95	2(f)	4.00	4.99	5000	A7-D2
33	ML4539 - 96	2(g)	4.00	4.99	5000	A7-D2
34	ML4539 - 97	2(h)	4.00	4.99	5000	A7-D2
35	ML4539 - 103	2(i)	4.00	4.99	5000	A7-D2
36	ML4539 - 118	2(j)	4.00	4.99	5000	A7



TABLE 1(a) - TYPE VARIANTS (CONT'D)

(1) VARIANT	(2) BASED ON TYPE	(3) FIGURE	(4) TOTAL CAPACITANCE C _T (pF)		(5) QUALITY FACTOR (Q) (MINIMUM)	(6) BODY-LID AND LEAD MATERIAL AND FINISH
			MIN	MAX		
37	ML4539 - 120	2(k)	4.00	4.99	5000	D2
38	ML4539 - 186	2(l)	4.00	4.99	5000	D2
39	ML4539 - 276	2(m)	4.00	4.99	5000	D2
40	ML4540 - 30	2(a)	5.00	5.99	5000	A7-D2
41	ML4540 - 31	2(b)	5.00	5.99	5000	A7-D2
42	ML4540 - 33	2(c)	5.00	5.99	5000	A7
43	ML4540 - 36	2(d)	5.00	5.99	5000	A7-D2
44	ML4540 - 94	2(e)	5.00	5.99	5000	A7-D2
45	ML4540 - 95	2(f)	5.00	5.99	5000	A7-D2
46	ML4540 - 96	2(g)	5.00	5.99	5000	A7-D2
47	ML4540 - 97	2(h)	5.00	5.99	5000	A7-D2
48	ML4540 - 103	2(i)	5.00	5.99	5000	A7-D2
49	ML4540 - 118	2(j)	5.00	5.99	5000	A7
50	ML4540 - 120	2(k)	5.00	5.99	5000	D2
51	ML4540 - 186	2(l)	5.00	5.99	5000	D2
52	ML4540 - 276	2(m)	5.00	5.99	5000	D2
53	ML4559 - 30	2(a)	4.00	4.99	4000	A7-D2
54	ML4559 - 31	2(b)	4.00	4.99	4000	A7-D2
55	ML4559 - 33	2(c)	4.00	4.99	4000	A7
56	ML4559 - 36	2(d)	4.00	4.99	4000	A7-D2
57	ML4559 - 94	2(e)	4.00	4.99	4000	A7-D2
58	ML4559 - 95	2(f)	4.00	4.99	4000	A7-D2
59	ML4559 - 96	2(g)	4.00	4.99	4000	A7-D2
60	ML4559 - 97	2(h)	4.00	4.99	4000	A7-D2
61	ML4559 - 103	2(i)	4.00	4.99	4000	A7-D2
62	ML4559 - 118	2(j)	4.00	4.99	4000	A7
63	ML4559 - 120	2(k)	4.00	4.99	4000	D2
64	ML4559 - 186	2(l)	4.00	4.99	4000	D2
65	ML4559 - 276	2(m)	4.00	4.99	4000	D2
66	ML4560 - 30	2(a)	5.00	5.99	4000	A7-D2
67	ML4560 - 31	2(b)	5.00	5.99	4000	A7-D2
68	ML4560 - 33	2(c)	5.00	5.99	4000	A7
69	ML4560 - 36	2(d)	5.00	5.99	4000	A7-D2
70	ML4560 - 94	2(e)	5.00	5.99	4000	A7-D2
71	ML4560 - 95	2(f)	5.00	5.99	4000	A7-D2
72	ML4560 - 96	2(g)	5.00	5.99	4000	A7-D2

**ESCC**ESA/SCC Detail Specification
No. 5512/014

PAGE 8

ISSUE 1

TABLE 1(a) - TYPE VARIANTS (CONT'D)

(1) VARIANT	(2) BASED ON TYPE	(3) FIGURE	(4) TOTAL CAPACITANCE C_T (pF)		(5) QUALITY FACTOR (Q) (MINIMUM)	(6) BODY-LID AND LEAD MATERIAL AND FINISH
			MIN	MAX		
73	ML4560 - 97	2(h)	5.00	5.99	4000	A7-D2
74	ML4560 - 103	2(i)	5.00	5.99	4000	A7-D2
75	ML4560 - 118	2(j)	5.00	5.99	4000	A7
76	ML4560 - 120	2(k)	5.00	5.99	4000	D2
77	ML4560 - 186	2(l)	5.00	5.99	4000	D2
78	ML4560 - 276	2(m)	5.00	5.99	4000	D2



TABLE 1(b) - MAXIMUM RATINGS

No.	CHARACTERISTIC	SYMBOL	MAXIMUM RATINGS	UNIT	REMARKS
1	D.C. Reverse Voltage Variants 01 to 26 Variants 27 to 52 Variants 53 to 78	V_R	- 30 - 45 - 60	V	Note 1
2	Operating Temperature Range	T_{op}	- 40 to + 125	°C	T_{amb}
3	Storage Temperature Range	T_{stg}	- 55 to + 125	°C	
4	Soldering Temperature	T_{sol}	+ 230	°C	Note 2

NOTES

1. Measured at $I_R = 10\mu A$ and $T_{amb} = +50^\circ C$. For derating at $T_{amb} > +50^\circ C$, see Figure 1.
2. Duration 5 seconds maximum (at a distance of not less than 1.5mm from the body for Variants 12, 13, 25, 26, 38, 39, 51, 52, 64, 65, 77 and 78) and the same termination shall not be resoldered until 3 minutes have elapsed.

FIGURE 1 - PARAMETER DERATING INFORMATION

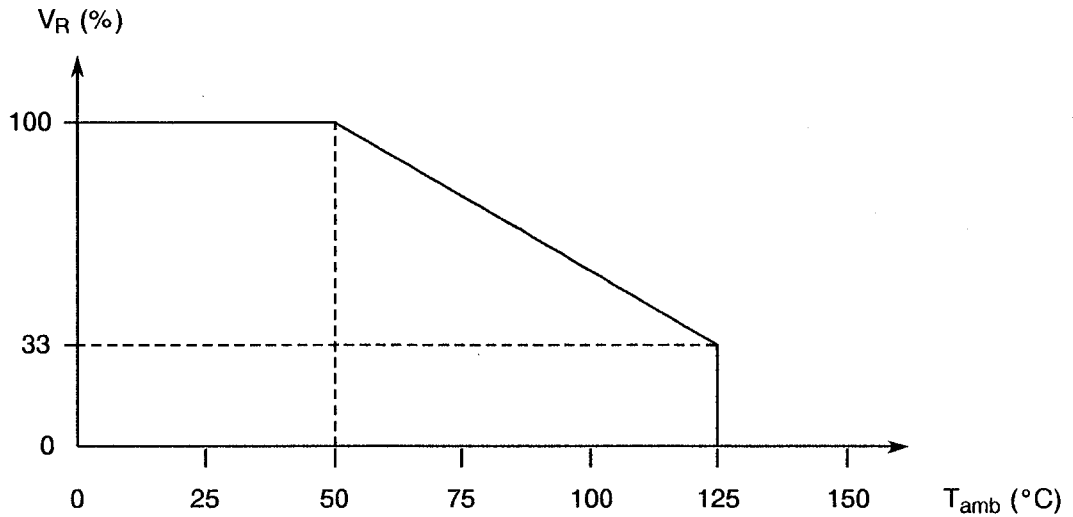

V_R versus Temperature



FIGURE 2 - PHYSICAL DIMENSIONS

FIGURE 2(a) - VARIANTS 01, 14, 27, 40, 53, 66

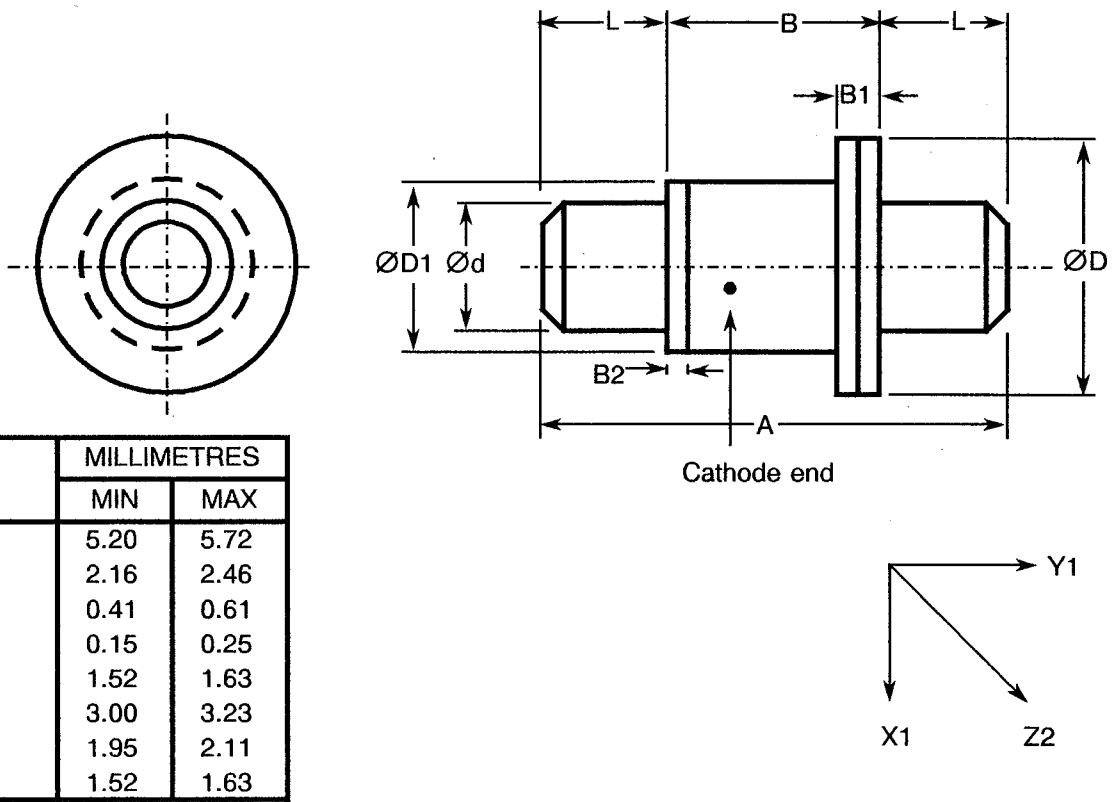

FIGURE 2(b) - VARIANTS 02, 15, 28, 41, 54, 67

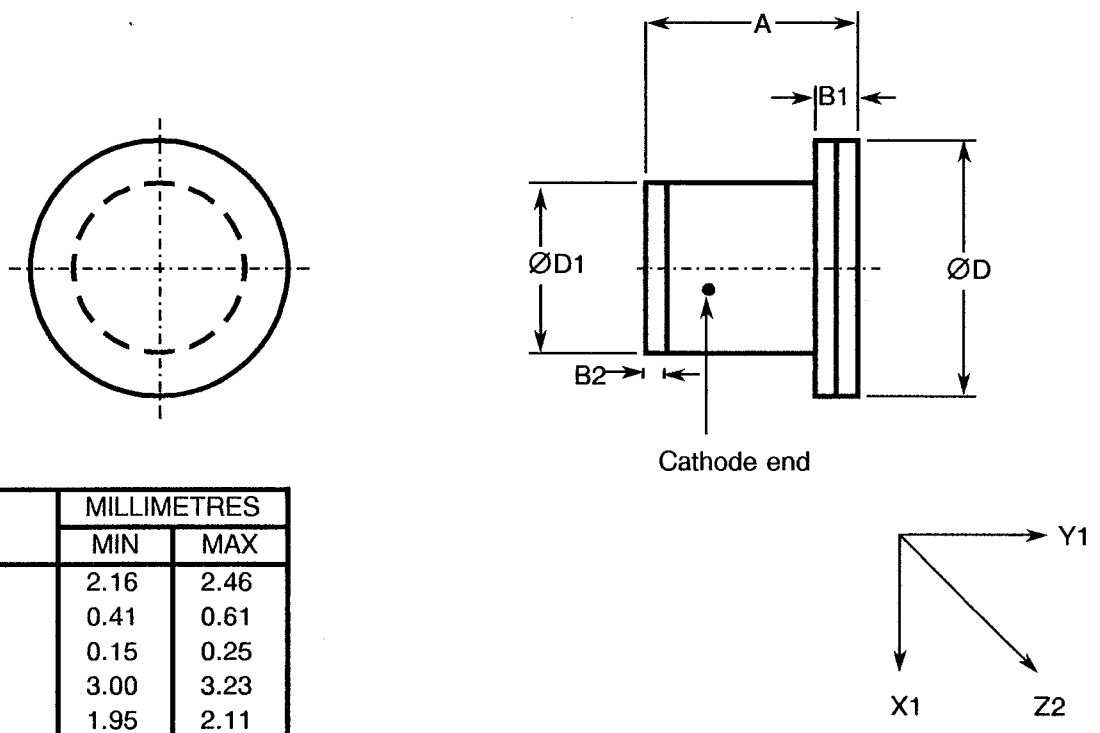
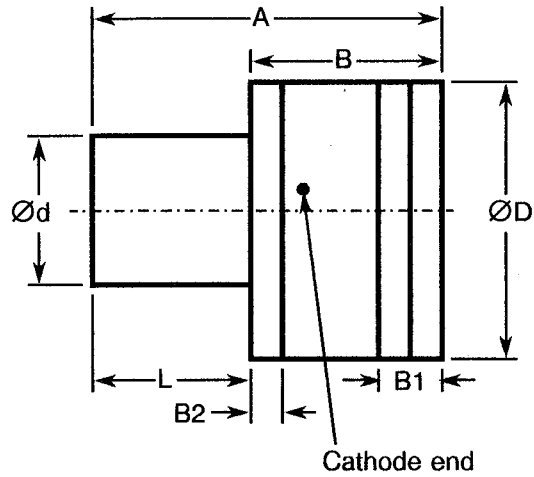
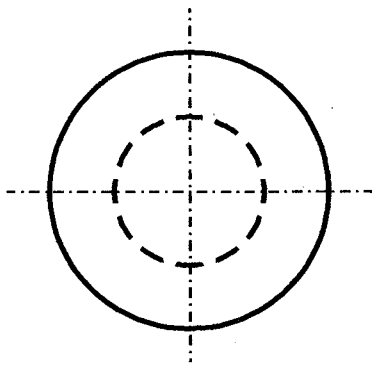



FIGURE 2 - PHYSICAL DIMENSIONS (CONTINUED)

FIGURE 2(c) - VARIANTS 03, 16, 29, 42, 55, 68



SYMBOL	MILLIMETRES	
	MIN	MAX
A	1.41	1.85
B	0.69	1.02
B1	0.30	0.50
B2	0.05	0.13
Ød	0.61	0.66
ØD	1.22	1.32
L	0.74	0.79

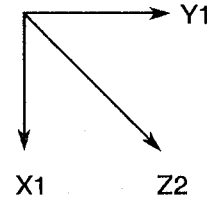
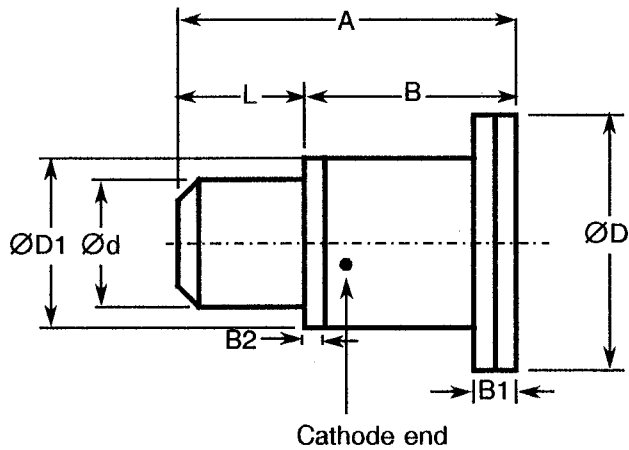
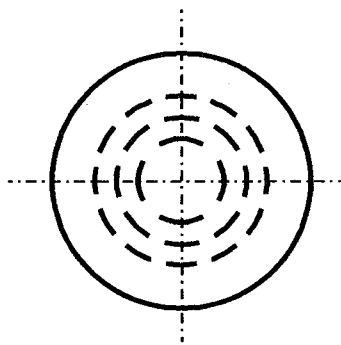

FIGURE 2(d) - VARIANTS 04, 17, 30, 43, 56, 69



SYMBOL	MILLIMETRES	
	MIN	MAX
A	3.60	4.18
B	2.16	2.46
B1	0.41	0.61
B2	0.15	0.25
Ød	1.52	1.63
ØD	3.00	3.23
ØD1	1.95	2.11
L	1.52	1.63

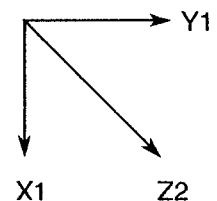
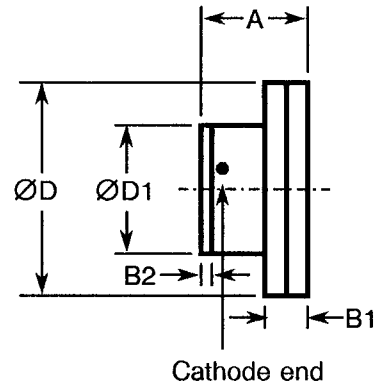
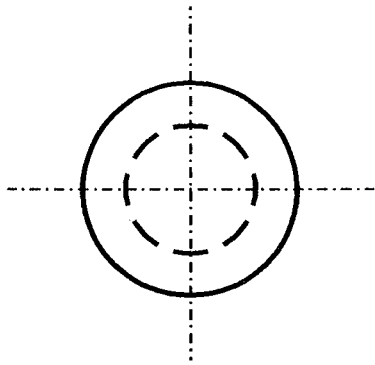



FIGURE 2 - PHYSICAL DIMENSIONS (CONTINUED)

FIGURE 2(e) - VARIANTS 05, 18, 31, 44, 57, 70



SYMBOL	MILLIMETRES	
	MIN	MAX
A	1.02	1.27
B1	-	0.38
B2	0.10	0.25
ØD	1.98	2.18
ØD1	1.19	1.35

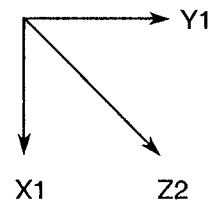
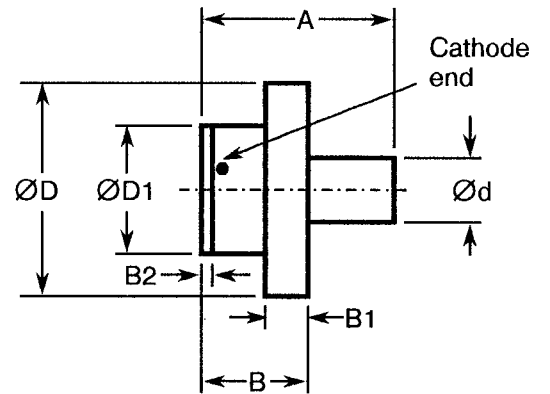
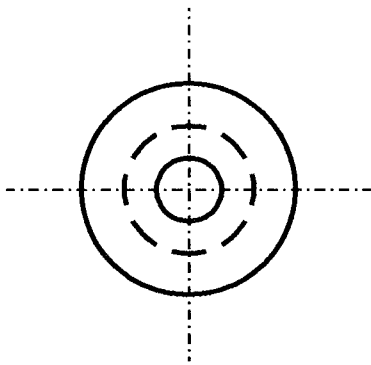

FIGURE 2(f) - VARIANTS 06, 19, 32, 45, 58, 71



SYMBOL	MILLIMETRES	
	MIN	MAX
A	1.78	2.03
B	1.02	1.27
B1	-	0.38
B2	0.10	0.25
Ød	0.61	0.66
ØD	1.98	2.18
ØD1	1.19	1.35

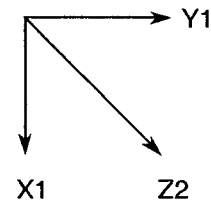
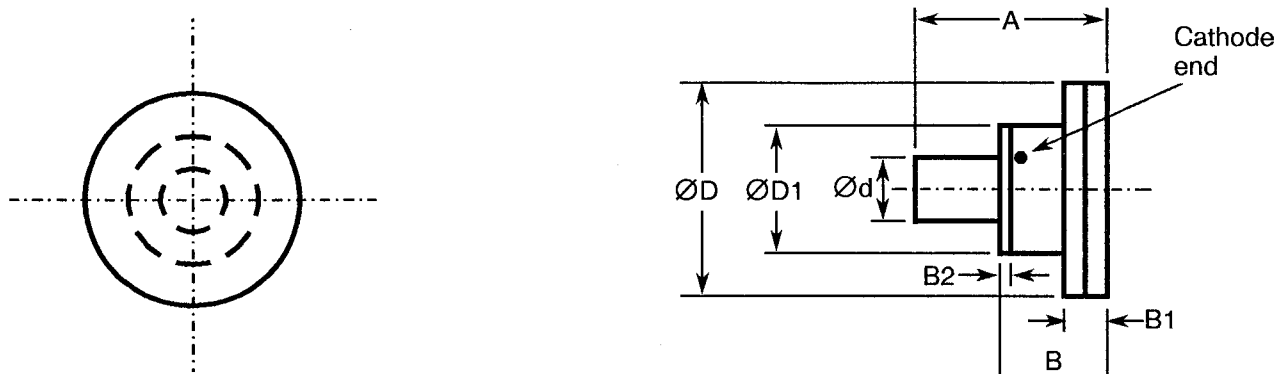

FIGURE 2 - PHYSICAL DIMENSIONS (CONTINUED)

FIGURE 2(g) - VARIANTS 07, 20, 33, 46, 59, 72



SYMBOL	MILLIMETRES	
	MIN	MAX
A	1.78	2.03
B	1.02	1.27
B1	-	0.38
B2	0.10	0.25
Ød	0.61	0.66
ØD	1.98	2.18
ØD1	1.19	1.35

FIGURE 2(h) - VARIANTS 08, 21, 34, 47, 60, 73

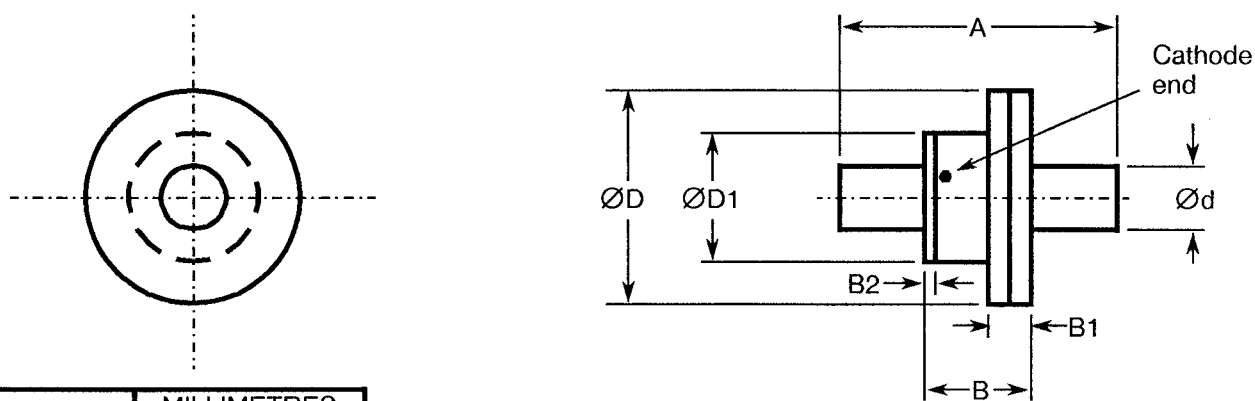

SYMBOL	MILLIMETRES	
	MIN	MAX
A	2.54	2.79
B	1.02	1.27
B1	-	0.38
B2	0.10	0.25
Ød	0.61	0.66
ØD	1.98	2.18
ØD1	1.19	1.35



FIGURE 2 - PHYSICAL DIMENSIONS (CONTINUED)

FIGURE 2(i) - VARIANTS 09, 22, 35, 48, 61, 74

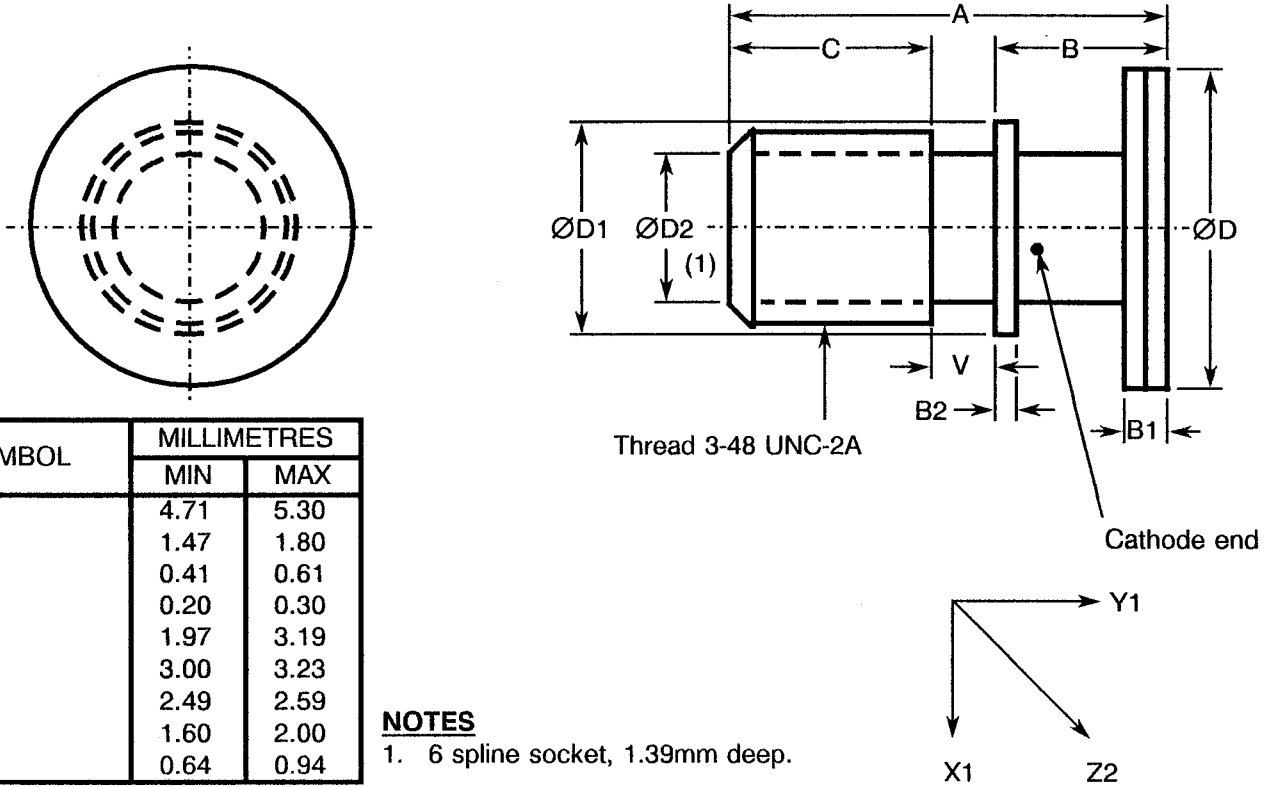

SYMBOL	MILLIMETRES	
	MIN	MAX
A	4.71	5.30
B	1.47	1.80
B1	0.41	0.61
B2	0.20	0.30
C	1.97	3.19
ØD	3.00	3.23
ØD1	2.49	2.59
ØD2	1.60	2.00
V	0.64	0.94

FIGURE 2(j) - VARIANTS 10, 23, 36, 49, 62, 75

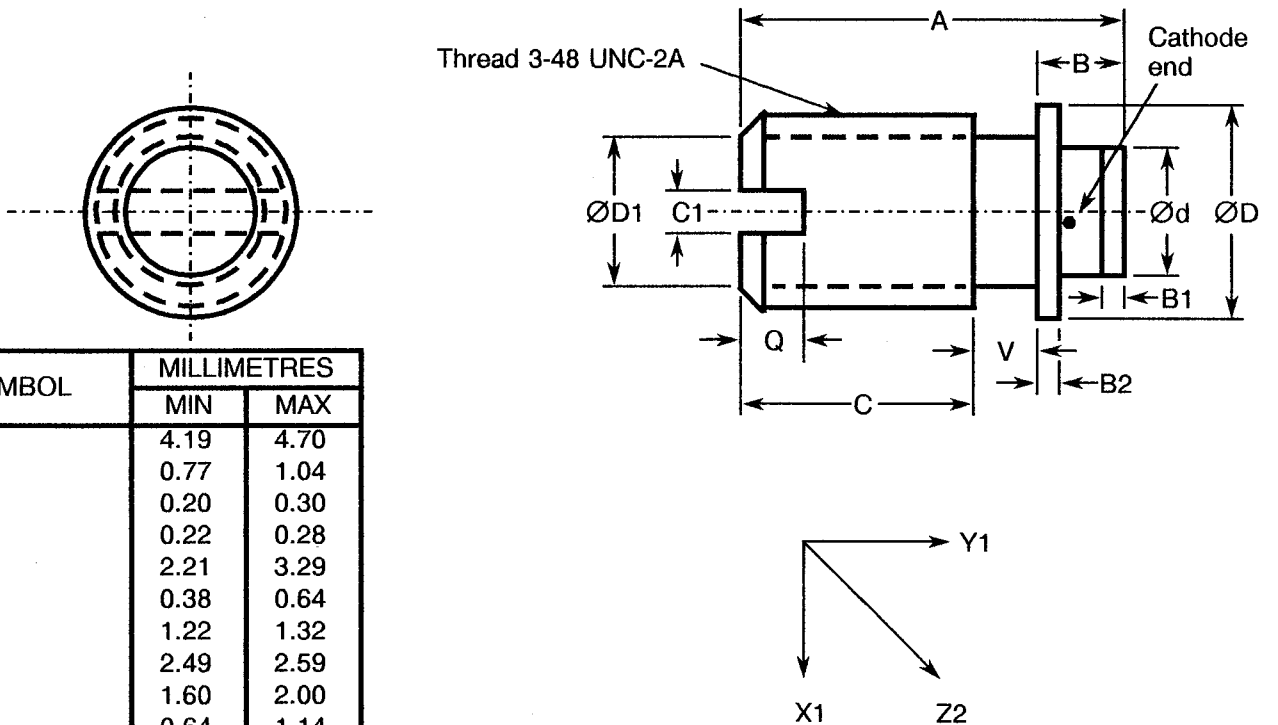

SYMBOL	MILLIMETRES	
	MIN	MAX
A	4.19	4.70
B	0.77	1.04
B1	0.20	0.30
B2	0.22	0.28
C	2.21	3.29
C1	0.38	0.64
Ød	1.22	1.32
ØD	2.49	2.59
ØD1	1.60	2.00
Q	0.64	1.14
V	0.64	0.94



FIGURE 2 - PHYSICAL DIMENSIONS (CONTINUED)

FIGURE 2(k) - VARIANTS 11, 24, 37, 50, 63, 76

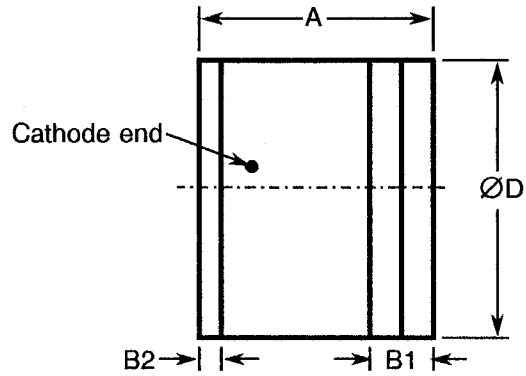
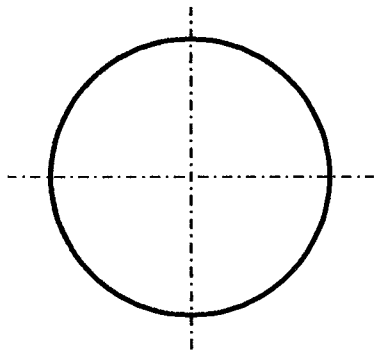

SYMBOL	MILLIMETRES	
	MIN	MAX
A	1.02	1.27
B1	0.23	0.33
B2	0.10	0.15
ØD	1.29	1.40

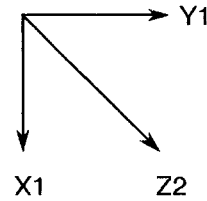
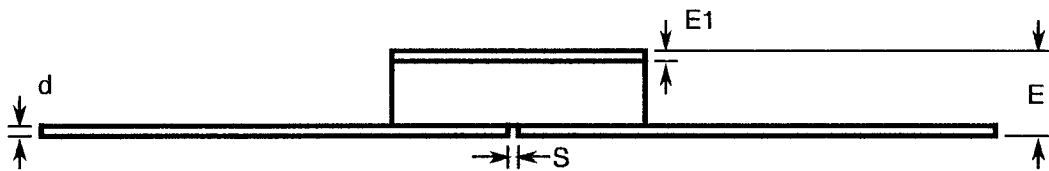
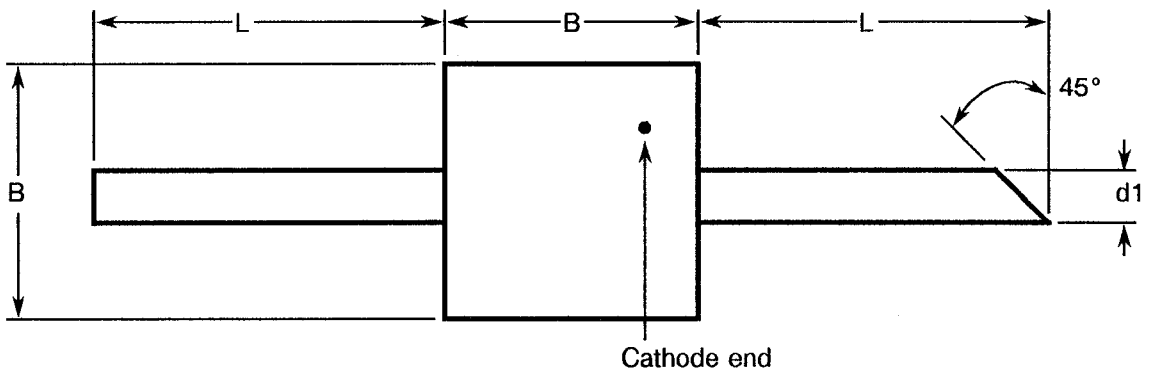

FIGURE 2(l) - VARIANTS 12, 25, 38, 51, 64, 77



SYMBOL	MILLIMETRES	
	MIN	MAX
B	2.39	2.62
d	0.07	0.15
d1	0.48	0.56
E	0.79	1.12
E1	0.10	0.18
L	3.30	5.84
S	0.10	-

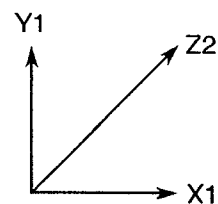
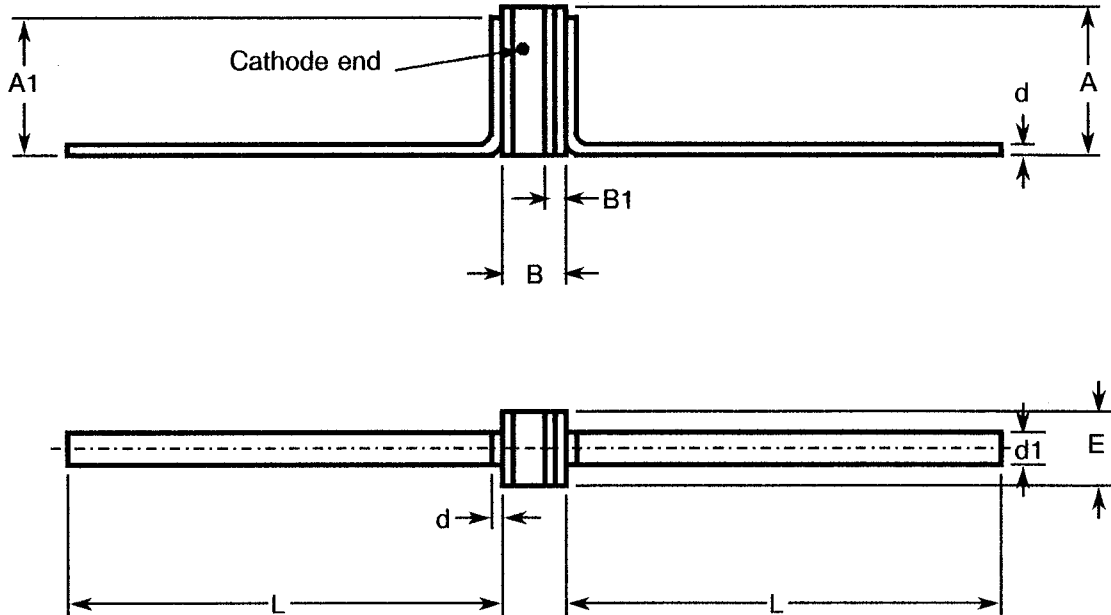



FIGURE 2 - PHYSICAL DIMENSIONS (CONTINUED)

FIGURE 2(m) - VARIANTS 13, 26, 39, 52, 65, 78



SYMBOL	MILLIMETRES	
	MIN	MAX
A	1.35	2.54
A1	-	2.46
B	1.02	1.27
B1	-	0.38
d	0.07	0.15
d1	0.38	0.64
E	1.29	1.40
L	6.10	12.40

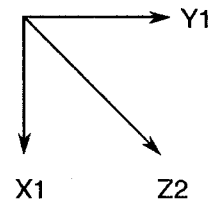
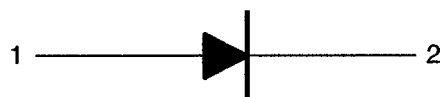



FIGURE 3 - FUNCTIONAL DIAGRAM



- 1. Anode
- 2. Cathode

NOTES

- 1. The cathode end shall be marked with a black dot or band. The marking will not be on the cathode connection but adjacent to it.

 SCC	ESA/SCC Detail Specification No. 5512/014		PAGE 17 ISSUE 1
--	--	--	--------------------

4. REQUIREMENTS

4.1 GENERAL

The complete requirements for procurement of the diodes specified herein shall be as stated in this specification and ESA/SCC Generic Specification No. 5010 for Discrete Microwave Semiconductor Components. Deviations from the Generic Specification applicable to this specification only, are listed in Para. 4.2.

Deviations from the applicable Generic Specification and this Detail Specification, formally agreed with specific Manufacturers on the basis that the alternative requirements are equivalent to the ESA/SCC requirements and do not affect the components' reliability, are listed in the appendices attached to this specification.

4.2 DEVIATIONS FROM GENERIC SPECIFICATION

4.2.1 Deviations from Special In-process Controls

- (a) Para. 5.2.2, Total Dose Irradiation Testing: Shall be performed during qualification and extension of qualification.
- (b) Para. 5.2.2, Total Dose Irradiation Testing: Shall be performed during procurement on a lot acceptance basis at the total dose irradiation level specified in the purchase order.
- (c) Para. 5.3, Wafer Lot Acceptance: Shall be performed as an S.E.M. Inspection only.
- (d) Quality Factor Measurement (Q): 3 randomly chosen samples shall be encapsulated in the type of package shown in Figure 2(a) of this specification. After encapsulation, Quality Factor measurements shall be performed using the method shown in Figure 4 of this specification with $V_R = -4.0V$. The limits specified in Table 1(a) of this specification shall be met.

4.2.2 Deviations from Final Production Tests (Chart II)

- (a) Para. 9.14, Vibration, Variable Frequency: Shall not be performed.

4.2.3 Deviations from Burn-in and Electrical Measurements (Chart III)

- (a) Para. 7.1.1(a), High Temperature Reverse Bias Burn-in: Shall be performed at 33% of rated V_R .

4.2.4 Deviations from Qualification Tests (Chart IV)

- (a) Para. 9.23, Special Testing: Shall not be performed.

4.2.5 Deviations from Lot Acceptance Tests (Chart V)

- (a) Para. 9.23, Special Testing: Shall not be performed.

4.3 MECHANICAL AND ENVIRONMENTAL REQUIREMENTS

4.3.1 Dimension Check

The dimensions of the diodes specified herein shall be checked. They shall conform to those shown in Figure 2.

4.3.2 Weight

The maximum weight of the diodes specified herein shall be:

Variant No.	Weight (g)
01, 14, 27, 40, 53, 66	0.12
02, 15, 28, 41, 54, 67	0.06
03, 16, 29, 42, 55, 68	0.01
04, 17, 30, 43, 56, 69	0.10
05, 18, 31, 44, 57, 70	0.013
06, 07, 19, 20, 32, 33, 45, 46, 58, 59, 71, 72	0.015

Variant No.	Weight (g)
08, 21, 34, 47, 60, 73	0.022
09, 10, 22, 23, 35, 36, 48, 49, 61, 62, 74, 75	0.14
11, 24, 37, 50, 63, 76	0.014
12, 25, 38, 51, 64, 77	0.06
13, 26, 39, 52, 65, 78	0.025

4.3.3 Terminal Strength

The requirements for terminal strength testing are specified in Section 9 of ESA/SCC Generic Specification No. 5010. The test conditions shall be as follows:-

(a) **Condition: 'A' (Tension)**

Variants 12, 25, 38, 51, 64 and 77:

- Force: 5.1N.
- Duration: 5 seconds.

Variants 13, 26, 39, 52, 65 and 78:

- Force: 1.22N.
- Duration: 5 seconds.

(b) **Condition: 'D2' (Stud Torque)**

Variants 09, 22, 35, 48, 61 and 74:

- Torque: 56mNm.
- Duration: 5 seconds.

Variants 10, 23, 36, 49, 62 and 75:

- Torque: 42mNm.
- Duration: 5 seconds.

(c) **Condition: Compression**

Variants 01, 02, 04, 09, 14, 15, 17, 21, 27, 28, 30, 35, 40, 41, 43, 48, 53, 54, 56, 61, 66, 67, 69 and 74:

- Force: 50N.
- Duration: 5 seconds.

Variants 03, 05, 06, 07, 08, 10, 11, 16, 18, 19, 20, 21, 23, 24, 29, 31, 32, 33, 34, 36, 37, 42, 44, 45, 46, 47, 49, 50, 55, 57, 58, 59, 60, 62, 63, 68, 70, 71, 72, 73, 75 and 76:

- Force: 10N.
- Duration: 5 seconds.

The compression test shall be performed by applying the specified force to the end-cap by means of a suitable weight applied for the specified time. On completion of the test, a visual examination shall be performed to check for damage to the end-cap or the ceramic body.

 SCC	ESA/SCC Detail Specification No. 5512/014		PAGE 19 ISSUE 1
--	--	--	--------------------

4.3.4 Bond Strength

The requirements for bond strength are as specified in Section 9 of ESA/SCC Generic Specification No. 5010. The test conditions shall be as follows:

- (a) Condition : 'A'.
- (b) Separating Force : 0.02N minimum.

4.3.5 Die Shear

The requirements for die shear are as specified in Section 9 of ESA/SCC Generic Specification No. 5010. The test conditions shall be as follows:

- (a) Force : 0.45N minimum.

4.4 MATERIALS AND FINISHES

The materials and finishes shall be as specified herein. Where a definite material is not specified, a material which will enable the diodes specified herein to meet the performance requirements of this specification shall be used. Acceptance or approval of any constituent material shall not guarantee acceptance of the finished product.

4.4.1 Case

The case shall be hermetically sealed and have a ceramic body. The lid shall be brazed, welded or preform soldered.

4.4.2 Lead Materials and Finish

- (a) For Variants 01, 02, 04, 05, 06, 07, 08, 09, 14, 15, 17, 18, 19, 20, 21, 22, 27, 28, 30, 31, 32, 33, 34, 35, 40, 41, 43, 44, 45, 46, 47, 48, 53, 54, 56, 57, 58, 59, 60, 61, 66, 67, 69, 70, 71, 72, 73 and 74, the body material shall be Type 'A' with Type '7' finish and the lid material shall be Type 'D' with Type '2' finish, in accordance with the requirements of ESA/SCC Basic Specification No. 23500.
- (b) For Variants 03, 10, 16, 23, 29, 36, 42, 49, 55, 62, 68 and 75, the lead material shall be Type 'A' with Type '7' finish in accordance with the requirements of ESA/SCC Basic Specification No. 23500.
- (c) For Variants 11, 12, 13, 24, 25, 26, 37, 38, 39, 50, 51, 52, 63, 64, 65, 76, 77 and 78, the lead material shall be Type 'D' with Type '2' finish in accordance with the requirements of ESA/SCC Basic Specification No. 23500.

4.5 MARKING

4.5.1 General

The marking of components delivered to this specification shall be in accordance with the requirements of ESA/SCC Basic Specification No. 21700 and the following paragraphs. When the component is too small to accommodate all of the marking specified, as much as space permits shall be marked and the marking information, in full, shall accompany the component in its primary package.

The information to be marked and the order of precedence, shall be as follows:-

- (a) Cathode Identification.
- (b) The SCC Component Number.
- (c) Traceability Information.

4.5.2 Cathode Identification

Cathode identification shall be as shown in Figures 2 and 3 of this specification.

4.5.3 The SCC Component Number

Each component shall bear the SCC Component Number which shall be constituted and marked as follows:

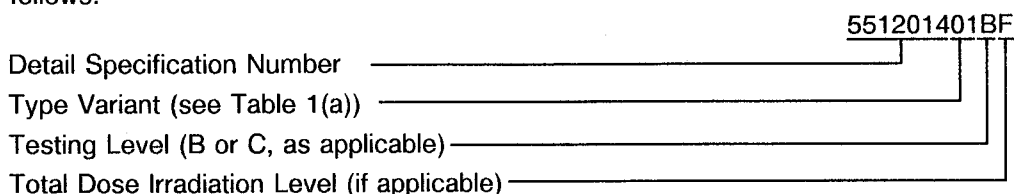

The Total Dose Irradiation Level designation shall be added for those devices for which a sample has been successfully tested to the level in question. For these devices, a code letter shall be added in accordance with the requirements of ESA/SCC Basic Specification No. 22900.

4.5.4 Traceability Information

Each component shall be marked in respect of traceability information as defined in ESA/SCC Basic Specification No. 21700.

4.6 ELECTRICAL MEASUREMENTS

4.6.1 Electrical Measurements at Room Temperature

The parameters to be measured at room temperature are scheduled in Table 2. Unless otherwise specified, the measurements shall be performed at $T_{amb} = +22 \pm 3$ °C.

4.6.2 Electrical Measurements at High and Low Temperatures

The parameters to be measured at high and low temperatures are scheduled in Table 3. Unless otherwise specified, the measurements shall be performed at $T_{amb} = +125(+0-3)$ °C.

4.6.3 Circuits for Electrical Measurements

A circuit for use in performing the quality factor measurement is shown in Figure 4.

4.7 BURN-IN TESTS

Burn-in shall be Category 1 of Chart III(a).

4.7.1 Parameter Drift Values

The parameter drift values applicable to burn-in are specified in Table 4 of this specification. Unless otherwise stated, the measurements shall be performed at $T_{amb} = +22 \pm 3$ °C. The parameter drift values (Δ) applicable to the scheduled parameters shall not be exceeded. In addition to these drift value requirements for a given parameter, the appropriate limit value specified in Table 2 shall not be exceeded.

4.7.2 Conditions for High Temperature Reverse Bias Burn-in

The requirements for the high temperature reverse bias burn-in are specified in Section 7 of ESA/SCC Generic Specification No. 5010. The conditions for high temperature reverse bias burn-in shall be as specified in Table 5(a) of this specification.

4.7.3 Electrical Circuit for High Temperature Reverse Bias Burn-in

The circuit for use in performing the H.T.R.B burn-in test is shown in Figure 5 of this specification.

**TABLE 2 - ELECTRICAL MEASUREMENTS AT ROOM TEMPERATURE - D.C. PARAMETERS**

No.	CHARACTERISTICS	SYMBOL	MIL-STD-750 TEST METHOD	TEST CONDITIONS	LIMITS		UNIT
					MIN.	MAX.	
1	Reverse Current 1	I_{R1}	4016	Variants 01 to 26: $V_R = -30V$ Variants 27 to 52: $V_R = -45V$ Variants 53 to 78: $V_R = -60V$	-	10	μA
2	Reverse Current 2	I_{R2}	4016	Variants 01 to 26: $V_R = -20V$ Variants 27 to 52: $V_R = -30V$ Variants 53 to 78: $V_R = -40V$	-	100	nA
3	Forward Voltage	V_F	4011	$I_F = 10\mu A$	-	1.1	V

TABLE 2 - ELECTRICAL MEASUREMENTS AT ROOM TEMPERATURE - A.C. PARAMETERS

No.	CHARACTERISTICS	SYMBOL	MIL-STD-750 TEST METHOD	TEST CONDITIONS	LIMITS		UNIT
					MIN.	MAX.	
4	Total Capacitance	C_T	4001	$V_R = -4.0V$ $f = 1.0MHz$	Note 1		pF
5	Total Capacitance Ratio	-	4001	$V_R = 0V$ $V_R = \text{Note 2}$ $f = 1.0MHz$ Note 3 Variants 01 to 13 Variants 14 to 26 Variants 27 to 39 Variants 40 to 52 Variants 53 to 65 Variants 66 to 78	3.7 3.8 4.7 4.8 5.1 5.3	- - - - - -	

NOTES

1. See Column 4 of Table 1(a).

2. See Table 1(b), Item 1.

3. Ratio = $\frac{C_T \text{ at } V_R = 0V}{C_T \text{ at } V_R = \text{Note 2}}$

**TABLE 3 - ELECTRICAL MEASUREMENTS AT HIGH AND LOW TEMPERATURES**

No.	CHARACTERISTICS	SYMBOL	MIL-STD-750 TEST METHOD	TEST CONDITIONS	LIMITS		UNIT
					MIN.	MAX.	
6	Reverse Current 3	I_{R3}	4016	Variants 01 to 26: $V_R = -10V$ Variants 27 to 52: $V_R = -15V$ Variants 53 to 78: $V_R = -20V$	-	10	μA

TABLE 4 - PARAMETER DRIFT VALUES

No.	CHARACTERISTICS	SYMBOL	SPEC.AND/OR TEST METHOD	TEST CONDITIONS	CHANGE LIMITS (Δ)	UNIT
2	Reverse Current 2	I_{R2}	As per Table 2	As per Table 2	± 10 (1) or (2) ± 100 (1)	nA %
3	Forward Voltage	V_F	As per Table 2	As per Table 2	± 100 (1)	mV

NOTES

1. $\Delta 1 = \Delta 2$.
2. Whichever is the greater, referred to the initial measurement.

FIGURE 4 - CIRCUITS FOR ELECTRICAL MEASUREMENTS

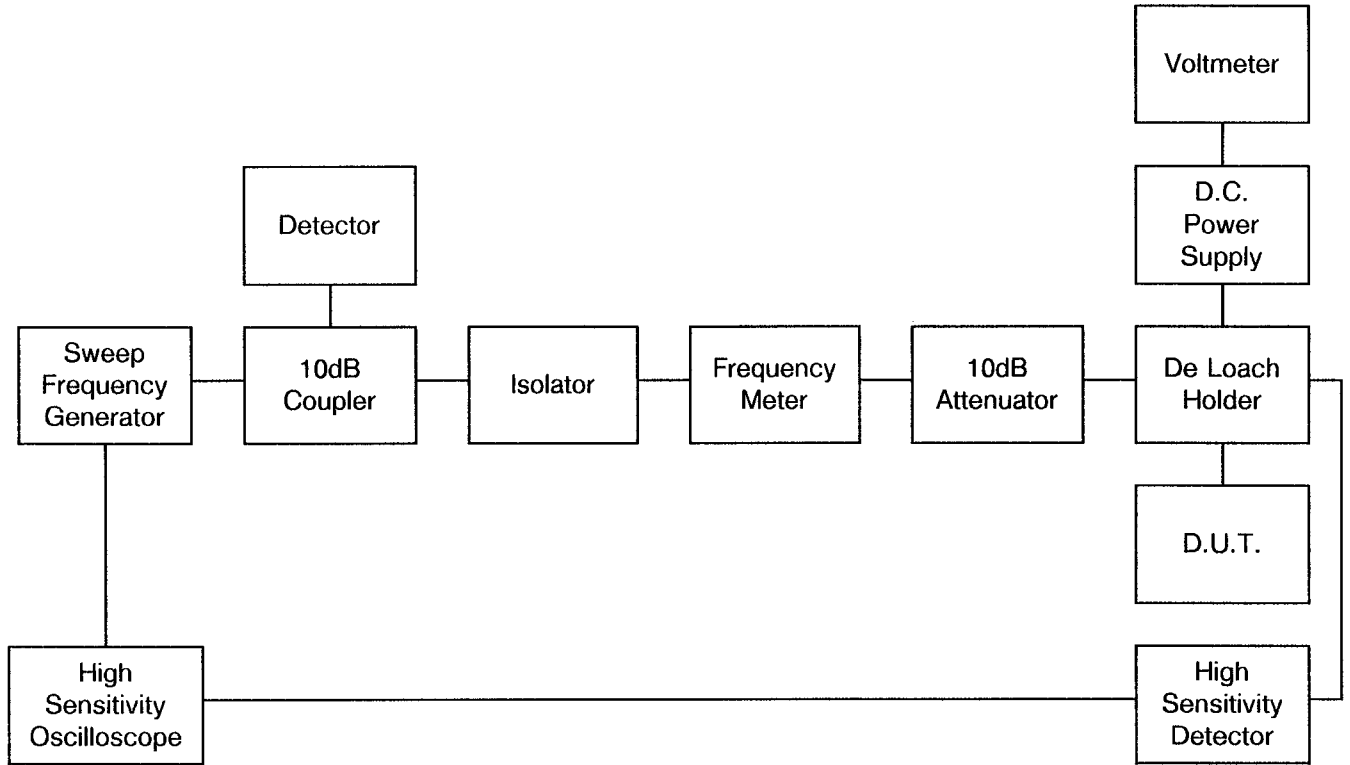

TABLE 5(a) - CONDITIONS FOR HIGH TEMPERATURE REVERSE BIAS BURN-IN



No.	CHARACTERISTICS	SYMBOL	CONDITIONS	UNIT
1	Ambient Temperature	T_{amb}	+ 125(+ 0 - 3)	°C
2	Reverse Voltage	V_R	Variants 01 to 26: - 10 Variants 27 to 52: - 15 Variants 53 to 78: - 20	V

TABLE 5(b) - CONDITIONS FOR OPERATING LIFE TESTS

No.	CHARACTERISTICS	SYMBOL	CONDITIONS	UNIT
1	Ambient Temperature 1	T_{amb1}	+ 115(+ 0 - 3)	°C
2	Reverse Voltage 1	V_{R1}	Variants 01 to 26: - 10 Variants 27 to 52: - 15 Variants 53 to 78: - 20	V
3	Ambient Temperature 2	T_{amb2}	+ 125(+ 0 - 3)	°C
4	Reverse Voltage 2	V_{R2}	Variants 01 to 26: - 10 Variants 27 to 52: - 15 Variants 53 to 78: - 20	V

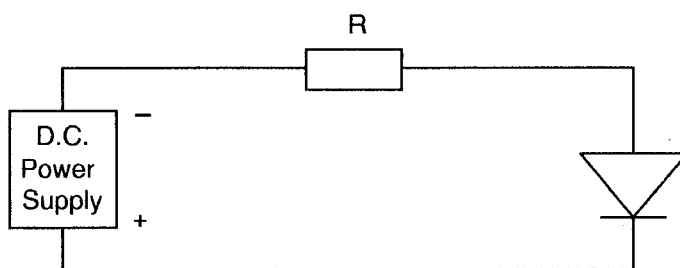
FIGURE 5 - ELECTRICAL CIRCUIT FOR HIGH TEMPERATURE REVERSE BIAS BURN-IN AND OPERATING LIFE TESTS



 	<p style="text-align: center;">ESA/SCC Detail Specification No. 5512/014</p>		<p>PAGE 25 ISSUE 1</p>
---	--	--	----------------------------

4.8 ENVIRONMENTAL AND ENDURANCE TESTS (CHARTS IV AND V OF ESA/SCC GENERIC SPECIFICATION NO. 5010)

4.8.1 Electrical Measurements on Completion of Environmental Tests

The parameters to be measured on completion of environmental tests are scheduled in Table 2. Unless otherwise stated, the measurements shall be performed at $T_{amb} = +22 \pm 3$ °C.

4.8.2 Electrical Measurements at Intermediate Points and on Completion of Endurance Tests

The parameters to be measured at intermediate points and on completion of endurance tests are scheduled in Table 6. Unless otherwise stated, the measurements shall be performed at $T_{amb} = +22 \pm 3$ °C.

4.8.3 Conditions for Operating Life Tests (Part of Endurance Testing)

The requirements for operating life testing are specified in Section 9 of ESA/SCC Generic Specification No. 5010. The conditions for operating life testing are specified in Table 5(b) of this specification.

4.8.4 Electrical Circuits for Operating Life Tests

The circuit to be used for performance of the operating life test shall be the same as shown in Figure 5 for High Temperature Reverse Bias Burn-in.

4.9 TOTAL DOSE IRRADIATION TESTING

4.9.1 Application

If specified in Para. 4.2.1 of this specification, total dose irradiation testing shall be performed in accordance with the requirements of ESA/SCC Basic Specification No. 22900.

4.9.2 Bias Conditions

Continuous bias shall be applied during irradiation testing as shown in Figure 6 of this specification.

4.9.3 Electrical Measurements

The parameters to be measured prior to irradiation exposure are scheduled in Table 2 of this specification. Only devices which meet the requirements of Table 2 shall be included in the test sample.

The parameters to be measured during and on completion of irradiation testing are scheduled in Table 7 of this specification.

4.10 SPECIAL TESTING

Not applicable.

TABLE 6 - ELECTRICAL MEASUREMENTS AT INTERMEDIATE POINTS AND ON COMPLETION OF ENDURANCE TESTING

No.	CHARACTERISTICS	SYMBOL	SPEC. AND/OR TEST METHOD	TEST CONDITIONS	LIMITS		UNIT
					MIN.	MAX.	
1	Reverse Current 1	I_{R1}	As per Table 2	As per Table 2	As per Table 2		μA
2	Reverse Current 2	I_{R2}	As per Table 2	As per Table 2	As per Table 2		nA
3	Forward Voltage	V_F	As per Table 2	As per Table 2	As per Table 2		V
4	Total Capacitance	C_T	As per Table 2	As per Table 2	As per Table 2		pF

FIGURE 6 - BIAS CONDITIONS FOR IRRADIATION TESTING

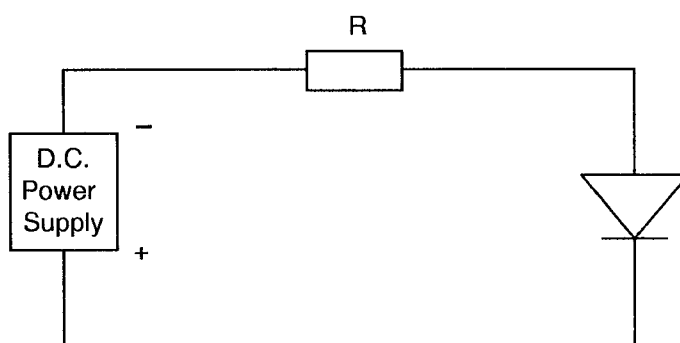

NOTES

1. A reverse bias of $V_R = -10V$ (Variants 01 to 26), $-15V$ (Variants 27 to 52) or $-20V$ (Variants 53 to 78), shall be applied.

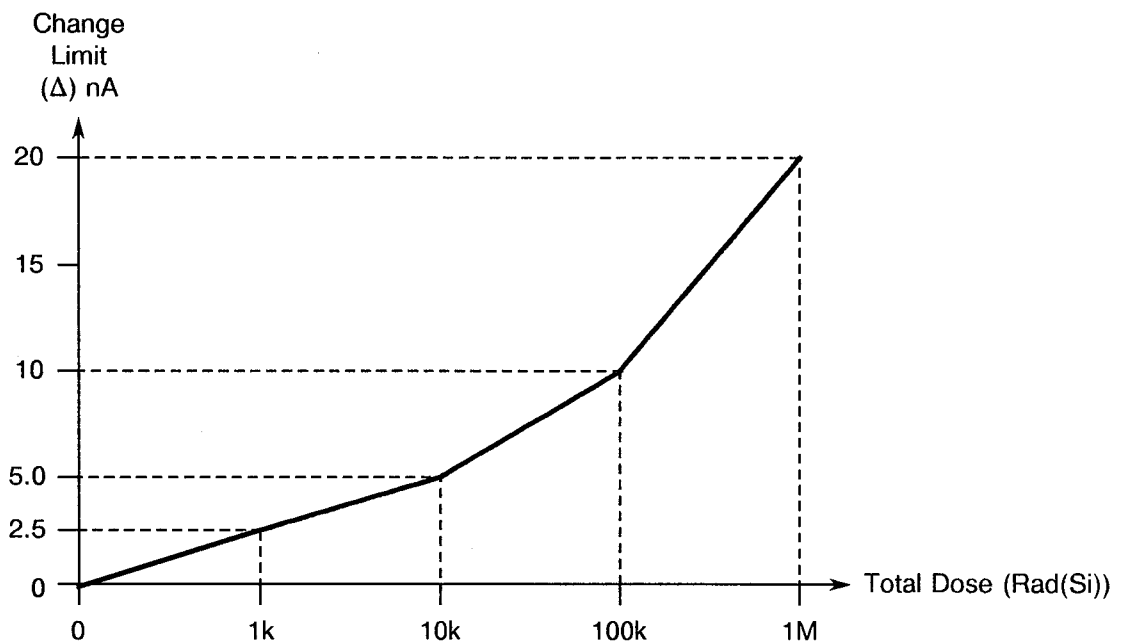



TABLE 7 - ELECTRICAL MEASUREMENTS DURING AND ON COMPLETION OF IRRADIATION TESTING

No.	CHARACTERISTICS	SYMBOL	SPEC. AND/OR TEST METHOD	TEST CONDITIONS	CHANGE LIMITS (Δ)	UNIT
2	Reverse Current 2	I_{R2}	As per Table 2	As per Table 2	Note 1	nA

NOTES

1. The graph given below shall be used to determine the maximum permitted change.



	<p>ESA/SCC Detail Specification No. 5512/014</p>		<p>PAGE 28 ISSUE 1</p>
---	--	--	----------------------------

APPENDIX 'A'

Page 1 of 1

AGREED DEVIATIONS FOR M/A-Com LTD. (G.B.)

ITEMS AFFECTED	DESCRIPTION OF DEVIATIONS
Para. 4.2.2	Para. 9.4, "High Temperature Stabilisation Bake": May be performed at +125(+0-3) °C.