



**DIODES, MICROWAVE, GALLIUM ARSENIDE,  
HYPERABRUPT TUNING VARACTOR,  
BASED ON TYPES ML4572 THRU ML4576  
ESCC Detail Specification No. 5512/013**

**ISSUE 1  
October 2002**



	ESCC Detail Specification		PAGE ii ISSUE 1
--	---------------------------	--	--------------------

### **LEGAL DISCLAIMER AND COPYRIGHT**

European Space Agency, Copyright © 2002. All rights reserved.

The European Space Agency disclaims any liability or responsibility, to any person or entity, with respect to any loss or damage caused, or alleged to be caused, directly or indirectly by the use and application of this ESCC publication.

This publication, without the prior permission of the European Space Agency and provided that it is not used for a commercial purpose, may be:

- copied in whole in any medium without alteration or modification.
- copied in part, in any medium, provided that the ESCC document identification, comprising the ESCC symbol, document number and document issue, is removed.



europaean space agency  
agence spatiale européenne


Pages 1 to 27

**DIODES, MICROWAVE, GALLIUM ARSENIDE,  
HYPERABRUPT TUNING VARACTOR,  
BASED ON TYPES ML4572 THRU ML4576  
ESA/SCC Detail Specification No. 5512/013**



**space components  
coordination group**

Issue/Rev.	Date	Approved by	
		SCCG Chairman	ESA Director General or his Deputy
Issue 1	April 1993	<i>Pommes</i>	<i>J. Loh</i>
Revision 'A'	February 1994	<i>Pommes</i>	<i>J. Loh</i>



	<p>ESA/SCC Detail Specification No. 5512/013</p>	<p>Rev. 'A'</p>	<p>PAGE 2 ISSUE 1</p>
---	--	-----------------	---------------------------

**DOCUMENTATION CHANGE NOTICE**

Rev. Letter	Rev. Date	Reference	CHANGE Item	Approved DCR No.
'A'	Feb.94	P1. Cover Page P2. DCN P21. Table 3 : Table amended		None None 221056

**TABLE OF CONTENTS**

		<u>Page</u>
<b>1.</b>	<b><u>GENERAL</u></b>	<b>5</b>
1.1	Scope	5
1.2	Type Variants	5
1.3	Maximum Ratings	5
1.4	Parameter Derating Information	5
1.5	Physical Dimensions	5
1.6	Functional Diagram	5
1.7	Handling Precautions	5
<b>2.</b>	<b><u>APPLICABLE DOCUMENTS</u></b>	<b>5</b>
<b>3.</b>	<b><u>TERMS, DEFINITIONS, ABBREVIATIONS, SYMBOLS AND UNITS</u></b>	<b>5</b>
<b>4.</b>	<b><u>REQUIREMENTS</u></b>	<b>16</b>
4.1	General	16
4.2	Deviations from Generic Specification	16
4.2.1	Deviations from Special In-process Controls	16
4.2.2	Deviations from Final Production Tests	16
4.2.3	Deviations from Burn-in and Electrical Measurements	16
4.2.4	Deviations from Qualification Tests	16
4.2.5	Deviations from Lot Acceptance Tests	16
4.3	Mechanical and Environmental Requirements	16
4.3.1	Dimension Check	16
4.3.2	Weight	17
4.3.3	Terminal Strength	17
4.3.4	Bond Strength	18
4.3.5	Die Shear	18
4.4	Materials and Finishes	18
4.4.1	Case	18
4.4.2	Lead Materials and Finish	18
4.5	Marking	18
4.5.1	General	18
4.5.2	Cathode Identification	19
4.5.3	The SCC Component Number	19
4.5.4	Traceability Information	19
4.6	Electrical Measurements	19
4.6.1	Electrical Measurements at Room Temperature	19
4.6.2	Electrical Measurements at High and Low Temperatures	19
4.6.3	Circuits for Electrical Measurements	19
4.7	Burn-in Tests	19
4.7.1	Parameter Drift Values	19
4.7.2	Conditions for High Temperature Reverse Bias Burn-in	19
4.7.3	Electrical Circuit for High Temperature Reverse Bias Burn-in	19
4.8	Environmental and Endurance Tests	24
4.8.1	Electrical Measurements on Completion of Environmental Tests	24
4.8.2	Electrical Measurements at Intermediate Points and on Completion of Endurance Tests	24
4.8.3	Conditions for Operating Life Tests	24
4.8.4	Electrical Circuits for Operating Life Tests	24
4.9	Total Dose Irradiation Testing	24
4.9.1	Application	24
4.9.2	Bias Conditions	24
4.9.3	Electrical Measurements	24
4.10	Special Testing	24

		<p style="text-align: center;">ESA/SCC Detail Specification No. 5512/013</p>	<p>PAGE 4 ISSUE 1</p>
--	--	--	---------------------------

**TABLES**



		<u>Page</u>
1(a)	Type Variants	6
1(b)	Maximum Ratings	8
2	Electrical Measurements at Room Temperature - D.C. Parameters	20
	Electrical Measurements at Room Temperature - A.C. Parameters	20
3	Electrical Measurements at High and Low Temperatures	21
4	Parameter Drift Values	21
5(a)	Conditions for High Temperature Reverse Bias Burn-in	23
5(b)	Conditions for Operating Life Tests	23
6	Electrical Measurements at Intermediate Points and on Completion of Endurance Testing	25
7	Electrical Measurements During and on Completion of Irradiation Testing	26

**FIGURES**

1	Parameter Derating Information	8
2	Physical Dimensions	9
3	Functional Diagram	15
4	Circuits for Electrical Measurements	22
5	Electrical Circuit for High Temperature Reverse Bias Burn-in and Operating Life Tests	23
6	Bias Conditions for Irradiation Testing	25

**APPENDICES (Applicable to specific Manufacturers only)**

'A'	Agreed Deviations for M/A-Com Ltd. (G.B.)	27
-----	---	----

 	<p style="text-align: center;">ESA/SCC Detail Specification No. 5512/013</p>		<p>PAGE 5 ISSUE 1</p>
--	--	--	---------------------------

**1. GENERAL**

**1.1 SCOPE**

This specification details the ratings, physical and electrical characteristics, test and inspection data for a Diode, Microwave, Gallium Arsenide, Hyperabrupt Tuning Varactor, based on Types ML4572 thru ML4576. It shall be read in conjunction with ESA/SCC Generic Specification No. 5010, the requirements of which are supplemented herein.

**1.2 TYPE VARIANTS**

Variants of the basic diodes specified herein, which are also covered by this specification are given in Table 1(a).

**1.3 MAXIMUM RATINGS**

The maximum ratings, which shall not be exceeded at any time during use or storage, applicable to the diodes specified herein, are as scheduled in Table 1(b).

**1.4 PARAMETER DERATING INFORMATION**

The derating information applicable to the diodes specified herein is shown in Figure 1.

**1.5 PHYSICAL DIMENSIONS**

The physical dimensions of the diodes specified herein are shown in Figure 2.

**1.6 FUNCTIONAL DIAGRAM**

The functional diagram, showing lead identification, of the diodes specified herein, is shown in Figure 3.

**1.7 HANDLING PRECAUTIONS**

These devices are susceptible to damage by electrostatic discharge. Therefore, suitable precautions shall be employed for protection during all phases of manufacture, testing, packaging, shipment and any handling.

These components are Categorised as Class 2 with a Minimum Critical Path Failure Voltage of 3000V.

**2. APPLICABLE DOCUMENTS**

The following documents form part of this specification and shall be read in conjunction with it:-

- (a) ESA/SCC Generic Specification No. 5010 for Discrete Microwave Semiconductor Components.
- (b) MIL-STD-750, Test Methods and Procedures for Semiconductor Devices.

**3. TERMS, DEFINITIONS, ABBREVIATIONS, SYMBOLS AND UNITS**

For the purpose of this specification, the terms, definitions, abbreviations, symbols and units specified in ESA/SCC Basic Specification No. 21300 shall apply.



**TABLE 1(a) - TYPE VARIANTS**

(1) VARIANT	(2) BASED ON TYPE	(3) FIGURE	(4) TOTAL CAPACITANCE $C_T$ (pF)		(5) QUALITY FACTOR (Q) (MINIMUM)	(6) BODY-LID AND LEAD MATERIAL AND FINISH
			MIN	MAX		
01	ML4572 - 30	2(a)	0.40	0.74	4000	A7-D2
02	ML4572 - 31	2(b)	0.40	0.74	4000	A7-D2
03	ML4572 - 33	2(c)	0.40	0.74	4000	A7
04	ML4572 - 36	2(d)	0.40	0.74	4000	A7-D2
05	ML4572 - 94	2(e)	0.40	0.74	4000	A7-D2
06	ML4572 - 95	2(f)	0.40	0.74	4000	A7-D2
07	ML4572 - 96	2(g)	0.40	0.74	4000	A7-D2
08	ML4572 - 97	2(h)	0.40	0.74	4000	A7-D2
09	ML4572 - 103	2(i)	0.40	0.74	4000	A7-D2
10	ML4572 - 118	2(j)	0.40	0.74	4000	A7
11	ML4572 - 120	2(k)	0.40	0.74	4000	D2
12	ML4572 - 186	2(l)	0.40	0.74	4000	D2
13	ML4572 - 276	2(m)	0.40	0.74	4000	D2
14	ML4573 - 30	2(a)	0.75	0.99	3500	A7-D2
15	ML4573 - 31	2(b)	0.75	0.99	3500	A7-D2
16	ML4573 - 33	2(c)	0.75	0.99	3500	A7
17	ML4573 - 36	2(d)	0.75	0.99	3500	A7-D2
18	ML4573 - 94	2(e)	0.75	0.99	3500	A7-D2
19	ML4573 - 95	2(f)	0.75	0.99	3500	A7-D2
20	ML4573 - 96	2(g)	0.75	0.99	3500	A7-D2
21	ML4573 - 97	2(h)	0.75	0.99	3500	A7-D2
22	ML4573 - 103	2(i)	0.75	0.99	3500	A7-D2
23	ML4573 - 118	2(j)	0.75	0.99	3500	A7
24	ML4573 - 120	2(k)	0.75	0.99	3500	D2
25	ML4573 - 186	2(l)	0.75	0.99	3500	D2
26	ML4573 - 276	2(m)	0.75	0.99	3500	D2
27	ML4574 - 30	2(a)	1.00	1.49	3000	A7-D2
28	ML4574 - 31	2(b)	1.00	1.49	3000	A7-D2
29	ML4574 - 33	2(c)	1.00	1.49	3000	A7
30	ML4574 - 36	2(d)	1.00	1.49	3000	A7-D2
31	ML4574 - 94	2(e)	1.00	1.49	3000	A7-D2
32	ML4574 - 95	2(f)	1.00	1.49	3000	A7-D2
33	ML4574 - 96	2(g)	1.00	1.49	3000	A7-D2
34	ML4574 - 97	2(h)	1.00	1.49	3000	A7-D2
35	ML4574 - 103	2(i)	1.00	1.49	3000	A7-D2
36	ML4574 - 118	2(j)	1.00	1.49	3000	A7





**TABLE 1(a) - TYPE VARIANTS (CONT'D)**

(1) VARIANT	(2) BASED ON TYPE	(3) FIGURE	(4) TOTAL CAPACITANCE $C_T$ (pF)		(5) QUALITY FACTOR (Q) (MINIMUM)	(6) BODY-LID AND LEAD MATERIAL AND FINISH
			MIN	MAX		
37	ML4574 - 120	2(k)	1.00	1.49	3000	D2
38	ML4574 - 186	2(l)	1.00	1.49	3000	D2
39	ML4574 - 276	2(m)	1.00	1.49	3000	D2
40	ML4575 - 30	2(a)	1.50	1.99	3000	A7-D2
41	ML4575 - 31	2(b)	1.50	1.99	3000	A7-D2
42	ML4575 - 33	2(c)	1.50	1.99	3000	A7
43	ML4575 - 36	2(d)	1.50	1.99	3000	A7-D2
44	ML4575 - 94	2(e)	1.50	1.99	3000	A7-D2
45	ML4575 - 95	2(f)	1.50	1.99	3000	A7-D2
46	ML4575 - 96	2(g)	1.50	1.99	3000	A7-D2
47	ML4575 - 97	2(h)	1.50	1.99	3000	A7-D2
48	ML4575 - 103	2(i)	1.50	1.99	3000	A7-D2
49	ML4575 - 118	2(j)	1.50	1.99	3000	A7
50	ML4575 - 120	2(k)	1.50	1.99	3000	D2
51	ML4575 - 186	2(l)	1.50	1.99	3000	D2
52	ML4575 - 276	2(m)	1.50	1.99	3000	D2
53	ML4576 - 30	2(a)	2.00	2.49	2500	A7-D2
54	ML4576 - 31	2(b)	2.00	2.49	2500	A7-D2
55	ML4576 - 33	2(c)	2.00	2.49	2500	A7
56	ML4576 - 36	2(d)	2.00	2.49	2500	A7-D2
57	ML4576 - 94	2(e)	2.00	2.49	2500	A7-D2
58	ML4576 - 95	2(f)	2.00	2.49	2500	A7-D2
59	ML4576 - 96	2(g)	2.00	2.49	2500	A7-D2
60	ML4576 - 97	2(h)	2.00	2.49	2500	A7-D2
61	ML4576 - 103	2(i)	2.00	2.49	2500	A7-D2
62	ML4576 - 118	2(j)	2.00	2.49	2500	A7
63	ML4576 - 120	2(k)	2.00	2.49	2500	D2
64	ML4576 - 186	2(l)	2.00	2.49	2500	D2
65	ML4576 - 276	2(m)	2.00	2.49	2500	D2

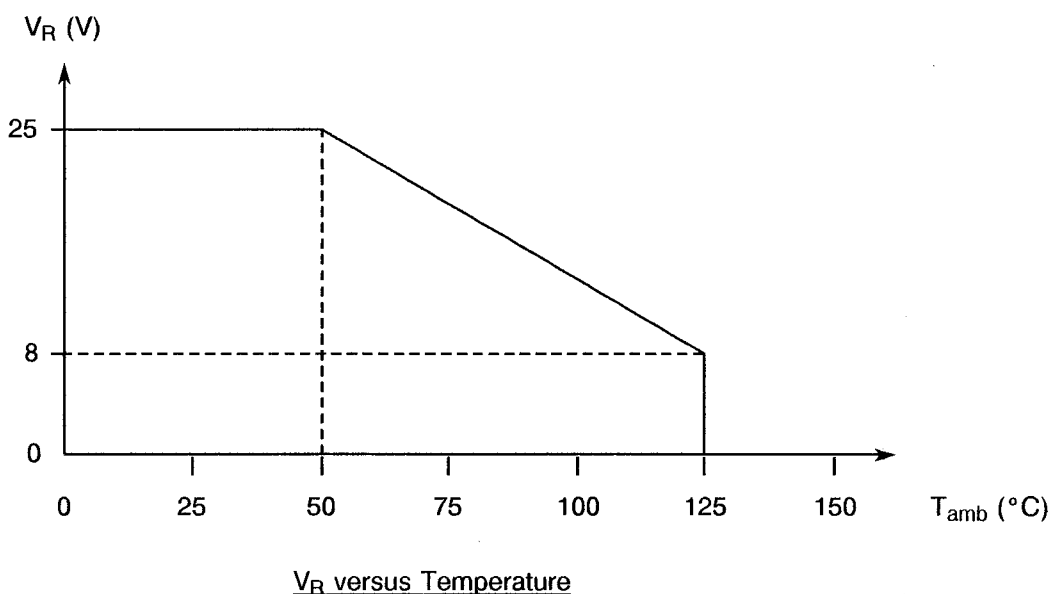
**TABLE 1(b) - MAXIMUM RATINGS**

No.	CHARACTERISTIC	SYMBOL	MAXIMUM RATINGS	UNIT	REMARKS
1	D.C. Reverse Voltage	$V_R$	- 25	V	Note 1
2	Operating Temperature Range	$T_{op}$	- 40 to + 125	°C	$T_{amb}$
3	Storage Temperature Range	$T_{stg}$	- 55 to + 125	°C	
4	Soldering Temperature	$T_{sol}$	+ 230	°C	Note 2

**NOTES**

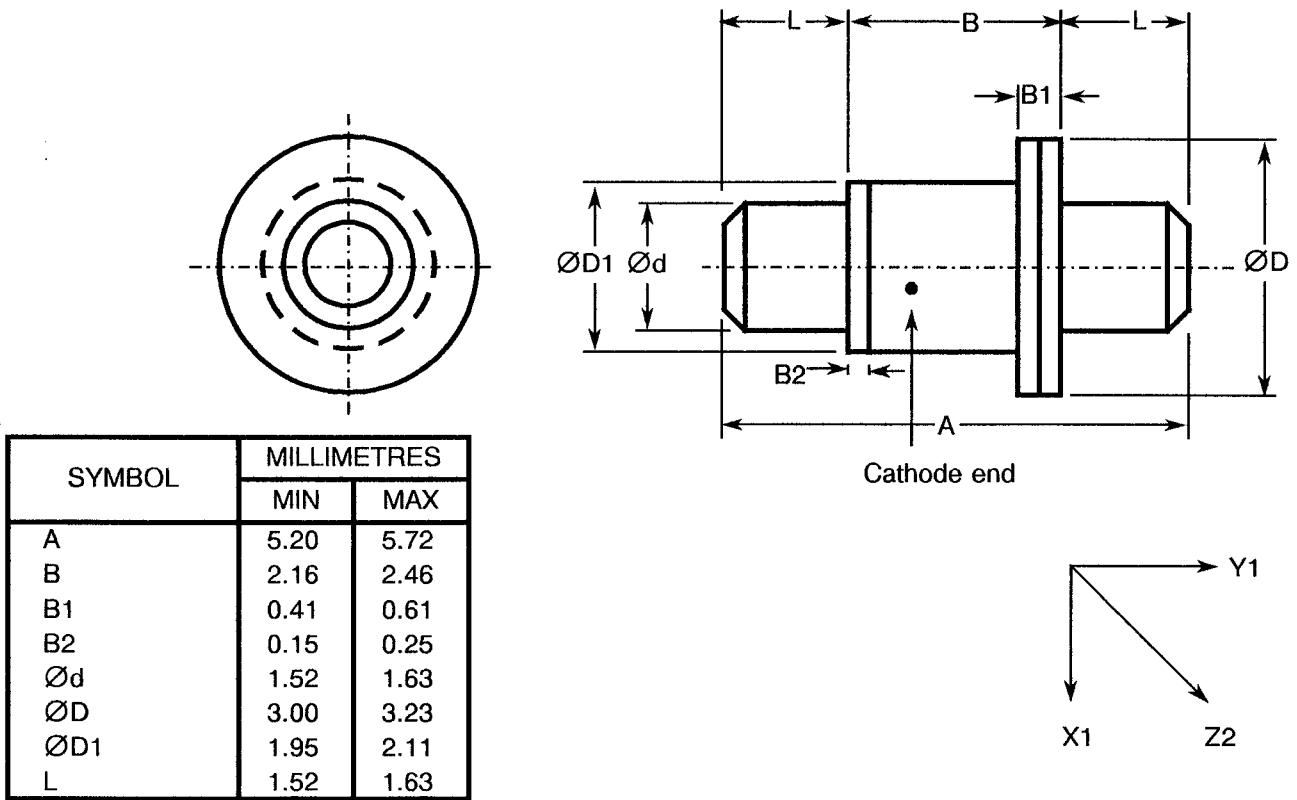
1. Measured at  $I_R = 10\mu A$  and  $T_{amb} = +50^\circ C$ . For derating at  $T_{amb} > +50^\circ C$ , see Figure 1.
2. Duration 5 seconds maximum (at a distance of not less than 1.5mm from the body for Variants 12, 13, 25, 26, 38, 39, 51, 52, 64 and 65) and the same termination shall not be resoldered until 3 minutes have elapsed.

**FIGURE 1 - PARAMETER DERATING INFORMATION**

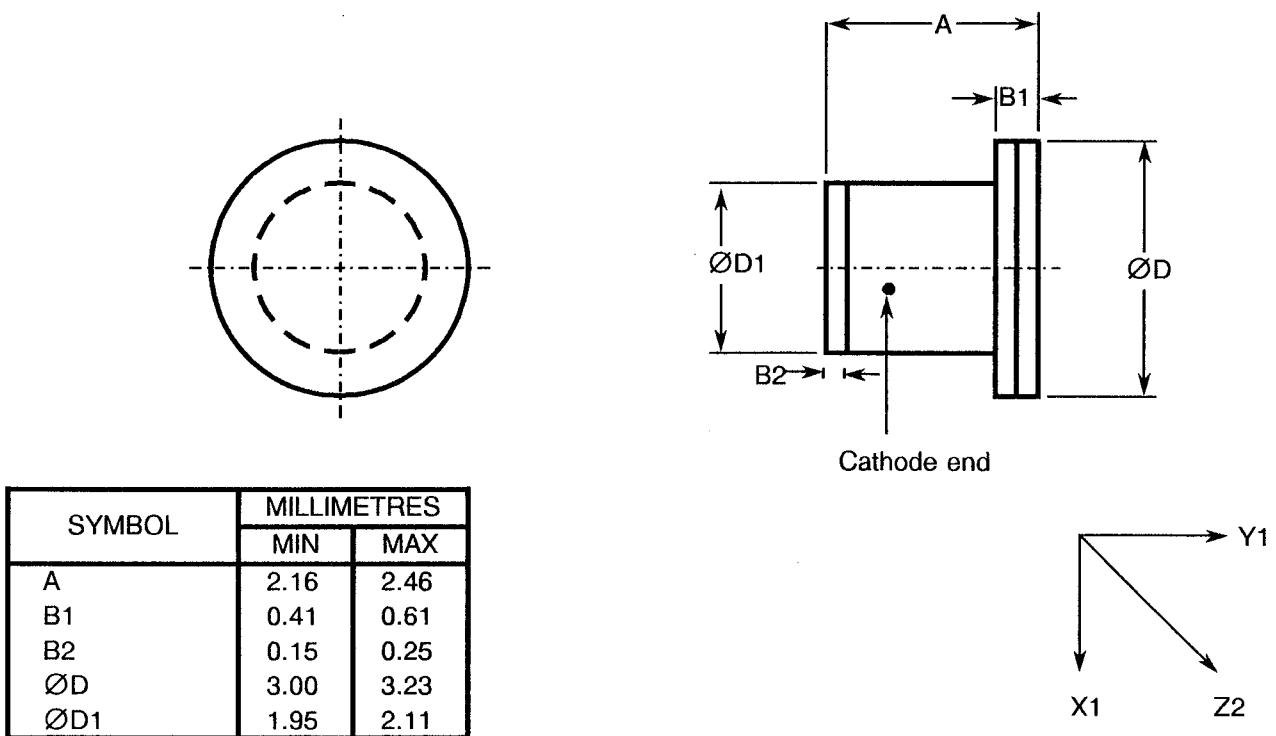


**FIGURE 2 - PHYSICAL DIMENSIONS**

**FIGURE 2(a) - VARIANTS 01, 14, 27, 40, 53**



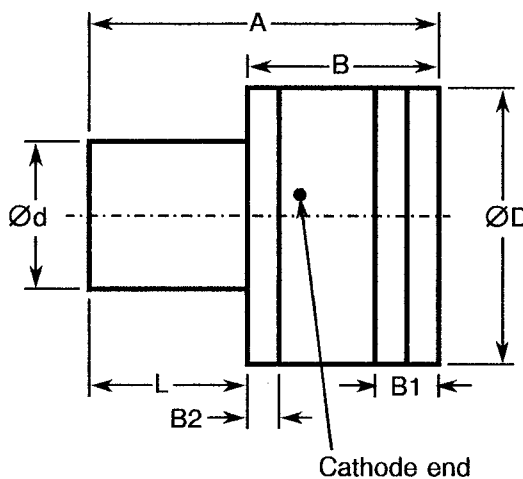
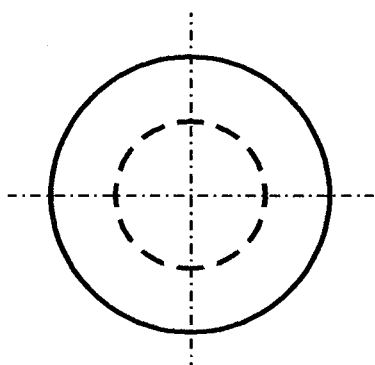
**FIGURE 2(b) - VARIANTS 02, 15, 28, 41, 54**





**FIGURE 2 - PHYSICAL DIMENSIONS (CONTINUED)**

FIGURE 2(c) - VARIANTS 03, 16, 29, 42, 55



SYMBOL	MILLIMETRES	
	MIN	MAX
A	1.41	1.85
B	0.69	1.02
B1	0.30	0.50
B2	0.05	0.13
Ød	0.61	0.66
ØD	1.22	1.32
L	0.74	0.79

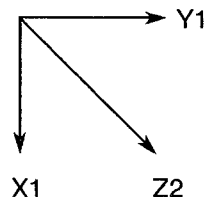
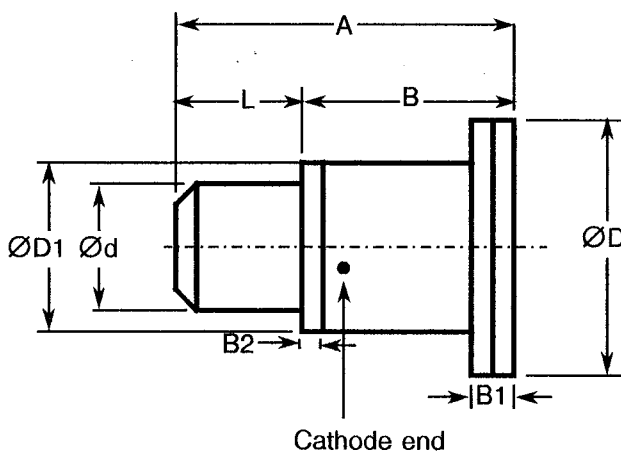
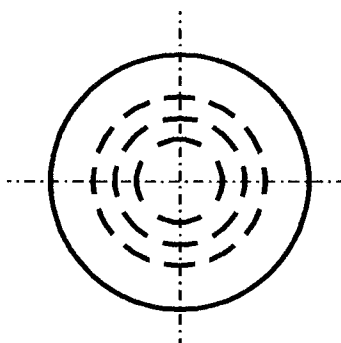
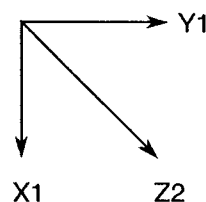


FIGURE 2(d) - VARIANTS 04, 17, 30, 43, 56



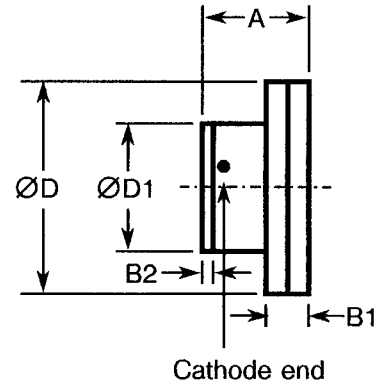
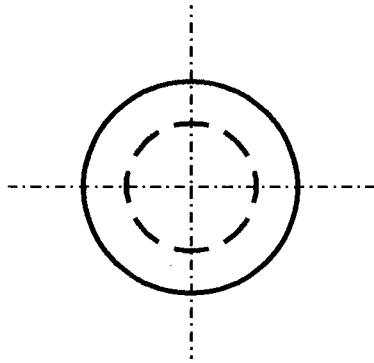
SYMBOL	MILLIMETRES	
	MIN	MAX
A	3.60	4.18
B	2.16	2.46
B1	0.41	0.61
B2	0.15	0.25
Ød	1.52	1.63
ØD	3.00	3.23
ØD1	1.95	2.11
L	1.52	1.63





**FIGURE 2 - PHYSICAL DIMENSIONS (CONTINUED)**

FIGURE 2(e) - VARIANTS 05, 18, 31, 44, 57



SYMBOL	MILLIMETRES	
	MIN	MAX
A	1.02	1.27
B1	-	0.38
B2	0.10	0.25
ØD	1.98	2.18
ØD1	1.19	1.35

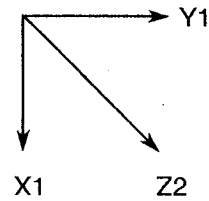
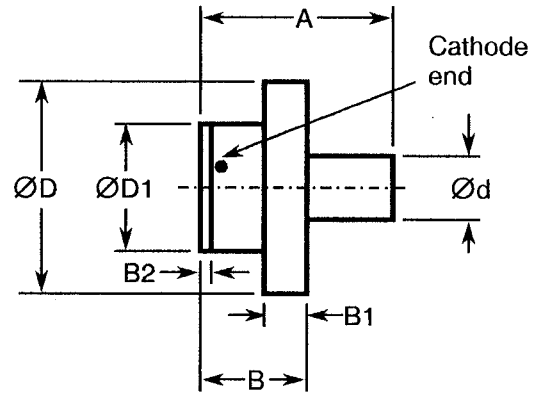
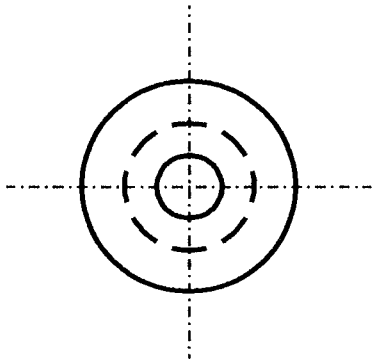
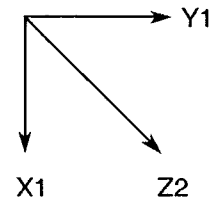


FIGURE 2(f) - VARIANTS 06, 19, 32, 45, 58

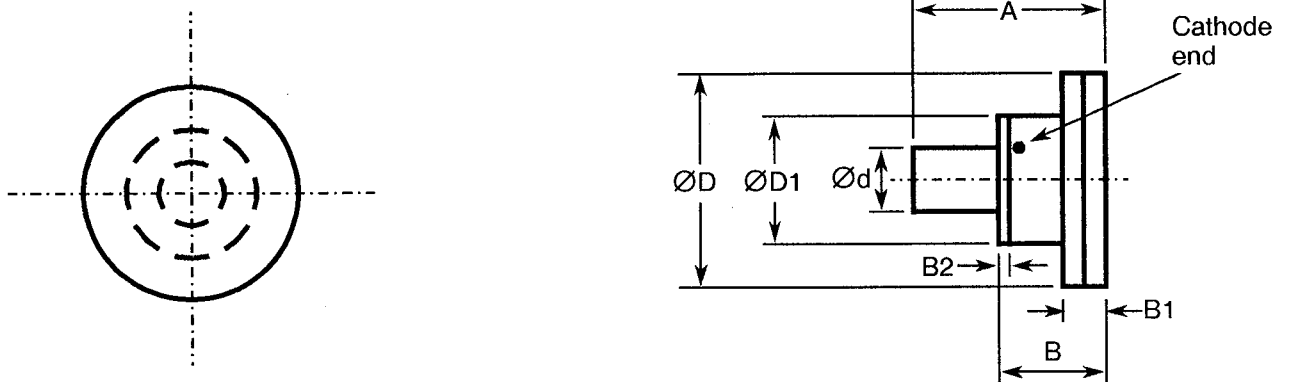


SYMBOL	MILLIMETRES	
	MIN	MAX
A	1.78	2.03
B	1.02	1.27
B1	-	0.38
B2	0.10	0.25
Ød	0.61	0.66
ØD	1.98	2.18
ØD1	1.19	1.35



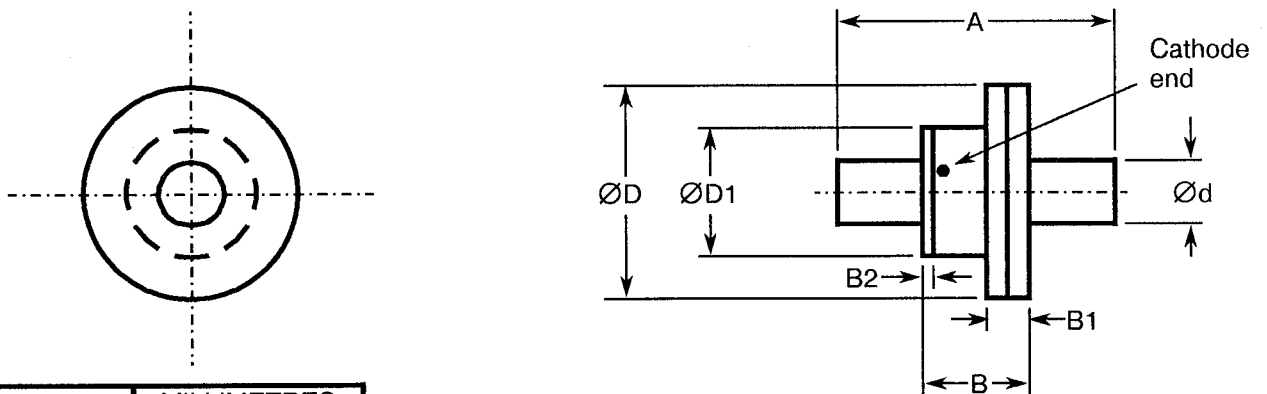
**FIGURE 2 - PHYSICAL DIMENSIONS (CONTINUED)**

FIGURE 2(g) - VARIANTS 07, 20, 33, 46, 59

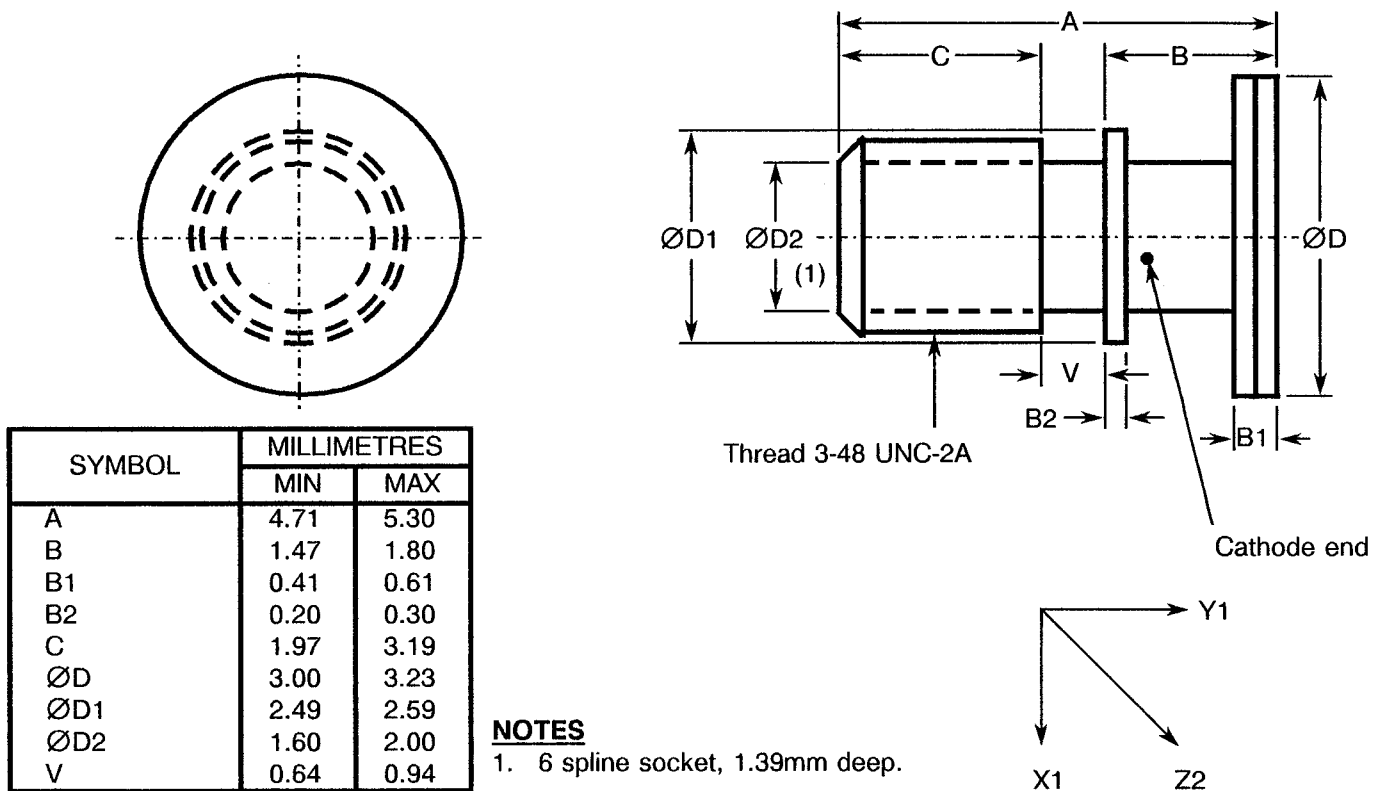
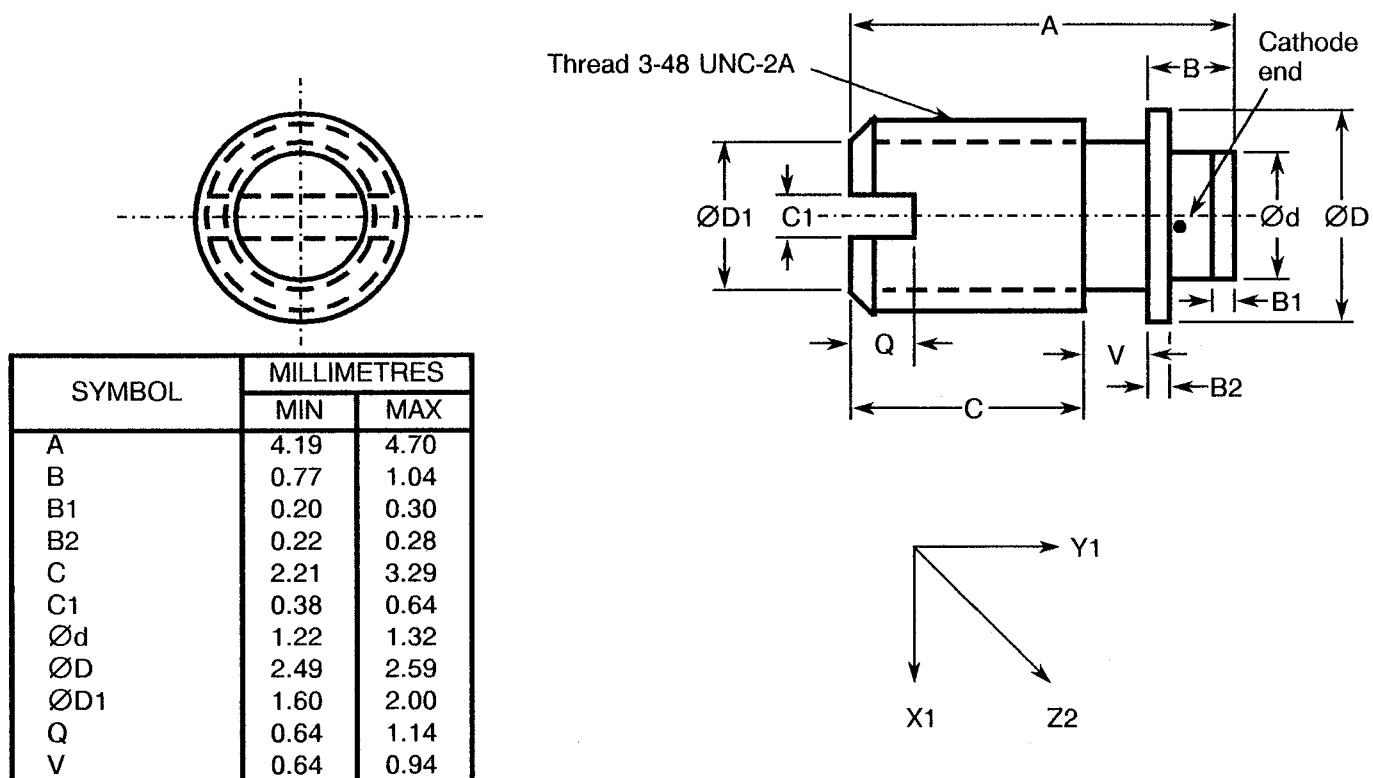


SYMBOL	MILLIMETRES	
	MIN	MAX
A	1.78	2.03
B	1.02	1.27
B1	-	0.38
B2	0.10	0.25
Ød	0.61	0.66
ØD	1.98	2.18
ØD1	1.19	1.35

FIGURE 2(h) - VARIANTS 08, 21, 34, 47, 60



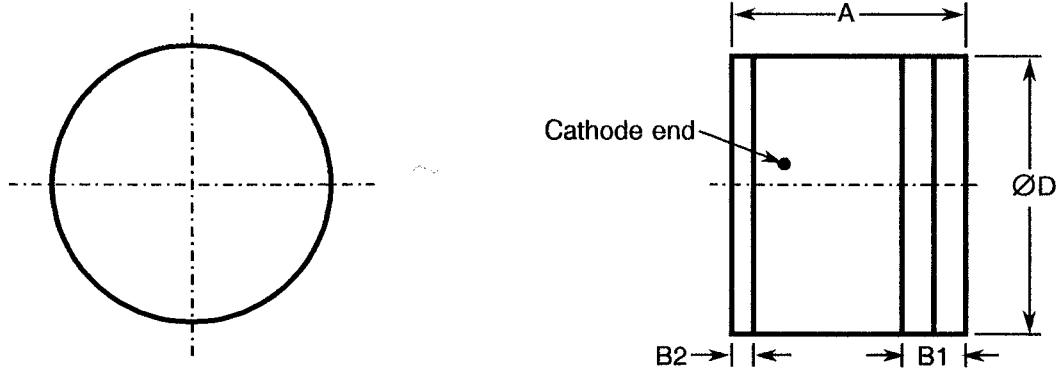
SYMBOL	MILLIMETRES	
	MIN	MAX
A	2.54	2.79
B	1.02	1.27
B1	-	0.38
B2	0.10	0.25
Ød	0.61	0.66
ØD	1.98	2.18
ØD1	1.19	1.35

**FIGURE 2 - PHYSICAL DIMENSIONS (CONTINUED)**
**FIGURE 2(i) - VARIANTS 09, 22, 35, 48, 61**

**FIGURE 2(j) - VARIANTS 10, 23, 36, 49, 62**




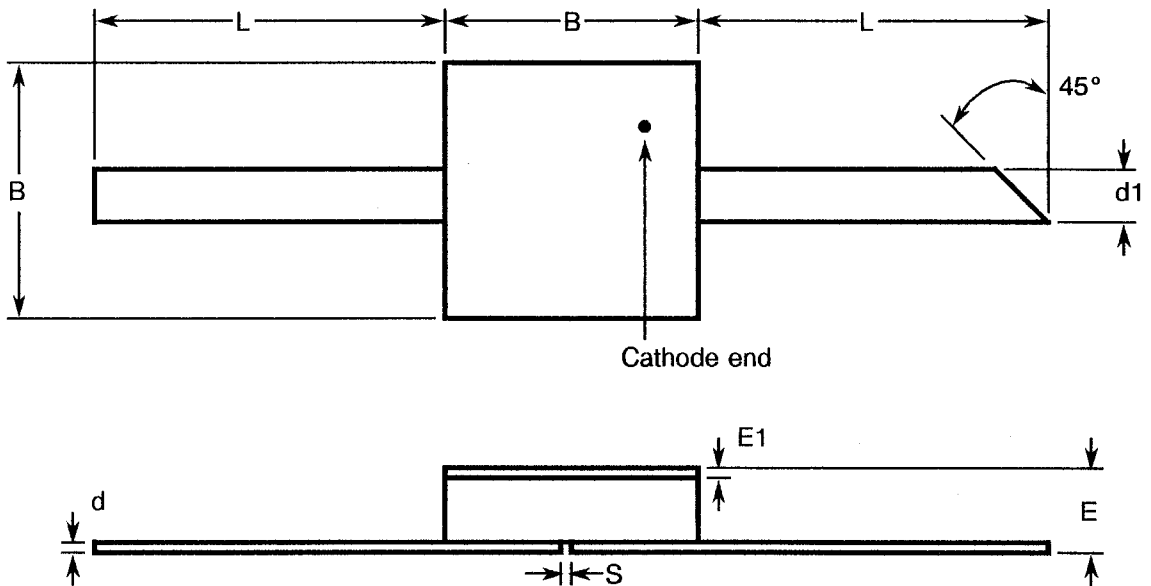
**FIGURE 2 - PHYSICAL DIMENSIONS (CONTINUED)**

FIGURE 2(k) - VARIANTS 11, 24, 37, 50, 63



SYMBOL	MILLIMETRES	
	MIN	MAX
A	1.02	1.27
B1	0.23	0.33
B2	0.10	0.15
ØD	1.29	1.40

FIGURE 2(l) - VARIANTS 12, 25, 38, 51, 64

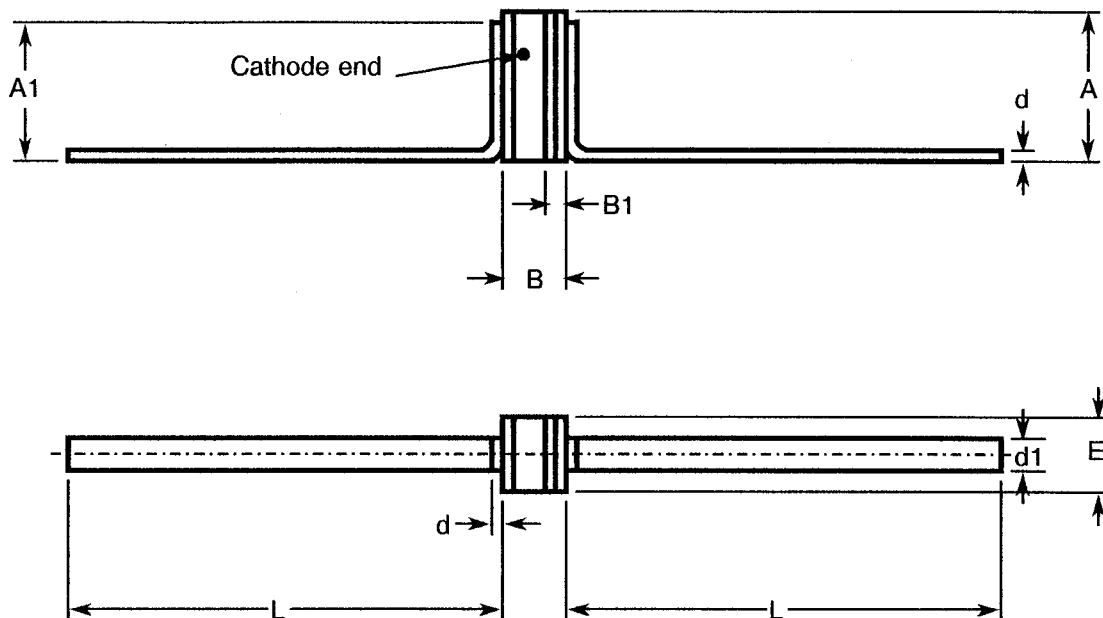


SYMBOL	MILLIMETRES	
	MIN	MAX
B	2.39	2.62
d	0.07	0.15
d1	0.48	0.56
E	0.79	1.12
E1	0.10	0.18
L	3.30	5.84
S	0.10	-

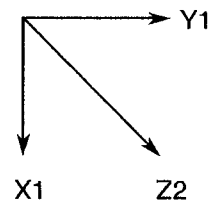


**FIGURE 2 - PHYSICAL DIMENSIONS (CONTINUED)**

FIGURE 2(m) - VARIANTS 13, 26, 39, 52, 65



SYMBOL	MILLIMETRES	
	MIN	MAX
A	1.35	2.54
A1	-	2.46
B	1.02	1.27
B1	-	0.38
d	0.07	0.15
d1	0.38	0.64
E	1.29	1.40
L	6.10	12.40



**FIGURE 3 - FUNCTIONAL DIAGRAM**



- 1. Anode
- 2. Cathode

**NOTES**

1. The cathode end shall be marked with a black dot or band. The marking will not be on the cathode connection but adjacent to it.



#### 4. REQUIREMENTS

##### 4.1 GENERAL

The complete requirements for procurement of the diodes specified herein shall be as stated in this specification and ESA/SCC Generic Specification No. 5010 for Discrete Microwave Semiconductor Components. Deviations from the Generic Specification applicable to this specification only, are listed in Para. 4.2.

Deviations from the applicable Generic Specification and this Detail Specification, formally agreed with specific Manufacturers on the basis that the alternative requirements are equivalent to the ESA/SCC requirements and do not affect the components' reliability, are listed in the appendices attached to this specification.

##### 4.2 DEVIATIONS FROM GENERIC SPECIFICATION

###### 4.2.1 Deviations from Special In-process Controls

- (a) Para. 5.2.2, Total Dose Irradiation Testing: Shall be performed during qualification and extension of qualification.
- (b) Para. 5.2.2, Total Dose Irradiation Testing: Shall be performed during procurement on a lot acceptance basis at the total dose irradiation level specified in the purchase order.
- (c) Para. 5.3, Wafer Lot Acceptance: Shall be performed as an S.E.M. Inspection only.
- (d) Quality Factor Measurement (Q): 3 randomly chosen samples shall be encapsulated in the type of package shown in Figure 2(a) of this specification. After encapsulation, Quality Factor measurements shall be performed using the method shown in Figure 4 of this specification with  $V_R = -4.0V$ . The limits specified in Table 1(a) of this specification shall be met.

###### 4.2.2 Deviations from Final Production Tests (Chart II)

- (a) Para. 9.14, Vibration, Variable Frequency: Shall not be performed.

###### 4.2.3 Deviations from Burn-in and Electrical Measurements (Chart III)

- (a) Para. 7.1.1(a), High Temperature Reverse Bias Burn-in: Shall be performed at 32% of rated  $V_R$ .

###### 4.2.4 Deviations from Qualification Tests (Chart IV)

- (a) Para. 9.23, Special Testing: Shall not be performed.

###### 4.2.5 Deviations from Lot Acceptance Tests (Chart V)

- (a) Para. 9.23, Special Testing: Shall not be performed.

#### 4.3 MECHANICAL AND ENVIRONMENTAL REQUIREMENTS

##### 4.3.1 Dimension Check

The dimensions of the diodes specified herein shall be checked. They shall conform to those shown in Figure 2.

**4.3.2 Weight**

The maximum weight of the diodes specified herein shall be:

Variant No.	Weight (g)
01, 14, 27, 40, 53	0.12
02, 15, 28, 41, 54	0.06
03, 16, 29, 42, 55	0.01
04, 17, 30, 43, 56	0.10
05, 18, 31, 44, 57	0.013
06, 07, 19, 20, 32, 33, 45, 46, 58, 59	0.015

Variant No.	Weight (g)
08, 21, 34, 47, 60	0.022
09, 10, 22, 23, 35, 36, 48, 49, 61, 62	0.14
11, 24, 37, 50, 63	0.014
12, 25, 38, 51, 64	0.06
13, 26, 39, 52, 65	0.025

**4.3.3 Terminal Strength**

The requirements for terminal strength testing are specified in Section 9 of ESA/SCC Generic Specification No. 5010. The test conditions shall be as follows:-

**(a) Condition: 'A' (Tension)**

Variants 12, 25, 38, 51 and 64:

- Force: 5.1N.
- Duration: 5 seconds.

Variants 13, 26, 39, 52 and 65:

- Force: 1.22N.
- Duration: 5 seconds.

**(b) Condition: 'D2' (Stud Torque)**

Variants 09, 22, 35, 48 and 61:

- Torque: 56mNm.
- Duration: 5 seconds.

Variants 10, 23, 36, 49 and 62:

- Torque: 42mNm.
- Duration: 5 seconds.

**(c) Condition: Compression**

Variants 01, 02, 04, 09, 14, 15, 17, 21, 27, 28, 30, 35, 40, 41, 43, 48, 53, 54, 56 and 61:

- Force: 50N.
- Duration: 5 seconds.

Variants 03, 05, 06, 07, 08, 10, 11, 16, 18, 19, 20, 21, 23, 24, 29, 31, 32, 33, 34, 36, 37, 42, 44, 45, 46, 47, 49, 50, 55, 57, 58, 59, 60 and 62:

- Force: 10N.
- Duration: 5 seconds.

The compression test shall be performed by applying the specified force to the end-cap by means of a suitable weight applied for the specified time. On completion of the test, a visual examination shall be performed to check for damage to the end-cap or the ceramic body.



#### 4.3.4 Bond Strength

The requirements for bond strength are as specified in Section 9 of ESA/SCC Generic Specification No. 5010. The test conditions shall be as follows:

- (a) Condition : 'A'.
- (b) Separating Force : 0.02N minimum.

#### 4.3.5 Die Shear

The requirements for die shear are as specified in Section 9 of ESA/SCC Generic Specification No. 5010. The test conditions shall be as follows:

- (a) Force : 0.45N minimum.

### 4.4 MATERIALS AND FINISHES

The materials and finishes shall be as specified herein. Where a definite material is not specified, a material which will enable the diodes specified herein to meet the performance requirements of this specification shall be used. Acceptance or approval of any constituent material shall not guarantee acceptance of the finished product.

#### 4.4.1 Case

The case shall be hermetically sealed and have a ceramic body. The lid shall be brazed, welded or preform soldered.

#### 4.4.2 Lead Materials and Finish

- (a) For Variants 01, 02, 04, 05, 06, 07, 08, 09, 14, 15, 17, 18, 19, 20, 21, 22, 27, 28, 30, 31, 32, 33, 34, 35, 40, 41, 43, 44, 45, 46, 47, 48, 53, 54, 56, 57, 58, 59, 60 and 61, the body material shall be Type 'A' with Type '7' finish and the lid material shall be Type 'D' with Type '2' finish, in accordance with the requirements of ESA/SCC Basic Specification No. 23500.
- (b) For Variants 03, 10, 16, 23, 29, 36, 42, 49, 55 and 62, the lead material shall be Type 'A' with Type '7' finish in accordance with the requirements of ESA/SCC Basic Specification No. 23500.
- (c) For Variants 11, 12, 13, 24, 25, 26, 37, 38, 39, 50, 51, 52, 63, 64 and 65, the lead material shall be Type 'D' with Type '2' finish in accordance with the requirements of ESA/SCC Basic Specification No. 23500.

### 4.5 MARKING

#### 4.5.1 General

The marking of components delivered to this specification shall be in accordance with the requirements of ESA/SCC Basic Specification No. 21700 and the following paragraphs. When the component is too small to accommodate all of the marking specified, as much as space permits shall be marked and the marking information, in full, shall accompany the component in its primary package.

The information to be marked and the order of precedence, shall be as follows:-

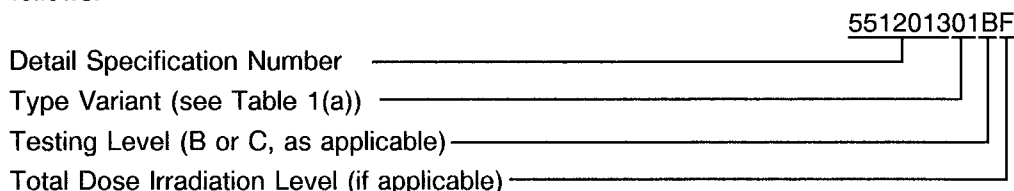
- (a) Cathode Identification.
- (b) The SCC Component Number.
- (c) Traceability Information.

#### 4.5.2 Cathode Identification

Cathode identification shall be as shown in Figures 2 and 3 of this specification.

#### 4.5.3 The SCC Component Number

Each component shall bear the SCC Component Number which shall be constituted and marked as follows:



The Total Dose Irradiation Level designation shall be added for those devices for which a sample has been successfully tested to the level in question. For these devices, a code letter shall be added in accordance with the requirements of ESA/SCC Basic Specification No. 22900.

#### 4.5.4 Traceability Information

Each component shall be marked in respect of traceability information as defined in ESA/SCC Basic Specification No. 21700.

### 4.6 ELECTRICAL MEASUREMENTS

#### 4.6.1 Electrical Measurements at Room Temperature

The parameters to be measured at room temperature are scheduled in Table 2. Unless otherwise specified, the measurements shall be performed at  $T_{amb} = +22 \pm 3$  °C.

#### 4.6.2 Electrical Measurements at High and Low Temperatures

The parameters to be measured at high and low temperatures are scheduled in Table 3. Unless otherwise specified, the measurements shall be performed at  $T_{amb} = +125(+0 - 3)$  °C.

#### 4.6.3 Circuits for Electrical Measurements

A circuit for use in performing the quality factor measurement is shown in Figure 4.

### 4.7 BURN-IN TESTS

Burn-in shall be Category 1 of Chart III(a).

#### 4.7.1 Parameter Drift Values

The parameter drift values applicable to burn-in are specified in Table 4 of this specification. Unless otherwise stated, the measurements shall be performed at  $T_{amb} = +22 \pm 3$  °C. The parameter drift values ( $\Delta$ ) applicable to the scheduled parameters shall not be exceeded. In addition to these drift value requirements for a given parameter, the appropriate limit value specified in Table 2 shall not be exceeded.

#### 4.7.2 Conditions for High Temperature Reverse Bias Burn-in

The requirements for the high temperature reverse bias burn-in are specified in Section 7 of ESA/SCC Generic Specification No. 5010. The conditions for high temperature reverse bias burn-in shall be as specified in Table 5(a) of this specification.

#### 4.7.3 Electrical Circuit for High Temperature Reverse Bias Burn-in

The circuit for use in performing the H.T.R.B burn-in test is shown in Figure 5 of this specification.

**TABLE 2 - ELECTRICAL MEASUREMENTS AT ROOM TEMPERATURE - D.C. PARAMETERS**

No.	CHARACTERISTICS	SYMBOL	MIL-STD-750 TEST METHOD	TEST CONDITIONS	LIMITS		UNIT
					MIN.	MAX.	
1	Reverse Current 1	$I_{R1}$	4016	$V_R = -25V$	-	10	$\mu A$
2	Reverse Current 2	$I_{R2}$	4016	$V_R = -16V$	-	100	nA
3	Forward Voltage	$V_F$	4011	$I_F = 10\mu A$	-	1.1	V

**TABLE 2 - ELECTRICAL MEASUREMENTS AT ROOM TEMPERATURE - A.C. PARAMETERS**

No.	CHARACTERISTICS	SYMBOL	MIL-STD-750 TEST METHOD	TEST CONDITIONS	LIMITS		UNIT
					MIN.	MAX.	
4	Total Capacitance	$C_T$	4001	$V_R = -4.0V$ $f = 1.0MHz$	Note 1		pF
5	Total Capacitance Ratio	-	4001	$V_R = 0V$ $V_R = -25V$ $f = 1.0MHz$ Note 2 Variants 01 to 13 Variants 14 to 26 Variants 27 to 39 Variants 40 to 52 Variants 53 to 65	5.5 6.0 7.0 8.5 9.0	- - - - -	

**NOTES**

1. See Column 4 of Table 1(a).
2. Ratio =  $\frac{C_T \text{ at } V_R = 0V}{C_T \text{ at } V_R = -25V}$

**TABLE 3 - ELECTRICAL MEASUREMENTS AT HIGH AND LOW TEMPERATURES**

No.	CHARACTERISTICS	SYMBOL	MIL-STD-750 TEST METHOD	TEST CONDITIONS	LIMITS		UNIT
					MIN.	MAX.	
6	Reverse Current 3	$I_{R3}$	4016	$V_R = -8.0V$	-	10	$\mu A$

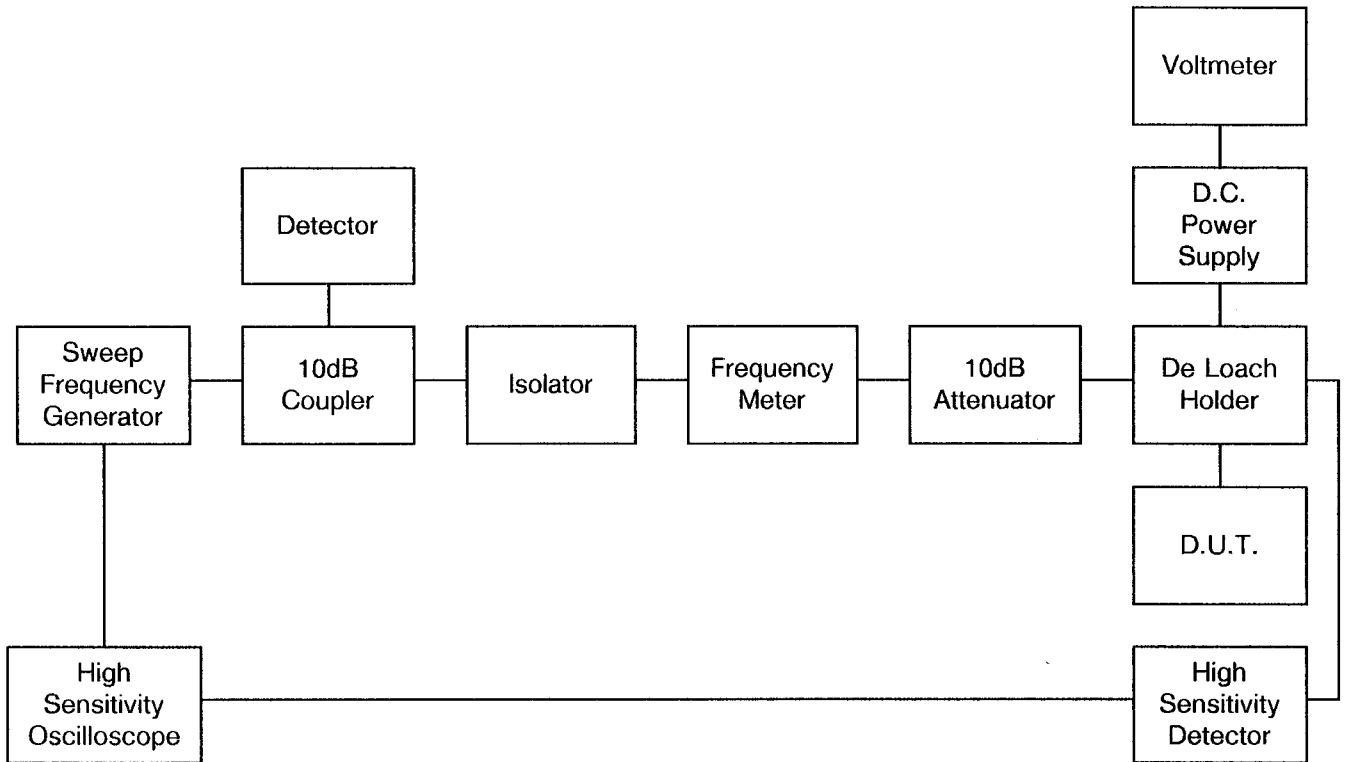
**TABLE 4 - PARAMETER DRIFT VALUES**

No.	CHARACTERISTICS	SYMBOL	SPEC.AND/OR TEST METHOD	TEST CONDITIONS	CHANGE LIMITS ( $\Delta$ )	UNIT
2	Reverse Current 2	$I_{R2}$	As per Table 2	As per Table 2	$\pm 10$ (1) or (2) $\pm 100$ (1)	nA %
3	Forward Voltage	$V_F$	As per Table 2	As per Table 2	$\pm 100$ (1)	mV

**NOTES**

1.  $\Delta 1 = \Delta 2$ .
2. Whichever is the greater, referred to the initial measurement.

**FIGURE 4 - CIRCUITS FOR ELECTRICAL MEASUREMENTS**





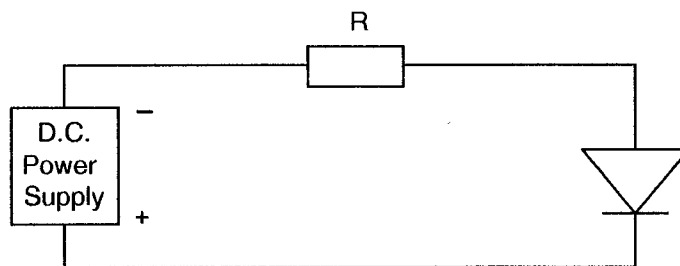
**TABLE 5(a) - CONDITIONS FOR HIGH TEMPERATURE REVERSE BIAS BURN-IN**



No.	CHARACTERISTICS	SYMBOL	CONDITIONS	UNIT
1	Ambient Temperature	$T_{amb}$	+ 125( + 0 - 3)	°C
2	Reverse Voltage	$V_R$	- 8.0	V

**TABLE 5(b) - CONDITIONS FOR OPERATING LIFE TESTS**

No.	CHARACTERISTICS	SYMBOL	CONDITIONS	UNIT
1	Ambient Temperature 1	$T_{amb1}$	+ 115( + 0 - 3)	°C
2	Reverse Voltage 1	$V_{R1}$	- 8.0	V
3	Ambient Temperature 2	$T_{amb2}$	+ 125( + 0 - 3)	°C
4	Reverse Voltage 2	$V_{R2}$	- 8.0	V

**FIGURE 5 - ELECTRICAL CIRCUIT FOR HIGH TEMPERATURE REVERSE BIAS BURN-IN AND OPERATING LIFE TESTS**



 	<p style="text-align: center;">ESA/SCC Detail Specification No. 5512/013</p>		<p>PAGE 24 ISSUE 1</p>
---	--	--	----------------------------

4.8 ENVIRONMENTAL AND ENDURANCE TESTS (CHARTS IV AND V OF ESA/SCC GENERIC SPECIFICATION NO. 5010)

4.8.1 Electrical Measurements on Completion of Environmental Tests

The parameters to be measured on completion of environmental tests are scheduled in Table 2. Unless otherwise stated, the measurements shall be performed at  $T_{amb} = +22 \pm 3$  °C.

4.8.2 Electrical Measurements at Intermediate Points and on Completion of Endurance Tests

The parameters to be measured at intermediate points and on completion of endurance tests are scheduled in Table 6. Unless otherwise stated, the measurements shall be performed at  $T_{amb} = +22 \pm 3$  °C.

4.8.3 Conditions for Operating Life Tests (Part of Endurance Testing)

The requirements for operating life testing are specified in Section 9 of ESA/SCC Generic Specification No. 5010. The conditions for operating life testing are specified in Table 5(b) of this specification.

4.8.4 Electrical Circuits for Operating Life Tests

The circuit to be used for performance of the operating life test shall be the same as shown in Figure 5 for High Temperature Reverse Bias Burn-in.

4.9 TOTAL DOSE IRRADIATION TESTING

4.9.1 Application

If specified in Para. 4.2.1 of this specification, total dose irradiation testing shall be performed in accordance with the requirements of ESA/SCC Basic Specification No. 22900.

4.9.2 Bias Conditions

Continuous bias shall be applied during irradiation testing as shown in Figure 6 of this specification.

4.9.3 Electrical Measurements

The parameters to be measured prior to irradiation exposure are scheduled in Table 2 of this specification. Only devices which meet the requirements of Table 2 shall be included in the test sample.

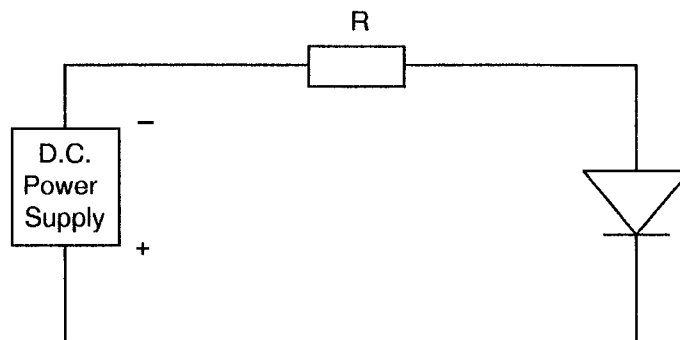
The parameters to be measured during and on completion of irradiation testing are scheduled in Table 7 of this specification.

4.10 SPECIAL TESTING

Not applicable.

**TABLE 6 - ELECTRICAL MEASUREMENTS AT INTERMEDIATE POINTS AND ON COMPLETION OF ENDURANCE TESTING**

No.	CHARACTERISTICS	SYMBOL	SPEC. AND/OR TEST METHOD	TEST CONDITIONS	LIMITS		UNIT
					MIN.	MAX.	
1	Reverse Current 1	$I_{R1}$	As per Table 2	As per Table 2	As per Table 2		$\mu$ A
2	Reverse Current 2	$I_{R2}$	As per Table 2	As per Table 2	As per Table 2		nA
3	Forward Voltage	$V_F$	As per Table 2	As per Table 2	As per Table 2		V
4	Total Capacitance	$C_T$	As per Table 2	As per Table 2	As per Table 2		pF

**FIGURE 6 - BIAS CONDITIONS FOR IRRADIATION TESTING****NOTES**

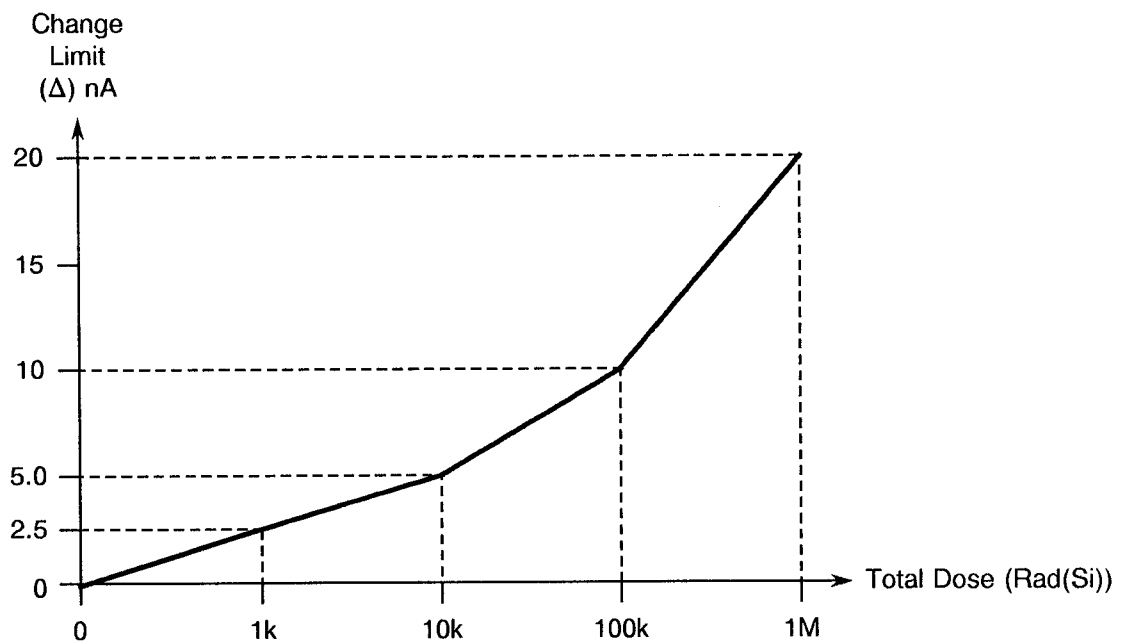
1. A reverse bias of  $V_R = -8.0V$ , shall be applied.


**TABLE 7 - ELECTRICAL MEASUREMENTS DURING AND ON COMPLETION OF IRRADIATION TESTING**

No.	CHARACTERISTICS	SYMBOL	SPEC. AND/OR TEST METHOD	TEST CONDITIONS	CHANGE LIMITS ( $\Delta$ )	UNIT
2	Reverse Current 2	$I_{R2}$	As per Table 2	As per Table 2	Note 1	nA

**NOTES**

- The graph given below shall be used to determine the maximum permitted change.



	<p>ESA/SCC Detail Specification No. 5512/013</p>		<p>PAGE 27 ISSUE 1</p>
---	--	--	----------------------------

**APPENDIX 'A'**

Page 1 of 1

AGREED DEVIATIONS FOR M/A-Com LTD. (G.B.)

ITEMS AFFECTED	DESCRIPTION OF DEVIATIONS
Para. 4.2.2	Para. 9.4, "High Temperature Stabilisation Bake": May be performed at +125(+0-3) °C.