



europaean space agency  
agence spatiale européenne

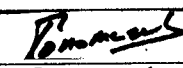
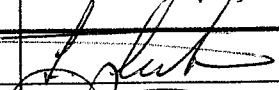
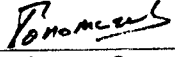

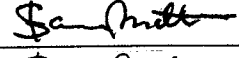

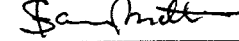

Pages 1 to 32

**CAPACITORS, FIXED, GLASS DIELECTRIC**

**ESA/SCC Generic Specification No. 3004**



**space components  
coordination group**

Issue/Rev.	Date	Approved by	
		SCCG Chairman	ESA Director General or his Deputy
Issue 2	September 1993		
Revision 'A'	June 1995		
Revision 'B'	June 1997		
Revision 'C'	April 1999		





**DOCUMENTATION CHANGE NOTICE**

Rev. Letter	Rev. Date	Reference	CHANGE Item	Approved DCR No.
		P26. Para. 10.1	: "(when applicable)" added to (h)	23853
		Para. 10.1.2	: Existing text deleted and new text added	23853
		Para. 10.1.3	: Moved to Page 26A	None
		P26A.	: Page added	None
		Para. 10.1.3	: Title added from Page 26, existing text deleted and new text added	23853
		Para. 10.1.4	: New paragraph added	23853
		P27. Para. 10.2	: (e) amended	23853
		Para. 10.3	: First sentence amended	23853
		Para. 10.6	: In the second paragraph, second sentence amended	23853
			: Last paragraph deleted	23853
		P28. Para. 10.7.1	: In the second sentence, "provided" replaced by "recorded"	23853
		Para. 10.7.2	: In the text, "provided" replaced by "prepared"	23853
		P29. Para. 11	: In (b), "(when applicable)," added after "testing"	23853
			: In the last sentence, ", when requested," added after "copied"	23853
'C'	Apr. '99	P1. Cover Page		None
		P2A. DCN		None
		P13. Para. 8.2.1	: New second sentence added to last paragraph	21111
		P26. Para. 10.1.2.1	: Item (b), "PDA figure and" deleted from text	21119
			: Item (c) rewritten	21119
		P26A. Para. 10.1.3.1	: Item (a), "(including PDA figure)" deleted	21119

**TABLE OF CONTENTS**



	<u>Page</u>
<b>1. <u>INTRODUCTION</u></b>	<b>6</b>
1.1 Scope	6
1.2 Applicability	6
<b>2. <u>APPLICABLE DOCUMENTS</u></b>	<b>6</b>
2.1 ESA/SCC Specifications	6
2.2 Other (Reference) Documents	7
2.3 Order of Precedence	
<b>3. <u>TERMS, DEFINITIONS, ABBREVIATIONS, SYMBOLS AND UNITS</u></b>	<b>7</b>
<b>4. <u>REQUIREMENTS</u></b>	<b>7</b>
4.1 General	7
4.1.1 Specifications	7
4.1.2 Conditions and Methods of Test	7
4.1.3 Manufacturer's Responsibility for Performance of Tests and Inspections	7
4.1.4 Inspection Rights	8
4.1.5 Pre-encapsulation Inspection	8
4.2 Qualification Approval Requirements on a Manufacturer	8
4.3 Deliverable Components	8
4.3.1 Lot Failure	8
4.3.2 Testing and Lot Acceptance Levels	9
4.4 Marking	9
4.5 Materials and Finishes	9
<b>5. <u>PRODUCTION CONTROL</u></b>	<b>9</b>
5.1 General	9
5.2 Special In-process Controls	9
<b>6. <u>FINAL PRODUCTION TESTS</u></b>	<b>11</b>
6.1 General	11
6.2 Test Methods and Conditions	11
6.3 Documentation	11
<b>7. <u>BURN-IN AND ELECTRICAL MEASUREMENTS</u></b>	<b>11</b>
7.1 General	11
7.1.1 Conditions of Test	11
7.1.2 Data Points	11
7.2 Failure Criteria	11
7.2.1 Parameter Drift Failure	11
7.2.2 Parameter Limit Failure	12
7.2.3 Other Failures	12
7.3 Failed Components	12
7.4 Lot Failure	12
7.4.1 Lot Failure during 100% Testing	12
7.4.2 Lot Failure during Sample Testing	12
7.5 Documentation	12



	<u>Page</u>
<b>8. <u>QUALIFICATION APPROVAL AND LOT ACCEPTANCE TESTS</u></b>	<b>13</b>
8.1 Qualification Testing	13
8.1.1 General	13
8.1.2 Distribution within the Qualification Test Lot	13
8.2 Lot Acceptance Testing	13
8.2.1 General	13
8.2.2 Distribution within the Sample for Lot Acceptance Testing	13
8.2.3 Lot Acceptance Level 3 Testing	14
8.2.4 Lot Acceptance Level 2 Testing	14
8.2.5 Lot Acceptance Level 1 Testing	14
8.3 Failure Criteria	14
8.3.1 Environmental and Mechanical Test Failures	14
8.3.2 Electrical Failures	15
8.3.3 Other Failures	15
8.4 Failed Components	15
8.5 Lot Failure	15
8.6 Documentation	15
<b>9. <u>TEST METHODS AND PROCEDURES</u></b>	<b>20</b>
9.1 Internal Visual Inspection	20
9.2 High Voltage Stabilisation	20
9.3 Electrical Measurements	20
9.3.1 General	20
9.3.2 Parameter Drift Value Measurements	21
9.3.3 Electrical Measurements at High and Low Temperatures	21
9.3.4 Electrical Measurements at Room Temperature	21
9.3.5 Parameter Measurements during Endurance Testing	21
9.4 External Visual Inspection	21
9.5 Dimension Check	21
9.6 Seal Test	21
9.7 Thermal Shock	22
9.8 Moisture Resistance	22
9.9 Shock	22
9.10 Vibration	23
9.11 Solderability	23
9.12 Terminal Strength	23
9.13 Barometric Pressure	24
9.14 Temperature Coefficient and Capacitance Drift	24
9.14.1 Temperature Coefficient	24
9.14.2 Capacitance Drift	25
9.15 Resistance to Soldering Heat	25
9.16 Operating Life	25
9.17 Permanence of Marking	25
9.18 Sealing	25
<b>10. <u>DATA DOCUMENTATION</u></b>	<b>26</b>
10.1 General	26
10.1.1 Qualification Approval	26
10.1.2 Testing Level "B"	26
10.1.3 Testing Level "C"	26A
10.1.4 Data Retention/Data Access	26A
10.2 Cover Sheet(s)	27
10.3 List of Equipment Used	27



	<u>Page</u>
10.4 List of Test References	27
10.5 Special In-process Control Data	27
10.6 Final Production Test Data	27
10.7 Burn-in and Electrical Measurement Data	28
10.7.1 Testing Level "B"	28
10.7.2 Testing Level "C"	28
10.8 Qualification Test Data	28
10.9 Lot Acceptance Test Data	28
10.9.1 Testing Level "B"	28
10.9.2 Testing Level "C"	28
10.10 Failed Components List and Failure Analysis Report	29
10.11 Certificate of Conformity	29
<b>11. <u>DELIVERY</u></b>	<b>29</b>
<b>12. <u>PACKAGING AND DESPATCH</u></b>	<b>29</b>
<b><u>CHARTS</u></b>	
I TESTING LEVELS	10
II FINAL PRODUCTION TESTS	16
III BURN-IN AND ELECTRICAL MEASUREMENTS	17
IV QUALIFICATION TESTS	18
V LOT ACCEPTANCE TESTS	19
<b><u>FIGURES</u></b>	
I BEND TEST	24
<b><u>ANNEXES</u></b>	
I LTPD SAMPLING PLAN FOR LOT SIZES GREATER THAN 200 DEVICES	30
LTPD SAMPLING PLAN FOR LOT SIZES LESS THAN OR EQUAL TO 200 DEVICES	31

		<p style="text-align: center;">ESA/SCC Generic Specification No. 3004</p>	<p style="text-align: center;">Rev. 'A'</p>	<p>PAGE 6 ISSUE 2</p>
---	---	---	---	---------------------------

## 1. INTRODUCTION

### 1.1 SCOPE

This specification defines the general requirements for the qualification approval, procurement, including lot acceptance testing, and delivery of Capacitors, Fixed, Glass Dielectric, for space applications.

This specification contains the appropriate inspection and test schedules and also specifies the data documentation requirements.

### 1.2 APPLICABILITY

This specification is primarily applicable to the granting of qualification approval to a component in accordance with ESA/SCC Basic Specification No. 20100 and the procurement of such components from qualified Manufacturers.

## 2. APPLICABLE DOCUMENTS

The following documents form part of, and shall be read in conjunction with, this specification. The relevant issues shall be those in effect on the date of placing the purchase order.

### 2.1 ESA/SCC SPECIFICATIONS

No. 20100, Requirements for the Qualification of Standard Electronic Components for Space Application.

No. 20400, Internal Visual Inspection.

No. 20500, External Visual Inspection.

No. 20600, Preservation, Packaging and Despatch of SCC Electronic Components.

No. 21300, Terms, Definitions, Abbreviations, Symbols and Units.

No. 21700, General Requirements for the Marking of SCC Components.

No. 22800, ESA/SCC Non-conformance Control System.

No. 23500, Lead Materials and Finishes for Components for Space Application.



No. 24600, Minimum Quality System Requirements.

No. 24800, Resistance to Solvents of Marking, Materials and Finishes.

With the exception of ESA/SCC Basic Specifications Nos. 20100, 21700, 22800 and 24600, where Manufacturers' specifications are equivalent to, or more stringent than, the ESA/SCC Basic Specifications listed above, they may be used in place of the latter, subject to the approval of the appropriate Qualifying Space Agency.

Such replacements shall be clearly identified in the applicable Process Identification Document (P.I.D.) and listed in an Appendix to the appropriate Detail Specification.

Unless otherwise stated herein, references within the text of this specification to "the Detail Specification" shall mean the relevant ESA/SCC Detail Specification.

		<p style="text-align: center;">ESA/SCC Generic Specification No. 3004</p>	<p style="text-align: center;">Rev. 'B'</p>	<p>PAGE 7 ISSUE 2</p>
---	---	---	---	---------------------------

## 2.2 OTHER (REFERENCE) DOCUMENTS

MIL-STD-105, Sampling Procedures and Tables for Inspection by Attributes.

MIL-STD-202, Test Methods for Electronic and Electrical Component Parts.

MIL-STD-414, Sampling Procedures and Tables for Inspection by Variables for Percent Defective.

ESA PSS-01-702, A Thermal Vacuum Test for the Screening of Space Materials.

## 2.3 ORDER OF PRECEDENCE

For the purpose of interpretation and in case of conflict with regard to documentation, the following order of precedence shall apply:-

- (a) ESA/SCC Detail Specification.
- (b) ESA/SCC Generic Specification.
- (c) ESA/SCC Basic Specification.
- (d) Other documents, if referenced herein.

## 3. TERMS, DEFINITIONS, ABBREVIATIONS, SYMBOLS AND UNITS

The terms, definitions, abbreviations, symbols and units specified in ESA/SCC Basic Specification No. 21300 shall apply.

## 4. REQUIREMENTS

### 4.1 GENERAL

The test requirements for qualification approval of a component shall comprise final production tests (see Chart II), burn-in and electrical measurements to testing level "B" (see Chart III) and qualification testing (see Chart IV).

The test requirements for procurement of components shall comprise final production tests (Chart II), burn-in and electrical measurements to testing level "B" or "C" as required (Chart III) together with, when applicable, a level of lot acceptance testing (see Chart V) to be specified by the Orderer.

If a Manufacturer elects to eliminate a final production test by substituting an in-process control or statistical process control procedure, the Manufacturer is still responsible for delivering components that meet all of the performance, quality and reliability requirements defined in this specification and the Detail Specification.

#### 4.1.1 Specifications

For qualification approval, procurement (including lot acceptance testing) and delivery of components in conformity with this specification, the specifications listed in Section 2 of this document shall apply in total unless otherwise specified herein or in the Detail Specification.

#### 4.1.2 Conditions and Methods of Test

The conditions and methods of test shall be in accordance with this specification, the ESA/SCC Basic Specifications referenced herein and the Detail Specification.

#### 4.1.3 Manufacturer's Responsibility for Performance of Tests and Inspections

The Manufacturer shall be responsible for the performance of tests and inspections required by the applicable specifications. These tests and inspections shall be performed at the plant of the Manufacturer of the components unless it is agreed by the Qualifying Space Agency prior to commencing qualification testing, or procurement, to use an approved external facility.



**SCC**ESA/SCC Generic Specification  
No. 3004

Rev. 'B'

PAGE 8

ISSUE 2

#### 4.1.4 Inspection Rights

The Qualifying Space Agency (for qualification approval or for a procurement) reserves the right to monitor any of the tests and inspections scheduled in the applicable specifications.

#### 4.1.5 Pre-encapsulation Inspection

The Manufacturer shall notify the Order at least 2 working weeks before the commencement of Pre-encapsulation Inspection. The Order shall indicate immediately whether or not he intends to witness the inspection.

#### 4.2 QUALIFICATION APPROVAL REQUIREMENTS ON A MANUFACTURER

To obtain and maintain the qualification approval of a component, or family of components, a Manufacturer shall satisfy the requirements of ESA/SCC Basic Specification No. 20100.

#### 4.3 DELIVERABLE COMPONENTS

Components delivered to this specification shall be processed and inspected in accordance with the relevant Process Identification Document (P.I.D.). Each delivered component shall be traceable to its production lot. Components delivered to this specification shall have completed satisfactorily all tests to the testing level and lot acceptance level specified in the purchase order (see Para. 4.3.2).

ESA/SCC qualified components delivered to this specification shall be produced from lots that are capable of passing all tests, and sequences of tests, that are defined in Charts IV and V. The Manufacturer shall not knowingly supply components that cannot meet this requirement. In the event that, subsequent to delivery and prior to operational use, a component is found to be in a condition such that it could not have passed these tests at the time of manufacture, this shall be grounds for rejection of the delivered lot.

Components failing inspections and tests of the higher testing level (i.e level "B") shall not be supplied against any order for components of the lower testing level.

##### 4.3.1 Lot Failure

Lot failure may occur during final production tests (Chart II), burn-in and electrical measurements (Chart III), qualification testing (Chart IV) or lot acceptance testing (Chart V).

Should such failure occur, the non-conformance procedure shall be initiated in accordance with ESA/SCC Basic Specification No. 22800.

Should such failure occur during procurement, the Manufacturer shall notify the Orderer by telex within 2 working days, giving details of the number and mode of failure and the suspected cause.

In the case where qualification approval has been granted to the component, he shall, at the same time by the same means, inform the Qualifying Space Agency in order that the latter may consider its implications.

No further testing shall be performed on the failed components except on instruction from the Orderer. The Orderer shall inform the Manufacturer and the Qualifying Space Agency within 2 working days of receipt of the telex, by the same means, what action shall be taken.

In the case when lot failure occurs during qualification testing, the Manufacturer shall immediately notify the appropriate Qualifying Space Agency who will define a course of action to be followed. No further testing shall be performed on the failed components.

**SCC**ESA/SCC Generic Specification  
No. 3004

Rev. 'A'

PAGE 9

ISSUE 2

#### 4.3.2 Testing and Lot Acceptance Levels

This specification defines 2 levels of testing severity which are designated by the letters "B" and "C" (see Chart I) and 3 levels of lot acceptance testing (see Chart V).

The lot acceptance levels are designated 1, 2 and 3 and are comprised of tests as follows:-

Level 3 (LA3) - Electrical Subgroup.

Level 2 (LA2) - Endurance Subgroup  
plus Electrical Subgroup.

Level 1 (LA1) - Environmental and Mechanical Subgroup  
plus Endurance Subgroup  
plus Electrical Subgroup.

The required testing level and lot acceptance level shall both be specified in a purchase order.

#### 4.4 MARKING

All components procured and delivered to this specification from a source qualified according to ESA/SCC Basic Specification No. 20100 shall be marked in accordance with ESA/SCC Basic Specification No. 21700. Thus, they shall bear the ESA symbol to signify their conformance to the ESA/SCC qualification approval requirements and full compliance with the requirements of this specification and the Detail Specification.

Components procured from sources which are not ESA/SCC qualified, provided that they fully comply with the procurement requirements of this specification and the Detail Specification, may bear the SCC marking **with the exception of the ESA symbol.**

#### 4.5 MATERIALS AND FINISHES

All non-metallic external materials and finishes, that are not within a hermetically sealed enclosure, of the components specified herein shall meet the outgassing requirements as outlined in ESA PSS-01-702.

Specific requirements for materials and finishes are specified in the Detail Specification.

### 5. PRODUCTION CONTROL

#### 5.1 GENERAL

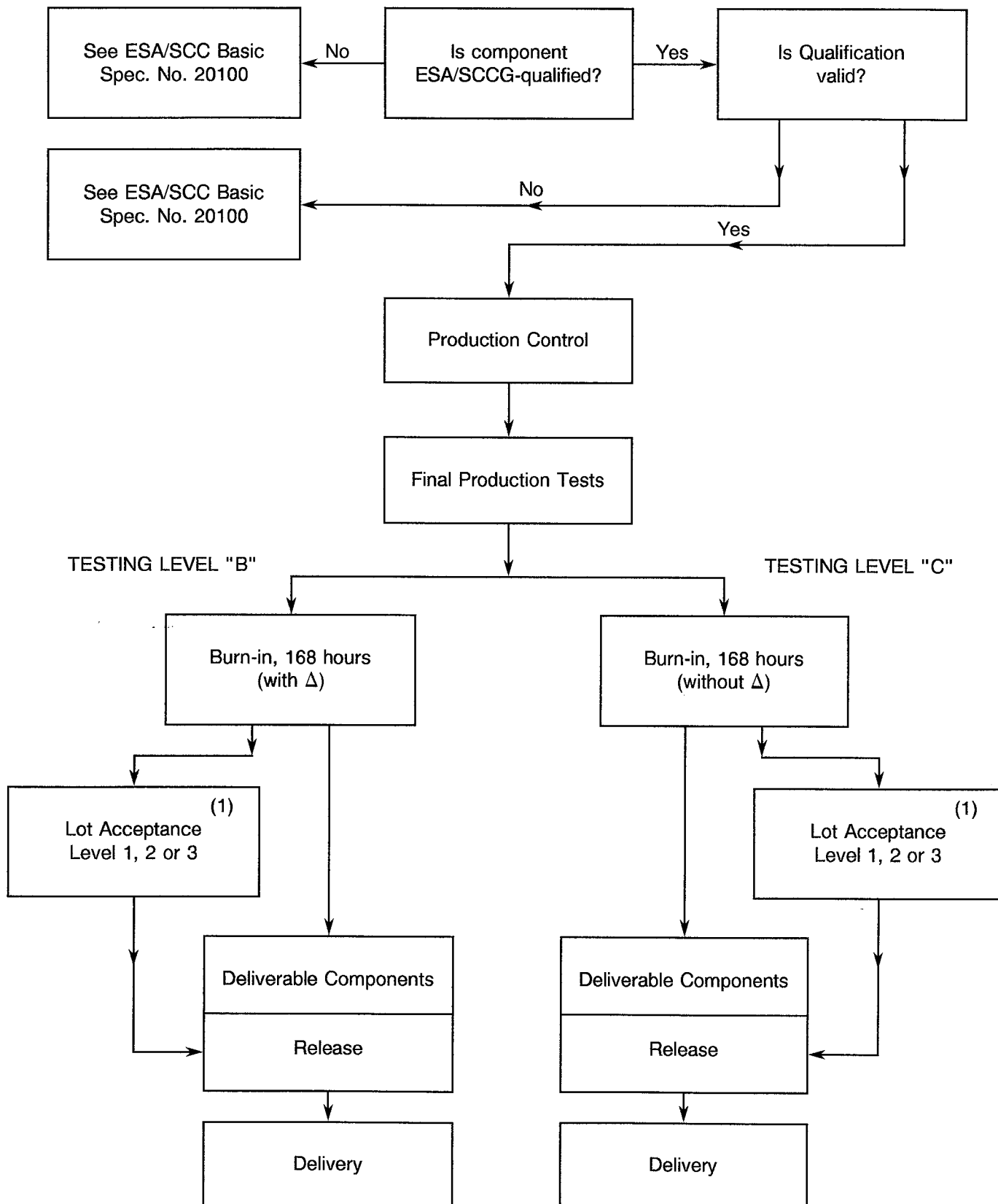
The minimum requirements for production control, which are equally applicable to procurement, are defined in ESA/SCC Basic Specification No. 20100, Para's 5.1 and 5.2.

#### 5.2 SPECIAL IN-PROCESS CONTROLS

Where applicable, special in-process controls shall apply as specified in the Detail Specification.



**CHART I - TESTING LEVELS**



**NOTES**

1. When applicable.

**6. FINAL PRODUCTION TESTS****6.1 GENERAL**

Unless otherwise specified in the Detail Specification, all components used for qualification testing and all components for delivery, including those submitted to lot acceptance tests, shall be subjected to tests and inspections in accordance with Chart II.

Unless otherwise specified in the Detail Specification, the tests shall be performed in the order shown.

Any components that do not meet these requirements shall be removed from the lot and at no future time be re-submitted to the requirements of this specification.

**6.2 TEST METHODS AND CONDITIONS**

The applicable test methods and conditions are specified in the paragraphs referenced in Chart II of this specification.

**6.3 DOCUMENTATION**

Documentation of final production test data shall be in accordance with the requirements of Para. 10.6 of this specification.

**7. BURN-IN AND ELECTRICAL MEASUREMENTS****7.1 GENERAL**

Unless otherwise specified in the Detail Specification, all components used for qualification testing and all components for delivery, including those submitted to lot acceptance tests, shall be subjected to tests and inspections in accordance with Chart III.

Unless otherwise specified in the Detail Specification, the tests shall be performed in the order shown.

The applicable test methods and conditions are specified in the paragraphs referenced in Chart III.

Components of testing level "B" shall be serialised prior to the tests and inspections.

**7.1.1 Conditions of Test**

The conditions for burn-in shall be as shown in Table 5 of the Detail Specification.

Unless otherwise specified in the Detail Specification, components of both Levels "B" and "C" shall be subjected to a total burn-in period of 168 hours.

**7.1.2 Data Points**

For components of testing level "B", undergoing a total burn-in period of 168 hours, the data points for parameter drift measurement shall be 0 hours (initial) and 168 (+24 -0) hours (final).

For components of testing level "C", undergoing a total burn-in period of 168 hours, the data point for post-burn-in electrical measurements shall be 168 (+24 -0) hours.

**7.2. FAILURE CRITERIA****7.2.1 Parameter Drift Failure**

The acceptable delta limits are shown in Table 4 of the Detail Specification. A component of testing level "B" shall be counted as a parameter drift failure if the changes during burn-in are larger than the delta ( $\Delta$ ) values specified.



### 7.2.2 Parameter Limit Failure

A component shall be counted as a limit failure if one or more parameters exceed the limits shown in Tables 2 or 3 of the Detail Specification.

Any component which exhibits a limit failure prior to the burn-in sequence shall be rejected and not counted when determining lot rejection.

### 7.2.3 Other Failures

A component shall be counted as a failure in any of the following cases:

- Mechanical failure.
- Handling failure.
- Lost component.

### 7.3 FAILED COMPONENTS

A component shall be considered as a failed component if it exhibits one or more of the failure modes described in Para. 7.2 of this specification.

### 7.4 LOT FAILURE

In case of lot failure, the Manufacturer shall act in accordance with the requirements of Para. 4.3.1 of this specification.

#### 7.4.1 Lot Failure during 100% Testing

If the number of components failed on the basis of the failure criteria described in Para. 7.2 exceeds 5% (rounded upwards to the nearest whole number) of the number of components submitted to burn-in and electrical measurements, the lot shall be considered as failed.

If a lot is composed of groups of components of one family defined in one ESA/SCC Detail Specification, but separately identifiable for any reason, then the lot failure criteria shall apply separately to each identifiable group.

#### 7.4.2 Lot Failure during Sample Testing


A lot shall be considered as failed if the number of allowable failures during sample testing, in accordance with General Inspection Level II of MIL-STD-105 and the applicable AQL as specified in the Detail Specification, is exceeded.

In the case where an LTPD to MIL-STD-414 is specified in the Detail Specification, a lot shall be considered as failed if the number of failures allowed is exceeded (see Annexe I for LTPD Sampling Plan).

If a lot failure occurs in either case, a 100% testing may be performed with the lot failure criteria given in Para. 7.4.1.

### 7.5 DOCUMENTATION

Data documentation of burn-in and electrical measurements shall be in accordance with Para. 10.7 of this specification.

	<p style="text-align: center;">ESA/SCC Generic Specification No. 3004</p>	<p style="text-align: center;">Rev. 'C'</p>	<p>PAGE 13 ISSUE 2</p>
---	---	---	----------------------------

**8. QUALIFICATION APPROVAL AND LOT ACCEPTANCE TESTS**

**8.1 QUALIFICATION TESTING**

**8.1.1 General**

Qualification testing shall be in accordance with the requirements of Chart IV of this specification. The tests to Chart IV shall be performed on the specified sample, chosen at random from components which have successfully passed the tests in Charts II and III for testing level "B". This sample constitutes the qualification test lot.

The qualification test lot is divided into subgroups of tests and all components assigned to a subgroup shall be subjected to all of the tests in that subgroup, in the sequence shown.

The applicable test requirements are detailed in the paragraphs referenced in Chart IV.

The conditions governing qualification testing are given in ESA/SCC Basic Specification No. 20100, Para. 5.3 and, for the extension or renewal of qualification approval, in Para's 6.3 and 6.4.

**8.1.2 Distribution within the Qualification Test Lot**

A sample of 90 components shall be submitted to qualification testing (Chart IV). The sample shall consist of specimens having the highest capacitance value. In the case of component types with 2 different d.c. voltage ratings, an equal number of those sample units which have the highest capacitance value per d.c. rating shall be submitted.

The selected distribution shall be agreed with the Qualifying Space Agency.

**8.2 LOT ACCEPTANCE TESTING**

**8.2.1 General**

The sample sizes of the 3 lot acceptance levels are specified in Chart V. All components assigned to a subgroup shall be subjected to all of the tests of that subgroup in the sequence shown.

The tests to Chart V shall be performed on the specified sample which shall have been chosen, whenever possible, at random from the proposed delivery lot (but see Para. 8.2.3(b)). The applicable test requirements are detailed in the paragraphs referenced in Chart V.

As a minimum for procurement of non-qualified components, lot acceptance level 3 tests shall apply. For procurement of qualified components, lot acceptance testing shall be performed if specified in a purchase order. Procurement lots ordered with a lot acceptance test level shall be delivered only after successful completion of lot acceptance testing.

**8.2.2 Distribution within the Sample for Lot Acceptance Testing**

Where a Detail Specification covers a range or series of components that are considered similar, then it may be necessary that the sample for lot acceptance testing be comprised of component types so selected that they adequately represent all of the various mechanical, structural and electrical peculiarities of the procured range or series.

The distribution of the component types will normally vary from procurement to procurement and shall be as specified by the Orderer, following as closely as possible the requirements prescribed in Para. 8.1.2. of this specification.



### 8.2.3 Lot Acceptance Level 3 Testing (LA3)

Lot acceptance level 3 tests are designated as the electrical subgroup and comprise electrical measurements of characteristics and tests to prove the assembly capability of the component. For LA3 testing, the following requirements and conditions shall apply:-

- (a) LA3 testing shall be performed by the Manufacturer's quality assurance personnel using dedicated quality assurance equipment whenever possible. LA3 testing shall not be a repetition of routine measurements made by production personnel during final production tests and burn-in and electrical measurements.
- (b) When tests to Tables 2 and 3 of the Detail Specification have been performed on a sample basis, then the components for LA3 testing shall be selected from this sample.
- (c) The electrical measurements for LA3 are considered to be non-destructive and therefore components so tested may form part of the delivery lot.
- (d) The solderability and terminal strength tests are considered to be destructive and therefore components so tested shall not form part of the delivery lot. Post-burn-in electrical rejects may be used for these tests.
- (e) When required in the purchase order, the Manufacturer shall notify the Orderer at least 2 working weeks before the commencement of LA3 testing. The Orderer shall indicate immediately whether or not he intends to witness the tests.

### 8.2.4 Lot Acceptance Level 2 Testing (LA2)

Lot acceptance level 2 testing shall comprise the tests for LA3 (electrical subgroup) plus tests on an endurance subgroup. For the electrical subgroup, the requirements and conditions as for LA3 (see Para. 8.2.3) shall apply.

For the endurance subgroup, the following shall apply:-

- (a) Components of testing level "C", selected for the endurance subgroup, shall be serialised prior to the tests.
- (b) The tests in this subgroup are considered to be destructive and therefore components (of testing level "B" or "C") so tested shall not form part of the delivery lot.

### 8.2.5 Lot Acceptance Level 1 Testing (LA1)

Lot acceptance level 1 testing shall comprise the tests for LA3 (electrical subgroup) and LA2 (endurance subgroup) plus tests on an environmental and mechanical subgroup. For the electrical and endurance subgroups, the requirements and conditions for LA3 (see Para. 8.2.3) and LA2 (see Para. 8.2.4) respectively shall apply.

For the environmental subgroup, the following shall apply:-

- (a) Components of testing level "C", selected for the environmental subgroup, shall be serialised prior to the tests.
- (b) The tests in this subgroup are considered to be destructive and therefore components (of testing level "B" or "C") so tested shall not form part of the delivery lot.

## 8.3 FAILURE CRITERIA

The following criteria shall apply to qualification testing and to lot acceptance testing.

### 8.3.1 Environmental and Mechanical Test Failures

The following shall be counted as component failures:

- Components which fail during tests for which the pass/fail criteria are inherent in the test method, e.g. solderability, vibration, terminal strength, resistance to soldering heat, etc.



### 8.3.2 Electrical Failures

The following shall be counted as component failures:-

- (a) Components which, when subjected to electrical measurements on completion of environmental tests, in accordance with either Table 2 or Table 6, as specified in the Detail Specification, fail one or more of the applicable limits.
- (b) Components which, when subjected to electrical measurements at intermediate and end-points during endurance testing, in accordance with Table 6 of the Detail Specification, fail one or more of the applicable limits.
- (c) Components which, when subjected to measurement of electrical characteristics, in accordance with Tables 2 and 3 of the Detail Specification, fail one or more of the applicable limits.

### 8.3.3 Other Failures

The following additional failures may also occur during qualification testing or lot acceptance testing:-

- (a) Components failing to comply with the requirements of ESA/SCC Basic Specification No. 20500.
- (b) Lost components.

### 8.4 FAILED COMPONENTS

A component shall be considered as failed if it exhibits one or more of the failure modes detailed in Para. 8.3 of this specification. The allowable number of failed components per Subgroup, the aggregate failure constraints and the permitted distribution of such failures are shown at the foot of Charts IV and V of this specification.

When requested by the Qualifying Space Agency or the Orderer, failure analysis of failed components shall be performed by the Manufacturer and the results provided.

Failed components from successful lots shall be marked as such and be stored at the Manufacturer's plant for 24 months.

### 8.5 LOT FAILURE

A lot shall be considered as failed if the allowable number of failures according to Chart IV or V of this specification, as relevant, has been exceeded.

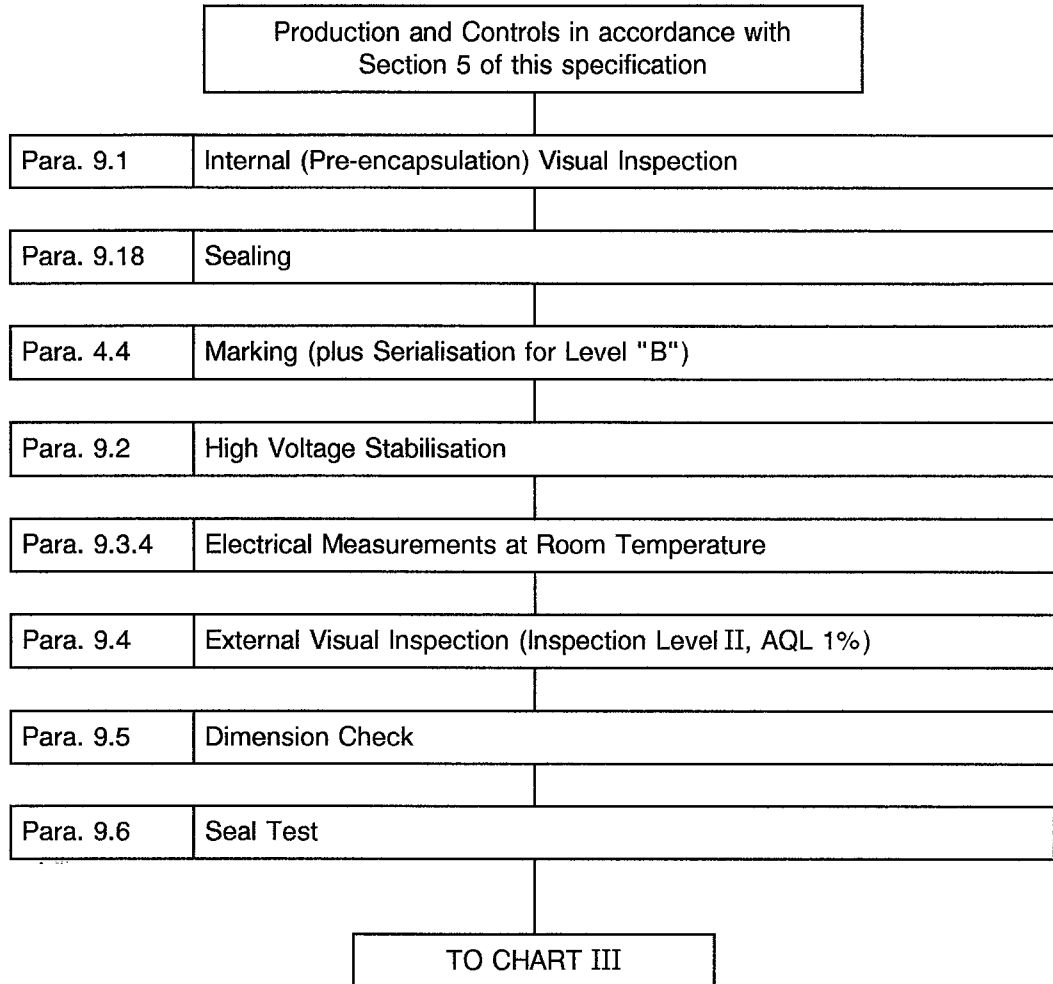
In the case of lot failure, the Manufacturer shall act in accordance with Para. 4.3.1 of this specification.

### 8.6 DOCUMENTATION

For qualification testing, the qualification test data shall be documented in accordance with the requirements of Para. 10.8 of this specification.

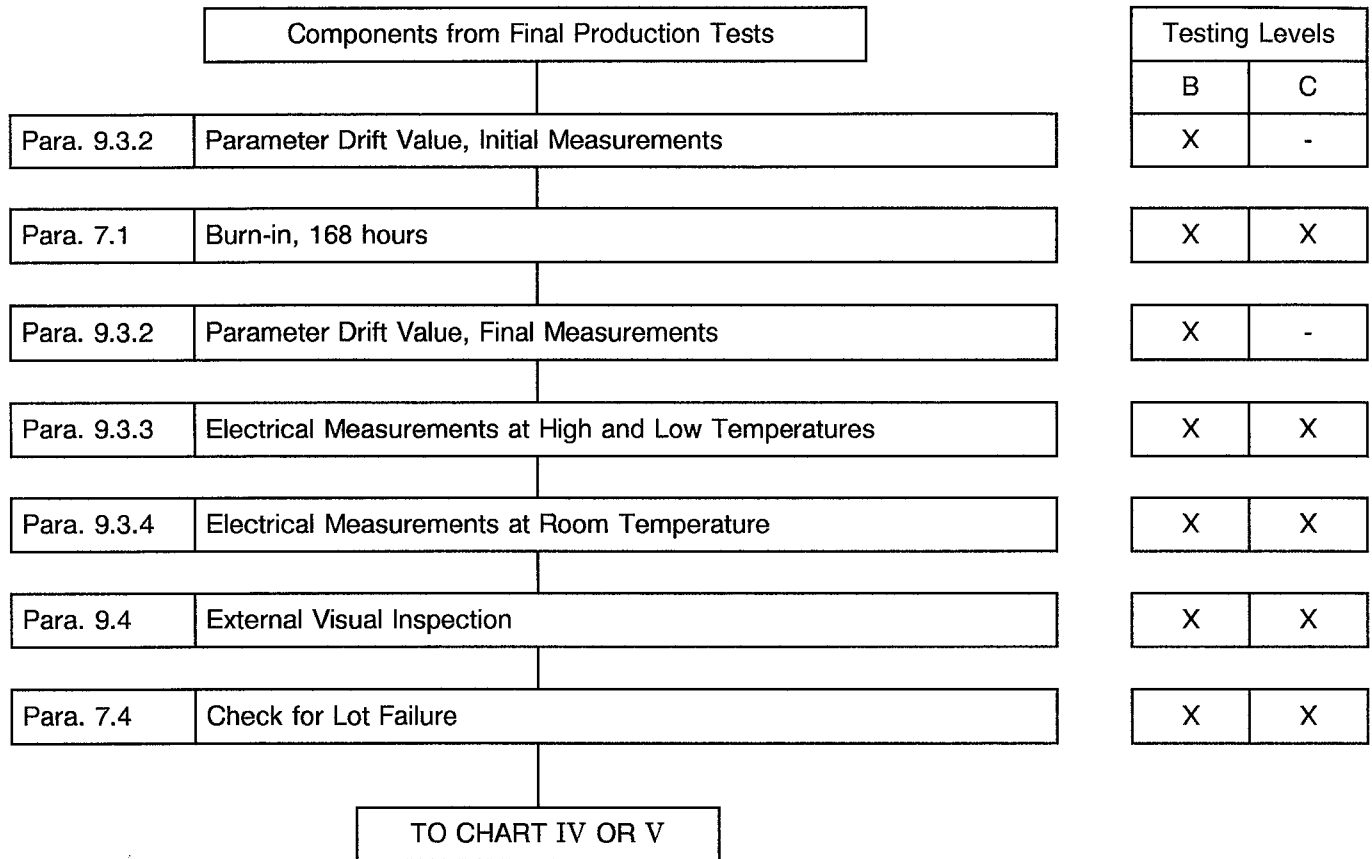
In the case of lot acceptance testing, the data shall be documented in accordance with the requirements of Para. 10.9 of this specification.



**CHART II - FINAL PRODUCTION TESTS**

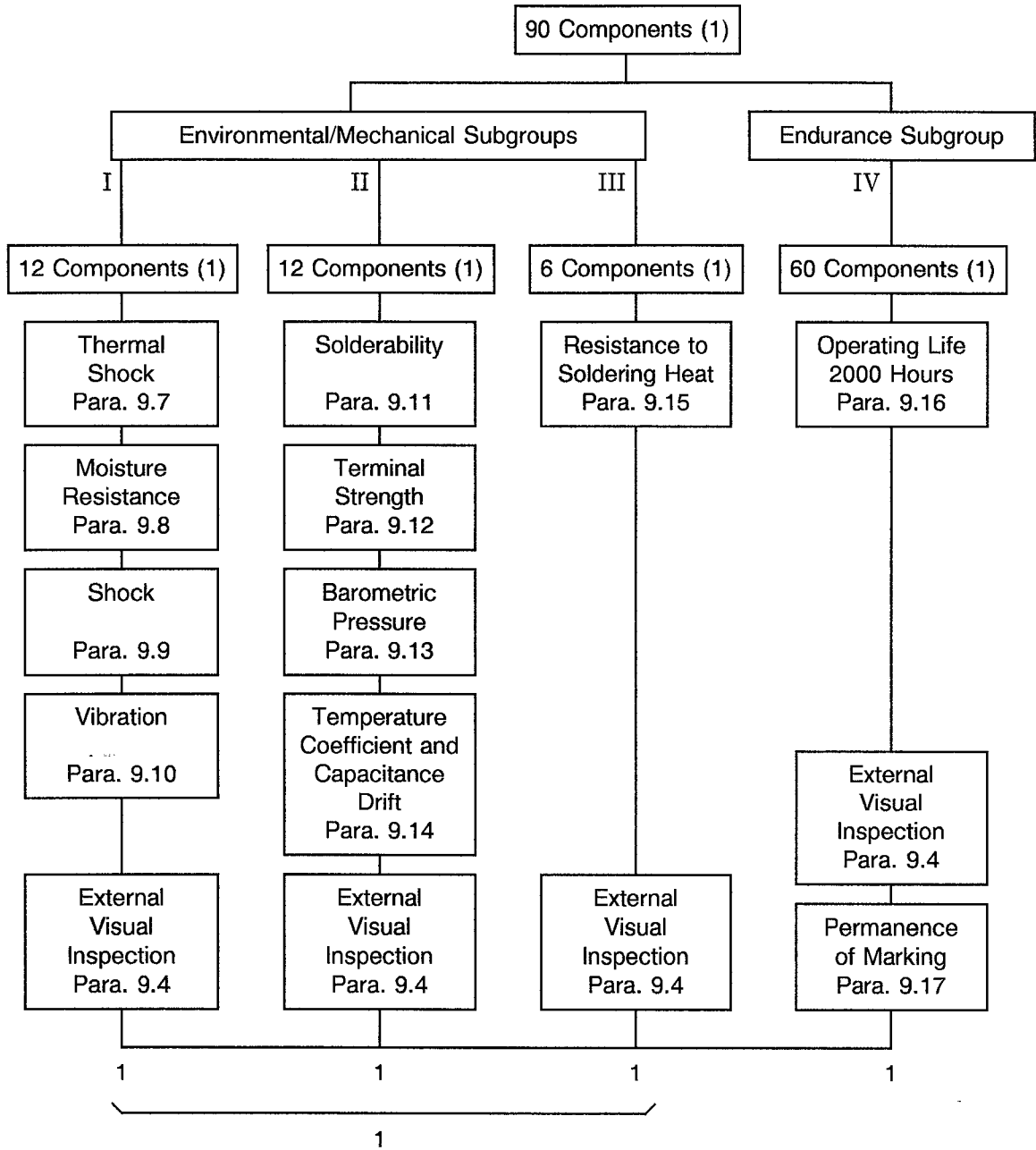


**CHART III - BURN-IN AND ELECTRICAL MEASUREMENTS**





**CHART IV - QUALIFICATION TESTS**



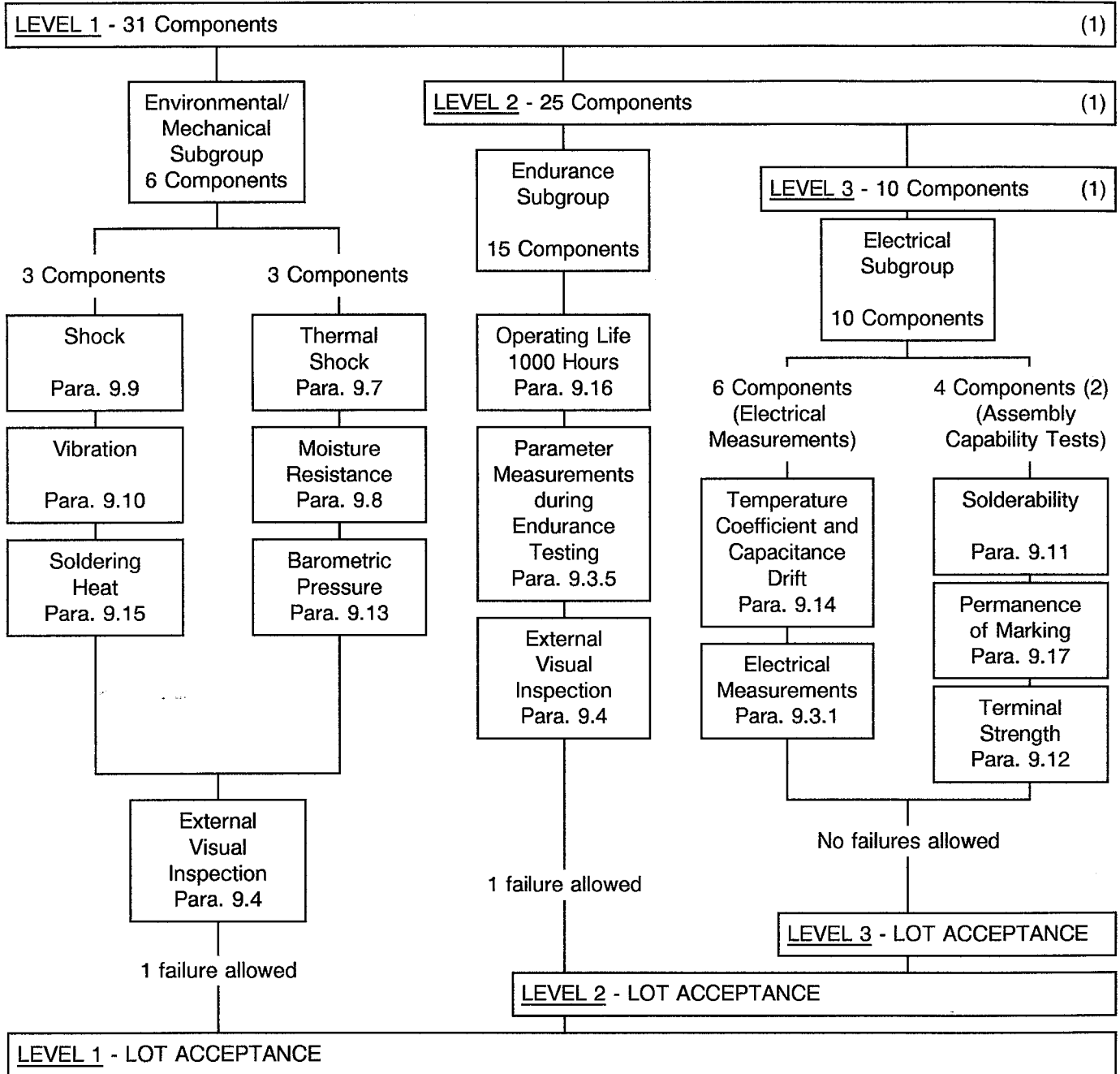
Total allowable number of failed components: 2.

**NOTES**

1. For distribution within the subgroups, see Para. 8.1.2.



**CHART V - LOT ACCEPTANCE TESTS**



**NOTES**

1. For distribution within the subgroups, see Para. 8.2.2.
2. Post burn-in electrical rejects may be used for this test.



9. **TEST METHODS AND PROCEDURES**

If a Manufacturer elects to eliminate or modify a test method or procedure, the Manufacturer is still responsible for delivering components that meet all of the performance, quality and reliability requirements defined in this specification and the Detail Specification.

Documentation supporting the change shall be approved by the Qualifying Space Agency and retained by the Manufacturer. It shall be copied, when requested, to the Qualifying Space Agency.

The change shall be specified in the Detail Specification and in the P.I.D.

9.1 **INTERNAL VISUAL INSPECTION**

See ESA/SCC Basic Specification No. 20400.

9.2 **HIGH VOLTAGE STABILISATION**

The capacitors shall be subjected to 4 times their rated voltage  $\pm 2.0\%$  with a maximum of 1 500V. The temperature shall be  $+22 \pm 3$  °C and the duration 50(+10-0) hours. During this test, the capacitors shall be adequately protected against temporary voltage surges of 10% or more of the test voltage. The capacitors shall be mounted in such a manner that no capacitor is within 25mm of any other capacitor. After the test, the capacitors shall show no damage, arcing or breakdown.

9.3 **ELECTRICAL MEASUREMENTS**

9.3.1 **General**

Unless otherwise specified in the Detail Specification, the following measurements shall be made under standard conditions in accordance with Table 2 of the Detail Specification.

9.3.1.1 **Capacitance**

The capacitance shall be measured at 1.0MHz  $\pm 50$ kHz when the normal capacitance is 1 000pF or less. 1.0kHz  $\pm 50$ Hz when the nominal capacitance is greater than 1 000pF.

The accuracy of the measuring equipment shall be such that the error does not exceed  $\pm 0.2\%$  of the rated capacitance value or  $\pm 0.2$ pF, whichever is the greater.

9.3.1.2 **Quality Factor**

The quality factor shall be measured under the same frequency conditions as those given in Para. 9.3.1.1 The measuring method shall be such that the error does not exceed  $\pm 2.0\%$  of the specified value or  $5 \cdot 10^{-4}$ , whichever is the greater.

9.3.1.3 **Insulation Resistance**

Before this measurement is made, the capacitors must be fully discharged. Unless otherwise specified, the insulation resistance shall be measured with the voltage specified below, from terminal to terminal.

RATED VOLTAGE (V)	MEASURING VOLTAGE (V)
$U_R \leq 100$	$10 \pm 1.0$
$100 \leq U_R \leq 500$	$100 \pm 15$
$U_R \geq 500$	$500 \pm 50$

$U_R$  is the rated voltage for use in defining the measuring voltage to be used under standard atmospheric conditions for testing.

The insulation resistance shall be measured after the voltage has been applied for 1.0 minute  $\pm 5.0$  seconds unless otherwise prescribed in the Detail Specification.

The internal resistance of the voltage source  $R_S$  shall be such that  $R_S C_R \leq 1.0$  second. The charging current shall not exceed 0.05A.



#### 9.3.1.4 Voltage Proof

200% of d.c. rated voltage shall be applied between terminations. Duration of application of test voltage shall not be less than 1.0 second, nor more than 5.0 seconds. The internal resistance of voltage source  $R_S$  shall be such that  $R_S C_R \leq 1.0$  second. The surge current shall not exceed 0.05A.

After the test, the capacitors shall be examined for evidence of damage, arcing or breakdown.

#### 9.3.2 Parameter Drift Value Measurements

At each of the relevant data points for components of testing level "B", measurements shall be made of all parameters listed in Table 4 of the Detail Specification. All values obtained shall be recorded against serial numbers and the parameter drift calculated.

#### 9.3.3 Electrical Measurements at High and Low Temperatures

For components of testing levels "B" and "C", the electrical measurements at high and low temperatures shall be made in accordance with Table 3 of the Detail Specification. Where sample testing is applied, note the requirements of Para. 8.2.3(b). For testing level "B", all values obtained shall be recorded against serial numbers.

If measurements shall be made by sampling, the Inspection Level shall be II (normal inspection according to MIL-STD-105).

#### 9.3.4 Electrical Measurements at Room Temperature

For components of testing levels "B" and "C", the measurements of electrical characteristics shall be made in accordance with Table 2 of the Detail Specification. Where sample testing is applied, note the requirements of Para. 8.2.3(b). For testing level "B", all values obtained shall be recorded against serial numbers.

#### 9.3.5 Parameter Measurements during Endurance Testing

At each of the relevant data points required for endurance testing, measurements shall be made of all parameters listed in Table 6 of the ESA/SCC Detail Specification. All values obtained shall be recorded against the serial number and the parameter drift calculated, if required.

#### 9.4 EXTERNAL VISUAL INSPECTION

See ESA/SCC Basic Specification No. 20500.

#### 9.5 DIMENSION CHECK

In accordance with ESA/SCC Basic Specification No. 20500 and the Detail Specification. To be performed on 5 samples only.

If 1 failure occurs, the complete lot shall be checked.

#### 9.6 SEAL TEST

The capacitors shall be tested in accordance with whichever of the following methods is applicable:-

##### (a) **Test I (for transparent cases):**

The capacitors shall be immersed in a fluorescent penetrant for 6.5 minutes and a pressure of 140kPa (20psi) shall be maintained for 3.0 minutes. On removal from the penetrant, the capacitors shall be cleaned, dried and inspected under ultraviolet light for penetration of dye.

**(b) Test II (for opaque cases):**

The capacitors shall be subjected to a saturated steam atmosphere of 35kPa (5.0psi) for 20 to 30 minutes. The insulation resistance shall be measured as specified in Para. 9.3.1.3 within 5 minutes of removal from steam atmosphere.

**9.7 THERMAL SHOCK**

The capacitors shall be tested in accordance with MIL-STD-202, Test Method 107. The following details shall apply:-

- (a) Test Condition: 'B'.
- (b) Measurements before and after cycling: Not applicable.

**9.8 MOISTURE RESISTANCE**

Following thermal shock, the capacitors shall be tested in accordance with MIL-STD-202, Test Method 106. The following details and exceptions shall apply:-

**(a) Mounting:**

The capacitors shall be mounted by their terminals in a manner that will keep the capacitor body from touching the test fixture. The capacitors shall be so spaced that the distance between the mounting support and the capacitor body is  $15 \pm 1.5$  mm.

**(b) Initial Measurements:**

Not applicable.

**(c) Number of Cycles:**

20 continuous cycles with steps 7a and 7b applicable to the first 10 cycles only.

**(d) Loading Voltage:**

A d.c. potential of 90 to 100V across the capacitor terminals shall be applied to the first 10 cycles. Once a day, a check shall be made to determine whether a capacitor has shorted.

**(e) Final Measurements:**

After the final cycle and between 1 and 4 hours after removal from the chamber, the insulation resistance shall be measured at ambient room conditions as specified in Para. 9.3.1.3. Artificial drying shall not be permitted. Between 4 and 24 hours after this measurement, the capacitors shall be visually examined for evidence of corrosion or mechanical damage. The capacitance, quality factor and voltage proof shall then be measured as specified in Para's 9.3.1.1, 9.3.1.2 and 9.3.1.4 respectively. They shall not exceed the limits prescribed in Table 6 of the Detail Specification.

**9.9 SHOCK**

The capacitors shall be tested in accordance with MIL-STD-202, Test Method 213. The following details shall apply:-

**(a) Mounting:**

The capacitors shall be rigidly mounted by the body to the test apparatus in such a manner that the mounting method does not damage them.

**(b) Test Condition:**

'1' (100G).

**(c) Measurements during Shock:**

During shock, an electrical measurement shall be made to determine intermittent contact or open- or short-circuiting. The accuracy of the detection equipment shall be sufficient to detect any interruption of 0.5ms or longer duration.

After the test, the capacitors shall be examined for evidence of arcing and mechanical damage.

**9.10 VIBRATION**

The capacitors shall be tested in accordance with MIL-STD-202, Test Method 204. The following details shall apply:-

**(a) Mounting:**

The capacitors shall be rigidly mounted by the body to the test apparatus in such a manner that the mounting method does not damage them.

**(b) Test Condition:**

'D' (20G).

**(c) Measurements during Vibration:**

During the last cycle in each direction, an electrical measurement shall be made to determine intermittent contact or open or short circuiting. The accuracy of the detection equipment shall be sufficient to detect any interruption of 0.5ms or longer duration.

**9.11 SOLDERABILITY**

The capacitors shall be tested in accordance with MIL-STD-202, Test Method 208. The following details shall apply:-

(a) Number of terminations to be tested of each capacitor: 2.

(b) Depth of immersion in flux and solder: Both terminals shall be immersed to within 1.25mm of the capacitor body.

When tested as specified, the dipped portion of the terminals shall conform to the solid wire termination criteria of MIL-STD-202, Test Method 208.

**9.12 TERMINAL STRENGTH**

The number of sample units shall be divided into 2 equal groups; a different group shall be used for each of the following tests.

**(a) Pull Test:**

The capacitors shall be tested in accordance with MIL-STD-202, Test Method 211. The following details and exceptions shall apply:-

(1) Test Condition: 'A'.

(2) Applied Force: 2.0 Newtons.

**(b) Bend Test:**

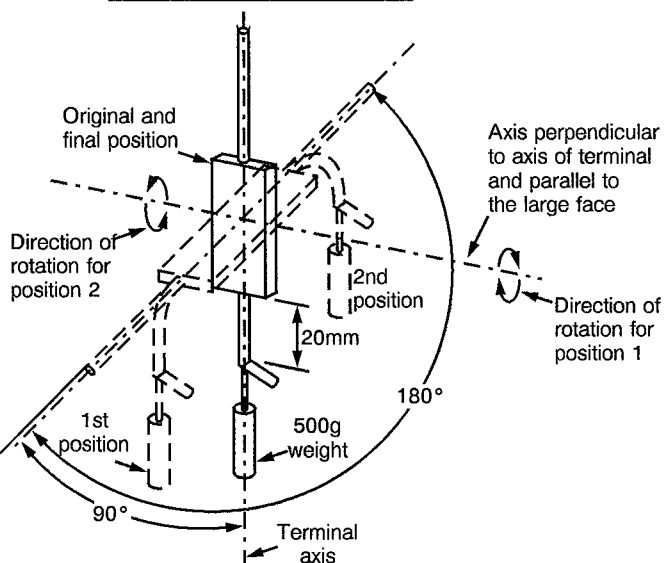
A weight of 0.5kg shall be hung from each terminal in turn at a point which is 20mm away from where the terminal protrudes from the capacitor body. The body shall be rotated about an axis which is perpendicular to the axis of the terminals and parallel to the largest surface through 90°, back through 180° and then returned to its original position (see Figure I).

After the test, the capacitors shall be visually examined for evidence of loosening or rupturing of the terminals, or damage to the terminals or seal.





FIGURE I - BEND TEST



9.13 BAROMETRIC PRESSURE

The capacitors shall be tested in accordance with MIL-STD-202, Test Method 105. The following details shall apply:-

- (a) Test Condition: 'D' (30 000m).
- (b) Tests during subjection to reduced pressure: 150% of rated voltage (Table 1(b) of the Detail Specification) shall be applied between the terminals for not less than 1.0 second, nor more than 5.0 seconds.

After the test, the capacitors shall be examined for evidence of damage, arcing and breakdown.

9.14 TEMPERATURE COEFFICIENT AND CAPACITANCE DRIFT

The capacitance shall be measured at the following temperatures at a frequency of 100kHz ± 10kHz:-

+25 ± 2 °C; -55(+0 -2) °C; +25 ± 2 °C; 125(+2 -0) °C; and +25 ± 2 °C respectively.

The reference frequency at which measurements are made shall not drift more than +50Hz during the test. An accuracy of ±0.025% of nominal capacitance +0.05pF shall be maintained for measurement of capacitance change. The measurement at each temperature shall be recorded when two successive readings, taken at 5 minute intervals at that temperature, indicate no change in capacitance. The temperatures at the time of measurement shall be measured with an accuracy of ±1.0% of the temperature difference between the nominal test temperature and the nominal reference temperature +0.5°C.

9.14.1 Temperature Coefficient

The temperature coefficient shall be computed as follows:-

$$TC = \frac{(C_2 - C_1) 10^6}{(T_2 - T_1) C_1}$$

where:-

- TC = Temperature Coefficient (in parts per million per °C).
- C<sub>1</sub> = Capacitance (in pF at the middle +25°C (reference temperature)).
- C<sub>2</sub> = Capacitance (in pF at test temperature).
- T<sub>1</sub> = +25°C.
- T<sub>2</sub> = Test temperature (°C).



The upper limit of temperature coefficient shall be as prescribed in Table 6 of the Detail Specification.

#### 9.14.2 Capacitance Drift

Capacitance drift shall be computed by dividing the greatest single difference between any 2 of the 3 values recorded at +25°C by the intermediate value recorded at +25°C. The capacitance change shall not exceed the limit prescribed in Table 6 of the Detail Specification.

#### 9.15 RESISTANCE TO SOLDERING HEAT

Capacitors shall be tested in accordance with MIL-STD-202, Test Method 210. The following details and exceptions shall apply:-

- (a) Depth of immersion in molten solder: To a minimum of 6.0mm from the capacitor body.
- (b) Test Condition: 'B' (+260 ± 5 °C).
- (c) Cooling time prior to measurement after test: 10 ± 1.0 minutes.
- (d) Measurement and examination after test: Capacitance, insulation resistance and quality factor shall be measured at +22 ± 3 °C as specified in Para's. 9.3.1.1, 9.3.1.2 and 9.3.1.3 respectively. The measurements shall conform to those shown in Table 6 of the Detail Specification.

#### 9.16 OPERATING LIFE

Capacitors shall be tested in accordance with MIL-STD-202, Test Method 108. The following details and exceptions shall apply:-

- (a) Distance of temperature measurements from specimens: No requirement.
- (b) Test Temperature: As prescribed in the Detail Specification.
- (c) Operating Conditions: The d.c. rated voltage prescribed in the Detail Specification shall be applied. The maximum surge current shall be not more than 50mA. A current-limiting resistor shall be inserted into the circuit.
- (d) Test Condition: 'F'.

The capacitors shall be subjected to an operating life test of 2000 hours for qualification or 1000 hours for lot acceptance levels 1 and 2 at the ambient temperature defined in the Detail Specification.



- (e) After approximately 1000, 2000 hours for qualification and 1000 hours for lot acceptance testing, measurement of capacitance, insulation resistance and quality factor at +22 ± 3 °C at the end of the test, as specified in Para's. 9.3.1.1, 9.3.1.2 and 9.3.1.3 respectively. The measurements shall conform to those shown in Table 6 of the Detail Specification.

#### 9.17 PERMANENCE OF MARKING

In accordance with ESA/SCC Basic Specification No. 24800

#### 9.18 SEALING

In accordance with the Process Identification Document (P.I.D.).

 	<p style="text-align: center;">ESA/SCC Generic Specification No. 3004</p>	<p style="text-align: center;">Rev. 'C'</p>	<p>PAGE 26 ISSUE 2</p>
---	---	---	----------------------------

**10. DATA DOCUMENTATION**

**10.1 GENERAL**

For the qualification approval records and with each component delivery, a data documentation package is required. Depending on the testing level and lot acceptance level specified for the component, this package shall be compiled from:-

- (a) Cover sheet (or sheets).
- (b) List of equipment (testing and measuring).
- (c) List of test references.
- (d) Special in-process control test data (when required by the Detail Specification).
- (e) Final production test data (Chart II) (but see Para. 10.6).
- (f) Burn-in and electrical measurement data (Chart III).
- (g) Qualification test data (Chart IV).
- (h) Lot acceptance test data (Chart V) (when applicable).
- (i) Failed component list (see Paras 7.3 and 8.4) and failure analysis report (see Para. 8.4).
- (j) Certificate of Conformity.

Items (a) to (j) inclusive shall be grouped, preferably as subpackages and, for identification purposes, each page shall include the following information:

- ESA/SCC Component Number.
- Manufacturer's name.
- Lot identification.
- Date of establishment of the document.
- Page number.

**10.1.1 Qualification Approval**


In the case of qualification approval, the items listed in Para. 10.1 (a) to (j) less item (h) are required.

**10.1.2 Testing Level "B"**

**10.1.2.1 Qualified Components**

For deliveries of qualified components, the following documentation shall be supplied:-

- (a) Cover sheet (if all of the information is not included on the Certificate of Conformity).
- (b) Certificate of Conformity (including range of delivered serial numbers).
- (c) Attributes record of measurements, tests and inspections performed in Chart II, Chart III (including PDA figure) and Chart V (where applicable).
- (d) Failed components list.

	<p style="text-align: center;">ESA/SCC Generic Specification No. 3004</p>	<p style="text-align: center;">Rev. 'C'</p>	<p>PAGE 26A ISSUE 2</p>
---	---	---	-----------------------------

#### 10.1.2.2 Unqualified Components

For deliveries of unqualified components, the documentation to be supplied shall be in accordance with Para. 10.1.2.1 plus the following:-

- (a) Read and record data from Chart III.
- (b) Special in-process control data (where applicable).
- (c) Failure analysis report on failed components.

#### 10.1.3 Testing Level "C"

##### 10.1.3.1 Qualified Components

For deliveries of qualified components, the following documentation shall be supplied:-

- (a) Certificate of Conformity.

##### 10.1.3.2 Unqualified Components

For deliveries of unqualified components, the documentation to be supplied shall be in accordance with Para. 10.1.3.1 plus the following:-

- (a) Cover sheet (if all of the information is not included on the Certificate of Conformity).
- (b) Attributes record of all measurements, tests and inspections performed in Charts II, III and V (when applicable).
- (c) Failed components list (including Failure Analysis Report).
- (d) Special in-process control data (when applicable).

#### 10.1.4 Data Retention/Data Access

If not delivered, all data shall be retained by the Manufacturer for a minimum of 5 years during which time it shall be available to the Qualifying Space Agency and the Orderer, if requested, for review. The Manufacturer shall deliver variables Data/Reports to the Orderer if required by the Purchase Order.

**10.2 COVER SHEET(S)**

The cover sheet(s) of the data documentation package shall include as a minimum:-

- (a) Reference to the Detail Specification, including issue and date.
- (b) Reference to the applicable ESA/SCC Generic Specification, including issue and date.
- (c) Component type and number.
- (d) Lot identification.
- (e) Range of delivered serial numbers (for components of testing level "B").
- (f) Number of purchase order.
- (g) Information relative to any additions to this specification and/or the Detail Specification.
- (h) Manufacturer's name and address.
- (j) Location of the manufacturing plant.
- (k) Signature on behalf of Manufacturer.
- (l) Total number of pages of the data package.

**10.3 LIST OF EQUIPMENT USED**

A list of equipment used for tests and measurements shall be prepared, if not in accordance with the data given in the Process Identification Document (P.I.D.). Where applicable, this list shall contain inventory number, Manufacturer's type number, serial number, etc. This list shall indicate for which tests such equipment was used.

**10.4 LIST OF TEST REFERENCES**

This list shall include all Manufacturer's references or codes which are necessary to correlate the test data provided with the applicable tests specified in the tables of the Detail Specification.

**10.5 SPECIAL IN-PROCESS CONTROL DATA**

As specified in the Detail Specification.

**10.6 FINAL PRODUCTION TEST DATA (CHART II)**

A test result summary shall be compiled showing the total number of components submitted to, and the total number rejected after, each of the following tests:

- High Voltage Stabilisation (Para. 9.2).
- Electrical measurements at room temperature (Para. 9.3.4).
- External visual inspection (Para. 9.4).
- Dimension check (Para. 9.5).
- Seal Test (Para. 9.6).

The final production test data shall form an integral part of the data documentation package, but it is not a mandatory requirement that it be delivered with the qualification lot or delivery lot. However, the data package to be delivered shall contain the information as detailed in Paras. 10.1.2 and 10.1.3 or at least shall contain a list of final production tests actually performed and a certification that the data is available for review.



## 10.7 BURN-IN AND ELECTRICAL MEASUREMENT DATA (CHART III)

### 10.7.1 Testing Level "B"

For components of testing level "B", all data shall refer to the relevant serial numbers. Against these serial numbers, data shall be recorded of the following:-

- (a) 0-hour measurement for burn-in.
- (b) 168-hour measurement for burn-in.
- (c) Delta values after burn-in.
- (d) Values obtained during measurements at high and low temperatures (Table 3 of the Detail Specification).
- (e) Values obtained during measurements of electrical characteristics (Table 2 of the Detail Specification).
- (f) Failures during external visual inspection.

### 10.7.2 Testing Level "C"

For components of testing level "C", a test result summary (i.e. the total number of components subjected to, and the total number rejected from, each of the tests and inspections) shall be prepared.

## 10.8 QUALIFICATION TEST DATA (CHART IV)

All data shall be referenced to the relevant serial numbers. Detailed records shall be provided of the components submitted to each test in each of the subgroups and of those rejected. Detailed data shall be provided of all electrical measurements made in accordance with Tables 2 and 6 of the Detail Specification, as and where applicable.

## 10.9 LOT ACCEPTANCE TEST DATA (CHART V)

### 10.9.1 Testing Level "B"

All data shall be referenced to the relevant serial numbers. Detailed records shall be provided of the components submitted to each test in each of the subgroups (as relevant to the lot acceptance level) and of those rejected.



Detailed data shall be provided of all electrical measurements made in accordance with Tables 2, 3 and 6 of the Detail Specification, as and where applicable.

### 10.9.2 Testing Level "C"

A test result summary (i.e. the total number of components submitted to, and and the total number rejected from, each of the tests and inspections) as relevant to the lot acceptance level shall be provided.

In the case of lot acceptance 2 testing, all data in respect of electrical measurements made in accordance with Table 6 of the Detail Specification shall be referenced to the relevant serial numbers (see Para. 8.2.4(a)).

In the case of lot acceptance 1 testing, all data in respect of electrical measurements made in accordance with Tables 2 and 6 of the Detail Specification shall be referenced to the relevant serial numbers (see Para. 8.2.5(a)).

		<p>ESA/SCC Generic Specification No. 3004</p>	<p>Rev. 'B'</p>	<p>PAGE 29 ISSUE 2</p>
--	---	---	-----------------	----------------------------

10.10 **FAILED COMPONENTS LIST AND FAILURE ANALYSIS REPORT**

The failed component list and failure analysis report shall provide full details of:-

- (a) The reference number and description of the test or measurement performed as defined in this specification and/or the Detail Specification.
- (b) The serial number (if applicable) of the failed component.
- (c) The failed parameter and the failure mode of the component.
- (d) Detailed failure analysis, if requested.

10.11 **CERTIFICATE OF CONFORMITY**

A Certificate of Conformity shall be established as defined in ESA/SCC Basic Specification No. 20100.

11. **DELIVERY**

For qualification approval, the disposition of the qualification test lot and its related documentation shall be as specified in ESA/SCC Basic Specification No. 20100 and the relevant paragraphs of Section 10 of this specification.

For procurement, for each order, the items forming the delivery are:-

- (a) The delivery lot.
- (b) The components used for lot acceptance testing, (when applicable), but not forming part of the delivery lot (see Para's 8.2.3(d), 8.2.4(b) and 8.2.5(b)).
- (c) The relevant documentation in accordance with the requirements of Section 10 of this specification.

In the case of a component for which a valid qualification approval is in force, all data of all components submitted to LA1 and LA2 testing shall also be copied, when requested, to the relevant Qualifying Space Agency.

12. **PACKAGING AND DESPATCH**

The packaging and despatch of components to this specification shall be in accordance with the requirements of ESA/SCC Basic Specification No. 20600.



**ANNEXE I**

**LTPD SAMPLING PLAN LOT SIZES GREATER THAN 200 DEVICES**


Minimum size of sample to be tested to assure with a 90% confidence that a lot whose Percent Defective equals the specified LTPD is not accepted (single sample).

Max. Percent Defective (LTPD) or $\lambda$	50	30	20	15	10	7	5	3	2	1.5	1	0.7	0.5	0.3	0.2	0.15	0.1
Acceptance Number (c) ( $r = c + 1$ )	MINIMUM SAMPLE SIZES (FOR DEVICE-HOURS REQUIRED FOR LIFE TEST, MULTIPLY BY 1000)																
0	5 (1.03)	8 (0.64)	11 (0.46)	15 (0.34)	22 (0.23)	32 (0.16)	45 (0.11)	76 (0.07)	116 (0.04)	153 (0.03)	231 (0.02)	328 (0.02)	461 (0.01)	767 (0.007)	1152 (0.005)	1534 (0.003)	2303 (0.002)
1	8 (4.4)	13 (2.7)	18 (2.0)	25 (1.4)	38 (0.94)	55 (0.65)	77 (0.46)	129 (0.28)	195 (0.18)	258 (0.14)	390 (0.09)	555 (0.06)	778 (0.045)	1296 (0.027)	1946 (0.018)	2592 (0.013)	3891 (0.009)
2	11 (7.4)	18 (4.5)	25 (3.4)	34 (2.24)	52 (1.6)	75 (1.1)	105 (0.78)	176 (0.47)	266 (0.31)	354 (0.23)	533 (0.15)	759 (0.11)	1065 (0.080)	1773 (0.045)	2662 (0.031)	3547 (0.022)	5323 (0.015)
3	13 (10.5)	22 (6.2)	32 (4.4)	43 (3.2)	65 (2.1)	94 (1.5)	132 (1.0)	221 (0.62)	333 (0.41)	444 (0.31)	668 (0.20)	953 (0.14)	1337 (0.10)	2226 (0.062)	3341 (0.041)	4452 (0.031)	6681 (0.018)
4	16 (12.3)	27 (7.3)	38 (5.3)	52 (3.9)	78 (2.6)	113 (1.8)	158 (1.3)	265 (0.75)	398 (0.50)	531 (0.37)	798 (0.25)	1140 (0.17)	1599 (0.12)	2663 (0.074)	3997 (0.049)	5327 (0.037)	7994 (0.025)
5	19 (13.8)	31 (8.4)	45 (6.0)	60 (4.4)	91 (2.9)	131 (2.0)	184 (1.4)	308 (0.85)	462 (0.57)	617 (0.42)	927 (0.28)	1323 (0.20)	1855 (0.14)	3090 (0.085)	4638 (0.056)	6181 (0.042)	9275 (0.028)
6	21 (15.6)	35 (9.4)	51 (6.6)	68 (4.9)	104 (3.2)	149 (2.2)	209 (1.6)	349 (0.94)	528 (0.62)	700 (0.47)	1054 (0.31)	1503 (0.22)	2107 (0.155)	3509 (0.093)	5267 (0.062)	7019 (0.047)	10533 (0.031)
7	24 (16.6)	39 (10.2)	57 (7.2)	77 (5.3)	116 (3.5)	166 (2.4)	234 (1.7)	390 (1.0)	589 (0.67)	783 (0.51)	1178 (0.34)	1680 (0.24)	2355 (0.17)	3922 (0.101)	5886 (0.067)	7845 (0.051)	11771 (0.034)
8	26 (18.1)	43 (10.9)	63 (7.7)	85 (5.6)	128 (3.7)	184 (2.6)	258 (1.8)	431 (1.1)	648 (0.72)	864 (0.54)	1300 (0.36)	1854 (0.25)	2599 (0.18)	4329 (0.108)	6498 (0.072)	8660 (0.054)	12995 (0.036)
9	28 (19.4)	47 (11.5)	69 (8.1)	93 (6.0)	140 (3.9)	201 (2.7)	282 (1.9)	471 (1.2)	709 (0.77)	945 (0.58)	1421 (0.38)	2027 (0.27)	2842 (0.19)	4733 (0.114)	7103 (0.077)	9468 (0.057)	14206 (0.038)
10	31 (19.9)	51 (12.1)	75 (8.4)	100 (6.3)	152 (4.1)	218 (2.9)	306 (2.0)	511 (1.2)	770 (0.80)	1025 (0.60)	1541 (0.40)	2199 (0.28)	3082 (0.20)	5133 (0.120)	7704 (0.080)	10268 (0.060)	15407 (0.040)
11	33 (21.0)	54 (12.8)	83 (8.3)	111 (6.2)	166 (4.2)	238 (2.9)	332 (2.1)	555 (1.2)	832 (0.83)	1109 (0.62)	1664 (0.42)	2378 (0.29)	3323 (0.21)	5546 (0.12)	8319 (0.083)	11092 (0.062)	16638 (0.042)
12	36 (21.4)	59 (13.0)	89 (8.6)	119 (6.5)	178 (4.3)	254 (3.0)	356 (2.2)	594 (1.3)	890 (0.86)	1187 (0.65)	1781 (0.43)	2544 (0.3)	3562 (0.22)	5936 (0.13)	8904 (0.086)	11872 (0.065)	17808 (0.043)
13	38 (22.3)	63 (13.4)	95 (8.9)	126 (6.7)	190 (4.5)	271 (3.1)	379 (2.26)	632 (1.3)	948 (0.89)	1264 (0.67)	1896 (0.44)	2709 (0.31)	3793 (0.22)	6321 (0.134)	9482 (0.089)	12643 (0.067)	18964 (0.045)
14	40 (23.1)	67 (13.8)	101 (9.2)	134 (6.9)	201 (4.6)	288 (3.2)	403 (2.3)	672 (1.4)	1007 (0.92)	1343 (0.69)	2015 (0.46)	2878 (0.32)	4029 (0.23)	6716 (0.138)	10073 (0.092)	13431 (0.069)	20146 (0.046)
15	43 (23.3)	71 (14.1)	107 (9.4)	142 (7.1)	213 (4.7)	305 (3.3)	426 (2.36)	711 (1.41)	1066 (0.94)	1422 (0.71)	2133 (0.47)	3046 (0.33)	4265 (0.235)	7108 (0.141)	10662 (0.094)	14216 (0.070)	21324 (0.047)
16	45 (24.1)	74 (14.0)	112 (9.7)	150 (7.2)	225 (4.8)	321 (3.37)	450 (2.41)	750 (1.44)	1124 (0.96)	1499 (0.72)	2249 (0.48)	3212 (0.337)	4497 (0.241)	7496 (0.144)	11244 (0.096)	14992 (0.072)	22487 (0.048)
17	47 (24.7)	79 (14.7)	118 (9.86)	158 (7.36)	236 (4.93)	338 (3.44)	473 (2.46)	788 (1.48)	1182 (0.98)	1576 (0.74)	2364 (0.49)	3377 (0.344)	4728 (0.246)	7880 (0.148)	11819 (0.098)	15759 (0.074)	23639 (0.049)
18	50 (24.9)	83 (15.0)	124 (10.0)	165 (7.54)	248 (5.02)	354 (3.51)	496 (2.51)	826 (1.51)	1239 (1.0)	1652 (0.75)	2478 (0.50)	3540 (0.351)	4956 (0.251)	8260 (0.151)	12390 (0.100)	16520 (0.075)	24780 (0.050)
19	52 (25.5)	86 (15.4)	130 (10.2)	173 (7.76)	259 (5.12)	370 (3.58)	518 (2.56)	864 (1.53)	1296 (1.02)	1728 (0.77)	2591 (0.52)	3702 (0.358)	5183 (0.256)	8638 (0.153)	12957 (0.102)	17276 (0.077)	25914 (0.051)
20	54 (26.1)	90 (15.6)	135 (10.4)	180 (7.82)	271 (5.19)	386 (3.65)	541 (2.60)	902 (1.56)	1353 (1.04)	1803 (0.78)	2705 (0.52)	3864 (0.364)	5410 (0.260)	9017 (0.156)	13526 (0.104)	18034 (0.078)	27051 (0.052)
26	65 (27.0)	109 (16.1)	163 (10.8)	217 (8.08)	326 (5.38)	466 (3.76)	652 (2.69)	1086 (1.61)	1629 (1.08)	2173 (0.807)	3259 (0.538)	4656 (0.376)	6518 (0.269)	10863 (0.161)	16295 (0.108)	21726 (0.081)	32589 (0.054)

- (1) Sample sizes are based upon the Poisson exponential binomial limit.
- (2) The minimum quality (approximate AQL) required to accept (on the average) 19 of 20 lots is shown in parentheses for information only.





	<b>SCC</b>	ESA/SCC Generic Specification No. 3004		PAGE 32 ISSUE 2
---	------------	---	--	--------------------

**ANNEXE I**

Page 3 of 3

This table gives the AQL and LTPD values associated with certain single sampling plans (Acceptance Number "C", Sample Size "n" and Lot Size "N"). The table has the following features:-

- (a) Calculations are based upon the hyper-geometric distribution (exact theory) for lot sizes of 200 devices or less.
- (b) The AQL of a sampling plan is defined as the interpolated Percent Defective for which there is a 0.95 probability of acceptance under the plan. The AQL so defined need not be a realisable Lot Percent Defective for the lot size involved (e.g., 12 percent is not a realisable Percent Defective for a lot size of 20 devices).
- (c) The LTPD of a sampling plan is defined as the interpolated Percent Defective for which there is a 0.10 probability of lot acceptance under the plan. The LTPD so defined need not be a realisable Lot Percent Defective for the lot size involved.
- (d) The sequence of sample sizes and lot sizes are generated by taking products of preceding numbers in the respective sequences and the numbers 2 and 5.