



europaean space agency
agence spatiale européenne

Pages 1 to 41

**CAPACITORS AND CAPACITOR FILTERS,
FEEDTHROUGH
ESA/SCC Generic Specification No. 3008**



**space components
coordination group**

Issue/Rev.	Date	Approved by	
		SCCG Chairman	ESA Director General or his Deputy
Issue 4	June 1997		
Revision 'A'	April 1999		

**DOCUMENTATION CHANGE NOTICE**

Rev. Letter	Rev. Date	Reference	CHANGE Item	Approved DCR No.
		This Issue supersedes Issue 3 and incorporates all modifications defined in Revisions 'A', 'B', 'C' and 'D' to Issue 3 and the changes agreed by the following DCR's which also complete the implementation of Policy DCR 21107:-		
		Cover page		None
		DCN		None
		Para. 4.1	: Second paragraph amended	23853
			: New paragraph added	23853
		Para. 4.1.3	: Second sentence amended	23853
		Para. 4.1.4	: Text amended	23853
		Chart I	: "(1)" added to Lot Acceptance Boxes and Note 1 added	23853
		Para. 8.2.1	: In the last paragraph, both sentences amended	23853
		Para. 8.2.3	: Text added to the beginning of (e)	23853
		Para. 8.4	: In the last paragraph, "either" and all after "months" deleted	23853
		Para. 9	: Text added	23853
		Para. 10.1	: "(when applicable)" added to (h)	23853
		Para. 10.1.2	: Existing text deleted and new text added	23853
		Para. 10.1.3	: Existing text deleted and new text added	23853
		Para. 10.1.4	: New paragraph added	23853
		Para. 10.2	: (e) amended	23853
		Para. 10.3	: First sentence amended	23853
		Para. 10.6	: In the second paragraph, second sentence amended	23853
			: Last paragraph deleted	23853
		Para. 10.7.1	: In the second sentence, "provided" replaced by "recorded"	23853
		Para. 10.7.2	: In the text, "provided" replaced by "prepared"	23853
		Para. 11	: In (b), "(when applicable)," added after "testing"	23853
			: In the last sentence, ", when requested," added after "copied"	23853
'A'	Apr. '99	P1. Cover Page		None
		P2. DCN		None
		P14. Para. 8.2.1	: New second sentence added to last paragraph	21111
		P34. Para. 10.1.2.1	: Item (b), "PDA figure and" deleted from text	21119
			: Item (c) rewritten	21119
		P35. Para. 10.1.3.1	: Item (a), "(including PDA figure)" deleted	21119

**TABLE OF CONTENTS**

	<u>Page</u>
1. <u>INTRODUCTION</u>	7
1.1 Scope	7
1.2 Applicability	7
2. <u>APPLICABLE DOCUMENTS</u>	7
2.1 ESA/SCC Specifications	7
2.2 Other (Reference) Documents	8
2.3 Order of Precedence	8
3. <u>TERMS, DEFINITIONS, ABBREVIATIONS, SYMBOLS AND UNITS</u>	8
4. <u>REQUIREMENTS</u>	8
4.1 General	8
4.1.1 Specifications	8
4.1.2 Conditions and Methods of Test	8
4.1.3 Manufacturer's Responsibility for Performance of Tests and Inspections	9
4.1.4 Inspection Rights	9
4.1.5 Pre-encapsulation Inspection	9
4.2 Qualification Approval Requirements on a Manufacturer	9
4.3 Deliverable Components	9
4.3.1 Lot Failure	9
4.3.2 Testing and Lot Acceptance Levels	10
4.4 Marking	10
4.5 Materials and Finishes	10
5. <u>PRODUCTION CONTROL</u>	10
5.1 General	10
5.2 Special In-process Controls	10
5.2.1 Supplementary Components	10
5.2.2 Documentation	10
6. <u>FINAL PRODUCTION TESTS</u>	12
6.1 General	12
6.2 Test Methods and Conditions	12
6.3 Documentation	12
7. <u>BURN-IN AND ELECTRICAL MEASUREMENTS</u>	12
7.1 General	12
7.1.1 Conditions of Test	12
7.1.2 Data Points	12
7.2 Failure Criteria	13
7.2.1 Parameter Drift Failure	13
7.2.2 Parameter Limit Failure	13
7.2.3 Other Failures	13
7.3 Failed Components	13
7.4 Lot Failure	13
7.4.1 Lot Failure during 100% Testing	13
7.4.2 Lot Failure during Sample Testing	13
7.5 Documentation	14



	<u>Page</u>
8. <u>QUALIFICATION APPROVAL AND LOT ACCEPTANCE TESTS</u>	14
8.1 Qualification Testing	14
8.1.1 General	14
8.1.2 Distribution within the Qualification Test Lot	14
8.2 Lot Acceptance Testing	14
8.2.1 General	14
8.2.2 Distribution within the Sample for Lot Acceptance Testing	15
8.2.3 Lot Acceptance Level 3 Testing	15
8.2.4 Lot Acceptance Level 2 Testing	15
8.2.5 Lot Acceptance Level 1 Testing	15
8.3 Failure Criteria	16
8.3.1 Environmental and Mechanical Test Failures	16
8.3.2 Electrical Failures	16
8.3.3 Other Failures	16
8.4 Failed Components	16
8.5 Lot Failure	16
8.6 Documentation	17
9. <u>TEST METHODS AND PROCEDURES</u>	22
9.1 Internal Visual Inspection	22
9.2 Rapid Change of Temperature	22
9.3 Vibration	22
9.4 Electrical Measurements	22
9.4.1 General	22
9.4.2 Parameter Drift Value Measurements	25
9.4.3 Electrical Measurements at High and Low Temperatures	25
9.4.4 Electrical Measurements at Room Temperature	25
9.4.5 Electrical Measurements during Endurance Testing	25
9.5 Dimension Check	25
9.6 Seal Test	25
9.6.1 Gross Leak	25
9.6.2 Fine Leak	25
9.7 External Visual Inspection	25
9.8 Radiographic Inspection	25
9.9 Temperature Rise	25
9.9.1 Mounting	26
9.9.2 Ambient Test Temperature	26
9.9.3 Operating Conditions	26
9.9.4 Measurements	26
9.9.5 Limit	26
9.10 Shock	26
9.10.1 Mounting	26
9.10.2 Procedure	27
9.10.3 Electrical Conditions	27
9.10.4 Final Examination and Measurements	27
9.11 Vibration	27
9.11.1 Mounting	27
9.11.2 Procedure	27
9.11.3 Electrical Conditions	28
9.11.4 Final Examination and Measurements	28



	<u>Page</u>
9.12 Accelerated Damp Heat	28
9.12.1 Mounting	28
9.12.2 Procedure	28
9.12.3 Final Examination and Measurements	28
9.13 Low Air Pressure	28
9.14 Robustness of Terminations	29
9.14.1 Mounting	29
9.14.2 Procedure	29
9.14.3 Final Examination and Measurements	29
9.15 Immersion	29
9.15.1 Mounting	29
9.15.2 Procedure	29
9.15.3 Final Examination and Measurements	30
9.16 Overload	30
9.17 Resistance to Soldering Heat	30
9.17.1 Procedure	30
9.17.2 Final Examination and Measurements	30
9.18 Solderability	30
9.18.1 Ageing	30
9.18.2 Procedure	30
9.18.3 Final Examination	31
9.19 Operating Life	31
9.19.1 Operating Life during Qualification Testing	31
9.19.2 Operating Life during Lot Acceptance Testing	32
9.20 Corrosion	32
9.21 Permanence of Marking	33
9.22 Final Assembly	33
9.23 Burn-in	33
9.24 Damp Heat	33
9.24.1 Mounting	33
9.24.2 Procedure	33
9.24.3 Electrical Conditions	33
9.24.4 Final Examination and Measurements	33
10. <u>DATA DOCUMENTATION</u>	34
10.1 General	34
10.1.1 Qualification Approval	34
10.1.2 Testing Level 'B'	34
10.1.3 Testing Level 'C'	35
10.1.4 Data Retention/Data Access	35
10.2 Cover Sheet(s)	35
10.3 List of Equipment Used	36
10.4 List of Test References	36
10.5 Special In-process Control Data	36
10.6 Final Production Test Data	36
10.7 Burn-in and Electrical Measurement Data	36
10.7.1 Testing Level 'B'	36
10.7.2 Testing Level 'C'	37
10.8 Qualification Test Data	37
10.9 Lot Acceptance Test Data	37
10.9.1 Testing Level 'B'	37
10.9.2 Testing Level 'C'	37
10.10 Failed Components List and Failure Analysis Report	37
10.11 Certificate of Conformity	37



	<u>Page</u>
11. <u>DELIVERY</u>	38
12. <u>PACKAGING AND DESPATCH</u>	38
<u>CHARTS</u>	
I TESTING LEVELS	11
II FINAL PRODUCTION TESTS	18
III BURN-IN AND ELECTRICAL MEASUREMENTS	19
IV QUALIFICATION TESTS	20
V LOT ACCEPTANCE TESTS	21
<u>FIGURES</u>	
I VOLTAGE DROP TEST CIRCUIT	24
<u>ANNEXES</u>	
I LTPD SAMPLING PLAN FOR LOT SIZES GREATER THAN 200 DEVICES	39
LTPD SAMPLING PLAN FOR LOT SIZES LESS THAN OR EQUAL TO 200 DEVICES	40

**SCC**

ESA/SCC Generic Specification

No. 3008

PAGE 7

ISSUE 4

1. INTRODUCTION

1.1 SCOPE

This specification defines the general requirements for the qualification approval, procurement, including lot acceptance testing, and delivery of Capacitors and Capacitor Filters, Feedthrough suitable for space application.

This specification contains the appropriate inspection and test schedules and also specifies the data documentation requirements.

1.2 APPLICABILITY

This specification is primarily applicable to the granting of qualification approval to a component in accordance with ESA/SCC Basic Specification No. 20100 and the procurement of such components from qualified Manufacturers.

2. APPLICABLE DOCUMENTS

The following documents form part of, and shall be read in conjunction with, this specification. The relevant issues shall be those in effect at the date of placing the purchase order.

2.1 ESA/SCC SPECIFICATIONS

No. 20100, Requirements for the Qualification of Standard Electronic Components for Space Application.

No. 20400, Internal Visual Inspection.

No. 20500, External Visual Inspection.

No. 20600, Preservation, Packaging and Despatch of SCC Electronic Components.

No. 20900, Radiographic Inspection.

No. 21300, Terms, Definitions, Abbreviations, Symbols and Units

No. 21700, General Requirements for the Marking of SCC Components.

No. 22800, ESA/SCC Non-conformance Control System.

No. 23500, Lead Materials and Finishes for Components for Space Application.

No. 24400, Measurement of Insertion Loss for EMI Suppression Filters.

No. 24600, Minimum Quality System Requirements.

No. 24800, Resistance to Solvents of Marking, Materials and Finishes

With the exception of ESA/SCC Basic Specification Nos. 20100, 21700, 22800 and 24600, where Manufacturers' specifications are equivalent to, or more stringent than, the ESA/SCC Basic Specifications listed above, they may be used in place of the latter, subject to the approval of the appropriate Qualifying Space Agency.

Such replacements will be clearly identified in the applicable Process Identification Document (P.I.D.) and listed in an appendix to the appropriate Detail Specification.

Unless otherwise stated herein, references within the text of this specification to "the Detail Specification" shall mean the relevant ESA/SCC Detail Specification.



2.2 OTHER (REFERENCE) DOCUMENTS

IEC Publication No. 68, Basic Environmental Testing Procedures.

IEC Publication No. 384, Fixed Capacitors for Use in Electronic Equipment.

IEC Publication No. 410, Sampling Plans and Procedures for Inspection by Attributes or, MIL-STD-105, Sampling Procedures and Tables for Inspection by Attributes.

MIL-STD-414, Sampling Procedures and Tables for Inspections by Variables for Percent Defective.

ESA PSS-01-702, A Thermal Vacuum Test for the Screening of Space Materials.

2.3 ORDER OF PRECEDENCE

For the purpose of interpretation and in case of conflict with regard to documentation, the following order of precedence shall apply:-

- (a) ESA/SCC Detail Specification.
- (b) ESA/SCC Generic Specification.
- (c) ESA/SCC Basic Specification.
- (d) Other documents, if referenced herein.

3. TERMS, DEFINITIONS, ABBREVIATIONS, SYMBOLS AND UNITS

The terms, definitions, abbreviations, symbols and units specified in ESA/SCC Basic Specification No. 21300 shall apply. In addition, the following terms are used:-

Hermetically sealed component: Component sealed at each end by a hermetic seal.

Non-hermetically sealed component: Component whose ends are strengthened by a sealing medium that is not considered hermetic.

4. REQUIREMENTS

4.1 GENERAL

The test requirements for qualification approval of a component shall comprise final production tests (see Chart II), burn-in and electrical measurements to testing level 'B' (see Chart III) and qualification testing (see Chart IV).

The test requirements for procurement of components shall comprise final production tests (Chart II), burn-in and electrical measurements to testing level 'B' or 'C' as required (Chart III) together with, when applicable, a level of lot acceptance testing (see Chart V) to be specified by the Orderer.

If a Manufacturer elects to eliminate a final production test by substituting an in-process control or statistical process control procedure, the Manufacturer is still responsible for delivering components that meet all of the performance, quality and reliability requirements defined in this specification and the Detail Specification.

4.1.1 Specifications

For qualification approval, procurement (including lot acceptance testing) and delivery of components in conformity with this specification, the specifications listed in Section 2 of this document shall apply in total unless otherwise specified herein or in the Detail Specification.

4.1.2 Conditions and Methods of Test

The conditions and methods of test shall be in accordance with this specification, the ESA/SCC Basic Specifications referenced herein and the Detail Specification.

**SCC**ESA/SCC Generic Specification
No. 3008

PAGE 9

ISSUE 4

4.1.3 Manufacturer's Responsibility for Performance of Tests and Inspections

The Manufacturer shall be responsible for the performance of tests and inspections required by the applicable specifications. These tests and inspections shall be performed at the plant of the Manufacturer of the components unless it is agreed by the Qualifying Space Agency, prior to commencing qualification testing, or procurement, to use an approved external facility.

4.1.4 Inspection Rights

The Qualifying Space Agency (for qualification approval or for a procurement) reserves the right to monitor any of the tests and inspections scheduled in the applicable specifications.

4.1.5 Pre-encapsulation Inspection

The Manufacturer shall notify the Orderer at least 2 working weeks before the commencement of pre-encapsulation inspection.

The Orderer shall indicate immediately whether or not he intends to witness the inspection.

4.2 QUALIFICATION APPROVAL REQUIREMENTS ON A MANUFACTURER

To obtain and maintain the qualification approval of a component, or family of components, a Manufacturer shall satisfy the requirements of ESA/SCC Basic Specification No. 20100.

4.3 DELIVERABLE COMPONENTS

Components delivered to this specification shall be processed and inspected in accordance with the relevant Process Identification Document (P.I.D.). Each delivered component shall be traceable to its production lot. Components delivered to this specification shall have completed satisfactorily all tests to the testing level and lot acceptance level specified in the purchase order (see Para. 4.3.2).

ESA/SCC qualified components delivered to this specification shall be produced from lots that are capable of passing all tests, and sequences of tests, that are defined in Charts IV and V. The Manufacturer shall not knowingly supply components that cannot meet this requirement. In the event that, subsequent to delivery and prior to operational use, a component is found to be in a condition such that it could not have passed these tests at the time of manufacture, this shall be grounds for rejection of the delivered lot.

Components failing inspections and tests of the higher testing level (i.e. level 'B') shall not be supplied against any order for components of the lower testing level.

4.3.1 Lot Failure

Lot failure may occur during final production tests (Chart II), burn-in and electrical measurements (Chart III), qualification testing (Chart IV) or lot acceptance testing (Chart V).

Should such failure occur, the non-conformance procedure shall be initiated in accordance with ESA/SCC Basic Specification No. 22800.

Should such failure occur during procurement, the Manufacturer shall notify the Orderer by telex within 2 working days, giving details of the number and mode of failure and the suspected cause.

In the case where qualification approval has been granted to the component, he shall, at the same time by the same means, inform the Qualifying Space Agency in order that the latter may consider its implications.

No further testing shall be performed on the failed components except on instructions from the Orderer. The Orderer shall inform the Manufacturer and the Qualifying Space Agency within 2 working days of receipt of the telex, by the same means what action shall be taken.

In the case where lot failure occurs during qualification testing, the Manufacturer shall immediately notify the appropriate Qualifying Space Agency who will define a course of action to be followed. No further testing shall be performed on the failed components.



4.3.2 Testing and Lot Acceptance Levels

This specification defines 2 levels of testing severity which are designated by the letters 'B' and 'C' (see Chart I) and 3 levels of lot acceptance testing (see Chart V).

The Lot Acceptance levels are designated 1, 2 and 3 and are comprised of tests as follows:-

Level 3 (LA3) - Electrical Subgroup.

Level 2 (LA2) - Endurance Subgroups
plus Electrical Subgroup.

Level 1 (LA1) - Environmental and Mechanical Subgroup
plus Endurance Subgroup
plus Electrical Subgroup.

The required testing level and lot acceptance level shall both be specified in a purchase order.

4.4 MARKING

All components procured and delivered to this specification from a source qualified according to ESA/SCC Basic Specification No. 20100 shall be marked in accordance with ESA/SCC Basic Specification No. 21700. Thus, they shall bear the ESA symbol to signify their conformance to the ESA/SCC qualification approval requirements and full compliance with the requirements of this specification and the Detail Specification.

Components procured from sources which are not ESA/SCC qualified, provided that they fully comply with the procurement requirements of this specification and the Detail Specification, may bear the SCC marking **with the exception of the ESA symbol.**

4.5 MATERIALS AND FINISHES

All non-metallic materials and finishes, that are not within a hermetically sealed enclosure, of the components specified herein shall meet the outgassing requirements as outlined in ESA PSS-01-702.

Specific requirements for materials and finishes are specified in the Detail Specification.

5. PRODUCTION CONTROL

5.1 GENERAL

The minimum requirements for production control, which are equally applicable to procurement, are defined in ESA/SCC Basic Specification No. 20100 Paras. 5.1 and 5.2.

5.2 SPECIAL IN-PROCESS CONTROLS

Where applicable, special in-process controls shall apply as specified in the Detail Specification.

5.2.1 Supplementary Components

Supplementary components shall, wherever possible, be obtained from ESA/SCC qualified sources. Procurement controls for supplementary components shall be agreed with the appropriate Qualifying Space Agency and form part of the P.I.D.

5.2.2 Documentation

Documentation of special in-process controls shall be in accordance with the requirements of Para. 10.5 of this specification.



CHART I - TESTING LEVELS

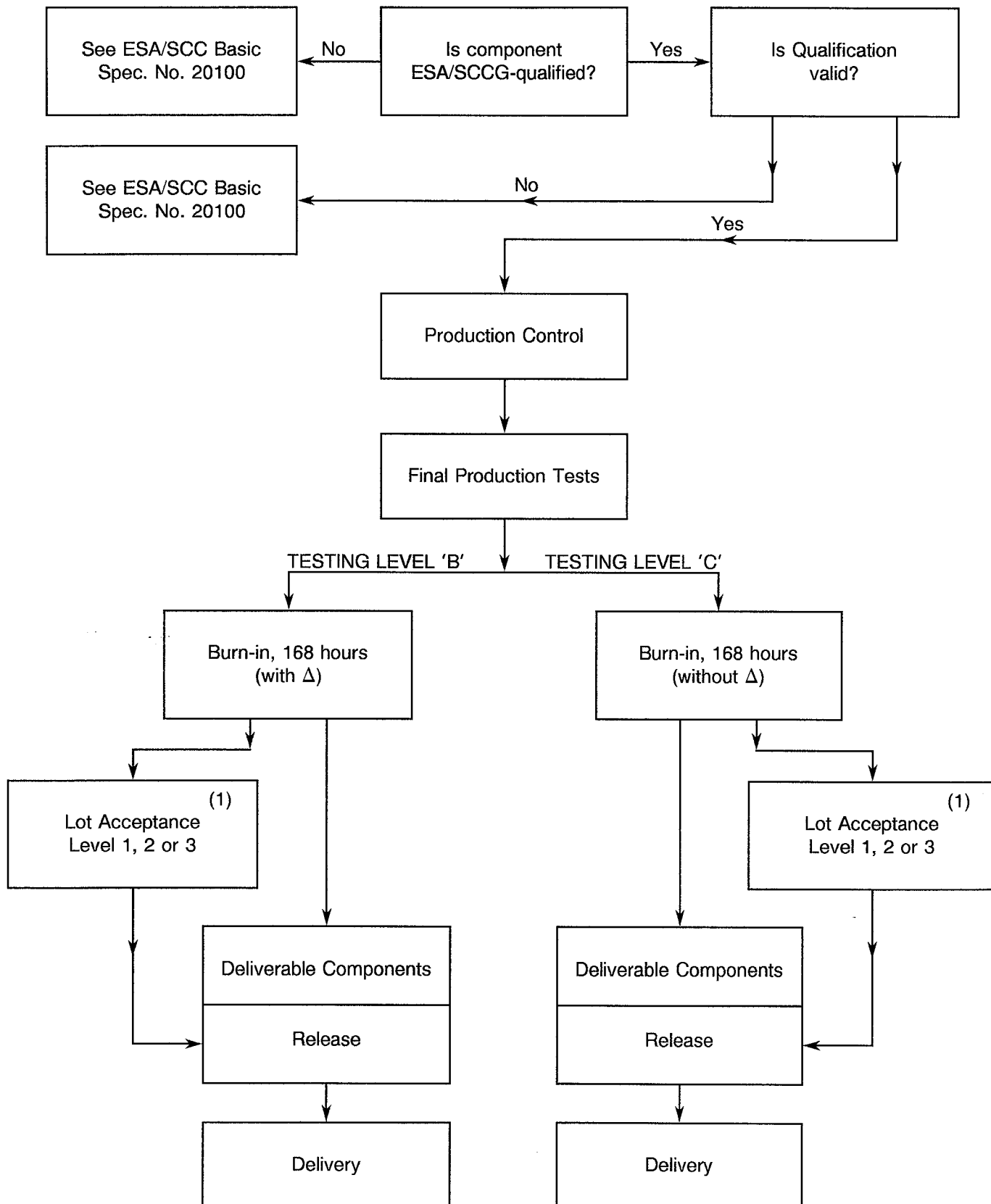

NOTES

1. When applicable.

**6. FINAL PRODUCTION TESTS****6.1 GENERAL**

Unless otherwise specified in the Detail Specification, all components used for qualification testing and all components for delivery, including those submitted to lot acceptance tests, shall be subjected to tests and inspections in accordance with Chart II.

Unless otherwise specified in the Detail Specification, the tests shall be performed in the order shown.

Any components that do not meet these requirements shall be removed from the lot and at no future time be resubmitted to the requirements of this specification.

6.2 TEST METHODS AND CONDITIONS

The applicable test methods and conditions are specified in the paragraphs referenced in Chart II of this specification.

6.3 DOCUMENTATION

Documentation of final production test data shall be in accordance with the requirements of Para. 10.6 of this specification.

7. BURN-IN AND ELECTRICAL MEASUREMENTS**7.1 GENERAL**

Unless otherwise specified in the Detail Specification, all components used for qualification testing and all components for delivery, including those submitted to lot acceptance tests, shall be subjected to tests and inspections in accordance with Chart III.

Unless otherwise specified in the Detail Specification, the tests shall be performed in the order shown.

The applicable test methods and conditions are specified in the paragraphs referenced in Chart III.

Components of testing level 'B' shall be serialised prior to the tests and inspections.

7.1.1 Conditions of Test

The conditions for burn-in shall be as shown in Table 5 of the Detail Specification.

Unless otherwise specified in the Detail Specification, components of both levels 'B' and 'C' shall be subjected to a total burn-in period of 168 hours. For the applicable test methods and procedures, see Para. 9.23.

7.1.2 Data Points

For components of testing level 'B', undergoing a total burn-in period of 168 hours, the data points for parameter drift measurement shall be 0 hours (initial) and 168(+24-0) hours (final).

For components of testing level 'C', undergoing a total burn-in period of 168 hours, the data point for Post Burn-in Electrical Measurements shall be 168(+24-0) hours.



7.2 FAILURE CRITERIA

7.2.1 Parameter Drift Failure

The acceptable delta limits are shown in Table 4 of the Detail Specification. A component of testing level 'B' shall be counted as a parameter drift failure if the changes during burn-in are larger than the delta (Δ) values specified.

7.2.2 Parameter Limit Failure

A component shall be counted as a limit failure if one or more parameters exceed the limits shown in Tables 2 or 3 of the Detail Specification.

Any component shall exhibits a limit failure prior to the burn-in sequence shall be rejected and not counted when determining lot rejection.

7.2.3 Other Failures

A component shall be counted as a failure in any of the following cases:

- Mechanical failure.
- Handling failure.
- Lost component.

7.3 FAILED COMPONENTS

A component shall be considered as a failed component if it exhibits one or more of the failure modes described in Para. 7.2 of this specification.

7.4 LOT FAILURE

In the case of lot failure, the Manufacturer shall act in accordance with the requirements of Para. 4.3.1 of this specification.

7.4.1 Lot Failure During 100% Testing

If the number of components failed on the basis of the failure criteria defined in Para. 7.2 exceeds 5% (rounded upwards to the nearest whole number) of the number of components submitted to burn-in and electrical measurements for electrical failures (Paras. 7.2.1 and 7.2.2) and/or 5% for other failures (Para. 7.2.3), the lot shall be considered as failed.

Components rejected for plating discolouration after burn-in shall not be considered for lot failure.



If a lot is composed of groups of components of one family defined in one ESA/SCC Detail Specification, but separately identifiable for any reason, then the lot failure criteria shall apply separately to each identifiable group.

7.4.2 Lot Failure During Sample Testing

A lot shall be considered as failed if the number of allowable failures during sample testing, in accordance with General Inspection Level II of IEC Publication No. 410 or MIL-STD-105 and the applicable AQL as specified in the Detail Specification, is exceeded.

In the case where an LPTD is specified in the Detail Specification, a lot shall be considered as failed if the number of failures allowed is exceeded (see Annexe I for LTPD Sampling Plan).

If lot failure occurs in either case, a 100% testing may be performed with the lot failure criteria given in Para. 7.4.1.

 	<p style="text-align: center;">ESA/SCC Generic Specification No. 3008</p>	<p style="text-align: center;">Rev. 'A'</p>	<p>PAGE 14 ISSUE 4</p>
---	---	---	----------------------------

7.5 DOCUMENTATION

Data documentation of burn-in and electrical measurements shall be in accordance with Para. 10.7 of this specification.

8. QUALIFICATION APPROVAL AND LOT ACCEPTANCE TESTS

8.1 QUALIFICATION TESTING

8.1.1 General

Qualification testing shall be in accordance with the requirements of Chart IV of this specification. The tests to Chart IV shall be performed on the specified sample, chosen at random from components which have successfully passed the tests in Charts II and III for testing level 'B'. This sample constitutes the qualification test lot.

The qualification test lot is divided into subgroups of tests and all components assigned to a subgroup shall be subjected to all of the tests in that subgroup, in the sequence shown.

The applicable test requirements are detailed in the paragraphs referenced in Chart IV.

The conditions governing qualification testing are given in ESA/SCC Basic Specification No. 20100, Para. 5.3 and, for the extension or renewal of a qualification approval, in Paras. 6.3 and 6.4.

8.1.2 Distribution within the Qualification Test Lot

A minimum sample of 100 components shall be submitted to qualification testing (Chart IV). The sample shall consist of test vehicles having the lowest and the highest voltages/currents. Of each of these voltage/current combinations, the highest capacitance value and, for that value, the tightest tolerance, shall be chosen. Thus, for the qualification approval of a series, testing is required on either 2, 3, 4 or more test vehicles. Where a series comprises 4 or more test vehicles, the minimum quantity of components per test vehicle must be:-

Subgroup 1 - 3 components.

Subgroup 2 - 3 components.

Subgroup 3 - 3 components.

Subgroup 4 - 16 components.

Where a series comprises less than 4 test vehicles, the sample shall be evenly distributed between the test vehicles.

The selected distribution shall be agreed with the Qualifying Space Agency.

8.2 LOT ACCEPTANCE TESTING

8.2.1 General

The sample sizes of the 3 lot acceptance levels are specified in Chart V. All components assigned to a subgroup shall be subjected to all of the tests of that subgroup in the sequence shown.

The tests to Chart V shall be performed on the specified sample which shall have been chosen, whenever possible, at random from the proposed delivery lot (but see Para. 8.2.3(b)). The applicable test requirements are detailed in the paragraphs referenced in Chart V.

As a minimum for procurement of non-qualified components, lot acceptance level 3 tests shall apply. For procurement of qualified components, lot acceptance testing shall be performed if specified in a purchase order. Procurement lots ordered with a lot acceptance test level shall be delivered only after successful completion of lot acceptance testing.



8.2.2 Distribution within the Sample for Lot Acceptance Testing

Where a Detail Specification covers a range or series of components that are considered similar, then it may be necessary that the sample for lot acceptance testing be comprised of component types so selected that they adequately represent all of the various mechanical, structural and electrical peculiarities of that range or series.

The distribution of the component types will normally vary from procurement to procurement and shall be specified by the Orderer, following as closely as possible the requirements prescribed in Para. 8.1.2 of this specification.

8.2.3 Lot Acceptance Level 3 Testing (LA3)

Lot acceptance level 3 tests are designated as the electrical subgroup and comprise electrical measurements of characteristics and tests to prove the assembly capability of the component. For LA3 testing, the following requirements and conditions shall apply:-

- (a) LA3 testing shall be performed by the Manufacturer's quality assurance personnel using dedicated quality assurance equipment whenever possible. LA3 testing shall not be a repetition of routine measurements made by production personnel during final production tests and burn-in and electrical measurements.
- (b) When tests to Tables 2 and 3 of the Detail Specification have been performed on a sample basis, then the components for LA3 testing shall be selected from this sample.
- (c) The electrical measurements for LA3 are considered to be non-destructive and therefore components so tested may form part of the delivery lot.
- (d) The solderability and robustness of termination tests are considered to be destructive and therefore components so tested shall not form part of the delivery lot. Post burn-in electrical rejects may be used for these tests.
- (e) When required in the purchase order, the Manufacturer shall notify the Orderer at least 2 working weeks before the commencement of LA3 testing. The Orderer shall indicate immediately whether or not he intends to witness the tests.

8.2.4 Lot Acceptance Level 2 Testing (LA2)

Lot acceptance level 2 testing shall comprise the tests for LA3 (electrical subgroup) plus tests on an endurance subgroup. For the electrical subgroup, the requirements and conditions as for LA3 (see Para. 8.2.3) shall apply.

For the endurance subgroup, the following shall apply:-

- (a) Components of testing level 'C', selected for the endurance subgroup, shall be serialised prior to the tests.
- (b) The tests in this subgroup are considered to be destructive and therefore components (of testing level 'B' or 'C') so tested shall not form part of the delivery lot.

8.2.5 Lot Acceptance Level 1 Testing (LA1)

Lot acceptance level 1 testing shall comprise the tests for LA3 (electrical subgroup) and LA2 (endurance subgroup) plus tests on an environmental and mechanical subgroup. For the electrical and endurance subgroups, the requirements and conditions for LA3 (see Para. 8.2.3) and LA2 (see Para. 8.2.4) respectively shall apply.



For the environmental subgroup, the following shall apply:-

- (a) Components of testing level 'C', selected for the environmental subgroup, shall be serialised prior to the tests.
- (b) The tests in this subgroup are considered to be destructive and therefore components (of testing level 'B' or 'C') so tested shall not form part of the delivery lot.

8.3 FAILURE CRITERIA

The following criteria shall apply to qualification testing and to lot acceptance testing.

8.3.1 Environmental and Mechanical Test Failures

The following shall be counted as component failures:

- Components which fail during tests for which the pass/fail criteria are inherent in the test method, e.g. seal, solderability, robustness of terminations etc.

8.3.2 Electrical Failures

The following shall be counted as component failures:-

- (a) Components which, when subjected to electrical measurement on completion of environmental tests, in accordance with either Table 2 or Table 6, as specified in the Detail Specification, fail one or more of the applicable limits.
- (b) Components which, when subjected to electrical measurements at intermediate and end-points during endurance testing, in accordance with Table 6 of the Detail Specification, fail one or more of the applicable limits.
- (c) Components which, when subjected to measurement of electrical characteristics, in accordance with Tables 2 and 3 of the Detail Specification, fail one or more of the applicable limits.

8.3.3 Other Failures

The following additional failures may also occur during qualification testing or lot acceptance testing:-

- (a) Component failing to comply with the requirements of ESA/SCC Basic Specification No. 20500.
- (b) Lost components.

8.4 FAILED COMPONENTS

A component shall be considered as failed if it exhibits one or more of the failure modes detailed in Para. 8.3 of this specification. The allowable number of failed components per subgroup, the aggregate failure constraints and the permitted distribution of such failures are shown at the foot of Charts IV and V of this specification.

When requested by the Qualifying Space Agency or the Orderer, failure analysis of failed components shall be performed by the Manufacturer and the results provided.

Failed components from successful lots shall be marked as such and be stored at the Manufacturer's plant for 24 months.

8.5 LOT FAILURE

A lot shall be considered as failed if the allowable number of failures according to Chart IV or V of this specification, as relevant, has been exceeded.

In the case of lot failure, the Manufacturer shall act in accordance with Para. 4.3.1 of this specification.

 SCC	ESA/SCC Generic Specification No. 3008		PAGE 17 ISSUE 4
--	---	--	--------------------

8.6 DOCUMENTATION

For qualification testing, the qualification test data shall be documented in accordance with the requirements of Para. 10.8 of this specification.

In the case of lot acceptance testing, the data shall be documented in accordance with the requirements of Para. 10.9 of this specification.



CHART II - FINAL PRODUCTION TESTS

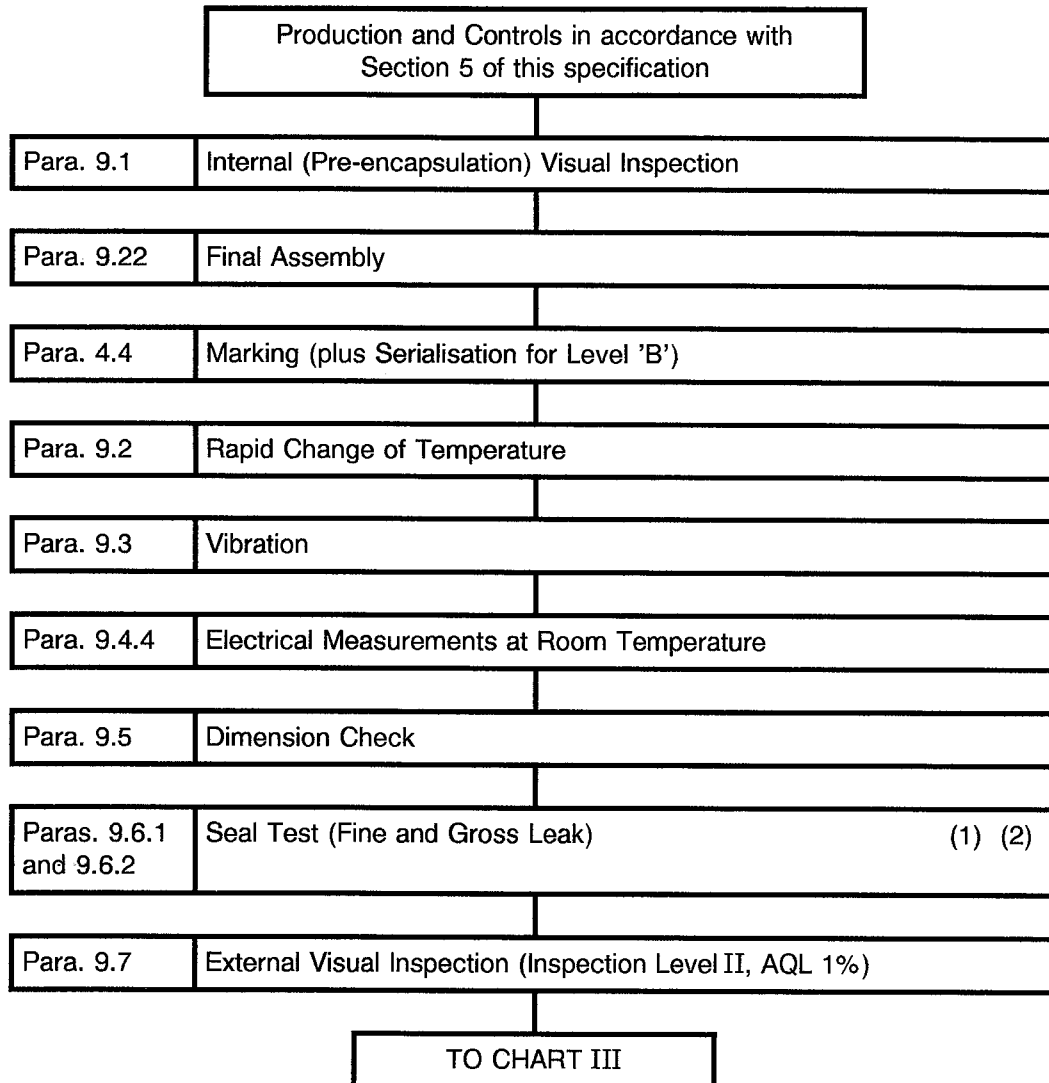

NOTES

1. The seal test may be performed at the Manufacturer's discretion.
2. For hermetically sealed components only.



CHART III - BURN-IN AND ELECTRICAL MEASUREMENTS

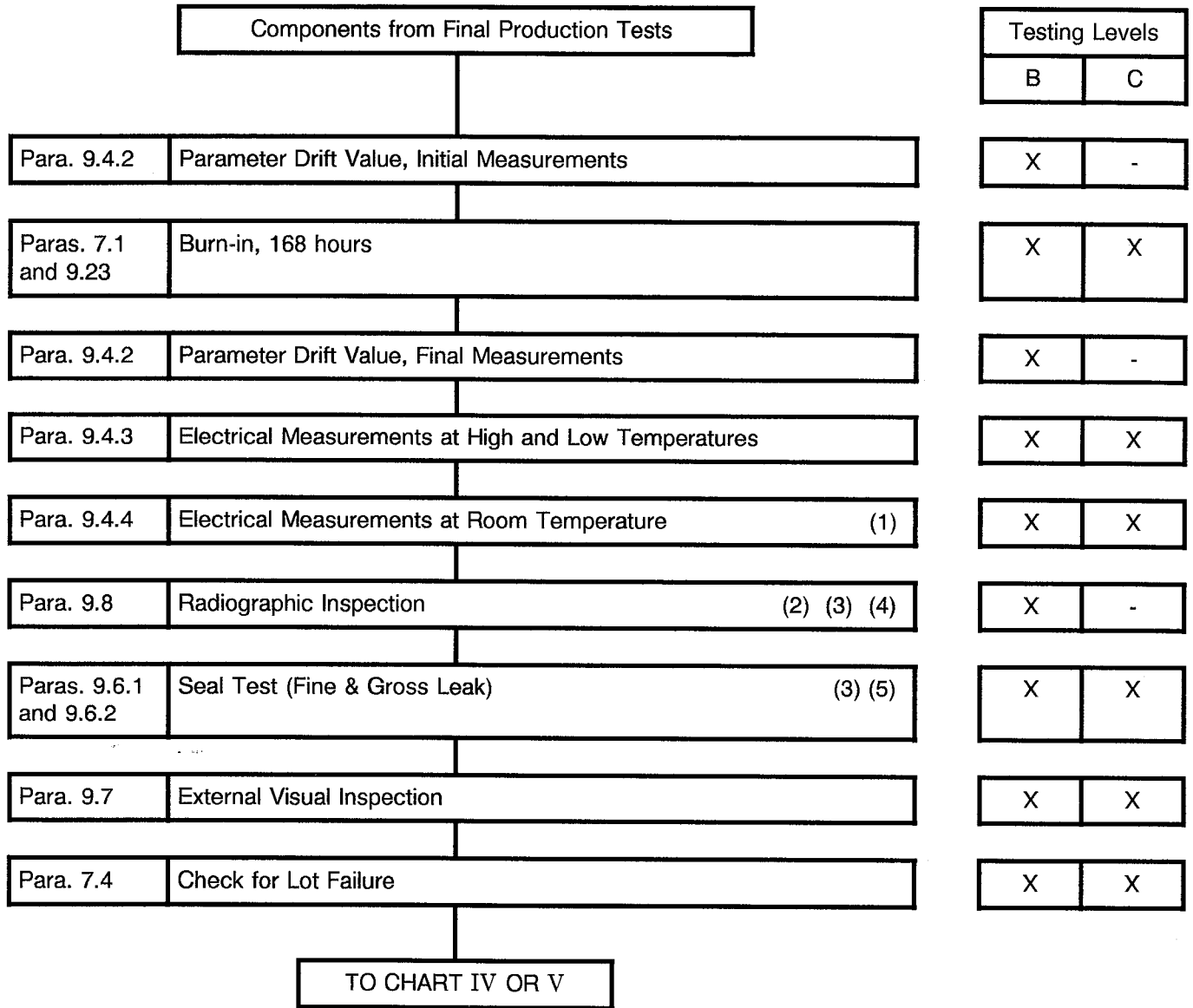

NOTES

1. The measurements of parameters for the purpose of drift value measurements need not be repeated for electrical measurements at room temperature.
2. Radiographic inspection may be performed at any point during the test sequence shown in this Chart.
3. Radiographic inspection and seal test rejects not to be counted for lot failure.
4. Unless otherwise specified in the Detail Specification.
5. For hermetically sealed components only.



CHART IV - QUALIFICATION TESTS

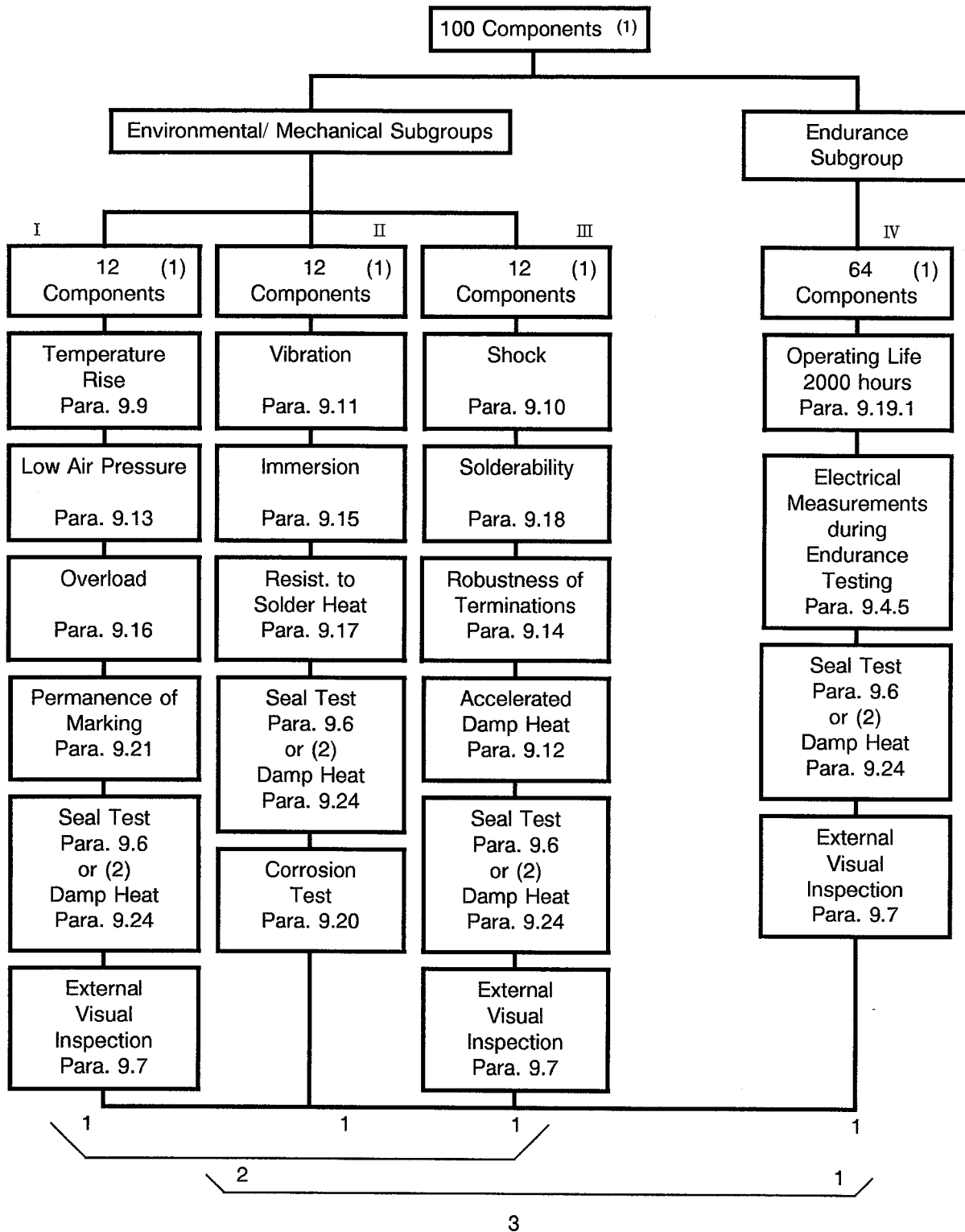

Total allowable number of failed components: 3.

NOTES

1. For distribution within the subgroups, see Para. 8.1.2.
2. Seal test for hermetically sealed components, damp heat for others.



CHART V - LOT ACCEPTANCE TESTS

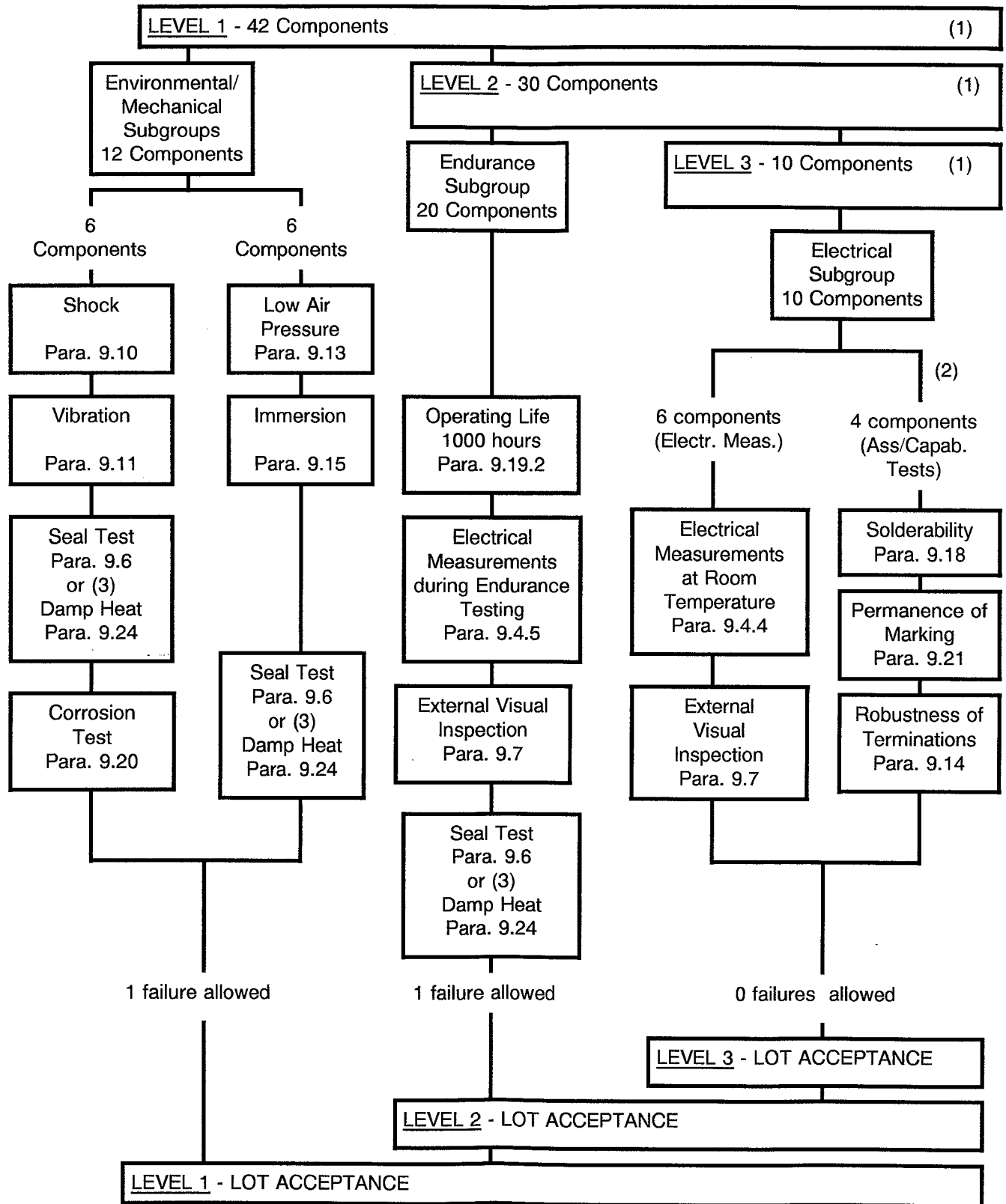

NOTES

1. For distribution within the subgroups, see Para. 8.2.2.
2. Post-burn-in electrical rejects may be used for this test.
3. Seal test for hermetically sealed components, damp heat for others.



9. TEST METHODS AND PROCEDURES

If a Manufacturer elects to eliminate or modify a test method or procedure, the Manufacturer is still responsible for delivering components that meet all of the performance, quality and reliability requirements defined in this specification and the Detail Specification.

Documentation supporting the change shall be approved by the Qualifying Space Agency and retained by the Manufacturer. It shall be copied, when requested, to the Qualifying Space Agency.

The change shall be specified in the Detail Specification and in the P.I.D.

9.1 INTERNAL VISUAL INSPECTION

In accordance with ESA/SCC Basic Specification No. 20400.

9.2 RAPID CHANGE OF TEMPERATURE

Components shall be mounted by their normal mounting means and, where applicable, to the torque rating defined in the Detail Specification. The components shall be subjected to Test 'Na' of IEC Publication No. 68-2-14 and for each cycle, the duration of exposure at each temperature extreme shall be 30 minutes. The components shall withstand the extremes of high and low temperature without visible damage:

- For final production tests (Chart II), the number of cycles shall be 5 and the temperature extremes shall be the operating temperature range as specified in the Detail Specification.
- For qualification and lot acceptance tests (Charts IV and V), the number of cycles shall be 10 and the temperature extremes shall be the storage temperature range as specified in the Detail Specification.

9.3 VIBRATION

Components shall be subjected to vibration testing in accordance with Para. 9.11 except that the sweep range shall be 100 to 2000 Hz, with a sweep time of 10 minutes through one pass of the frequency spectrum and shall be applied in the plane considered most vulnerable.

If the centre terminal is a continuous conductor, without internal joints, the open-circuit check (Para. 9.11.3) shall not be performed.

9.4 ELECTRICAL MEASUREMENTS

9.4.1 General

Electrical measurements and methods shall be as follows.

9.4.1.1 Capacitance

Capacitance shall be measured with a capacitance bridge or other suitable method. Unless otherwise specified in the Detail Specification, the following conditions shall apply:

- Test frequency: 1000 ± 100 Hz.
- Measurement voltage: 0.1 to 1.2 volts rms.

The accuracy of the measuring equipment shall be such that the error does not exceed:

- For absolute capacitance measurements: 10% of the rated capacitance tolerance.
- For measurement of variation in capacitance: 10% of the specified change in capacitance.

Temperature variation due to handling shall be avoided.

N.B.

Following a voltage proof or insulation resistance test, the capacitance measurement may be delayed for a period of up to 24 hours.



9.4.1.2 Voltage Proof

Components shall be tested in accordance with IEC Publication No. 384-1, Para. 4.6. The measuring points shall be between terminals connected together and the case.

For dc rated components the test voltage shall be 2.5 x the rated dc voltage defined in Table 1(b) of the Detail Specification. For ac rated components the test voltage shall be 2.8 x the rated rms ac voltage at the defined frequency.

The test voltage shall be applied for a period of 1 minute between the test points. The internal resistance of the voltage source R_S shall be such that $R_S C_R < 1s$.

The resistance of the voltmeter shall not be less than 20 000 Ohms/V. The resistances R_1 and R_2 shall be chosen such that, in conjunction with the capacitance C_1 and the capacitance of the part under test, the charging and discharging currents shall not exceed the following values:

- For $C \leq 1000pF$, $I_c = 50\mu A/pF$.
- For $C > 1000pF$, $I_c = 0.05A$.

There shall be no visible or electrical sign of breakdown or flash-over during the test period and, after completion of the test, the components shall be further visually examined for evidence of damage, arcing or breakdown.

9.4.1.3 Insulation Resistance

Components shall be tested in accordance with IEC Publication No. 384-1, Para. 4.5. Measurement accuracy shall be 10% from one hundredth of the limit value to 10^5 Mohms.

The internal resistance of the voltage source R_S shall be such that $R_S C_R < 1$ second. The charging current shall not exceed $50\mu A/pF$ for $C \leq 1000pF$ or $0.05A$ for $C > 1000pF$.

Measurements shall be made carefully to prevent damage to the component seal. If components fail this test due to ambient relative humidity in excess of 50%, they may be re-tested at any relative humidity from 20 to 50%. Intermediate and end-point measurements during Operating Life test (Para. 9.19) shall also be conducted at the elevated temperature.

Insulation-Resistance Correction Factors			
°C	Correction Factor	°C	Correction Factor
20	1.42	28	0.82
21	1.33	29	0.76
22	1.24	30	0.71
23	1.16	31	0.67
24	1.08	32	0.63
25	1.00	33	0.59
26	0.94	34	0.55
27	0.87	35	0.51



9.4.1.4 Insertion Loss

All measurements shall be made in accordance with ESA/SCC Basic Specification No. 24400.

At room temperature and with zero load current, an uncertainty of measurement of less than $\pm 3\text{dB}$ shall be achieved. At room temperature and with rated current, an uncertainty of measurement of less than $\pm 4\text{dB}$ shall be achieved.

For measurement at other than room temperature the same test circuit shall be employed but, to accommodate the temperature chamber, cables of not more than 600mm length with PTFE or equivalent dielectric may be interposed between each buffer network and the device under test.

During testing to Charts II, III and V, measurements shall be made at a minimum of three test frequencies which shall be defined in the Detail Specification. These frequencies shall be selected to include both the pass and stop bands. Unless otherwise specified in the Detail Specification, the load current shall be zero.

During testing to Chart IV, measurements shall be made at a minimum of five test frequencies which shall be defined in the Detail Specification. These frequencies shall be selected to include both the pass and stop bands. Unless otherwise specified in the Detail Specification, measurements shall be made with a load current of zero and, in addition, for one subgroup of 12 components, with rated current.

9.4.1.5 Voltage Drop

The test circuit shall be arranged as given in Figure I below. The components shall be energised with the rated current as defined in the Detail Specification.

For ac rated components, true rms reading instruments shall be employed with the test circuit operating at the maximum rated frequency.

Measurement shall be made across the components terminals and shall comply with the requirements of Table 1(b) of the Detail Specification.

FIGURE I - VOLTAGE DROP TEST CIRCUIT

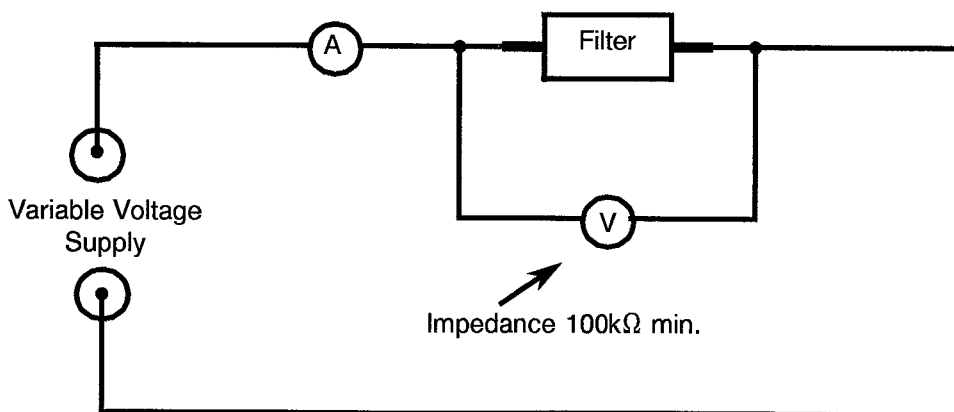



9.4.2 Parameter Drift Value Measurements

At each of the relevant data points for components of testing level 'B', measurements shall be made of all parameters listed in Table 4 of the Detail Specification. All values obtained shall be recorded against serial numbers and the parameter drift calculated.

9.4.3 Electrical Measurements at High and Low Temperatures

For components of testing levels 'B' and 'C', the electrical measurements at high and low temperatures shall be made in accordance with Table 3 of the Detail Specification. Where sample testing is applied, note the requirements of Para. 8.2.3(b). For testing level 'B', all values obtained shall be recorded against serial numbers.

9.4.4 Electrical Measurements at Room Temperature

For components of testing levels 'B' and 'C', the measurement of electrical characteristics shall be made in accordance with Table 2 of the Detail Specification. Where sample testing is applied, note the requirements of Para. 8.2.3(b). For testing level 'B', all values obtained shall be recorded against serial numbers.

9.4.5 Electrical Measurements during Endurance Testing

At each of the relevant data points required for endurance testing, measurements shall be made of all parameters listed in Table 6 of the Detail Specification. All values obtained shall be recorded against serial numbers and the parameter drift calculated, if required.

9.5 DIMENSION CHECK

In accordance with ESA/SCC Basic Specification No. 20500 and the Detail Specification. To be performed on 5 samples per case size only.

If 1 failure occurs, the complete lot shall be checked.

9.6 SEAL TEST (FOR HERMETICALLY SEALED DEVICES)

9.6.1 Gross Leak

The components shall be subjected to Test 'Qc' of IEC Publication No. 68-2-17, Method 2, using an inert fluorocarbon test liquid at $+125 \pm 2$ °C. There shall be no evidence of repetitive bubbling.

9.6.2 Fine Leak

The components shall be subjected to Test 'Qk' of IEC Publication No. 68-2-17, Method 1, Severity 1000 hours. Unless otherwise stated in the Detail Specification, immersion pressure shall not exceed 4 bars.

9.7 EXTERNAL VISUAL INSPECTION

In accordance with ESA/SCC Basic Specification No. 20500.

9.8 RADIOGRAPHIC INSPECTION

In accordance with ESA/SCC Basic Specification No. 20900.

9.9 TEMPERATURE RISE

The temperature rise of the components shall be determined by the following procedure.



9.9.1 Mounting

The components shall be suspended by their terminals during the test. They shall be separated from each other by a distance of not less than 25mm. During the test, radiant shields may be placed between units, so that overheating of one unit will not affect a nearby unit. Lead wires shall be of copper, 150mm long and of the size specified hereunder.

Rated Current of Filter (Amp)	Wire Size	
	AWG	Dia. (mm)
Up to 3	24	0.64
3+ to 5	22	0.85
5+ to 11	20	1.04
11+ to 16	18	1.29
16+ to 22	16	1.53
22+ to 32	14	1.87

9.9.2 Ambient Test Temperature

The test shall be conducted at room temperature without forced-air ventilation or any means of component cooling.

9.9.3 Operating Conditions

The components shall be energised with the rated dc current defined in Table 1(b) of the Detail Specification.

9.9.4 Measurements

After thermal stability has been reached and while the component is still energised, the maximum hot-spot on the component case shall be determined by the use of thermocouples.

The temperature rise (ΔT) shall be calculated by the following formula: $\Delta T = T - t$.

Where:

- T = Temperature in °C of the component under test.
- t = Ambient temperature in °C.

9.9.5 Limit

Unless otherwise specified in the Detail Specification, the temperature rise shall not exceed 25°C.

9.10 SHOCK

9.10.1 Mounting

The component shall be mechanically connected to the test apparatus, either directly or by means of a fixture as specified below. Mounting fixtures shall be such as to enable the component to be tested along 3 mutually perpendicular axes in turn, which should be chosen so that faults are most likely to be revealed.



Components shall be mounted by their normal mounting means and, where applicable, to the torque rating defined in the Detail Specification. Additional restraining straps should be avoided.

Unless otherwise specified, components not provided with specific mounting means shall be clamped on both body and leads (leads shall be clamped at 6 ± 1 mm from the body). Care should be taken to avoid pinching the leads.

External connections, necessary for measuring and supply purposes, should add the minimum restraint and mass.

9.10.2 Procedure

The components shall be subjected to Test 'Ea' of IEC Publication No. 68-2-27. Unless otherwise prescribed in the Detail Specification, the following conditions shall be applicable:

- Shape of the shock pulse : Half sine.
- Peak acceleration : 100g.
- Duration of the pulse : 6ms.
- Number of shocks : 18 (3 shocks in each of the 2 directions along the 3 mutually perpendicular axes of the test specimen).

9.10.3 Electrical Conditions

During the test, a potential of 100% of rated voltage, as defined in the Detail Specification, shall be applied between terminals and case. Detection equipment shall be employed that is capable of registering intermittent short circuits between terminals and case, or open circuits between terminals, of duration greater than 0.1ms.

9.10.4 Final Examination and Measurements

The components shall be examined and there shall be no evidence of mechanical damage. The Insertion Loss shall be measured and shall meet the requirements of Table 6 of the Detail Specification.

9.11 VIBRATION

9.11.1 Mounting

See Para. 9.10.1.

9.11.2 Procedure

The components shall be subjected to Test 'Fc' of IEC Publication No. 68-2-6.

Sweep frequency: 10 to 2000 Hz.

The entire frequency range of 10 to 2000 Hz and return to 10 Hz shall be traversed logarithmically in 20 minutes. This cycle shall be performed 6 times in each of the 3 directions (a total of 18 times), so that the motion shall be applied for a total period of approximately 6 hours.

Vibration amplitude shall be 0.75mm double amplitude or 20g (peak), whichever gives the lower acceleration.



9.11.3 Electrical Conditions

Unless otherwise specified in the Detail Specification, the components shall be energised with rated current and a potential of 100% of rated voltage shall be applied between terminals and case. For dc rated devices, where the centre terminal is a continuous conductor without internal joints, the current applied may be limited to that required for monitoring purposes.

During the last cycle in each direction, detection equipment shall be employed that is capable of registering intermittent short circuits between terminals and case, or open circuits between terminals, of duration greater than 0.1ms.

9.11.4 Final Examination and Measurements

The components shall be visually examined and there shall be no evidence of mechanical damage. Insertion Loss shall be measured and shall meet the requirements of Table 6 of the Detail Specification.

9.12 ACCELERATED DAMP HEAT

Before starting this test, the components shall be subjected to 10 cycles of the tests defined in Para. 9.2. No measurements shall be made before or after cycling.

9.12.1 Mounting

Components shall be mounted by their normal mounting means and, where applicable, to the torque rating defined in the Detail Specification.

9.12.2 Procedure

The components shall be subjected to Test 'Db' of IEC Publication No. 68-2-30 for 10 cycles of 24 hours at an upper temperature of +65°C. A potential of 100V or U_R , whichever is less, shall be applied during the cycling.

9.12.3 Final Examination and Measurements

After not less than 4, or more than 24 hours, the components shall be visually examined for evidence of corrosion or obliteration of markings. A Voltage Proof test at 90% of rated voltage, Insulation Resistance test and Insertion Loss measurements shall be made and shall comply with the requirements of Table 6 of the Detail Specification.

9.13 LOW AIR PRESSURE

The components shall be subjected to Test 'M' of IEC Publication No. 68-2-13 with the following conditions:

- Pressure: 40 mbar.
- Duration: 1 hour.
- Temperature: +15 to +35 °C.

While still at the specified low pressure and during the last 5 minutes of the 1 hour period, a voltage proof test shall be performed using 125% of rated voltage (Table 1(b) of the Detail Specification). During and after this test, there shall be no sign of permanent breakdown, flashover, harmful deformation of the case or seepage of impregnant.

**9.14 ROBUSTNESS OF TERMINATIONS**

The components shall be subjected to Tests 'Ua₁', 'Ub', 'Uc', as applicable, of IEC Publication No. 68-2-21.

N.B.

Tests 'Ub' and 'Uc' shall not be conducted if the Detail Specification describes the terminations as 'Rigid'.

9.14.1 Mounting

Components shall be mounted by their normal mounting means and, where applicable, to the torque rating defined in the Detail Specification.

9.14.2 Procedure**Test 'Ua₁', Tensile (All types of termination)**

For wire terminations, the loading force shall be as defined in Table 1 of IEC Publication No. 68-2-21. For terminations other than wire, the load shall be 20N.

Test 'Ub', Bending (Pliable terminations)

Method 1. Five consecutive bends through an angle of 45° (90° total arc).

Test 'Uc', Torsion (Axial termination wires)

Method A - Severity 2.

N.B.

When both tests are considered applicable, one half of the test lot shall be subjected to Test 'Ub' and the other half to Test 'Uc'.

9.14.3 Final Examination and Measurements

After each of the tests defined above, the components shall be visually examined. There shall be no visible evidence of damage other than clamping tool marks on the terminations. Voltage drop shall be measured and shall meet the requirements of Table 6 of the Detail Specification.

9.15 IMMERSION

Before starting this test, the components shall be subjected to 10 cycles of the tests defined in Para. 9.2. No measurements shall be made before or after cycling.

9.15.1 Mounting

Components shall be mounted by their normal mounting means and, where applicable; to the torque rating defined in the Detail Specification.

9.15.2 Procedure

Immediately following the rapid change of temperature test, the components shall undergo 2 cycles of immersion. Each cycle shall consist of immersion in a bath of fresh (tap) water at a temperature of +65(+5-0) °C followed by immersion in such water at +25(+10-5) °C. The duration of each immersion shall be 15 minutes. Transfer of devices from one bath to the other shall be accomplished as rapidly as practicable. After completion of the cycles the components shall be thoroughly and quickly washed and all surfaces wiped or air-blown clean and dry.

**9.15.3 Final Examination and Measurements**

The components shall be visually examined and there shall be no obliteration of marking, no harmful or extensive corrosion. Plating of metal surfaces shall be at least 90% intact and there shall be not more than 10% corrosion of terminal hardware or mounting surface. After not less than 4, or more than 24, hours a voltage proof test, at 90% of rated voltage, insulation resistance test and insertion loss measurements shall be conducted and shall comply with the requirements of Table 6 of the Detail Specification.

9.16 OVERLOAD

The components shall be suspended by their conductors in free air at an ambient temperature of +20°C minimum. A current, equal to 140% of rated dc current, shall then be applied for a minimum of 15 minutes. After the components have returned to room temperature the insulation resistance and voltage drop shall be measured and shall meet the requirements of Table 6 of the Detail Specification. The components shall be visually inspected for evidence of physical damage.

9.17 RESISTANCE TO SOLDERING HEAT**9.17.1 Procedure**

Before starting this test, the components shall be stabilised at room temperature for not less than 15 minutes. Each terminal, to which solder is normally applied, shall be subjected to the requirements of IEC Publication No. 68-2-20, Test 'Tb' Method 1A with the following conditions:

- Depth of Immersion: 2(+0.5-0) mm from the component body.
- Duration: 10 ± 1.0 s.

No heat sink or thermal screen shall be used during this test.

9.17.2 Final Examination and Measurements

After a recovery period under room conditions, of 1 to 2 hours, the components shall be visually examined and there shall be no evidence of physical damage. Insulation resistance and insertion loss shall be measured and shall comply with Table 6 of the Detail Specification.

9.18 SOLDERABILITY**9.18.1 Ageing**

Prior to the solderability test, components shall be aged in accordance with Ageing 1a, Test 'Ta' of IEC Publication No. 68-2-20.

9.18.2 Procedure

The components shall then be subjected to Test 'Ta' of IEC Publication No. 68-2-20, using either Method 1, 2 or 3, as appropriate.

When using Method 1, the termination shall be immersed up to 2(+0.5-0) mm from the point where they emerge from the body. A thermal screen may be employed if defined in the Detail Specification.

When using Method 2, a Size 'A' soldering iron shall be used over the area 2 to 5 mm from the component body.

When using Method 3, the soldering time shall not exceed 1 second. It shall be followed, after a period of not less than 3 minutes, by the de-wetting test with an immersion 2.5 ± 0.5 mm from the component body.

**9.18.3 Final Examination**

The components shall be examined in accordance with the requirements of IEC Publication No. 68-2-20, Test 'Ta', using Paras. 4.6.4, 4.7.4 or 4.9.3 as appropriate.

9.19 OPERATING LIFE**9.19.1 Operating Life during Qualification Testing****(a) Duration: 2000 hours****(b) Method of Mounting**

Components shall be mounted by their normal mounting means. Screw terminations shall be set, to the torque defined in the Detail Specification, in a clearance hole on a rigid metal plate.

Components shall be separated from each other by not less than 25mm and radiation shields may be placed between units, if desired, so that overheating of one unit will not affect a nearby unit.

(c) Operating Conditions

Operating temperature, test voltage and current shall be as specified in Table 5 of the Detail Specification. The test voltage shall be applied to the components individually through a resistor in such a manner that the charging current does not exceed $50\mu\text{A}/\text{pF}$ for $C \leq 1000\text{pF}$ or 0.05A for $C > 1000\text{pF}$.

If ac rated components are tested, the value of the series resistor shall be such that the voltage appearing across the test unit is not less than 95% of the applied voltage.

A voltage source shall be used which is capable of supplying at least 1.0 ampere when a component is short-circuited.

A method shall be provided to indicate short-circuits or leakage currents of 1.0mA or greater.

(d) Intermediate and End Data Points

Measurements at intermediate and end data points in accordance with Table 6 of the Detail Specification at 0, 500 ± 48 , 1000 ± 48 and 2000 ± 48 hours.

Prior to the recovery period, an insulation resistance test shall be conducted at the elevated temperature.

A recovery period of 24 hours at standard atmosphere conditions shall be allowed at intermediate and end-points and then the following tests shall be conducted:-

(i) Voltage proof at 90% of rated voltage.

(ii) Insulation resistance.

(iii) Insertion loss.

(iv) Capacitance.

In cases where Table 6 specifies "changes", the drift shall always be related to the 0-hour measurement.

(e) Failures

A component shall be considered as failed when a temporary or permanent short-circuit or open-circuit occurs in any section of the component, or between any section and the case, or between sections.

**9.19.2 Operating Life during Lot Acceptance Testing****(a) Duration: 1000 hours****(b) Method of Mounting**

Components shall be mounted by their normal mounting means. Screw terminations shall be set, to the torque defined in the Detail Specification, in a clearance hole on a rigid metal plate.

Components shall be separated from each other by not less than 25mm and radiation shields may be placed between units, if desired, so that overheating of one unit will not affect a nearby unit.

(c) Operating Conditions

Operating temperature, test voltage and current shall be as specified in Table 5 of the Detail Specification. The test voltage shall be applied to the components individually through a resistor in such a manner that the charging current does not exceed $50\mu\text{A/pF}$ for $C \leq 1000\text{pF}$ or 0.05A for $C > 1000\text{pF}$.

If ac rated components are tested, the value of the series resistor shall be such that the voltage appearing across the test unit is not less than 95% of the applied voltage.

A voltage source shall be used which is capable of supplying at least 1.0 ampere when a component is short-circuited.

A method shall be provided to indicate short-circuits or leakage currents of 1.0mA or greater.

(d) Intermediate and End Data Points

Measurements at intermediate and end data points in accordance with Table 6 of the Detail Specification at 0, 500 ± 48 and 1000 ± 48 hours.

Prior to the recovery period, an Insulation Resistance test shall be conducted at the elevated temperature.

A recovery period of 24 hours at standard atmosphere conditions shall be allowed at intermediate and end-points and then the following tests shall be conducted:-

- (i) Voltage proof at 90% of rated voltage.
- (ii) Insulation resistance.
- (iii) Insertion loss.
- (iv) Capacitance.

In cases where Table 6 specifies "changes", the drift shall always be related to the 0-hour measurement.

(e) Failures

A component shall be considered as failed when a temporary or permanent short-circuit or open-circuit occurs in any section of the component, or between any section and the case, or between sections.

9.20 CORROSION

For components with metal plated parts, the plating integrity shall be tested in accordance with IEC Publication No. 68-2-11 for a period of 96 hours. On completion of the test, the components shall be visually examined for obliteration of markings or corrosion. Damage to surfaces shall not exceed 10% of the surface area.

**9.21 PERMANENCE OF MARKING**

In accordance with ESA/SCC Basic Specification No. 24800.

9.22 FINAL ASSEMBLY

Final assembly shall be performed in accordance with the Process Identification Document (P.I.D.).

9.23 BURN-IN

The test shall be conducted in accordance with IEC Publication No. 384-1, Clause 4.23. At the end of the burn-in and while still at the high temperature, the components shall be subjected to an insulation resistance measurement and shall comply with the limits defined in Table 3 of the Detail Specification.

9.24 DAMP HEAT (FOR NON-HERMETICALLY SEALED DEVICES)**9.24.1 Mounting**

Components shall be mounted by their normal mounting means and, where applicable, to the torque rating defined in the Detail Specification.

9.24.2 Procedure

The components shall be placed in the test chamber and maintained, for a period of 168 hours, in the following conditions:

- Humidity: 85%
- Temperature: +85(+2-0) °C

9.24.3 Electrical Conditions

Components shall have a potential applied as follows:

Devices with multilayer (discoidal) ceramic capacitor(s)



dc Voltage: 1.5V with a series resistor not exceeding 20kΩ.

Devices with tubular ceramic capacitor

dc Voltage: Rated voltage as defined in the Detail Specification.

9.24.4 Final Examination and Measurements

After a recovery period at room conditions of 4 hours, the components shall be visually examined. There shall be no evidence of cracking or separation of the encapsulant from the case or inner conductors. The insulation resistance shall be measured, using the potential applied during the test, and shall comply with the requirements of Table 6 of the Detail Specification.

 	<p style="text-align: center;">ESA/SCC Generic Specification No. 3008</p>	<p style="text-align: center;">Rev. 'A'</p>	<p>PAGE 34 ISSUE 4</p>
---	---	---	----------------------------

10. DATA DOCUMENTATION

10.1 GENERAL

For the qualification approval records and with each component delivery, a data documentation package is required. Depending on the testing level and lot acceptance level specified for the component, this package shall be compiled from:-

- (a) Cover sheet (or sheets).
- (b) List of equipment (testing and measuring).
- (c) List of test references.
- (d) Special in-process control test data (when required by the Detail Specification).
- (e) Final production test data (Chart II) (but see Para 10.6).
- (f) Burn-in and electrical measurement data (Chart III).
- (g) Qualification test data (Chart IV).
- (h) Lot acceptance test data (Chart V) (when applicable).
- (i) Failed components list (see Paras. 7.3 and 8.4) and failure analysis report (see Para 8.4).
- (j) Certificate of Conformity.
- (k) Radiographic inspection photographs.

Items (a) to (k) inclusive shall be grouped, preferably as subpackages and, for identification purposes, each page shall include the following information:

- ESA/SCC Component Number.
- Manufacturer's name.
- Lot identification.
- Date of establishment of the document.
- Page number.

10.1.1 Qualification Approval

In the case of qualification approval, the items listed in Para 10.1 (a) to (k) less item (h) are required.

10.1.2 Testing Level 'B'

10.1.2.1 Qualified Components

For deliveries of qualified components, the following documentation shall be supplied:-

- (a) Cover sheet (if all of the information is not included on the Certificate of Conformity).
- (b) Certificate of Conformity (including range of delivered serial numbers).
- (c) Attributes record of measurements, tests and inspections performed in Chart II, Chart III (including PDA figure) and Chart V (where applicable).
- (d) Failed components list.

	<p style="text-align: center;">ESA/SCC Generic Specification No. 3008</p>	<p style="text-align: center;">Rev. 'A'</p>	<p style="text-align: right;">PAGE 35 ISSUE 4</p>
---	---	---	---

10.1.2.2 Unqualified Components

For deliveries of unqualified components, the documentation to be supplied shall be in accordance with Para. 10.1.2.1 plus the following:-

- (a) Read and record data from Chart III.
- (b) Special in-process control data (where applicable).
- (c) Failure analysis report on failed components.

10.1.3 Testing Level 'C'

10.1.3.1 Qualified Components

For deliveries of qualified components, the following documentation shall be supplied:-

- (a) Certificate of Conformity.

10.1.3.2 Unqualified Components

For deliveries of unqualified components, the documentation to be supplied shall be in accordance with Para. 10.1.3.1 plus the following:-

- (a) Cover sheet (if all of the information is not included on the Certificate of Conformity).
- (b) Attributes record of all measurements, tests and inspections performed in Charts II, III and V (when applicable).
- (c) Failed components list (including Failure Analysis Report).
- (d) Special in-process control data (when applicable).

10.1.4 Data Retention/Data Access

If not delivered, all data shall be retained by the Manufacturer for a minimum of 5 years during which time it shall be available to the Qualifying Space Agency and the Orderer, if requested, for review. The Manufacturer shall deliver variables Data/Reports to the Orderer if required by the Purchase Order.

10.2 COVER SHEET(S)

The cover sheet(s) of the data documentation package shall include as a minimum:-

- (a) Reference to the Detail Specification, including issue and date.
- (b) Reference to the Generic Specification, including issue and date.
- (c) Component type and number.
- (d) Lot identification.
- (e) Range of delivered serial numbers (for components of testing level 'B').
- (f) Number of purchase order.
- (g) Information relative to any additions to this specification and/or the Detail Specification.
- (h) Manufacturer's name and address.
- (i) Location of the manufacturing plant.
- (j) Signature on behalf of Manufacturer.
- (k) Total number of pages of the data package.

**10.3 LIST OF EQUIPMENT USED**

A list of equipment used for tests and measurements shall be prepared, if not in accordance with the data given in the Process Identification Document (P.I.D.). Where applicable, this list shall contain inventory number, Manufacturer's type number, serial number, etc. This list shall indicate for which tests such equipment was used.

10.4 LIST OF TEST REFERENCES

This list shall include all Manufacturer's references or codes which are necessary to correlate the test data provided with the applicable tests specified in the tables of the Detail Specification.

10.5 SPECIAL IN-PROCESS CONTROL DATA

As specified in the Detail Specification.

10.6 FINAL PRODUCTION TEST DATA (CHART II)

A test result summary shall be compiled showing the total number of components submitted to, and the total number rejected after, each of the following tests:

- Internal Visual Inspection (Para. 9.1).
- Rapid Change of Temperature (Para. 9.2).
- Vibration (Para. 9.3).
- Electrical Measurements at Room Temperature (Para. 9.4.4).
- Dimension Check (Para. 9.5).
- Seal Test (if performed) (Para. 9.6).
- External Visual Inspection (Para. 9.7).

The Final Production test data shall form an integral part of the data documentation package, but it is not a mandatory requirement that it be delivered with the qualification lot or delivery lot. However, the data package to be delivered shall contain the information as detailed in Paras. 10.1.2 and 10.1.3 or at least shall contain a list of final production tests actually performed and a certification that the data is available for review.

10.7 BURN-IN AND ELECTRICAL MEASUREMENT DATA (CHART III)**10.7.1 Testing Level 'B'**

For components of testing level 'B' all data shall refer to the relevant serial numbers. Against these serial numbers, data shall be recorded of the following:-

- (a) 0-hour measurement for burn-in.
- (b) 168 hour measurement for burn-in.
- (c) Delta values after burn-in.
- (d) Values obtained during measurements at high and low temperatures (Table 3 of the Detail Specification).
- (e) Values obtained during measurements at room temperature (Table 2 of the Detail Specification).
- (f) Failures during external visual inspection.
- (g) Failures during seal test (if performed).
- (h) Photographs from radiographic inspection, including those of reject components.

**10.7.2 Testing Level 'C'**

For components of testing level 'C' a test result summary (i.e. the total number of components subjected to, and the total number rejected from, each of the tests and inspections) shall be prepared.

10.8 QUALIFICATION TEST DATA (CHART IV)

All data shall be referenced to the relevant serial numbers. Detailed records shall be provided of the components submitted to each test in each of the subgroups and of those rejected.

Detailed data shall be provided of all electrical measurements made in accordance with Tables 2 and 6 of the Detail Specification, as and where applicable.

10.9 LOT ACCEPTANCE TEST DATA (CHART V)**10.9.1 Testing Level 'B'**

All data shall be referenced to the relevant serial numbers. Detailed records shall be provided of the components submitted to each test in each of the subgroups (as relevant to the lot acceptance level) and of those rejected.

Detailed data shall be provided of all electrical measurements made in accordance with Tables 2, 3 and 6 of the Detail Specification, as and where applicable.

10.9.2 Testing Level 'C'

A test result summary (i.e. the total number of components submitted to, and the total number of components rejected from, each of the tests and inspections) as relevant to the lot acceptance level, shall be provided.

In the case of lot acceptance 2 testing, all data in respect of electrical measurements made in accordance with Table 6 of the Detail Specification shall be referenced to the relevant serial numbers (see Para. 8.2.4(a)).

In the case of lot acceptance 1 testing, all data in respect of electrical measurements made in accordance with Tables 2 and 6 of the Detail Specification shall be referenced to the relevant serial numbers (see Para. 8.2.5(a)).



10.10 FAILED COMPONENTS LIST AND FAILURE ANALYSIS REPORT

The failed component list and failure analysis report shall provide full details of:-

- (a) The reference number and description of the test or measurement performed as defined in this specification and/or the Detail Specification.
- (b) The serial number (if applicable) of the failed component.
- (c) The failed parameter and the failure mode of the components.
- (d) Detailed failure analysis, if requested.

10.11 CERTIFICATE OF CONFORMITY

A Certificate of Conformity shall be established as defined in ESA/SCC Basic Specification No. 20100.

		ESA/SCC Generic Specification No. 3008		PAGE 38 ISSUE 4
--	--	---	--	--------------------

11. **DELIVERY**

For qualification approval, the disposition of the qualification test lot and its related documentation shall be as specified in ESA/SCC Basic Specification No. 20100 and the relevant paragraphs of Section 10 of this specification.

For procurement, for each order, the items forming the delivery are:-

- (a) The delivery lot.
- (b) The components used for lot acceptance testing, (when applicable), but not forming part of the delivery lot (see Paras. 8.2.3(d), 8.2.4(b) and 8.2.5(b)).
- (c) The relevant documentation in accordance with the requirements of Section 10 of this specification.

In the case of a component for which a valid qualification approval is in force, all data of all components submitted to LA1 and LA2 testing shall also be copied, when requested, to the relevant Qualifying Space Agency.

12. **PACKAGING AND DESPATCH**

The packaging and despatch of components to this specification shall be in accordance with the requirements of ESA/SCC Basic Specification No. 20600.



ANNEXE I

LTPD SAMPLING PLAN FOR LOT SIZES GREATER THAN 200 DEVICES

Minimum size of sample to be tested to assure with a 90% confidence that a lot whose Percent Defective equals the specified LTPD is not accepted (single sample).

Max. Percent Defective (LTPD) or λ	50	30	20	15	10	7	5	3	2	1.5	1	0.7	0.5	0.3	0.2	0.15	0.1
Acceptance Number (c) ($r = c + 1$)	MINIMUM SAMPLE SIZES (FOR DEVICE-HOURS REQUIRED FOR LIFE TEST, MULTIPLY BY 1000)																
0	5 (1.03)	8 (0.64)	11 (0.46)	15 (0.34)	22 (0.23)	32 (0.16)	45 (0.11)	76 (0.07)	116 (0.04)	153 (0.03)	231 (0.02)	328 (0.02)	461 (0.01)	767 (0.007)	1152 (0.005)	1534 (0.003)	2303 (0.002)
1	8 (4.4)	13 (2.7)	18 (2.0)	25 (1.4)	38 (0.94)	55 (0.65)	77 (0.46)	129 (0.28)	195 (0.18)	258 (0.14)	390 (0.09)	555 (0.06)	778 (0.045)	1296 (0.027)	1946 (0.018)	2592 (0.013)	3891 (0.009)
2	11 (7.4)	18 (4.5)	25 (3.4)	34 (2.24)	52 (1.6)	75 (1.1)	105 (0.78)	176 (0.47)	266 (0.31)	354 (0.23)	533 (0.15)	759 (0.11)	1065 (0.080)	1773 (0.045)	2662 (0.031)	3547 (0.022)	5323 (0.015)
3	13 (10.5)	22 (6.2)	32 (4.4)	43 (3.2)	65 (2.1)	94 (1.5)	132 (1.0)	221 (0.62)	333 (0.41)	444 (0.31)	668 (0.20)	953 (0.14)	1337 (0.10)	2226 (0.062)	3341 (0.041)	4452 (0.031)	6681 (0.018)
4	16 (12.3)	27 (7.3)	38 (5.3)	52 (3.9)	78 (2.6)	113 (1.8)	158 (1.3)	265 (0.75)	398 (0.50)	531 (0.37)	798 (0.25)	1140 (0.17)	1599 (0.12)	2663 (0.074)	3997 (0.049)	5327 (0.037)	7994 (0.025)
5	19 (13.8)	31 (8.4)	45 (6.0)	60 (4.4)	91 (2.9)	131 (2.0)	184 (1.4)	308 (0.85)	462 (0.57)	617 (0.42)	927 (0.28)	1323 (0.20)	1855 (0.14)	3090 (0.085)	4638 (0.056)	6181 (0.042)	9275 (0.028)
6	21 (15.6)	35 (9.4)	51 (6.6)	68 (4.9)	104 (3.2)	149 (2.2)	209 (1.6)	349 (0.94)	528 (0.62)	700 (0.47)	1054 (0.31)	1503 (0.22)	2107 (0.155)	3509 (0.093)	5267 (0.062)	7019 (0.047)	10533 (0.031)
7	24 (16.6)	39 (10.2)	57 (7.2)	77 (5.3)	116 (3.5)	166 (2.4)	234 (1.7)	390 (1.0)	589 (0.67)	783 (0.51)	1178 (0.34)	1680 (0.24)	2355 (0.17)	3922 (0.101)	5886 (0.067)	7845 (0.051)	11771 (0.034)
8	26 (18.1)	43 (10.9)	63 (7.7)	85 (5.6)	128 (3.7)	184 (2.6)	258 (1.8)	431 (1.1)	648 (0.72)	864 (0.54)	1300 (0.36)	1854 (0.25)	2599 (0.18)	4329 (0.108)	6498 (0.072)	8660 (0.054)	12995 (0.036)
9	28 (19.4)	47 (11.5)	69 (8.1)	93 (6.0)	140 (3.9)	201 (2.7)	282 (1.9)	471 (1.2)	709 (0.77)	945 (0.58)	1421 (0.38)	2027 (0.27)	2842 (0.19)	4733 (0.114)	7103 (0.077)	9468 (0.057)	14206 (0.038)
10	31 (19.9)	51 (12.1)	75 (8.4)	100 (6.3)	152 (4.1)	218 (2.9)	306 (2.0)	511 (1.2)	770 (0.80)	1025 (0.60)	1541 (0.40)	2199 (0.28)	3082 (0.20)	5133 (0.120)	7704 (0.080)	10268 (0.060)	15407 (0.040)
11	33 (21.0)	54 (12.8)	83 (8.3)	111 (6.2)	166 (4.2)	238 (2.9)	332 (2.1)	555 (1.2)	832 (0.83)	1109 (0.62)	1664 (0.42)	2378 (0.29)	3323 (0.21)	5546 (0.12)	8319 (0.083)	11092 (0.062)	16638 (0.042)
12	36 (21.4)	59 (13.0)	89 (8.6)	119 (6.5)	178 (4.3)	254 (3.0)	356 (2.2)	594 (1.3)	890 (0.86)	1187 (0.65)	1781 (0.43)	2544 (0.3)	3562 (0.22)	5936 (0.13)	8904 (0.086)	11872 (0.065)	17808 (0.043)
13	38 (22.3)	63 (13.4)	95 (8.9)	126 (6.7)	190 (4.5)	271 (3.1)	379 (2.26)	632 (1.3)	948 (0.89)	1264 (0.67)	1896 (0.44)	2709 (0.31)	3793 (0.22)	6321 (0.134)	9482 (0.089)	12643 (0.067)	18964 (0.045)
14	40 (23.1)	67 (13.8)	101 (9.2)	134 (6.9)	201 (4.6)	288 (3.2)	403 (2.3)	672 (1.4)	1007 (0.92)	1343 (0.69)	2015 (0.46)	2878 (0.32)	4029 (0.23)	6716 (0.138)	10073 (0.092)	13431 (0.069)	20146 (0.046)
15	43 (23.3)	71 (14.1)	107 (9.4)	142 (7.1)	213 (4.7)	305 (3.3)	426 (2.36)	711 (1.41)	1066 (0.94)	1422 (0.71)	2133 (0.47)	3046 (0.33)	4265 (0.235)	7108 (0.141)	10662 (0.094)	14216 (0.070)	21324 (0.047)
16	45 (24.1)	74 (14.0)	112 (9.7)	150 (7.2)	225 (4.8)	321 (3.37)	450 (2.41)	750 (1.44)	1124 (0.96)	1499 (0.72)	2249 (0.48)	3212 (0.337)	4497 (0.241)	7496 (0.144)	11244 (0.096)	14992 (0.072)	22487 (0.048)
17	47 (24.7)	79 (14.7)	118 (9.86)	158 (7.36)	236 (4.93)	338 (3.44)	473 (2.46)	788 (1.48)	1182 (0.98)	1576 (0.74)	2364 (0.49)	3377 (0.344)	4728 (0.246)	7880 (0.148)	11819 (0.098)	15759 (0.074)	23639 (0.049)
18	50 (24.9)	83 (15.0)	124 (10.0)	165 (7.54)	248 (5.02)	354 (3.51)	496 (2.51)	826 (1.51)	1239 (1.0)	1652 (0.75)	2478 (0.50)	3540 (0.351)	4956 (0.251)	8260 (0.151)	12390 (0.100)	16520 (0.075)	24780 (0.050)
19	52 (25.5)	86 (15.4)	130 (10.2)	173 (7.76)	259 (5.12)	370 (3.58)	518 (2.56)	864 (1.53)	1296 (1.02)	1728 (0.77)	2591 (0.52)	3702 (0.358)	5183 (0.256)	8638 (0.153)	12957 (0.102)	17276 (0.077)	25914 (0.051)
20	54 (26.1)	90 (15.6)	135 (10.4)	180 (7.82)	271 (5.19)	386 (3.65)	541 (2.60)	902 (1.56)	1353 (1.04)	1803 (0.78)	2705 (0.52)	3864 (0.364)	5410 (0.260)	9017 (0.156)	13526 (0.104)	18034 (0.078)	27051 (0.052)
26	65 (27.0)	109 (16.1)	163 (10.8)	217 (8.08)	326 (5.38)	466 (3.76)	652 (2.69)	1086 (1.61)	1629 (1.08)	2173 (0.807)	3259 (0.538)	4656 (0.376)	6518 (0.269)	10863 (0.161)	16295 (0.108)	21726 (0.081)	32589 (0.054)

- Sample sizes are based upon the Poisson exponential binomial limit.
- The minimum quality (approximate AQL) required to accept (on the average) 19 of 20 lots is shown in parentheses for information only.



SCC

ESA/SCC Generic Specification

No. 3008

PAGE 40



ISSUE 4

ANNEXE I

Page 2 of 3

LTPD SAMPLING PLAN FOR LOT SIZES LESS THAN, OR EQUAL TO, 200 DEVICES

C=0													
N	10	20	30	40	50	60	80	100	120	150	160	200	
n	AQL LTPD	AQL LTPD	AQL LTPD	AQL LTPD	AQL LTPD	AQL LTPD	AQL LTPD	AQL LTPD	AQL LTPD	AQL LTPD	AQL LTPD	AQL LTPD	AQL LTPD
2	2.2 65	2.5 66	2.5 67	2.5 67	2.5 67	2.5 68	2.5 68	2.5 68	2.5 68	2.5 68	2.5 68	2.5 68	2.5 68
4	1.2 36	1.2 40	1.2 42	1.2 42	1.3 42	1.3 43	1.3 43	1.3 43	1.3 43	1.3 43	1.3 43	1.3 44	1.3 44
5	1.0 29	1.0 33	1.0 34	1.0 35	1.0 35	1.0 35	1.0 36	1.0 36	1.0 37	1.0 37	1.0 37	1.0 37	1.0 37
8	0.5 15	0.6 20	0.6 22	0.6 23	0.6 23	0.6 23	0.6 24	0.7 24	0.7 24	0.7 24	0.7 24	0.7 24	0.7 25
10		0.4 15	0.5 17	0.5 19	0.5 19	0.5 19	0.5 20	0.5 20	0.5 20	0.5 20	0.5 20	0.5 20	0.5 20
16		0.2 6.9	0.25 10	0.25 11	0.3 11	0.3 12	0.3 12	0.3 13	0.3 13	0.3 13	0.3 13	0.3 13	0.3 13
20			0.2 6.8	0.2 8.0	0.25 8.7	0.25 9.0	0.25 9.4	0.25 10	0.25 10	0.25 10	0.25 10	0.25 11	0.25 11
25			0.15 4.3	0.15 5.7	0.2 6.4	0.2 6.9	0.2 7.4	0.2 7.5	0.2 7.6	0.2 7.7	0.2 7.8	0.2 7.8	0.2 7.9
32				0.1 3.7	0.1 4.4	0.1 5.0	0.1 5.5	0.1 5.9	0.15 6.0	0.15 6.2	0.15 6.3	0.15 6.3	0.15 6.3
40					0.1 3.0	0.1 3.4	0.1 4.0	0.1 4.5	0.1 4.6	0.1 4.9	0.1 5.0	0.1 5.0	0.15 5.0
50						0.1 2.3	0.1 2.9	0.10 3.3	0.10 3.5	0.10 3.7	0.10 3.7	0.10 3.9	0.10 3.9
64							0.08 1.7	0.08 2.2	0.08 2.5	0.08 2.7	0.08 2.8	0.08 2.8	0.08 2.9
80								0.07 1.5	0.07 1.7	0.07 2.0	0.07 2.1	0.07 2.1	0.07 2.2
100									0.05 1.1	0.05 1.5	0.05 1.5	0.05 1.5	0.05 1.7
125										0.04 0.8	0.04 0.9	0.04 0.9	0.04 1.2
128													0.04 1.1
160													0.03 0.7
C=1													
N	10	20	30	40	50	60	80	100	120	150	160	200	
n	AQL LTPD	AQL LTPD	AQL LTPD	AQL LTPD	AQL LTPD	AQL LTPD	AQL LTPD	AQL LTPD	AQL LTPD	AQL LTPD	AQL LTPD	AQL LTPD	AQL LTPD
2	27 95	24 95	24 95	23 95	23 95	23 95	23 95	23 95	23 95	22 95	22 95	22 95	22 95
4	15 62	12 66	12 66	11 67	11 67	10 67	10 67	10 67	10 67	9.8 67	9.7 67	9.7 68	9.7 68
5	13 51	10 55	8.8 56	8.5 57	8.4 57	8.1 58	7.9 58	7.6 58	7.5 58	7.5 58	7.5 58	7.5 58	7.5 58
8	11 28	7.2 35	6.2 38	5.8 38	5.4 39	5.0 39	4.7 39	4.5 39	4.3 39	4.3 40	4.2 40	4.2 40	4.2 40
10		6.2 30	5.0 30	4.6 31	4.2 32	4.2 32	4.2 32	3.9 33	3.5 33	3.3 33	3.3 33	3.3 33	3.3 33
16		5.6 15	4.2 18	3.8 18	3.4 20	3.0 20	2.9 21	2.6 21	2.5 21	2.3 21	2.3 22	2.2 22	2.2 22
20			4.0 13	3.2 15	2.8 16	2.5 16	2.4 16	2.3 16	2.1 17	2.0 17	2.0 17	2.0 18	2.0 18
25			3.8 9.2	3.1 11	2.5 12	2.2 13	2.0 13	1.8 13	1.7 13	1.6 14	1.6 14	1.6 14	1.6 14
32				3.1 7.4	2.4 8.2	2.1 9.0	1.8 9.9	1.6 10	1.5 10.5	1.4 11	1.3 11	1.3 11	1.3 11
40					2.4 5.9	2.1 6.8	1.6 7.6	1.4 7.8	1.3 8.2	1.2 8.3	1.2 8.4	1.2 8.4	1.2 8.6
50						1.7 4.6	1.4 5.6	1.2 6.1	1.2 6.4	1.0 6.5	0.9 6.7	0.9 6.7	0.9 6.7
64							1.3 3.8	1.1 4.4	1.0 4.7	0.8 5.0	0.8 5.0	0.7 5.2	0.7 5.2
80								1.1 3.0	1.0 3.4	0.8 3.7	0.7 3.8	0.6 4.0	0.6 4.0
100									0.9 2.5	0.7 2.8	0.7 2.8	0.6 3.0	0.6 3.0
125										0.7 1.9	0.7 2.0	0.5 2.2	0.5 2.2
128										0.7 1.7	0.7 1.9	0.5 2.2	0.5 2.2
160												0.5 1.5	0.5 1.5
C=2													
N	10	20	30	40	50	60	80	100	120	150	160	200	
n	AQL LTPD	AQL LTPD	AQL LTPD	AQL LTPD	AQL LTPD	AQL LTPD	AQL LTPD	AQL LTPD	AQL LTPD	AQL LTPD	AQL LTPD	AQL LTPD	AQL LTPD
4	33 82	28 83	27 84	27 85	27 85	26 85	26 85	26 86	26 86	25 86	25 86	25 86	25 86
5	27 69	23 73	21 74	20 74	20 74	20 75	20 75	19 75	19 75	19 75	19 75	19 75	19 75
8	22 42	15 49	14 49	13 52	13 52	13 52	12 53	12 53	12 53	11 53	11 53	11 53	11 53
10		13 39	11 42	11 42	10 43	10 43	9.6 43	9.2 44	9.1 44	8.9 44	8.9 44	8.7 44	8.7 44
16		11 22	8.6 25	6.9 27	6.8 27	6.4 27	6.0 28	6.0 29	5.9 29	5.9 29	5.7 29	5.5 30	5.5 30
20			7.7 19	6.2 21	5.9 22	5.6 22	5.1 23	4.8 23	4.8 23	4.6 23	4.5 24	4.5 24	4.5 24
25			7.4 13	6.0 16	4.9 17	4.5 17	4.3 18	4.1 18	3.9 18	3.7 18	3.7 19	3.7 19	3.7 19
32				5.5 11	4.8 12	4.3 13	3.6 14	3.4 14	3.2 14	3.0 14.5	3.0 15	2.9 15	2.9 15
40					4.6 8.9	3.9 9.8	3.1 11	2.8 12	2.6 12	2.4 12	2.4 12	2.3 12	2.3 12
50						3.5 6.9	2.8 8.1	2.4 8.4	2.3 8.6	2.1 9.0	2.1 9.3	2.0 9.5	2.0 9.5
64							2.6 5.7	2.2 6.2	2.0 6.6	1.8 7.1	1.7 7.1	1.6 7.4	1.6 7.4
80								2.1 4.5	1.8 4.9	1.6 5.4	1.5 5.4	1.4 5.6	1.4 5.6
100									1.8 3.5	1.4 3.9	1.4 4.0	1.2 4.4	1.2 4.4
125										1.4 2.8	1.3 2.9	1.1 3.3	1.1 3.3
128										1.4 2.6	1.3 2.9	1.1 3.2	1.1 3.2
160												1.1 2.3	1.1 2.3

		<p>ESA/SCC Generic Specification No. 3008</p>		<p>PAGE 41 ISSUE 4</p>
---	---	---	--	----------------------------

ANNEXE I

This table gives the AQL and LTPD values associated with certain single sampling plans (Acceptance Number "C", Sample Size "n" and Lot Size "N"). The table has the following features:-

- (a) Calculations are based upon the hyper-geometric distribution (exact theory) for lot sizes of 200 devices or less.
- (b) The AQL of a sampling plan is defined as the interpolated Percent Defective for which there is a 0.95 probability of acceptance under the plan. The AQL so defined need not be a realisable Lot Percent Defective for the lot size involved (e.g., 12 percent is not a realisable Percent Defective for a lot size of 20 devices).
- (c) The LTPD of a sampling plan is defined as the interpolated Percent Defective for which there is a 0.10 probability of lot acceptance under the plan. The LTPD so defined need not be a realisable Lot Percent Defective for the lot size involved.
- (d) The sequence of sample sizes and lot sizes are generated by taking products of preceding numbers in the respective sequences and the numbers 2 and 5.