



**europaean space agency  
agence spatiale européenne**

Pages 1 to 121

**CRYSTAL UNITS IN METAL HOLDER,**

**BASED ON TYPE 807,**

**FREQUENCY RANGE 4.0 - 140MHZ**

**ESA/SCC Detail Specification No. 3501/001**





**space components  
coordination group**

Issue/Rev.	Date	Approved by	
		SCCG Chairman	ESA Director General or his Deputy
Issue 3	February 1998		
Revision 'A'	June 1998		
Revision 'B'	January 1999		
Revision 'C'	May 2000		

**DOCUMENTATION CHANGE NOTICE**

Rev. Letter	Rev. Date	Reference	CHANGE Item	Approved DCR No.
		This Issue supersedes Issue 2 and incorporates all modifications defined in Revisions 'A', 'B', 'C' and 'D' to Issue 2 and the changes agreed in the following DCRs:-		
		Cover Page		None
		DCN		None
		Table 1(a)	: Storage Temperature Range column deleted	221336
		Table 1(b)	: No. 4, in Remarks, Note number amended	221336
			: No. 5, in Remarks, Note number amended	221336
			: New Note 3 added	221336
			: Existing Note 3 renumbered as "4"	221336
		Table 1(c)	: Item 20 deleted	221336
			: Existing Item 21 renumbered as "20"	221336
		Figure 2	: Drawing and Table amended	221381
			: Vibration Axes and Notes added	221381
		Figure 3	: Notes deleted	221381
		Para. 4.3.3	: Second sentence deleted	221341
		Para. 4.5.1	: Existing text deleted and new text added	221465
		Para. 4.5.5	: Deleted in toto	221465
		Para. 4.5.6	: Renumbered to "4.5.5"	221465
		Para. 4.6.1	: Second sentence rewritten	221341
		Para. 4.6.3	: Deleted in toto	221341
		Para. 4.6.4	: Renumbered to "4.6.3"	221341
		Table 6	: Table reformatted	23799/ 221341/ 221380/ 221465 221336
		Ind. Tables 1(a)	: Item 20 deleted	221336
'A'	Jun. '98	P1. Cover Page P2. DCN P8. Table 1(a)	: Storage Temperature Range column deleted	None None 221476
'B'	Jan. '99	P1. Cover Page P2. DCN P9. Table 1(b)	: No. 2, Value deleted and "Note 1" added : Note 1 Table, Drive Level Range added	None None 221507 221507
'C'	May '00	P1. Cover Page P2. DCN P13. Figure 2	: In the Table, dimension 'C' max. amended	None None 221548

 	<p style="text-align: center;">ESA/SCC Detail Specification No. 3501/001</p>	<p>PAGE 3 ISSUE 3</p>
---	--	---------------------------

**TABLE OF CONTENTS**

		<u>Page</u>
<b>1.</b>	<b><u>GENERAL</u></b>	<b>5</b>
1.1	Scope	5
1.2	Type Variants	5
1.3	Maximum Ratings	5
1.4	Physical Dimensions	5
1.5	Functional Diagram	5
<b>2.</b>	<b><u>APPLICABLE DOCUMENTS</u></b>	<b>14</b>
<b>3.</b>	<b><u>TERMS, DEFINITIONS, ABBREVIATIONS, SYMBOLS AND UNITS</u></b>	<b>14</b>
<b>4.</b>	<b><u>REQUIREMENTS</u></b>	<b>14</b>
4.1	General	14
4.2	Deviations from Generic Specification	14
4.2.1	Deviations from Special In-process Controls	14
4.2.2	Deviations from Final Production Tests	14
4.2.3	Deviations from Burn-in Tests	14
4.2.4	Deviations from Qualification Tests	14
4.2.5	Deviations from Lot Acceptance Tests	14
4.3	Mechanical Requirements	15
4.3.1	Dimension Check	15
4.3.2	Weight	15
4.3.3	Robustness of Terminations	15
4.4	Materials and Finishes	15
4.4.1	Case	15
4.4.2	Lead Material and Finish	15
4.5	Marking	15
4.5.1	General	15
4.5.2	The SCC Component Number	15
4.5.3	Characteristics	16
4.5.4	Traceability Information	16
4.5.5	Manufacturer's Name, Symbol and Code	16
4.6	Electrical Measurements	16
4.6.1	Electrical Measurements at Reference Temperature	16
4.6.2	Electrical Measurements at High and Low Temperatures	16
4.6.3	Circuits for Electrical Measurements	16
4.7	Burn-in Tests	16
4.7.1	Parameter Drift Values	16
4.7.2	Conditions for Burn-in	16
4.7.3	Electrical Circuits for Burn-in	16
4.8	Environmental and Endurance Tests	19
4.8.1	Measurements and Inspections on Completion of Environmental Tests	19
4.8.2	Measurements and Inspections at Intermediate Points and on Completion of Endurance Tests	19
4.8.3	Conditions for Operating Life Test	19

Page**TABLES**



1(a)	Type Variant Summary	6
	Type Variant Detailed Information	23
1(b)	Maximum Ratings	9
1(c)	Format for Individual Tables 1(a)	10
2	Electrical Measurements at Reference Temperature	17
3	Electrical Measurements at High and Low Temperatures	18
4	Parameter Drift Values	18
5	Conditions for Burn-in and Life Test	18
6	Measurements and Inspections on Completion of Environmental Tests and at Intermediate Points and on Completion of Endurance Testing	20

**FIGURES**

1	Parameter Derating Information	N/A
2	Physical Dimensions	13
3	Functional Diagram	13
4	Circuits for Electrical Measurements	N/A
5	Electrical Circuit for Burn-in and Life Test	N/A

**APPENDICES (Applicable to specific Manufacturers only)**

None.

		<p>ESA/SCC Detail Specification No. 3501/001</p>	<p>PAGE 5 ISSUE 3</p>
---	---	--	---------------------------

## 1. GENERAL

### 1.1 SCOPE

This specification details the values, physical and electrical characteristics, test and inspection data for Crystal Units in Metal Holder, based on Type 807, Frequency Range 4.0 - 140MHz.

It shall be read in conjunction with ESA/SCC Generic Specification No. 3501, the requirements for which are supplemented herein.

### 1.2 TYPE VARIANTS

A list of the type variants of the crystal units specified herein, which are also covered by this specification, is given in "Table 1(a) - Type Variant Summary".

For each type variant, the full electrical and physical characteristics are given in individual Tables 1(a) - "Type Variant Detailed Information" at the end of this specification.

The contents of the individual Tables 1(a) shall be as shown in Table 1(c) and the characteristics therein listed shall relate to the design parameters of the individual crystal units, optimised for the intended application.

The specific characteristics shall be negotiated between the Manufacturer and the Orderer. The Manufacturer shall then apply to the ESA/SCC Secretariat for a type variant number for each individual crystal unit concerned, by sending a finalised Table 1(a) which shall also be copied to the Qualifying Space Agency (QSA).

### 1.3 MAXIMUM RATINGS

The maximum ratings, which shall not be exceeded at any time during use or storage, applicable to the crystal units specified herein, are as scheduled in Table 1(b).

### 1.4 PHYSICAL DIMENSIONS

The physical dimensions of the crystal units specified herein are shown in Figure 2.

### 1.5 FUNCTIONAL DIAGRAM

The functional diagram showing lead identification of the crystal units specified herein is shown in Figure 3.

**TABLE 1(a) - TYPE VARIANT SUMMARY**

Variant	Resonance Frequency (MHz)	Load Capacitance (C <sub>L</sub> pF)	Reference Temp. (T <sub>o</sub> °C)	Operating Temp. Range (T <sub>op</sub> °C)	Lead Length (Dim. L mm)	
					Min.	Max.
01	65.34375	∞	+ 25	-25 to + 70	12.7	-
02	68.4373	∞	+ 25	-20 to + 70	12.7	-
03	71.9686	∞	+ 25	-20 to + 70	12.7	-
04	82.53	∞	+ 25	-20 to + 70	12.7	-
05	83.07	∞	+ 25	-20 to + 70	12.7	-
06	83.335	∞	+ 25	-20 to + 70	12.7	-
07	84.210526	∞	+ 25	-20 to + 70	12.7	-
08	84.868421	∞	+ 25	-20 to + 70	12.7	-
09	85.087737	∞	+ 25	-20 to + 70	12.7	-
10	85.964947	∞	+ 25	-20 to + 70	12.7	-
11	36.866968	∞	+ 25	-20 to + 70	12.7	-
12	37.166667	∞	+ 25	-20 to + 70	12.7	-
13	65.052865	∞	+ 25	-20 to + 70	12.7	-
14	70.0	∞	+ 25	-20 to + 70	12.7	-
15	102.083333	∞	+ 25	-20 to + 50	12.7	-
16	15.0	50	+ 40	-20 to + 80	12.7	-
17	16.0	50	+ 60	-30 to + 70	12.7	-
18	15.84	50	+ 25	-55 to + 105	12.7	-
19	16.0 -16.384	22	+ 60	-20 to + 70	12.7	-
20	16.35	30	+ 25	-20 to + 70	12.7	-
21	18.84	∞	+ 25	-20 to + 55	12.7	-
22	18.84	32	+ 25	-20 to + 55	12.7	-
23	15.0	32	+ 25	-30 to + 70	12.7	-
24	20.0	22	+ 60	-20 to + 70	12.7	-
25	36.693333	∞	+ 25	-20 to + 70	12.7	-
26	20.8333	10	+ 25	-10 to + 60	12.7	-
27	22.841667	30	+ 25	-25 to + 65	12.7	-
28	22.856667	44	+ 25	-20 to + 50	12.7	-
29	22.861667	30	+ 25	-20 to + 65	12.7	-
30	24.184	32	+ 25	-10 to + 50	12.7	-
31	24.5	30	+ 25	-20 to + 60	12.7	-
32	24.5	32	+ 25	-20 to + 55	12.7	-
33	36.666 -38.333	∞	+ 25	-20 to + 60	12.7	-
34	38.25618	55	+ 22	0 to + 40	12.7	-
35	55.46875	20	+ 45	+ 43 to + 47	12.7	-
36	62.5 - 68.125	10	+ 25	-10 to + 60	12.7	-
37	71.859475	57.5	+ 25	-20 to + 50	12.7	-
38	75.36015	57.5	+ 25	-20 to + 50	12.7	-

**TABLE 1(a) - TYPE VARIANT SUMMARY (Continued)**

Variant	Resonance Frequency (MHz)	Load Capacitance (C <sub>L</sub> pF)	Reference Temp. (T <sub>0</sub> °C)	Operating Temp. Range (T <sub>op</sub> °C)	Lead Length (Dim. L mm)	
					Min.	Max.
39	79.516319	26.5	+30	-10 to +70	12.7	-
40	80.381944	26.5	+25	-25 to +65	12.7	-
41	81.847222	26.5	+25	-25 to +65	12.7	-
42	99.1	∞	+25	-20 to +60	12.7	-
43	105.0	10	+25	-10 to +60	12.7	-
44	120.796	∞	+25	-10 to +50	12.7	-
45	61.805555	∞	+25	-20 to +70	12.7	-
46	62.5	∞	+25	-20 to +70	12.7	-
47	62.03125	∞	+25	-20 to +70	12.7	-
48	62.109375	∞	+25	-20 to +70	12.7	-
49	69.559524	∞	+25	-20 to +70	12.7	-
50	69.619048	∞	+25	-20 to +70	12.7	-
51	24.68617	30	+25	-20 to +70	12.7	-
52	82.53	∞	+25	-20 to +70	12.7	-
53	83.07	∞	+25	-20 to +70	12.7	-
54	37.063617	∞	+25	-20 to +70	12.7	-
55	37.083333	∞	+25	-20 to +70	12.7	-
56	61.1875					-
57	65.00311	∞	+25	-20 to +70	12.7	-
58	85.48	∞	+25	-20 to +70	12.7	-
59	46.08005	12	+25	-20 to +70	12.7	-
60	16.0	22	+60	-20 to +70	12.7	-
61	38.3117284	∞	+25	-20 to +60	12.7	-
62	15.0	35	+60	-30 to +70	12.7	-
63	16.0	22	+60	-20 to +70	12.7	-
64	16.384	22	+60	-20 to +70	12.7	-
65	65.0047	∞	+25	-20 to +70	12.7	-
66	65.0513	∞	+25	-20 to +70	12.7	-
67	69.9992	∞	+25	-20 to +70	12.7	-
68	85.4792	∞	+25	-20 to +70	12.7	-
69	50.0	30	+25	-5 to +55	12.7	-
70	20.0	22	+60	-20 to +70	12.7	-
71	8.0	30	+25	-35 to +105	12.7	-
72	37.74375	∞	+25	-20 to +70	12.7	-
73	37.827083	∞	+25	-20 to +70	12.7	-
74	5.24288	30	+25	-25 to +105	12.7	-
75	4.096	30	+25	-25 to +75	12.7	-
76	5.12	30	+25	-35 to +105	12.7	-
77	6.5536	30	+25	-35 to +105	12.7	-
78	65.04974	∞	+25	-20 to +70	12.7	-

**TABLE 1(a) - TYPE VARIANT SUMMARY (Continued)**

Variant	Resonance Frequency (MHz)	Load Capacitance (C <sub>L</sub> pF)	Reference Temp. (T <sub>o</sub> °C)	Operating Temp. Range (T <sub>op</sub> °C)	Lead Length (Dim. L mm)	
					Min.	Max.
79	65.005555	∞	+ 25	-20 to + 70	12.7	-
80	62.5	∞	+ 25	-20 to + 70	12.7	-
81	70.0	∞	+ 25	-20 to + 70	12.7	-
82	4.1379	30	+ 25	-25 to + 75	12.7	-
83	65.03639	∞	+ 25	-20 to + 70	12.7	-
84	36.811767	∞	+ 25	-25 to + 70	12.7	-
85	20.0	∞	+ 25	-30 to + 70	12.7	-
86	20.0	32	+ 25	-30 to + 70	12.7	-
87	81.506849	∞	+ 70	-20 to + 80	12.7	-
88	121.5	∞	+ 25	-30 to + 80	12.7	-
89	50.0	∞	+ 25	-30 to + 80	12.7	-
90	37.75625	∞	+ 25	-20 to + 70	12.7	-
91	24.6827	∞	+ 25	-20 to + 70	12.7	-
92	37.839583	∞	+ 25	-20 to + 70	12.7	-
93	90.875794	∞	+ 25	-20 to + 70	12.7	-
94	90.881675	∞	+ 25	-20 to + 70	12.7	-
95	90.88754	∞	+ 25	-20 to + 70	12.7	-
96	90.893413	∞	+ 25	-20 to + 70	12.7	-
97	99.53704	∞	+ 25	-20 to + 70	12.7	-
98	20.0	∞	+ 25	-55 to + 105	12.7	-
99	24.5	32	+ 25	-20 to + 70	12.7	-

**NOTES**

1. Full electrical and physical characteristics are given in the individual Tables 1(a) at the end of this specification.



**TABLE 1(b) - MAXIMUM RATINGS**

No.	Characteristic	Symbol	Values	Unit	Remarks
1	Nominal Frequency Range	f	4.0 to 140	MHz	Note 1
2	Drive Level Range	P	Note 1	mW	
3	Operating Temperature Range	T <sub>op</sub>	-	°C	Note 2
4	Storage Temperature Range	T <sub>stg</sub>	-65 to +125	°C	Note 3
5	Soldering Temperature	T <sub>sol</sub>	+260	°C	Note 4

**NOTES**

1.

Fundamental and Overtone Order	Approx. Frequency Range (MHz)	Drive Level Range (mW)
Fundamental	4 - 35	0.05 to 0.2
3	30 - 100	0.05 to 0.25
5	80 - 140	0.05 to 0.25

2. See Table 1(a).

3. The duration at maximum storage temperature shall not exceed 16 hours.

4. Duration 10 seconds maximum at a distance of not less than 3.0mm from the device body and the same lead shall not be resoldered until 3 minutes have elapsed.



**TABLE 1(c) - FORMAT FOR INDIVIDUAL TABLES 1(a)**

**TABLE 1(a) - TYPE VARIANT DETAILED INFORMATION**

TYPE VARIANT NO. \_\_\_\_\_

No.	Characteristic	Symbol	Limits		Unit	Remarks
			Min.	Max		
1	Resonance Frequency	$f_r$ or $f_L$			MHz	Note 1
2	Reference Temperature	$T_o$			°C	Note 2
3	Overtone Order	-				
4	Load Capacitance	$C_L$			pF	Note 3
5	Rated Drive Level	$P_o$			mW	Note 4
6	Frequency Adjustment Tolerance	$\frac{\Delta f}{f}$			10 <sup>-6</sup>	At $T_o$ °C Note 5
7	Resonance Resistance	$R_r$ or $R_L$			Ω	At $T_o$ °C Note 6
8	Frequency Variation with Temperature over $T_{op}$	$\frac{\Delta f}{f}$			10 <sup>-9</sup>	From frequency measured at $T_o$ °C Note 7
9	Resistance Variation with Temperature over $T_{op}$	$\frac{\Delta R}{R}$			%	From resistance measured at $T_o$ °C Note 7
10	Operating Temperature Range	$T_{op}$			°C	
11	Frequency variation with Drive Level	$\frac{\Delta f}{f}$			10 <sup>-6</sup>	From $P_{S1} =$ mW to $P_{S2} =$ mW Note 8
12	Resistance variation with Drive Level	$\frac{\Delta R}{R}$			%	From $P_{S1} =$ mW to $P_{S2} =$ mW Note 8
13	Motional Inductance	$L_1$			mH	Notes 9 and 10
14	Motional Capacitance	$C_1$			fF	Note 9
15	Static Capacitance	$C_o$			pF	Note 9
16	Q Factor	Q			-	Notes 9 and 11
17	Ratio of unwanted: Response Resistance to Resonance Resistance or Response Impedance to Resonance Resistance	$R_p/R$ or $ Z_p /R$				In the frequency range: f - kHz to f + kHz
18	Ageing	$\frac{\Delta f}{f}$			10 <sup>-6</sup>	Note 13
19	Terminal length	L			mm	Note 14
20	Intended Application	-				Note 16

**NOTES:** See Pages 11 and 12.

**NOTES TO TABLE 1(c)**

1. (a) If  $C_L$  is not specified, Symbol and measurement shall be  $f_r$ .  
(b) If  $C_L$  is specified, Symbol and measurement shall be  $f_L$ .
2. Reference Temperature  $T_o$ 
  - (a) For a crystal unit functioning in a non-controlled temperature environment, the reference temperature is normally  $+25 \pm 2$  °C.
  - (b) For a crystal unit functioning in a controlled temperature environment, the reference temperature shall normally be the mid-point of the temperature range of the controlled environment.
3. Load Capacitance  $C_L$ 
  - (a) When a crystal unit must function at its series resonance frequency,  $C_L$  shall be infinite.
  - (b) When a crystal must function with a load capacitance, the  $C_L$  value shall be specified. The standard values of load capacitance are as follows:
    - Fundamental Frequency Operation: 20pF, 30pF, 50pF and 100pF.
    - Overtone Operation: 8pF, 12pF, 15pF, 20pF and 30pF.

**N.B**

The tolerance on the load capacitance shall be that value which results in a frequency change not exceeding 10% of the frequency tolerance at  $T_o$  or 1% of the nominal load capacitance, whichever is smaller.



4. Rated Drive Level  $P_o$ 

The rated drive level shall be selected from the standard drive levels specified below:

  - Preferred values: 2mW, 1mW, 0.5mW, 0.2mW, 0.1mW, 0.05mW, 0.02mW, 0.01mW, 0.001mW or 0.0001mW at  $\pm 20\%$ .
  - Non-preferred values: 10mW, 5mW and 4mW all at  $\pm 20\%$ .
5. Frequency Adjustment Tolerance
  - (a) When a crystal must function at its series resonance frequency, the standard value of the adjustment tolerance shall be  $\pm 10 \times 10^{-6}$ .
  - (b) When a crystal has to function with a load capacitance, the standard value of the adjustment tolerance shall also be  $\pm 10 \times 10^{-6}$ . However, if the load capacitance is adjustable, it is preferable to specify that the nominal frequency be obtained with a load capacitance value between the minimum and maximum value when the crystal is functioning in its fundamental mode.
6. Resonance Resistance
  - (a) Generally, the maximum value only is specified.
  - (b)  $R_L$  may be calculated by  $R_L = R_r \left( 1 + \frac{C_o}{C_L} \right)^2$
7. Frequency and Resistance Variation with Temperature

These values shall be specified such that they are consistent with the operating temperature range.
8. Frequency and Resistance Variation with Drive Level

These limits and the Drive Level range ( $P_{S1}$  to  $P_{S2}$ ) shall be specified for very special crystals only (i.e. crystals used in very high stability oscillators).

		<p>ESA/SCC Detail Specification No. 3501/001</p>	<p>PAGE 12 ISSUE 3</p>
---	---	--	----------------------------

**NOTES TO TABLE 1(c) (Continued)**

9. Electrical Values

The electrical values shall be specified only when required for the correct functioning of the equipment in which the crystal is used.

10. Motional Inductance  $L_1$

Because the inductance value may be restricted by other chosen parameters, the Manufacturer shall propose the value of  $L_1$  in accordance with the Customer's requirements.

11. 'Q' Factor

If 'R' and 'L' have been already specified, it will not be necessary to specify the minimum value of the 'Q' factor.

The maximum value of the 'Q' factor is never specified.

12. Ratio of Unwanted Response Resistance to Resonance Resistance

The standard minimum value is 2, but it is possible to obtain higher values.

The frequency range within which the minimum value of the ratio is required shall also be specified.

13. Ageing

Specify limits under appropriate column and ageing period under "Remarks".

14. Terminal Lengths

To be specified if different from Figure 2 dimensions. If dimensions are as per Figure 2 then "Figure 2" to be entered in the Limits column.

15. Not applicable Items

For all items where limits are not specified, "Not applicable" shall be entered in the Limits column.

16. Intended Application

For definitions of the selected symbol to be added, see ESA/SCC Generic Specification No. 3501, Para. 3.

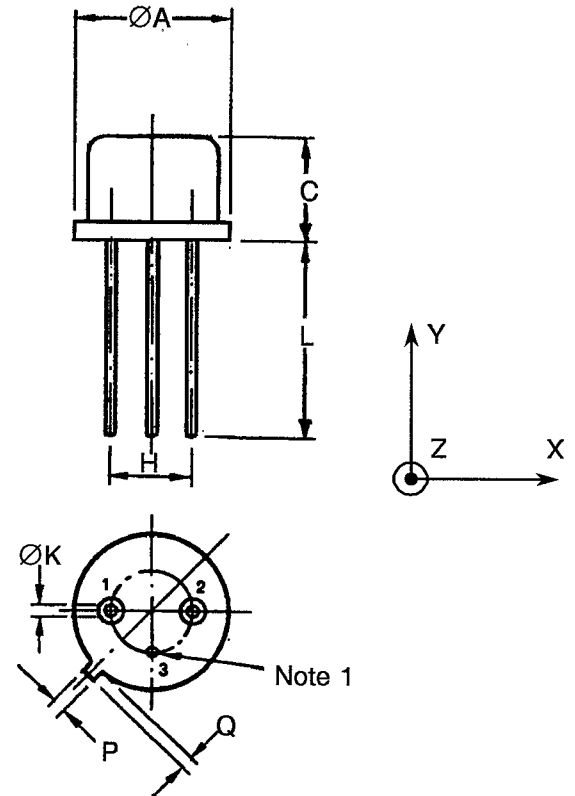

**FIGURE 1 - PARAMETER DERATING INFORMATION**

Not applicable.

**FIGURE 2 - PHYSICAL DIMENSIONS**

Symbol	Millimetres		Remarks
	Min.	Max.	
$\varnothing A$	-	10.70	-
C	-	6.80	-
H	4.83	5.33	Pitch 5.08mm
$\varnothing K$	0.40	0.48	-
L	12.70	-	-
P	-	0.90	Note 2
Q	-	0.95	Note 2



**NOTES**

1. Lead No. 3 is grounded to case.
2. The tag's position or presence is optional.

**FIGURE 3 - FUNCTIONAL DIAGRAM**

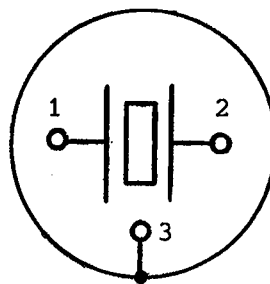

(Bottom View)



## 2. APPLICABLE DOCUMENTS

The following documents form part of this specification and shall be read in conjunction with it:-

- (a) ESA/SCC Generic Specification No. 3501 for Quartz Crystal Units.

## 3. TERMS, DEFINITIONS, ABBREVIATIONS, SYMBOLS AND UNITS

For the purpose of this specification, the terms, definitions, abbreviations, symbols and units specified in ESA/SCC Basic Specification No. 21300 shall apply. In addition, the following symbols are used:-

Resonance Frequency	= $f_r$
Load Resonance Frequency	= $f_L$
Reference Temperature	= $T_o$
Resonance Resistance	= $R_r$
Load Resonance Resistance	= $R_L$
Rated Drive Level	= $P_o$
Static Capacitance	= $C_o$
Load Capacitance	= $C_L$
Motional Capacitance	= $C_1$
Motional Inductance	= $L_1$
Response Resistance	= $R_p$
Response Impedance	= $ Z_p $
Insulation Resistance	= $R_i$

## 4. REQUIREMENTS

### 4.1 GENERAL

The complete requirements for procurement of the crystal units specified herein shall be as stated in this specification and ESA/SCC Generic Specification No. 3501 for Quartz Crystal Units. Deviations from the Generic Specification applicable to this specification only, are detailed in Para. 4.2.

Deviations from the applicable Generic Specification and this Detail Specification, formally agreed with specific Manufacturers on the basis that the alternative requirements are equivalent to the ESA/SCC requirements and do not affect the components' reliability, are listed in the appendices attached to this specification.

### 4.2 DEVIATIONS FROM GENERIC SPECIFICATION

#### 4.2.1 Deviations from Special In-process Controls

None.

#### 4.2.2 Deviations from Final Production Tests (Chart II)

None.

#### 4.2.3 Deviations from Burn-in Tests (Chart III)

None.

#### 4.2.4 Deviations from Qualification Tests (Chart IV)

None.

#### 4.2.5 Deviations from Lot Acceptance Tests (Chart V)

None.



#### 4.3 MECHANICAL REQUIREMENTS

##### 4.3.1 Dimension Check

The dimensions of the crystal units specified herein shall be checked. They shall conform to those shown in Figure 2.

##### 4.3.2 Weight

The maximum weight of the crystal units specified herein shall be 2.0 grammes.

##### 4.3.3 Robustness of Terminations

The requirements for robustness of termination testing are specified in Section 9 of ESA/SCC Generic Specification No. 3501.

#### 4.4 MATERIALS AND FINISHES

The materials and finishes shall be as specified herein. Where a definite material is not specified, a material which will enable the crystal units specified herein to meet the performance requirements of this specification shall be used. Acceptance or approval of any constituent material does not guarantee acceptance of the finished product.

##### 4.4.1 Case

###### 4.4.1.1 Cap

Copper, nickel plated or nickel and gold plated.

###### 4.4.1.2 Base

Kovar, nickel plated and gold plated.

##### 4.4.2 Lead Material and Finish

The lead material shall be Type 'D' with Type '2' finish in accordance with the requirements of ESA/SCC Basic Specification No. 23500.

#### 4.5 MARKING

##### 4.5.1 General

The marking of all components delivered to this specification shall be in accordance with the requirements of ESA/SCC Basic Specification No. 21700 and the following paragraphs. When the component is too small to accommodate all of the marking specified, as much as space permits shall be marked and the marking information, in full, shall accompany the component in its primary package.

The information to be marked and the order of precedence, shall be as follows:-

- (a) The SCC Component Number.
- (b) Characteristics.
- (c) Traceability Information.

##### 4.5.2 The SCC Component Number

Each component shall bear the SCC Component Number, which shall be constituted and marked as follows:-

350100101B

Detail Specification Number \_\_\_\_\_

Type Variant (See Table 1(a)) \_\_\_\_\_

Testing Level (B or C, as applicable) \_\_\_\_\_



#### 4.5.3 Characteristics

The resonance frequency of the crystal units shall be clearly specified in MHz. Where necessary, it shall be specified to 6 decimal places.

#### 4.5.4 Traceability Information

Each component shall be marked in respect of traceability information in accordance with the requirements of ESA/SCC Basic Specification No. 21700.

#### 4.5.5 Manufacturer's Name, Symbol or Code

The Manufacturer's marking shall be in accordance with the requirements of ESA/SCC Basic Specification No. 21700.

### 4.6 ELECTRICAL MEASUREMENTS

#### 4.6.1 Electrical Measurements at Reference Temperature

The parameters to be measured in respect of electrical characteristics are scheduled in Table 2. The measurements shall be performed at the temperatures specified in the individual Tables 1(a), Item 2.

#### 4.6.2 Electrical Measurements at High and Low Temperatures

The parameters to be measured at high and low temperatures are scheduled in Table 3. These measurements shall only be performed if values are specified in Table 1(a) Items 8 and/or 9.

#### 4.6.3 Circuits for Electrical Measurements (Figure 4)

Not applicable.

### 4.7 BURN-IN TESTS

#### 4.7.1 Parameter Drift Values

The parameter drift values applicable to burn-in are specified in Table 4 of this specification. Unless otherwise stated, measurements shall be performed at  $T_{amb} = T_0 \pm 2 \text{ }^\circ\text{C}$ . The parameter drift values ( $\Delta$ ) applicable to the scheduled parameters shall not be exceeded. In addition to these drift value requirements for a given parameter, the appropriate limit value specified in Table 2 shall not be exceeded.

#### 4.7.2 Conditions for Burn-in

The requirements for burn-in are specified in Section 7 of ESA/SCC Generic Specification No. 3501. The conditions for burn-in shall be as specified in Table 5 of this specification.

#### 4.7.3 Electrical Circuits for Burn-in (Figure 5)

Not applicable.



**TABLE 2 - ELECTRICAL MEASUREMENTS AT REFERENCE TEMPERATURE**

No.	Characteristics	Symbol	ESA/SCC 3501 Test Method	Limits	Unit
1	Resonance frequency at reference temperature and rated drive level - with $C_O$ - with $C_L$	$f_r (T_o, P_o)$ $f_L (T_o, P_o)$	Para. 9.2.1.1	Table 1(a), Item 1 $\pm$ Item 6	MHz
2	Resonance resistance at reference temperature and rated drive level - with $C_O$ - with $C_L$	$R_r (T_o, P_o)$ $R_L (T_o, P_o)$	Para. 9.2.1.1	Table 1(a), Item 7	$\Omega$
3	Frequency variation with Drive Level	$\frac{\Delta f}{f} (T_o, \Delta P)$	Para. 9.2.1.1	Table 1(a), Item 11	$10^{-6}$
4	Resistance variation with Drive Level	$\frac{\Delta R}{R} (T_o, \Delta P)$	Para. 9.2.1.1	Table 1(a), Item 12	%
5	Motional Inductance	$L_1$	Para. 9.2.1.3	Table 1(a), Item 13	mH
6	Static Capacitance	$C_o$	Para. 9.2.1.4	Table 1(a), Item 15	pF
7	Unwanted response	$R_p/R$ or $ Z_p /R$	Para. 9.2.1.5	Table 1(a), Item 17	-
8	Insulation Resistance	$R_i$	Para. 9.2.1.6	500 Min.	$M\Omega$

**TABLE 3 - ELECTRICAL MEASUREMENTS AT HIGH AND LOW TEMPERATURES**

No.	Characteristics	Symbol	ESA/SCC 3501 Test Method	Limits	Unit
9	Frequency variation with Temperature over T <sub>op</sub>	$\frac{\Delta f}{f} (\Delta T, P_0)$	Para. 9.2.1.2	Table 1(a) Item 8	10 <sup>-6</sup>
10	Resistance variation with Temperature over T <sub>op</sub>	$\frac{\Delta R}{R} (\Delta T, P_0)$	Para. 9.2.1.2	Table 1(a) Item 9	%

**FIGURE 4 - CIRCUITS FOR ELECTRICAL MEASUREMENTS**

Not applicable.

**TABLE 4 - PARAMETER DRIFT VALUES**

No.	Characteristics	Symbol	Spec. and/or Test Method	Test Conditions	Change Limits ( $\Delta$ )	Unit
1	Resonance frequency drift	$\frac{\Delta f}{f}$	As per Table 2	As per Table 2	$\pm 2.0$	10 <sup>-6</sup>
2	Resonance resistance drift	$\frac{\Delta R}{R}$	As per Table 2	As per Table 2	$\pm 10$ or (1) $\pm 1.0$	%  $\Omega$

**NOTES** 1. Whichever is the highest value.**TABLE 5 - CONDITIONS FOR BURN-IN AND LIFE TEST**

No.	Characteristics	Symbol	Condition	Unit
1	Ambient Temperature	T <sub>amb</sub>	+ 85 $\pm$ 5	°C

**FIGURE 5 - ELECTRICAL CIRCUIT FOR BURN-IN AND LIFE TEST**

Not applicable.



- 4.8 ENVIRONMENTAL AND ENDURANCE TESTS (CHARTS IV AND V OF ESA/SCC GENERIC SPECIFICATION NO. 3501)
- 4.8.1 Measurements and Inspections on Completion of Environmental Tests  
The parameters to be measured and inspections to be performed on completion of environmental tests are scheduled in Table 6. Unless otherwise stated, the measurements shall be performed at  $T_{amb} = T_o \pm 2 \text{ }^\circ\text{C}$ .
- 4.8.2 Measurements and Inspections at Intermediate Points and on Completion of Endurance Tests  
The parameters to be measured and inspections to be performed at intermediate points and on completion of endurance tests are scheduled in Table 6. Unless otherwise stated, the measurements shall be performed at  $T_{amb} = T_o \pm 2 \text{ }^\circ\text{C}$ .
- 4.8.3 Conditions for Operating Life Test (Part of Endurance Testing)  
The requirements for the operating life test are specified in Section 9 of ESA/SCC Generic Specification No. 3501. The test shall be performed as a high temperature storage test and the temperature to be applied shall be the maximum operating temperature specified in the individual Tables 1(a) given in this specification.



**TABLE 6 - MEASUREMENTS AND INSPECTIONS ON COMPLETION OF ENVIRONMENTAL TESTS AND AT INTERMEDIATE POINTS AND ON COMPLETION OF ENDURANCE TESTING**

NO.	ESA/SCC GENERIC SPEC. NO. 3501		MEASUREMENTS AND INSPECTIONS		SYMBOL	LIMITS		UNIT
	ENVIRONMENTAL AND ENDURANCE TESTS (1)	TEST METHOD AND CONDITIONS	IDENTIFICATION	CONDITIONS		Min.	Max.	
01	Electrical Measurements at Reference Temperature	Para. 9.2.4	Electrical Measurements	Table 2		Table 1(a)		
02	Shock	Para. 9.3	<b>Initial Measurements</b> Resonance Frequency Resonance Resistance <b>Final Measurements</b> Resonance Frequency Drift Resonance Resistance Drift	Table 2 Item 1 Table 2 Item 2  Table 2 Item 1 Table 2 Item 2	f R  $\frac{\Delta f}{f}$ $\frac{\Delta R}{R}$ $\Delta R$	Table 2 Item 1 Table 2 Item 2  - 1.0 - 10 or (2) - 1.0	+ 1.0 + 1.0  + 10 + 1.0	10 <sup>-6</sup>   %  Ω
03	Vibration	Para. 9.4	<b>Initial Measurements</b> Resonance Frequency Resonance Resistance <b>Final Measurements</b> Resonance Frequency Drift Resonance Resistance Drift	Table 2 Item 1 Table 2 Item 2  Table 2 Item 1 Table 2 Item 2	f R  $\frac{\Delta f}{f}$ $\frac{\Delta R}{R}$ $\Delta R$	Table 2 Item 1 Table 2 Item 2  - 1.0 - 10 or (2) - 1.0	+ 1.0 + 1.0  + 10 + 1.0	10 <sup>-6</sup>   %  Ω
04	Seal Test	Para. 9.5	Fine Leak Gross Leak	Para. 9.5.1 Para. 9.5.2		Para. 9.5.1 Para. 9.5.2		
05	Permanence of Marking	Para. 9.8	<b>Final Measurements</b> Visual Examination	No corrosion or obliteration of marking	-	-	-	-
06	External Visual Inspection	Para. 9.9	<b>Final Measurements</b> Visual Inspection	ESA/SCC No. 20500	-	-	-	-
07	Solderability	Para. 9.13	-	-	-	-	-	-

**NOTES**

1. The tests in this table refer to either Chart IV or V, and shall be used as applicable.
2. Whichever is the highest value.



**TABLE 6 - MEASUREMENTS AND INSPECTIONS ON COMPLETION OF ENVIRONMENTAL TESTS AND AT INTERMEDIATE POINTS AND ON COMPLETION OF ENDURANCE TESTING (Cont.)**

NO.	ESA/SCC GENERIC SPEC. NO. 3501		MEASUREMENTS AND INSPECTIONS		SYMBOL	LIMITS		UNIT
	ENVIRONMENTAL AND ENDURANCE TESTS (1)	TEST METHOD AND CONDITIONS	IDENTIFICATION	CONDITIONS		Min.	Max.	
08	Climatic Sequence Dry Heat	Para. 9.14 Para. 9.14.1	<b>Initial Measurements</b>					
			Resonance Frequency	Table 2 Item 1	f	Table 2 Item 1		
			Resonance Resistance	Table 2 Item 2	R	Table 2 Item 2		
			<b>Final Measurements</b>					
09	Cold	Para. 9.14.3	Resonance Frequency	Table 2 Item 1	$\frac{\Delta f}{f}$	-2.0	+2.0	10 <sup>-6</sup>
			Drift					
			Resonance Resistance	Table 2 Item 2	$\frac{\Delta R}{R}$	-10	+10	%
			Drift		$\Delta R$	or (2) -1.0	+1.0	$\Omega$
10	Damp Heat (Accelerated) Remaining Cycles	Para. 9.14.4	<b>Initial Measurements</b>					
			Resonance Frequency	Table 2 Item 1	f	Para. 9.14.1.3		
			Resonance Resistance	Table 2 Item 2	R	Final Measurements		
			<b>Final Measurements</b>					
11	Rapid Change of Temperature	Para. 9.15	Resonance Frequency	Table 2 Item 1	$\frac{\Delta f}{f}$	-2.0	+2.0	10 <sup>-6</sup>
			Drift					
			Resonance Resistance	Table 2 Item 2	$\frac{\Delta R}{R}$	-10	+10	%
			Drift		$\Delta R$	or (2) -1.0	+1.0	$\Omega$
12	Robustness of Terminations	Para. 9.16	Tensile Strength	Gen. 3501 Para. 9.16.1				
			Visual Examination Bending	No visible damage Gen. 3501 Para. 9.16.2				
			Visual Examination	No visible damage				
			Insulation Resistance	Table 2 Item 8	R <sub>i</sub>	500	-	M $\Omega$

**NOTES**

1. The tests in this table refer to either Chart IV or V, and shall be used as applicable.
2. Whichever is the highest value.



**TABLE 6 - MEASUREMENTS AND INSPECTIONS ON COMPLETION OF ENVIRONMENTAL TESTS AND AT INTERMEDIATE POINTS AND ON COMPLETION OF ENDURANCE TESTING (Cont.)**

NO.	ESA/SCC GENERIC SPEC. NO. 3501		MEASUREMENTS AND INSPECTIONS		SYMBOL	LIMITS		UNIT	
	ENVIRONMENTAL AND ENDURANCE TESTS (1)	TEST METHOD AND CONDITIONS	IDENTIFICATION	CONDITIONS		Min.	Max.		
13	Life Test	Para. 9.17	<b>Initial Measurements</b>						
			Resonance Frequency	Table 2 Item 1	f	Table 2 Item 1			
			Resonance Resistance	Table 2 Item 2	R	Table 2 Item 2			
			<b>Intermediate Measurements</b>	At 500 hours					
			Resonance Frequency Drift	Table 2 Item 1	$\frac{\Delta f}{f}$		-2.0	+2.0	10 <sup>-6</sup>
			Resonance Resistance Drift	Table 2 Item 2	$\frac{\Delta R}{R}$		-10 or (2)	+10	%
					$\Delta R$		-1.0	+1.0	$\Omega$
			<b>Intermediate Measurements (Chart IV) and Final Measurements (Chart V)</b>	At 1000 hours					
			Resonance Frequency Drift	Table 2 Item 1	$\frac{\Delta f}{f}$		-2.5	+2.5	10 <sup>-6</sup>
			Resonance Resistance Drift	Table 2 Item 2	$\frac{\Delta R}{R}$		-10 or (2)	+10	%
					$\Delta R$		-1.0	+1.0	$\Omega$
			<b>Final Measurements (Chart IV)</b>	At 2000 hours					
			Resonance Frequency Drift	Table 2 Item 1	$\frac{\Delta f}{f}$		-3.0	+3.0	10 <sup>-6</sup>
Resonance Resistance Drift	Table 2 Item 2	$\frac{\Delta R}{R}$		-10 or (2)	+10	%			
		$\Delta R$		-1.0	+1.0	$\Omega$			

**NOTES**

1. The tests in this table refer to either Chart IV or V, and shall be used as applicable.
2. Whichever is the highest value.



**TABLE 1(a) - TYPE VARIANT DETAILED INFORMATION**

TYPE VARIANT NO. 01

No.	Characteristics	Symbol	Limits		Unit	Remarks
			Min.	Max.		
1	Resonance Frequency	$f_r$	65.34375		MHz	Swept
2	Reference Temperature	$T_o$	+23	+27	°C	
3	Overtone Order	-	3			
4	Load Capacitance	$C_L$	$\infty$		pF	
5	Rated Drive Level	$P_o$	0.1		mW	
6	Frequency Adjustment Tolerance	$\frac{\Delta f}{f}$	-10	+10	$10^{-6}$	At $T_o$ °C
7	Resonance Resistance	$R_r$	-	40	$\Omega$	At $T_o$ °C
8	Frequency Variation with Temperature over $T_{op}$	$\frac{\Delta f}{f}$	-7.5	+7.5	$10^{-6}$	From frequency measured at $T_o$ °C
9	Resistance Variation with Temperature over $T_{op}$	$\frac{\Delta R}{R}$	-10	+10	%	From resistance measured at $T_o$ °C
10	Operating Temperature Range	$T_{op}$	-20	+70	°C	
11	Frequency variation with Drive Level	$\frac{\Delta f}{f}$	Not applicable		$10^{-6}$	
12	Resistance variation with Drive Level	$\frac{\Delta R}{R}$	Not applicable		%	
13	Motional Inductance	$L_1$	3.2	4.8	mH	
14	Motional Capacitance	$C_1$	Not applicable		fF	
15	Static Capacitance	$C_o$	-	7.0	pF	
16	Q Factor	Q	Not applicable		-	
17	Ratio of Unwanted: Response Resistance to Resonance Resistance or Response Impedance to Resonance Resistance	$R_p/R$ or $ Z_p /R$	2:1	-		In the frequency range: $f_r - 50\text{kHz}$ to $f_r + 50\text{kHz}$
18	Ageing	$\frac{\Delta f}{f}$	-3.0	+3.0	$10^{-6}$	After burn-in and per year
19	Terminal Length	L	Figure 2		mm	



**TABLE 1(a) - TYPE VARIANT DETAILED INFORMATION**

TYPE VARIANT NO. 02

No.	Characteristics	Symbol	Limits		Unit	Remarks
			Min.	Max.		
1	Resonance Frequency	$f_r$	68.4373		MHz	Swept
2	Reference Temperature	$T_o$	+23	+27	°C	
3	Overtone Order	-	3			
4	Load Capacitance	$C_L$	$\infty$		pF	
5	Rated Drive Level	$P_o$	0.1		mW	
6	Frequency Adjustment Tolerance	$\frac{\Delta f}{f}$	-10	+10	$10^{-6}$	At $T_o$ °C
7	Resonance Resistance	$R_r$	-	40	$\Omega$	At $T_o$ °C
8	Frequency Variation with Temperature over $T_{op}$	$\frac{\Delta f}{f}$	-7.5	+7.5	$10^{-6}$	From frequency measured at $T_o$ °C
9	Resistance Variation with Temperature over $T_{op}$	$\frac{\Delta R}{R}$	-10	+10	%	From resistance measured at $T_o$ °C
10	Operating Temperature Range	$T_{op}$	-20	+70	°C	
11	Frequency variation with Drive Level	$\frac{\Delta f}{f}$	Not applicable		$10^{-6}$	
12	Resistance variation with Drive Level	$\frac{\Delta R}{R}$	Not applicable		%	
13	Motional Inductance	$L_1$	3.2	4.8	mH	
14	Motional Capacitance	$C_1$	Not applicable		fF	
15	Static Capacitance	$C_o$	-	7.0	pF	
16	Q Factor	Q	Not applicable		-	
17	Ratio of Unwanted: Response Resistance to Resonance Resistance or Response Impedance to Resonance Resistance	$R_p/R$ or $ Z_p /R$	2:1	-		In the frequency range: $f_r - 50\text{kHz}$ to $f_r + 50\text{kHz}$
18	Ageing	$\frac{\Delta f}{f}$	-3.0	+3.0	$10^{-6}$	After burn-in, and per year
19	Terminal Length	L	Figure 2		mm	



**TABLE 1(a) - TYPE VARIANT DETAILED INFORMATION**TYPE VARIANT NO. 03

No.	Characteristics	Symbol	Limits		Unit	Remarks
			Min.	Max.		
1	Resonance Frequency	$f_r$	71.9686		MHz	Swept
2	Reference Temperature	$T_o$	+23	+27	°C	
3	Overtone Order	-	3			
4	Load Capacitance	$C_L$	$\infty$		pF	
5	Rated Drive Level	$P_o$	0.1		mW	
6	Frequency Adjustment Tolerance	$\frac{\Delta f}{f}$	-10	+10	$10^{-6}$	At $T_o$ °C
7	Resonance Resistance	$R_r$	-	40	$\Omega$	At $T_o$ °C
8	Frequency Variation with Temperature over $T_{op}$	$\frac{\Delta f}{f}$	-7.5	+7.5	$10^{-6}$	From frequency measured at $T_o$ °C
9	Resistance Variation with Temperature over $T_{op}$	$\frac{\Delta R}{R}$	-10	+10	%	From resistance measured at $T_o$ °C
10	Operating Temperature Range	$T_{op}$	-20	+70	°C	
11	Frequency variation with Drive Level	$\frac{\Delta f}{f}$	Not applicable		$10^{-6}$	
12	Resistance variation with Drive Level	$\frac{\Delta R}{R}$	Not applicable		%	
13	Motional Inductance	$L_1$	3.2	4.8	mH	
14	Motional Capacitance	$C_1$	Not applicable		fF	
15	Static Capacitance	$C_o$	-	7.0	pF	
16	Q Factor	Q	Not applicable		-	
17	Ratio of Unwanted: Response Resistance to Resonance Resistance or Response Impedance to Resonance Resistance	$R_p/R$ or $ Z_{pl}/R$	2:1	-		In the frequency range: $f_r - 50\text{kHz}$ to $f_r + 50\text{kHz}$
18	Ageing	$\frac{\Delta f}{f}$	-3.0	+3.0	$10^{-6}$	After burn-in, and per year
19	Terminal Length	L	Figure 2		mm	



**TABLE 1(a) - TYPE VARIANT DETAILED INFORMATION**

TYPE VARIANT NO. 04

No.	Characteristics	Symbol	Limits		Unit	Remarks
			Min.	Max.		
1	Resonance Frequency	$f_r$	82.53		MHz	Swept
2	Reference Temperature	$T_o$	+23	+27	°C	
3	Overtone Order	-	3			
4	Load Capacitance	$C_L$	$\infty$		pF	
5	Rated Drive Level	$P_o$	0.1		mW	
6	Frequency Adjustment Tolerance	$\frac{\Delta f}{f}$	-5.0	+5.0	$10^{-6}$	At $T_o$ °C
7	Resonance Resistance	$R_r$	-	40	$\Omega$	At $T_o$ °C
8	Frequency Variation with Temperature over $T_{op}$	$\frac{\Delta f}{f}$	-10	+10	$10^{-6}$	From frequency measured at $T_o$ °C
9	Resistance Variation with Temperature over $T_{op}$	$\frac{\Delta R}{R}$	-20	+20	%	From resistance measured at $T_o$ °C
10	Operating Temperature Range	$T_{op}$	-20	+70	°C	
11	Frequency variation with Drive Level	$\frac{\Delta f}{f}$	Not applicable		$10^{-6}$	
12	Resistance variation with Drive Level	$\frac{\Delta R}{R}$	Not applicable		%	
13	Motional Inductance	$L_1$	Not applicable		mH	
14	Motional Capacitance	$C_1$	Not applicable		fF	
15	Static Capacitance	$C_o$	-	7.0	pF	
16	Q Factor	Q	Not applicable		-	
17	Ratio of Unwanted: Response Resistance to Resonance Resistance or Response Impedance to Resonance Resistance	$R_p/R$ or $ Z_p /R$	2:1	-		In the frequency range: $f_r - 50\text{kHz}$ to $f_r + 50\text{kHz}$
18	Ageing	$\frac{\Delta f}{f}$	-3.0	+3.0	$10^{-6}$	After burn-in, and per year
19	Terminal Length	L	Figure 2		mm	



**TABLE 1(a) - TYPE VARIANT DETAILED INFORMATION**

TYPE VARIANT NO. 05

No.	Characteristics	Symbol	Limits		Unit	Remarks
			Min.	Max.		
1	Resonance Frequency	$f_r$	83.07		MHz	Swept
2	Reference Temperature	$T_o$	+23	+27	°C	
3	Overtone Order	-	3			
4	Load Capacitance	$C_L$	$\infty$		pF	
5	Rated Drive Level	$P_o$	0.1		mW	
6	Frequency Adjustment Tolerance	$\frac{\Delta f}{f}$	-5.0	+5.0	$10^{-6}$	At $T_o$ °C
7	Resonance Resistance	$R_r$	-	40	$\Omega$	At $T_o$ °C
8	Frequency Variation with Temperature over $T_{op}$	$\frac{\Delta f}{f}$	-10	+10	$10^{-6}$	From frequency measured at $T_o$ °C
9	Resistance Variation with Temperature over $T_{op}$	$\frac{\Delta R}{R}$	-20	+20	%	From resistance measured at $T_o$ °C
10	Operating Temperature Range	$T_{op}$	-20	+70	°C	
11	Frequency variation with Drive Level	$\frac{\Delta f}{f}$	Not applicable		$10^{-6}$	
12	Resistance variation with Drive Level	$\frac{\Delta R}{R}$	Not applicable		%	
13	Motional Inductance	$L_1$	Not applicable		mH	
14	Motional Capacitance	$C_1$	Not applicable		fF	
15	Static Capacitance	$C_o$	-	7.0	pF	
16	Q Factor	Q	Not applicable		-	
17	Ratio of Unwanted: Response Resistance to Resonance Resistance or Response Impedance to Resonance Resistance	$R_p/R$ $ Z_{pl}/R$	2:1	-		In the frequency range: $f_r - 50\text{kHz}$ to $f_r + 50\text{kHz}$
18	Ageing	$\frac{\Delta f}{f}$	-3.0	+3.0	$10^{-6}$	After burn-in, and per year
19	Terminal Length	L	Figure 2		mm	



**TABLE 1(a) - TYPE VARIANT DETAILED INFORMATION**

TYPE VARIANT NO. 06

No.	Characteristics	Symbol	Limits		Unit	Remarks
			Min.	Max.		
1	Resonance Frequency	$f_r$	83.335		MHz	Swept
2	Reference Temperature	$T_o$	+23	+27	°C	
3	Overtone Order	-	5			
4	Load Capacitance	$C_L$	$\infty$		pF	
5	Rated Drive Level	$P_o$	0.1		mW	
6	Frequency Adjustment Tolerance	$\frac{\Delta f}{f}$	-5.0	+5.0	$10^{-6}$	At $T_o$ °C
7	Resonance Resistance	$R_r$	-	60	$\Omega$	At $T_o$ °C
8	Frequency Variation with Temperature over $T_{op}$	$\frac{\Delta f}{f}$	-7.0	+7.0	$10^{-6}$	From frequency measured at $T_o$ °C
9	Resistance Variation with Temperature over $T_{op}$	$\frac{\Delta R}{R}$	-20	+20	%	From resistance measured at $T_o$ °C
10	Operating Temperature Range	$T_{op}$	-20	+70	°C	
11	Frequency variation with Drive Level	$\frac{\Delta f}{f}$	Not applicable		$10^{-6}$	
12	Resistance variation with Drive Level	$\frac{\Delta R}{R}$	Not applicable		%	
13	Motional Inductance	$L_1$	10.8	13.2	mH	
14	Motional Capacitance	$C_1$	Not applicable		fF	
15	Static Capacitance	$C_o$	-	7.0	pF	
16	Q Factor	Q	Not applicable		-	
17	Ratio of Unwanted: Response Resistance to Resonance Resistance or Response Impedance to Resonance Resistance	$R_p/R$ or $ Z_p /R$	2:1	-		In the frequency range: $f_r - 50\text{kHz}$ to $f_r + 50\text{kHz}$
18	Ageing	$\frac{\Delta f}{f}$	-5.0	+5.0	$10^{-6}$	After burn-in, and per year
19	Terminal Length	L	Figure 2		mm	



**TABLE 1(a) - TYPE VARIANT DETAILED INFORMATION**

TYPE VARIANT NO. 07

No.	Characteristics	Symbol	Limits		Unit	Remarks
			Min.	Max.		
1	Resonance Frequency	$f_r$	84.210526		MHz	Swept
2	Reference Temperature	$T_o$	+24	+26	°C	
3	Overtone Order	-	3			
4	Load Capacitance	$C_L$	$\infty$		pF	
5	Rated Drive Level	$P_o$	0.1		mW	
6	Frequency Adjustment Tolerance	$\frac{\Delta f}{f}$	-5.0	+5.0	$10^{-6}$	At $T_o$ °C
7	Resonance Resistance	$R_r$	-	40	$\Omega$	At $T_o$ °C
8	Frequency Variation with Temperature over $T_{op}$	$\frac{\Delta f}{f}$	-8.0	+8.0	$10^{-6}$	From frequency measured at $T_o$ °C
9	Resistance Variation with Temperature over $T_{op}$	$\frac{\Delta R}{R}$	-20	+20	%	From resistance measured at $T_o$ °C
10	Operating Temperature Range	$T_{op}$	-20	+70	°C	
11	Frequency variation with Drive Level	$\frac{\Delta f}{f}$	Not applicable		$10^{-6}$	
12	Resistance variation with Drive Level	$\frac{\Delta R}{R}$	Not applicable		%	
13	Motional Inductance	$L_1$	Not applicable		mH	
14	Motional Capacitance	$C_1$	Not applicable		fF	
15	Static Capacitance	$C_o$	-	7.0	pF	
16	Q Factor	Q	Not applicable		-	
17	Ratio of Unwanted: Response Resistance to Resonance Resistance or Response Impedance to Resonance Resistance	$R_p/R$ $ Z_p /R$	2:1	-		In the frequency range: $f_r - 50\text{kHz}$ to $f_r + 50\text{kHz}$
18	Ageing	$\frac{\Delta f}{f}$	-3.0	+3.0	$10^{-6}$	After burn-in, and per year
19	Terminal Length	L	Figure 2		mm	



**TABLE 1(a) - TYPE VARIANT DETAILED INFORMATION**

TYPE VARIANT NO. 08

No.	Characteristics	Symbol	Limits		Unit	Remarks
			Min.	Max.		
1	Resonance Frequency	$f_r$	84.868421		MHz	Swept
2	Reference Temperature	$T_o$	+24	+26	°C	
3	Overtone Order	-	3			
4	Load Capacitance	$C_L$	$\infty$		pF	
5	Rated Drive Level	$P_o$	0.1		mW	
6	Frequency Adjustment Tolerance	$\frac{\Delta f}{f}$	-5.0	+5.0	$10^{-6}$	At $T_o$ °C
7	Resonance Resistance	$R_r$	-	40	$\Omega$	At $T_o$ °C
8	Frequency Variation with Temperature over $T_{op}$	$\frac{\Delta f}{f}$	-8.0	+8.0	$10^{-6}$	From frequency measured at $T_o$ °C
9	Resistance Variation with Temperature over $T_{op}$	$\frac{\Delta R}{R}$	-20	+20	%	From resistance measured at $T_o$ °C
10	Operating Temperature Range	$T_{op}$	-20	+70	°C	
11	Frequency variation with Drive Level	$\frac{\Delta f}{f}$	Not applicable		$10^{-6}$	
12	Resistance variation with Drive Level	$\frac{\Delta R}{R}$	Not applicable		%	
13	Motional Inductance	$L_1$	Not applicable		mH	
14	Motional Capacitance	$C_1$	Not applicable		fF	
15	Static Capacitance	$C_o$	-	7.0	pF	
16	Q Factor	Q	Not applicable		-	
17	Ratio of Unwanted: Response Resistance to Resonance Resistance or Response Impedance to Resonance Resistance	$R_p/R$ or $ Z_p /R$	2:1	-		In the frequency range: $f_r - 50\text{kHz}$ to $f_r + 50\text{kHz}$
18	Ageing	$\frac{\Delta f}{f}$	-3.0	+3.0	$10^{-6}$	After burn-in, over 10 years
19	Terminal Length	L	Figure 2		mm	



**TABLE 1(a) - TYPE VARIANT DETAILED INFORMATION**

TYPE VARIANT NO. 09

No.	Characteristics	Symbol	Limits		Unit	Remarks
			Min.	Max.		
1	Resonance Frequency	$f_r$	85.087737		MHz	Swept
2	Reference Temperature	$T_o$	+24	+26	°C	
3	Overtone Order	-	3			
4	Load Capacitance	$C_L$	$\infty$		pF	
5	Rated Drive Level	$P_o$	0.1		mW	
6	Frequency Adjustment Tolerance	$\frac{\Delta f}{f}$	-5.0	+5.0	$10^{-6}$	At $T_o$ °C
7	Resonance Resistance	$R_r$	-	40	$\Omega$	At $T_o$ °C
8	Frequency Variation with Temperature over $T_{op}$	$\frac{\Delta f}{f}$	-8.0	+8.0	$10^{-6}$	From frequency measured at $T_o$ °C
9	Resistance Variation with Temperature over $T_{op}$	$\frac{\Delta R}{R}$	-20	+20	%	From resistance measured at $T_o$ °C
10	Operating Temperature Range	$T_{op}$	-20	+70	°C	
11	Frequency variation with Drive Level	$\frac{\Delta f}{f}$	Not applicable		$10^{-6}$	
12	Resistance variation with Drive Level	$\frac{\Delta R}{R}$	Not applicable		%	
13	Motional Inductance	$L_1$	Not applicable		mH	
14	Motional Capacitance	$C_1$	Not applicable		fF	
15	Static Capacitance	$C_o$	-	7.0	pF	
16	Q Factor	Q	Not applicable		-	
17	Ratio of Unwanted: Response Resistance to Resonance Resistance or Response Impedance to Resonance Resistance	$R_p/R$ $ Z_p /R$	2:1	-		In the frequency range: $f_r - 50\text{kHz}$ to $f_r + 50\text{kHz}$
18	Ageing	$\frac{\Delta f}{f}$	-3.0	+3.0	$10^{-6}$	After burn-in, and per year
19	Terminal Length	L	Figure 2		mm	



**TABLE 1(a) - TYPE VARIANT DETAILED INFORMATION**

**TYPE VARIANT NO. 10**

No.	Characteristics	Symbol	Limits		Unit	Remarks
			Min.	Max.		
1	Resonance Frequency	$f_r$	85.964947		MHz	Swept
2	Reference Temperature	$T_o$	+24	+26	°C	
3	Overtone Order	-	3			
4	Load Capacitance	$C_L$	$\infty$		pF	
5	Rated Drive Level	$P_o$	0.1		mW	
6	Frequency Adjustment Tolerance	$\frac{\Delta f}{f}$	-5.0	+5.0	$10^{-6}$	At $T_o$ °C
7	Resonance Resistance	$R_r$	-	40	$\Omega$	At $T_o$ °C
8	Frequency Variation with Temperature over $T_{op}$	$\frac{\Delta f}{f}$	-8.0	+8.0	$10^{-6}$	From frequency measured at $T_o$ °C
9	Resistance Variation with Temperature over $T_{op}$	$\frac{\Delta R}{R}$	-20	+20	%	From resistance measured at $T_o$ °C
10	Operating Temperature Range	$T_{op}$	-20	+70	°C	
11	Frequency variation with Drive Level	$\frac{\Delta f}{f}$	Not applicable		$10^{-6}$	
12	Resistance variation with Drive Level	$\frac{\Delta R}{R}$	Not applicable		%	
13	Motional Inductance	$L_1$	Not applicable		mH	
14	Motional Capacitance	$C_1$	Not applicable		fF	
15	Static Capacitance	$C_o$	-	7.0	pF	
16	Q Factor	Q	Not applicable		-	
17	Ratio of Unwanted: Response Resistance to Resonance Resistance or Response Impedance to Resonance Resistance	$R_p/R$ or $ Z_p /R$	2:1	-		In the frequency range: $f_r - 50\text{kHz}$ to $f_r + 50\text{kHz}$
18	Ageing	$\frac{\Delta f}{f}$	-3.0	+3.0	$10^{-6}$	After burn-in, and per year
19	Terminal Length	L	Figure 2		mm	





**TABLE 1(a) - TYPE VARIANT DETAILED INFORMATION**

TYPE VARIANT NO. 11

No.	Characteristics	Symbol	Limits		Unit	Remarks
			Min.	Max.		
1	Resonance Frequency	$f_r$	36.866968		MHz	Swept
2	Reference Temperature	$T_o$	+23	+27	°C	
3	Overtone Order	-	3			
4	Load Capacitance	$C_L$	$\infty$		pF	
5	Rated Drive Level	$P_o$	0.1		mW	
6	Frequency Adjustment Tolerance	$\frac{\Delta f}{f}$	-10	+10	$10^{-6}$	At $T_o$ °C
7	Resonance Resistance	$R_r$	-	40	$\Omega$	At $T_o$ °C
8	Frequency Variation with Temperature over $T_{op}$	$\frac{\Delta f}{f}$	-9.0	+9.0	$10^{-6}$	From frequency measured at $T_o$ °C
9	Resistance Variation with Temperature over $T_{op}$	$\frac{\Delta R}{R}$	-10	+10	%	From resistance measured at $T_o$ °C
10	Operating Temperature Range	$T_{op}$	-20	+70	°C	
11	Frequency variation with Drive Level	$\frac{\Delta f}{f}$	Not applicable		$10^{-6}$	
12	Resistance variation with Drive Level	$\frac{\Delta R}{R}$	Not applicable		%	
13	Motional Inductance	$L_1$	17.7	21.7	mH	
14	Motional Capacitance	$C_1$	Not applicable		fF	
15	Static Capacitance	$C_o$	-	7.0	pF	
16	Q Factor	Q	Not applicable		-	
17	Ratio of Unwanted: Response Resistance to Resonance Resistance or Response Impedance to Resonance Resistance	$R_p/R$ $ Z_p /R$	2:1	-		In the frequency range: $f_r - 50\text{kHz}$ to $f_r + 50\text{kHz}$
18	Ageing	$\frac{\Delta f}{f}$	-3.0	+3.0	$10^{-6}$	After burn-in, and per year
19	Terminal Length	L	Figure 2		mm	



**TABLE 1(a) - TYPE VARIANT DETAILED INFORMATION**

**TYPE VARIANT NO. 12**

No.	Characteristics	Symbol	Limits		Unit	Remarks
			Min.	Max.		
1	Resonance Frequency	$f_r$	37.166667		MHz	Swept
2	Reference Temperature	$T_o$	+23	+27	°C	
3	Overtone Order	-	3			
4	Load Capacitance	$C_L$	$\infty$		pF	
5	Rated Drive Level	$P_o$	0.1		mW	
6	Frequency Adjustment Tolerance	$\frac{\Delta f}{f}$	-10	+10	$10^{-6}$	At $T_o$ °C
7	Resonance Resistance	$R_r$	-	40	$\Omega$	At $T_o$ °C
8	Frequency Variation with Temperature over $T_{op}$	$\frac{\Delta f}{f}$	-9.0	+9.0	$10^{-6}$	From frequency measured at $T_o$ °C
9	Resistance Variation with Temperature over $T_{op}$	$\frac{\Delta R}{R}$	-10	+10	%	From resistance measured at $T_o$ °C
10	Operating Temperature Range	$T_{op}$	-20	+70	°C	
11	Frequency variation with Drive Level	$\frac{\Delta f}{f}$	Not applicable		$10^{-6}$	
12	Resistance variation with Drive Level	$\frac{\Delta R}{R}$	Not applicable		%	
13	Motional Inductance	$L_1$	17.3	21.3	mH	
14	Motional Capacitance	$C_1$	Not applicable		fF	
15	Static Capacitance	$C_o$	-	7.0	pF	
16	Q Factor	Q	Not applicable		-	
17	Ratio of Unwanted: Response Resistance to Resonance Resistance or Response Impedance to Resonance Resistance	$R_p/R$ or $ Z_p /R$	2:1	-		In the frequency range: $f_r - 50\text{kHz}$ to $f_r + 50\text{kHz}$
18	Ageing	$\frac{\Delta f}{f}$	-3.0	+3.0	$10^{-6}$	After burn-in, and per year
19	Terminal Length	L	Figure 2		mm	



**TABLE 1(a) - TYPE VARIANT DETAILED INFORMATION**

TYPE VARIANT NO. 13

No.	Characteristics	Symbol	Limits		Unit	Remarks
			Min.	Max.		
1	Resonance Frequency	$f_r$	62.052865		MHz	Swept
2	Reference Temperature	$T_o$	+ 23	+ 27	°C	
3	Overtone Order	-	3			
4	Load Capacitance	$C_L$	$\infty$		pF	
5	Rated Drive Level	$P_o$	0.1		mW	
6	Frequency Adjustment Tolerance	$\frac{\Delta f}{f}$	-10	+ 10	$10^{-6}$	At $T_o$ °C
7	Resonance Resistance	$R_r$	-	40	$\Omega$	At $T_o$ °C
8	Frequency Variation with Temperature over $T_{op}$	$\frac{\Delta f}{f}$	-9.0	+ 9.0	$10^{-6}$	From frequency measured at $T_o$ °C
9	Resistance Variation with Temperature over $T_{op}$	$\frac{\Delta R}{R}$	-10	+ 10	%	From resistance measured at $T_o$ °C
10	Operating Temperature Range	$T_{op}$	-20	+ 70	°C	
11	Frequency variation with Drive Level	$\frac{\Delta f}{f}$	Not applicable		$10^{-6}$	
12	Resistance variation with Drive Level	$\frac{\Delta R}{R}$	Not applicable		%	
13	Motional Inductance	$L_1$	3.2	4.8	mH	
14	Motional Capacitance	$C_1$	Not applicable		fF	
15	Static Capacitance	$C_o$	-	7.0	pF	
16	Q Factor	Q	30 000	-	-	
17	Ratio of Unwanted: Response Resistance to Resonance Resistance or Response Impedance to Resonance Resistance	$R_p/R$ or $ Z_p /R$	2:1	-		In the frequency range: $f_r - 50\text{kHz}$ to $f_r + 50\text{kHz}$
18	Ageing	$\frac{\Delta f}{f}$	-3.0	+ 3.0	$10^{-6}$	After burn-in, and per year
19	Terminal Length	L	Figure 2		mm	



**TABLE 1(a) - TYPE VARIANT DETAILED INFORMATION**

TYPE VARIANT NO. 14

No.	Characteristics	Symbol	Limits		Unit	Remarks
			Min.	Max.		
1	Resonance Frequency	$f_r$	70.0		MHz	
2	Reference Temperature	$T_o$	+23	+27	°C	
3	Overtone Order	-	3			
4	Load Capacitance	$C_L$	$\infty$		pF	
5	Rated Drive Level	$P_o$	0.1		mW	
6	Frequency Adjustment Tolerance	$\frac{\Delta f}{f}$	-10	+10	$10^{-6}$	At $T_o$ °C
7	Resonance Resistance	$R_r$	-	40	$\Omega$	At $T_o$ °C
8	Frequency Variation with Temperature over $T_{op}$	$\frac{\Delta f}{f}$	-9.0	+9.0	$10^{-6}$	From frequency measured at $T_o$ °C
9	Resistance Variation with Temperature over $T_{op}$	$\frac{\Delta R}{R}$	-10	+10	%	From resistance measured at $T_o$ °C
10	Operating Temperature Range	$T_{op}$	-20	+70	°C	
11	Frequency variation with Drive Level	$\frac{\Delta f}{f}$	Not applicable		$10^{-6}$	
12	Resistance variation with Drive Level	$\frac{\Delta R}{R}$	Not applicable		%	
13	Motional Inductance	$L_1$	3.2	4.8	mH	
14	Motional Capacitance	$C_1$	Not applicable		fF	
15	Static Capacitance	$C_o$	-	7.0	pF	
16	Q Factor	Q	35 000	-	-	
17	Ratio of Unwanted: Response Resistance to Resonance Resistance or Response Impedance to Resonance Resistance	$R_p/R$ $ Z_p /R$	2:1	-		In the frequency range: $f_r - 50\text{kHz}$ to $f_r + 50\text{kHz}$
18	Ageing	$\frac{\Delta f}{f}$	-3.0	+3.0	$10^{-6}$	After burn-in, and per year
19	Terminal Length	L	Figure 2		mm	

**TABLE 1(a) - TYPE VARIANT DETAILED INFORMATION**TYPE VARIANT NO. 15

No.	Characteristics	Symbol	Limits		Unit	Remarks
			Min.	Max.		
1	Resonance Frequency	$f_L$	102.0833333		MHz	
2	Reference Temperature	$T_o$	+22	+28	°C	
3	Overtone Order	-	5			
4	Load Capacitance	$C_L$	11.9	12.1	pF	
5	Rated Drive Level	$P_o$	0.1		mW	
6	Frequency Adjustment Tolerance	$\frac{\Delta f}{f}$	-5.0	+5.0	10 <sup>-6</sup>	At $T_o$ °C
7	Resonance Resistance	$R_L$	-	70	Ω	Over $T_{op}$ °C
8	Frequency Variation with Temperature over $T_{op}$	$\frac{\Delta f}{f}$	-5.0	+5.0	10 <sup>-6</sup>	From frequency measured at $T_o$ °C
9	Resistance Variation with Temperature over $T_{op}$	$\frac{\Delta R}{R}$	Not applicable		%	
10	Operating Temperature Range	$T_{op}$	-20	+50	°C	
11	Frequency variation with Drive Level	$\frac{\Delta f}{f}$	Not applicable		10 <sup>-6</sup>	
12	Resistance variation with Drive Level	$\frac{\Delta R}{R}$	Not applicable		%	
13	Motional Inductance	$L_1$	Not applicable		mH	
14	Motional Capacitance	$C_1$	-	0.37	fF	
15	Static Capacitance	$C_o$	-	3.0	pF	
16	Q Factor	Q	60 000	-	-	
17	Ratio of Unwanted: Response Resistance to Resonance Resistance or Response Impedance to Resonance Resistance	$R_p/R$ or $ Z_p /R$	3:1	-		In the frequency range: $f_L - 100\text{kHz}$ to $f_L + 100\text{kHz}$
18	Ageing	$\frac{\Delta f}{f}$	-10	+10	10 <sup>-6</sup>	After burn-in, over 10 years
19	Terminal Length	L	Figure 2		mm	



**TABLE 1(a) - TYPE VARIANT DETAILED INFORMATION**

TYPE VARIANT NO. 16

No.	Characteristics	Symbol	Limits		Unit	Remarks
			Min.	Max.		
1	Resonance Frequency	$f_L$	15.0		MHz	
2	Reference Temperature	$T_o$	+ 40		°C	
3	Overtone Order	-	Fundamental			
4	Load Capacitance	$C_L$	50		pF	
5	Rated Drive Level	$P_o$	0.1		mW	
6	Frequency Adjustment Tolerance	$\frac{\Delta f}{f}$	-10	+ 10	$10^{-6}$	At $T_o$ °C
7	Resonance Resistance	$R_L$	-	13	$\Omega$	Over $T_{op}$ °C
8	Frequency Variation with Temperature over $T_{op}$	$\frac{\Delta f}{f}$	-15	+ 15	$10^{-6}$	From frequency measured at $T_o$ °C
9	Resistance Variation with Temperature over $T_{op}$	$\frac{\Delta R}{R}$	Not applicable		%	
10	Operating Temperature Range	$T_{op}$	-20	+ 80	°C	
11	Frequency variation with Drive Level	$\frac{\Delta f}{f}$	Not applicable		$10^{-6}$	
12	Resistance variation with Drive Level	$\frac{\Delta R}{R}$	Not applicable		%	
13	Motional Inductance	$L_1$	Not applicable		mH	
14	Motional Capacitance	$C_1$	Not applicable		fF	
15	Static Capacitance	$C_o$	Not applicable		pF	
16	Q Factor	Q	50 000	-	-	
17	Ratio of Unwanted: Response Resistance to Resonance Resistance or Response Impedance to Resonance Resistance	$R_p/R$ or $iZ_p/R$	3:1	-		In the frequency range: $f_L - 200\text{kHz}$ to $f_L + 200\text{kHz}$
18	Ageing	$\frac{\Delta f}{f}$	-3.0	+ 3.0	$10^{-6}$	
19	Terminal Length	L	Figure 2		mm	



**TABLE 1(a) - TYPE VARIANT DETAILED INFORMATION**

TYPE VARIANT NO. 17

No.	Characteristics	Symbol	Limits		Unit	Remarks
			Min.	Max.		
1	Resonance Frequency	$f_L$	16.0		MHz	
2	Reference Temperature	$T_o$	+60		°C	
3	Overtone Order	-	Fundamental			
4	Load Capacitance	$C_L$	20	50	pF	
5	Rated Drive Level	$P_o$	0.1		mW	
6	Frequency Adjustment Tolerance	$\frac{\Delta f}{f}$	-10	+10	$10^{-6}$	At $T_o$ °C
7	Resonance Resistance	$R_L$	-	20	$\Omega$	At $T_o$ °C
8	Frequency Variation with Temperature over $T_{op}$	$\frac{\Delta f}{f}$	-10	+10	$10^{-6}$	From frequency measured at $T_o$ °C
9	Resistance Variation with Temperature over $T_{op}$	$\frac{\Delta R}{R}$	-10	+10	%	From resistance measured at $T_o$ °C If $R < 10\Omega$
			-1.5	+1.5	$\Omega$	
10	Operating Temperature Range	$T_{op}$	-30	+70	°C	
11	Frequency variation with Drive Level	$\frac{\Delta f}{f}$	Not applicable		$10^{-6}$	
12	Resistance variation with Drive Level	$\frac{\Delta R}{R}$	Not applicable		%	
13	Motional Inductance	$L_1$	9.5		mH	
14	Motional Capacitance	$C_1$	Not applicable		fF	
15	Static Capacitance	$C_o$	-	7.0	pF	
16	Q Factor	Q	70 000	-	-	
17	Ratio of Unwanted: Response Resistance to Resonance Resistance or Response Impedance to Resonance Resistance	$R_p/R$ $iZ_p/R$	2:1	-		In the frequency range: $f_L - 200\text{kHz}$ to $f_L + 200\text{kHz}$
18	Ageing	$\frac{\Delta f}{f}$	-10	+10	$10^{-6}$	After burn-in, and per year
19	Terminal Length	L	Figure 2		mm	



**TABLE 1(a) - TYPE VARIANT DETAILED INFORMATION**

**TYPE VARIANT NO. 18**

No.	Characteristics	Symbol	Limits		Unit	Remarks
			Min.	Max.		
1	Resonance Frequency	$f_L$	15.84		MHz	
2	Reference Temperature	$T_0$	+ 25		°C	
3	Overtone Order	-	Fundamental			
4	Load Capacitance	$C_L$	50		pF	
5	Rated Drive Level	$P_0$	0.1		mW	
6	Frequency Adjustment Tolerance	$\frac{\Delta f}{f}$	-20	+ 20	$10^{-6}$	At $T_0$ °C
7	Resonance Resistance	$R_L$	-	20	$\Omega$	Over $T_{op}$ °C
8	Frequency Variation with Temperature over $T_{op}$	$\frac{\Delta f}{f}$	-30	+ 30	$10^{-6}$	From frequency measured at $T_0$ °C
9	Resistance Variation with Temperature over $T_{op}$	$\frac{\Delta R}{R}$	Not applicable		%	
10	Operating Temperature Range	$T_{op}$	-55	+ 105	°C	
11	Frequency variation with Drive Level	$\frac{\Delta f}{f}$	Not applicable		$10^{-6}$	
12	Resistance variation with Drive Level	$\frac{\Delta R}{R}$	Not applicable		%	
13	Motional Inductance	$L_1$	12.24	16.56	mH	
14	Motional Capacitance	$C_1$	Not applicable		fF	
15	Static Capacitance	$C_0$	-	5.0	pF	
16	Q Factor	Q	70 000	-	-	
17	Ratio of Unwanted: Response Resistance to Resonance Resistance or Response Impedance to Resonance Resistance	$R_p/R$ or $ Z_p /R$	3:1	-		In the frequency range: $f_L - 1.0\text{MHz}$ to $f_L + 1.0\text{MHz}$
18	Ageing	$\frac{\Delta f}{f}$	-7.5	+ 7.5	$10^{-6}$	After burn-in, and per year
19	Terminal Length	L	Figure 2		mm	





**TABLE 1(a) - TYPE VARIANT DETAILED INFORMATION**

TYPE VARIANT NO. 19

No.	Characteristics	Symbol	Limits		Unit	Remarks
			Min.	Max.		
1	Resonance Frequency	$f_L$	16.0 -16.384		MHz	
2	Reference Temperature	$T_o$	+60		°C	
3	Overtone Order	-	Fundamental			
4	Load Capacitance	$C_L$	22		pF	
5	Rated Drive Level	$P_o$	0.1		mW	
6	Frequency Adjustment Tolerance	$\frac{\Delta f}{f}$	-10	+10	$10^{-6}$	At $T_o$ °C
7	Resonance Resistance	$R_L$	-	20	$\Omega$	Over $T_{op}$ °C
8	Frequency Variation with Temperature over $T_{op}$	$\frac{\Delta f}{f}$	-15	+15	$10^{-6}$	From frequency measured at $T_o$ °C
9	Resistance Variation with Temperature over $T_{op}$	$\frac{\Delta R}{R}$	Not applicable		%	
10	Operating Temperature Range	$T_{op}$	-20	+70	°C	
11	Frequency variation with Drive Level	$\frac{\Delta f}{f}$	Not applicable		$10^{-6}$	
12	Resistance variation with Drive Level	$\frac{\Delta R}{R}$	Not applicable		%	
13	Motional Inductance	$L_1$	Not applicable		mH	
14	Motional Capacitance	$C_1$	Not applicable		fF	
15	Static Capacitance	$C_o$	-	5.0	pF	
16	Q Factor	Q	Not applicable		-	
17	Ratio of Unwanted: Response Resistance to Resonance Resistance or Response Impedance to Resonance Resistance	$R_p/R$ or $ Z_p /R$	3:1	-		In the frequency range: $f_L$ -200kHz to $f_L$ +200kHz
18	Ageing	$\frac{\Delta f}{f}$	-3.0	+3.0	$10^{-6}$	After burn-in, and per year
19	Terminal Length	L	Figure 2		mm	



**TABLE 1(a) - TYPE VARIANT DETAILED INFORMATION**

TYPE VARIANT NO. 20

No.	Characteristics	Symbol	Limits		Unit	Remarks
			Min.	Max.		
1	Resonance Frequency	$f_L$	16.35		MHz	
2	Reference Temperature	$T_o$	+ 25		°C	
3	Overtone Order	-	Fundamental			
4	Load Capacitance	$C_L$	30		pF	
5	Rated Drive Level	$P_o$	0.1		mW	
6	Frequency Adjustment Tolerance	$\frac{\Delta f}{f}$	-15	+ 15	$10^{-6}$	At $T_o$ °C
7	Resonance Resistance	$R_L$	-	30	$\Omega$	Over $T_{op}$ °C
8	Frequency Variation with Temperature over $T_{op}$	$\frac{\Delta f}{f}$	-15	+ 15	$10^{-6}$	From frequency measured at $T_o$ °C
9	Resistance Variation with Temperature over $T_{op}$	$\frac{\Delta R}{R}$	Not applicable		%	
10	Operating Temperature Range	$T_{op}$	-20	+ 70	°C	
11	Frequency variation with Drive Level	$\frac{\Delta f}{f}$	Not applicable		$10^{-6}$	
12	Resistance variation with Drive Level	$\frac{\Delta R}{R}$	Not applicable		%	
13	Motional Inductance	$L_1$	Not applicable		mH	
14	Motional Capacitance	$C_1$	Not applicable		fF	
15	Static Capacitance	$C_o$	-	4.0	pF	
16	Q Factor	Q	Not applicable		-	
17	Ratio of Unwanted: Response Resistance to Resonance Resistance or Response Impedance to Resonance Resistance	$R_p/R$ $ Z_p /R$	2:1	-		In the frequency range: $f_L - 1.0\text{MHz}$ to $f_L + 1.0\text{MHz}$
18	Ageing	$\frac{\Delta f}{f}$	-5.0	+ 5.0	$10^{-6}$	After burn-in, and per year
19	Terminal Length	L	Figure 2		mm	



**TABLE 1(a) - TYPE VARIANT DETAILED INFORMATION**

TYPE VARIANT NO. 21

No.	Characteristics	Symbol	Limits		Unit	Remarks
			Min.	Max.		
1	Resonance Frequency	$f_r$	18.84		MHz	
2	Reference Temperature	$T_o$	+25		°C	
3	Overtone Order	-	Fundamental			
4	Load Capacitance	$C_L$	$\infty$		pF	
5	Rated Drive Level	$P_o$	0.1		mW	
6	Frequency Adjustment Tolerance	$\frac{\Delta f}{f}$	-5.0	+5.0	$10^{-6}$	At $T_o$ °C
7	Resonance Resistance	$R_r$	-	17.5	$\Omega$	At $T_o$ °C
8	Frequency Variation with Temperature over $T_{op}$	$\frac{\Delta f}{f}$	-7.0	+7.0	$10^{-6}$	From frequency measured at $T_o$ °C
9	Resistance Variation with Temperature over $T_{op}$	$\Delta R$	-2.0	+2.0	$\Omega$	From resistance measured at $T_o$ °C
10	Operating Temperature Range	$T_{op}$	-20	+55	°C	
11	Frequency variation with Drive Level	$\frac{\Delta f}{f}$	Not applicable		$10^{-6}$	
12	Resistance variation with Drive Level	$\frac{\Delta R}{R}$	Not applicable		%	
13	Motional Inductance	$L_1$	8.1	9.9	mH	
14	Motional Capacitance	$C_1$	Not applicable		fF	
15	Static Capacitance	$C_o$	-	4.0	pF	
16	Q Factor	Q	70 000	-	-	
17	Ratio of Unwanted: Response Resistance to Resonance Resistance or Response Impedance to Resonance Resistance	$R_p/R$ or $ Z_p /R$	3:1	-		In the frequency range: $f_r - 200\text{kHz}$ to $f_r + 200\text{kHz}$
18	Ageing	$\frac{\Delta f}{f}$	-5.0	+5.0	$10^{-6}$	After burn-in, and over 3 years
19	Terminal Length	L	Figure 2		mm	



**TABLE 1(a) - TYPE VARIANT DETAILED INFORMATION**

**TYPE VARIANT NO. 22**

No.	Characteristics	Symbol	Limits		Unit	Remarks
			Min.	Max.		
1	Resonance Frequency	$f_L$	18.84		MHz	
2	Reference Temperature	$T_o$	+25		°C	
3	Overtone Order	-	Fundamental			
4	Load Capacitance	$C_L$	32		pF	
5	Rated Drive Level	$P_o$	0.1		mW	
6	Frequency Adjustment Tolerance	$\frac{\Delta f}{f}$	-5.0	+5.0	$10^{-6}$	At $T_o$ °C
7	Resonance Resistance	$R_L$	-	26	$\Omega$	At $T_o$ °C
8	Frequency Variation with Temperature over $T_{op}$	$\frac{\Delta f}{f}$	-7.0	+7.0	$10^{-6}$	From frequency measured at $T_o$ °C
9	Resistance Variation with Temperature over $T_{op}$	$\Delta R$	-2.0	+2.0	$\Omega$	From resistance measured at $T_o$ °C
10	Operating Temperature Range	$T_{op}$	-20	+55	°C	
11	Frequency variation with Drive Level	$\frac{\Delta f}{f}$	Not applicable		$10^{-6}$	
12	Resistance variation with Drive Level	$\frac{\Delta R}{R}$	Not applicable		%	
13	Motional Inductance	$L_1$	13.68	16.72	mH	
14	Motional Capacitance	$C_1$	Not applicable		fF	
15	Static Capacitance	$C_o$	-	3.0	pF	
16	Q Factor	Q	80 000	-	-	
17	Ratio of Unwanted: Response Resistance to Resonance Resistance or Response Impedance to Resonance Resistance	$R_p/R$ or $ Z_p /R$	3:1	-		In the frequency range: $f_L - 500\text{kHz}$ to $f_L + 500\text{kHz}$
18	Ageing	$\frac{\Delta f}{f}$	-5.0	+5.0	$10^{-6}$	
19	Terminal Length	L	Figure 2		mm	



**TABLE 1(a) - TYPE VARIANT DETAILED INFORMATION**

**TYPE VARIANT NO. 23**

No.	Characteristics	Symbol	Limits		Unit	Remarks
			Min.	Max.		
1	Resonance Frequency	$f_L$	15.0		MHz	
2	Reference Temperature	$T_0$	+25		°C	
3	Overtone Order	-	Fundamental			
4	Load Capacitance	$C_L$	31	33	pF	
5	Rated Drive Level	$P_0$	0.1		mW	
6	Frequency Adjustment Tolerance	$\frac{\Delta f}{f}$	-10	+10	$10^{-6}$	At $T_0$ °C
7	Resonance Resistance	$R_L$	-	20	$\Omega$	At $T_0$ °C
8	Frequency Variation with Temperature over $T_{op}$	$\frac{\Delta f}{f}$	-20	+20	$10^{-6}$	From frequency measured at $T_0$ °C
9	Resistance Variation with Temperature over $T_{op}$	$\frac{\Delta R}{R}$	-10 or -1.5	+10 +1.5	% $\Omega$	From resistance measured at $T_0$ °C If $R < 10\Omega$
10	Operating Temperature Range	$T_{op}$	-30	+70	°C	
11	Frequency variation with Drive Level	$\frac{\Delta f}{f}$	Not applicable		$10^{-6}$	
12	Resistance variation with Drive Level	$\frac{\Delta R}{R}$	Not applicable		%	
13	Motional Inductance	$L_1$	8.8	12	mH	
14	Motional Capacitance	$C_1$	Not applicable		fF	
15	Static Capacitance	$C_0$	-	7.0	pF	
16	Q Factor	Q	80 000	-	-	
17	Ratio of Unwanted: Response Resistance to Resonance Resistance or Response Impedance to Resonance Resistance	$R_p/R$ or $ Z_p /R$	Not applicable			
18	Ageing	$\frac{\Delta f}{f}$	-10	+10	$10^{-6}$	After burn-in, and per year
19	Terminal Length	L	Figure 2		mm	



**TABLE 1(a) - TYPE VARIANT DETAILED INFORMATION**

TYPE VARIANT NO. 24

No.	Characteristics	Symbol	Limits		Unit	Remarks
			Min.	Max.		
1	Resonance Frequency	$f_L$	20.0		MHz	
2	Reference Temperature	$T_o$	+ 59	+ 61	°C	
3	Overtone Order	-	Fundamental			
4	Load Capacitance	$C_L$	22		pF	
5	Rated Drive Level	$P_o$	0.1		mW	
6	Frequency Adjustment Tolerance	$\frac{\Delta f}{f}$	-10	+ 10	$10^{-6}$	At $T_o$ °C
7	Resonance Resistance	$R_L$	-	20	$\Omega$	Over $T_{op}$ °C
8	Frequency Variation with Temperature over $T_{op}$	$\frac{\Delta f}{f}$	-15	+ 15	$10^{-6}$	From frequency measured at $T_o$ °C
9	Resistance Variation with Temperature over $T_{op}$	$\frac{\Delta R}{R}$	Not applicable		%	
10	Operating Temperature Range	$T_{op}$	-20	+ 70	°C	
11	Frequency variation with Drive Level	$\frac{\Delta f}{f}$	Not applicable		$10^{-6}$	
12	Resistance variation with Drive Level	$\frac{\Delta R}{R}$	Not applicable		%	
13	Motional Inductance	$L_1$	Not applicable		mH	
14	Motional Capacitance	$C_1$	Not applicable		fF	
15	Static Capacitance	$C_o$	-	4.5	pF	
16	Q Factor	Q	50 000	-	-	
17	Ratio of Unwanted: Response Resistance to Resonance Resistance or Response Impedance to Resonance Resistance	$R_p/R$ $ Z_{pl}/R$	3:1	-		In the frequency range: $f_L - 200\text{kHz}$ to $f_L + 200\text{kHz}$
18	Ageing	$\frac{\Delta f}{f}$	-3.0	+ 3.0	$10^{-6}$	After burn-in, and per year
19	Terminal Length	L	Figure 2		mm	



**TABLE 1(a) - TYPE VARIANT DETAILED INFORMATION**

TYPE VARIANT NO. 25

No.	Characteristics	Symbol	Limits		Unit	Remarks
			Min.	Max.		
1	Resonance Frequency	$f_r$	36.693333		MHz	
2	Reference Temperature	$T_o$	+23	+27	°C	
3	Overtone Order	-	3			
4	Load Capacitance	$C_L$	$\infty$		pF	
5	Rated Drive Level	$P_o$	0.1		mW	
6	Frequency Adjustment Tolerance	$\frac{\Delta f}{f}$	-10	+10	$10^{-6}$	At $T_o$ °C
7	Resonance Resistance	$R_r$	-	40	$\Omega$	At $T_o$ °C
8	Frequency Variation with Temperature over $T_{op}$	$\frac{\Delta f}{f}$	-9.0	+9.0	$10^{-6}$	From frequency measured at $T_o$ °C
9	Resistance Variation with Temperature over $T_{op}$	$\frac{\Delta R}{R}$	-10	+10	%	From resistance measured at $T_o$ °C
10	Operating Temperature Range	$T_{op}$	-20	+70	°C	
11	Frequency variation with Drive Level	$\frac{\Delta f}{f}$	Not applicable		$10^{-6}$	
12	Resistance variation with Drive Level	$\frac{\Delta R}{R}$	Not applicable		%	
13	Motional Inductance	$L_1$	17.7	21.7	mH	
14	Motional Capacitance	$C_1$	Not applicable		fF	
15	Static Capacitance	$C_o$	-	7.0	pF	
16	Q Factor	Q	19 000	-	-	
17	Ratio of Unwanted: Response Resistance to Resonance Resistance or Response Impedance to Resonance Resistance	$R_p/R$ or $ Z_p /R$	2:1	-		In the frequency range: $f_r - 50\text{kHz}$ to $f_r + 50\text{kHz}$
18	Ageing	$\frac{\Delta f}{f}$	-3.0	+3.0	$10^{-6}$	After burn-in, and per year
19	Terminal Length	L	Figure 2		mm	



**TABLE 1(a) - TYPE VARIANT DETAILED INFORMATION**

**TYPE VARIANT NO. 26**

No.	Characteristics	Symbol	Limits		Unit	Remarks
			Min.	Max.		
1	Resonance Frequency	$f_L$	20.8333		MHz	
2	Reference Temperature	$T_o$	+ 25		°C	
3	Overtone Order	-	Fundamental			
4	Load Capacitance	$C_L$	10		pF	
5	Rated Drive Level	$P_o$	0.1		mW	
6	Frequency Adjustment Tolerance	$\frac{\Delta f}{f}$	-10	+ 10	$10^{-6}$	At $T_o$ °C
7	Resonance Resistance	$R_L$	-	20	$\Omega$	Over $T_{op}$ °C
8	Frequency Variation with Temperature over $T_{op}$	$\frac{\Delta f}{f}$	-10	+ 10	$10^{-6}$	From frequency measured at $T_o$ °C
9	Resistance Variation with Temperature over $T_{op}$	$\frac{\Delta R}{R}$	Not applicable		%	
10	Operating Temperature Range	$T_{op}$	-10	+ 60	°C	
11	Frequency variation with Drive Level	$\frac{\Delta f}{f}$	Not applicable		$10^{-6}$	
12	Resistance variation with Drive Level	$\frac{\Delta R}{R}$	Not applicable		%	
13	Motional Inductance	$L_1$	Not applicable		mH	
14	Motional Capacitance	$C_1$	Not applicable		fF	
15	Static Capacitance	$C_o$	Not applicable		pF	
16	Q Factor	Q	Not applicable		-	
17	Ratio of Unwanted: Response Resistance to Resonance Resistance or Response Impedance to Resonance Resistance	$R_p/R$ or $ Z_p /R$	4:1	-		In the frequency range: $f_L - 10\%$ to $f_L + 10\%$
18	Ageing	$\frac{\Delta f}{f}$	Not applicable		$10^{-6}$	
19	Terminal Length	L	Figure 2		mm	





**TABLE 1(a) - TYPE VARIANT DETAILED INFORMATION**

TYPE VARIANT NO. 27

No.	Characteristics	Symbol	Limits		Unit	Remarks
			Min.	Max.		
1	Resonance Frequency	$f_L$	22.841667		MHz	
2	Reference Temperature	$T_o$	+ 25		°C	
3	Overtone Order	-	Fundamental			
4	Load Capacitance	$C_L$	30		pF	
5	Rated Drive Level	$P_o$	0.1		mW	
6	Frequency Adjustment Tolerance	$\frac{\Delta f}{f}$	-10	+ 10	$10^{-6}$	At $T_o$ °C
7	Resonance Resistance	$R_L$	-	15	$\Omega$	Over $T_{op}$ °C
8	Frequency Variation with Temperature over $T_{op}$	$\frac{\Delta f}{f}$	-10	+ 10	$10^{-6}$	From frequency measured at $T_o$ °C
9	Resistance Variation with Temperature over $T_{op}$	$\frac{\Delta R}{R}$	Not applicable		%	
10	Operating Temperature Range	$T_{op}$	-25	+ 65	°C	
11	Frequency variation with Drive Level	$\frac{\Delta f}{f}$	Not applicable		$10^{-6}$	
12	Resistance variation with Drive Level	$\frac{\Delta R}{R}$	Not applicable		%	
13	Motional Inductance	$L_1$	Not applicable		mH	
14	Motional Capacitance	$C_1$	Not applicable		fF	
15	Static Capacitance	$C_o$	-	3.0	pF	
16	Q Factor	Q	Not applicable		-	
17	Ratio of Unwanted: Response Resistance to Resonance Resistance or Response Impedance to Resonance Resistance	$R_p/R$   $Z_p$  /R	3:1	-		In the frequency range: $f_L - 200\text{kHz}$ to $f_L + 200\text{kHz}$
18	Ageing	$\frac{\Delta f}{f}$	Not applicable		$10^{-6}$	
19	Terminal Length	L	Figure 2		mm	



**TABLE 1(a) - TYPE VARIANT DETAILED INFORMATION**

**TYPE VARIANT NO. 28**

No.	Characteristics	Symbol	Limits		Unit	Remarks
			Min.	Max.		
1	Resonance Frequency	$f_L$	22.856667		MHz	
2	Reference Temperature	$T_o$	+25		°C	
3	Overtone Order	-	Fundamental			
4	Load Capacitance	$C_L$	22	56	pF	
5	Rated Drive Level	$P_o$	0.1		mW	
6	Frequency Adjustment Tolerance	$\frac{\Delta f}{f}$	Not applicable		$10^{-6}$	
7	Resonance Resistance	$R_L$	-	40	$\Omega$	Over $T_{op}$ °C
8	Frequency Variation with Temperature over $T_{op}$	$\frac{\Delta f}{f}$	-7.0	+7.0	$10^{-6}$	From frequency measured at $T_o$ °C
9	Resistance Variation with Temperature over $T_{op}$	$\frac{\Delta R}{R}$	Not applicable		%	
10	Operating Temperature Range	$T_{op}$	-20	+50	°C	
11	Frequency variation with Drive Level	$\frac{\Delta f}{f}$	Not applicable		$10^{-6}$	
12	Resistance variation with Drive Level	$\frac{\Delta R}{R}$	Not applicable		%	
13	Motional Inductance	$L_1$	Not applicable		mH	
14	Motional Capacitance	$C_1$	Not applicable		fF	
15	Static Capacitance	$C_o$	Not applicable		pF	
16	Q Factor	Q	80 000	-	-	
17	Ratio of Unwanted: Response Resistance to Resonance Resistance or Response Impedance to Resonance Resistance	$R_p/R$ or $ Z_p /R$	3:1	-		In the frequency range: $f_L - 200\text{kHz}$ to $f_L + 200\text{kHz}$
18	Ageing	$\frac{\Delta f}{f}$	-10	+10	$10^{-6}$	After burn-in, over 8 years
19	Terminal Length	L	Figure 2		mm	



**TABLE 1(a) - TYPE VARIANT DETAILED INFORMATION**

TYPE VARIANT NO. 29

No.	Characteristics	Symbol	Limits		Unit	Remarks
			Min.	Max.		
1	Resonance Frequency	$f_L$	22.861667		MHz	
2	Reference Temperature	$T_o$	+ 25		°C	
3	Overtone Order	-	Fundamental			
4	Load Capacitance	$C_L$	30		pF	
5	Rated Drive Level	$P_o$	0.1		mW	
6	Frequency Adjustment Tolerance	$\frac{\Delta f}{f}$	-10	+ 10	$10^{-6}$	At $T_o$ °C
7	Resonance Resistance	$R_L$	-	15	$\Omega$	Over $T_{op}$ °C
8	Frequency Variation with Temperature over $T_{op}$	$\frac{\Delta f}{f}$	-10	+ 10	$10^{-6}$	From frequency measured at $T_o$ °C
9	Resistance Variation with Temperature over $T_{op}$	$\frac{\Delta R}{R}$	Not applicable		%	
10	Operating Temperature Range	$T_{op}$	-20	+ 65	°C	
11	Frequency variation with Drive Level	$\frac{\Delta f}{f}$	Not applicable		$10^{-6}$	
12	Resistance variation with Drive Level	$\frac{\Delta R}{R}$	Not applicable		%	
13	Motional Inductance	$L_1$	Not applicable		mH	
14	Motional Capacitance	$C_1$	Not applicable		fF	
15	Static Capacitance	$C_o$	-	4.0	pF	
16	Q Factor	Q	Not applicable		-	
17	Ratio of Unwanted: Response Resistance to Resonance Resistance or Response Impedance to Resonance Resistance	$R_p/R$ or $ Z_p /R$	3:1	-		In the frequency range: $f_L - 200\text{kHz}$ to $f_L + 200\text{kHz}$
18	Ageing	$\frac{\Delta f}{f}$	Not applicable		$10^{-6}$	
19	Terminal Length	L	Figure 2		mm	



**TABLE 1(a) - TYPE VARIANT DETAILED INFORMATION**

TYPE VARIANT NO. 30

No.	Characteristics	Symbol	Limits		Unit	Remarks
			Min.	Max.		
1	Resonance Frequency	$f_L$	24.184		MHz	
2	Reference Temperature	$T_o$	+25		°C	
3	Overtone Order	-	Fundamental			
4	Load Capacitance	$C_L$	32		pF	
5	Rated Drive Level	$P_o$	0.1		mW	
6	Frequency Adjustment Tolerance	$\frac{\Delta f}{f}$	-5.0	+5.0	$10^{-6}$	At $T_o$ °C
7	Resonance Resistance	$R_L$	-	26	$\Omega$	Over $T_{op}$ °C
8	Frequency Variation with Temperature over $T_{op}$	$\frac{\Delta f}{f}$	-10	+10	$10^{-6}$	From frequency measured at $T_o$ °C
9	Resistance Variation with Temperature over $T_{op}$	$\frac{\Delta R}{R}$	Not applicable		%	
10	Operating Temperature Range	$T_{op}$	-10	+50	°C	
11	Frequency variation with Drive Level	$\frac{\Delta f}{f}$	Not applicable		$10^{-6}$	
12	Resistance variation with Drive Level	$\frac{\Delta R}{R}$	Not applicable		%	
13	Motional Inductance	$L_1$	Not applicable		mH	
14	Motional Capacitance	$C_1$	Not applicable		fF	
15	Static Capacitance	$C_o$	-	3.5	pF	
16	Q Factor	Q	50 000	-	-	
17	Ratio of Unwanted: Response Resistance to Resonance Resistance or Response Impedance to Resonance Resistance	$R_p/R$ or $ Z_p /R$	10:1	-		In the frequency range: $f_L - 2.0\text{MHz}$ to $f_L + 2.0\text{MHz}$
18	Ageing	$\frac{\Delta f}{f}$	-5.0	+5.0	$10^{-6}$	After burn-in, and per year
19	Terminal Length	L	Figure 2		mm	



**TABLE 1(a) - TYPE VARIANT DETAILED INFORMATION**

TYPE VARIANT NO. 31

No.	Characteristics	Symbol	Limits		Unit	Remarks
			Min.	Max.		
1	Resonance Frequency	$f_L$	24.5		MHz	
2	Reference Temperature	$T_o$	+25		°C	
3	Overtone Order	-	Fundamental			
4	Load Capacitance	$C_L$	30		pF	
5	Rated Drive Level	$P_o$	0.1		mW	
6	Frequency Adjustment Tolerance	$\frac{\Delta f}{f}$	-5.0	+5.0	$10^{-6}$	At $T_o$ °C
7	Resonance Resistance	$R_L$	-	25	$\Omega$	Over $T_{op}$ °C
8	Frequency Variation with Temperature over $T_{op}$	$\frac{\Delta f}{f}$	-7.0	+7.0	$10^{-6}$	From frequency measured at $T_o$ °C
9	Resistance Variation with Temperature over $T_{op}$	$\frac{\Delta R}{R}$	Not applicable		%	
10	Operating Temperature Range	$T_{op}$	-20	+60	°C	
11	Frequency variation with Drive Level	$\frac{\Delta f}{f}$	Not applicable		$10^{-6}$	
12	Resistance variation with Drive Level	$\frac{\Delta R}{R}$	Not applicable		%	
13	Motional Inductance	$L_1$	Not applicable		mH	
14	Motional Capacitance	$C_1$	Not applicable		fF	
15	Static Capacitance	$C_o$	-	5.0	pF	
16	Q Factor	Q	80 000	-	-	
17	Ratio of Unwanted: Response Resistance to Resonance Resistance or Response Impedance to Resonance Resistance	$R_p/R$ or $ Z_p /R$	3:1	-		In the frequency range: $f_L - 200\text{kHz}$ to $f_L + 200\text{kHz}$
18	Ageing	$\frac{\Delta f}{f}$	-5.0	+5.0	$10^{-6}$	After burn-in, and per year
19	Terminal Length	L	Figure 2		mm	



**TABLE 1(a) - TYPE VARIANT DETAILED INFORMATION**

**TYPE VARIANT NO. 32**

No.	Characteristics	Symbol	Limits		Unit	Remarks
			Min.	Max.		
1	Resonance Frequency	$f_L$	24.5		MHz	
2	Reference Temperature	$T_0$	+25		°C	
3	Overtone Order	-	Fundamental			
4	Load Capacitance	$C_L$	32		pF	
5	Rated Drive Level	$P_0$	0.1		mW	
6	Frequency Adjustment Tolerance	$\frac{\Delta f}{f}$	-5.0	+5.0	$10^{-6}$	At $T_0$ °C
7	Resonance Resistance	$R_L$	-	21	$\Omega$	At $T_0$ °C
8	Frequency Variation with Temperature over $T_{op}$	$\frac{\Delta f}{f}$	-7.0	+7.0	$10^{-6}$	From frequency measured at $T_0$ °C
9	Resistance Variation with Temperature over $T_{op}$	$\Delta R$	-2.0	+2.0	$\Omega$	From resistance measured at $T_0$ °C
10	Operating Temperature Range	$T_{op}$	-20	+55	°C	
11	Frequency variation with Drive Level	$\frac{\Delta f}{f}$	Not applicable		$10^{-6}$	
12	Resistance variation with Drive Level	$\frac{\Delta R}{R}$	Not applicable		%	
13	Motional Inductance	$L_1$	6.23	7.62	mH	
14	Motional Capacitance	$C_1$	Not applicable		fF	
15	Static Capacitance	$C_0$	-	3.0	pF	
16	Q Factor	Q	80 000	-	-	
17	Ratio of Unwanted: Response Resistance to Resonance Resistance or Response Impedance to Resonance Resistance	$R_p/R$ or $ Z_{pl}/R$	3:1	-		In the frequency range: $f_L - 500\text{kHz}$ to $f_L + 500\text{kHz}$
18	Ageing	$\frac{\Delta f}{f}$	-5.0	+5.0	$10^{-6}$	After burn-in, and over 3 years
19	Terminal Length	L	Figure 2		mm	



**TABLE 1(a) - TYPE VARIANT DETAILED INFORMATION**

**TYPE VARIANT NO. 33**

No.	Characteristics	Symbol	Limits		Unit	Remarks
			Min.	Max.		
1	Resonance Frequency	$f_r$	36.666 -38.333		MHz	
2	Reference Temperature	$T_o$	+25		°C	
3	Overtone Order	-	3			
4	Load Capacitance	$C_L$	$\infty$		pF	
5	Rated Drive Level	$P_o$	0.1		mW	
6	Frequency Adjustment Tolerance	$\frac{\Delta f}{f}$	-5.0	+5.0	$10^{-6}$	At $T_o$ °C
7	Resonance Resistance	$R_r$	-	40	$\Omega$	Over $T_{op}$ °C
8	Frequency Variation with Temperature over $T_{op}$	$\frac{\Delta f}{f}$	-7.0	+7.0	$10^{-6}$	From frequency measured at $T_o$ °C
9	Resistance Variation with Temperature over $T_{op}$	$\frac{\Delta R}{R}$	Not applicable		%	
10	Operating Temperature Range	$T_{op}$	-20	+60	°C	
11	Frequency variation with Drive Level	$\frac{\Delta f}{f}$	Not applicable		$10^{-6}$	
12	Resistance variation with Drive Level	$\frac{\Delta R}{R}$	Not applicable		%	
13	Motional Inductance	$L_1$	Not applicable		mH	
14	Motional Capacitance	$C_1$	Not applicable		fF	
15	Static Capacitance	$C_o$	-	5.0	pF	
16	Q Factor	Q	Not applicable		-	
17	Ratio of Unwanted: Response Resistance to Resonance Resistance or Response Impedance to Resonance Resistance	$R_p/R$ or $ Z_p /R$	3:1	-		In the frequency range: $f_r - 50\text{kHz}$ to $f_r + 50\text{kHz}$
18	Ageing	$\frac{\Delta f}{f}$	-3.0	+3.0	$10^{-6}$	After burn-in, and per year
19	Terminal Length	L	Figure 2		mm	



**TABLE 1(a) - TYPE VARIANT DETAILED INFORMATION**

TYPE VARIANT NO. 34

No.	Characteristics	Symbol	Limits		Unit	Remarks
			Min.	Max.		
1	Resonance Frequency	$f_L$	38.25618		MHz	
2	Reference Temperature	$T_o$	+22		°C	
3	Overtone Order	-	3			
4	Load Capacitance	$C_L$	10	100	pF	
5	Rated Drive Level	$P_o$	0.1		mW	
6	Frequency Adjustment Tolerance	$\frac{\Delta f}{f}$	-8.0	+8.0	10 <sup>-6</sup>	At $T_o$ °C
7	Resonance Resistance	$R_L$	-	75	Ω	Over $T_{op}$ °C
8	Frequency Variation with Temperature over $T_{op}$	$\frac{\Delta f}{f}$	-4.0	+4.0	10 <sup>-6</sup>	From frequency measured at $T_o$ °C
9	Resistance Variation with Temperature over $T_{op}$	$\frac{\Delta R}{R}$	Not applicable		%	
10	Operating Temperature Range	$T_{op}$	0	+40	°C	
11	Frequency variation with Drive Level	$\frac{\Delta f}{f}$	Not applicable		10 <sup>-6</sup>	
12	Resistance variation with Drive Level	$\frac{\Delta R}{R}$	Not applicable		%	
13	Motional Inductance	$L_1$	Not applicable		mH	
14	Motional Capacitance	$C_1$	Not applicable		fF	
15	Static Capacitance	$C_o$	-	2.0	pF	
16	Q Factor	Q	200 000	-	-	
17	Ratio of Unwanted: Response Resistance to Resonance Resistance or Response Impedance to Resonance Resistance	$R_p/R$ $ Z_p /R$	3:1	-		In the frequency range: $f_L - 1.0\text{MHz}$ to $f_L + 1.0\text{MHz}$
18	Ageing	$\frac{\Delta f}{f}$	-2.0	+2.0	10 <sup>-6</sup>	Per year
19	Terminal Length	L	Figure 2		mm	





**TABLE 1(a) - TYPE VARIANT DETAILED INFORMATION**

TYPE VARIANT NO. 35

No.	Characteristics	Symbol	Limits		Unit	Remarks
			Min.	Max.		
1	Resonance Frequency	$f_L$	55.46875		MHz	
2	Reference Temperature	$T_o$	+45		°C	
3	Overtone Order	-	3			
4	Load Capacitance	$C_L$	20		pF	
5	Rated Drive Level	$P_o$	0.1		mW	
6	Frequency Adjustment Tolerance	$\frac{\Delta f}{f}$	-5.0	+5.0	10 <sup>-6</sup>	At $T_o$ °C
7	Resonance Resistance	$R_L$	-	40	Ω	Over $T_{op}$ °C
8	Frequency Variation with Temperature over $T_{op}$	$\frac{\Delta f}{f}$	-0.4	+0.4	10 <sup>-6</sup>	From frequency measured at $T_o$ °C
9	Resistance Variation with Temperature over $T_{op}$	$\frac{\Delta R}{R}$	Not applicable		%	
10	Operating Temperature Range	$T_{op}$	-43	+47	°C	
11	Frequency variation with Drive Level	$\frac{\Delta f}{f}$	Not applicable		10 <sup>-6</sup>	
12	Resistance variation with Drive Level	$\frac{\Delta R}{R}$	Not applicable		%	
13	Motional Inductance	$L_1$	Not applicable		mH	
14	Motional Capacitance	$C_1$	Not applicable		fF	
15	Static Capacitance	$C_o$	2.5	3.5	pF	
16	Q Factor	Q	100 000	-	-	
17	Ratio of Unwanted: Response Resistance to Resonance Resistance or Response Impedance to Resonance Resistance	$R_p/R$ $ Z_p /R$	10:1	-		In the frequency range: $f_L - 50kHz$ to $f_L + 50kHz$
18	Ageing	$\frac{\Delta f}{f}$	-1.5	+1.5	10 <sup>-6</sup>	Per year after burn-in
19	Terminal Length	L	Figure 2		mm	



**TABLE 1(a) - TYPE VARIANT DETAILED INFORMATION**

**TYPE VARIANT NO. 36**

No.	Characteristics	Symbol	Limits		Unit	Remarks
			Min.	Max.		
1	Resonance Frequency	$f_L$	62.5 -68.125		MHz	
2	Reference Temperature	$T_o$	+ 25		°C	
3	Overtone Order	-	3			
4	Load Capacitance	$C_L$	10		pF	
5	Rated Drive Level	$P_o$	0.1		mW	
6	Frequency Adjustment Tolerance	$\frac{\Delta f}{f}$	-10	+ 10	$10^{-6}$	At $T_o$ °C
7	Resonance Resistance	$R_L$	-	40	$\Omega$	Over $T_{op}$ °C
8	Frequency Variation with Temperature over $T_{op}$	$\frac{\Delta f}{f}$	-10	+ 10	$10^{-6}$	From frequency measured at $T_o$ °C
9	Resistance Variation with Temperature over $T_{op}$	$\frac{\Delta R}{R}$	Not applicable		%	
10	Operating Temperature Range	$T_{op}$	-10	+ 60	°C	
11	Frequency variation with Drive Level	$\frac{\Delta f}{f}$	Not applicable		$10^{-6}$	
12	Resistance variation with Drive Level	$\frac{\Delta R}{R}$	Not applicable		%	
13	Motional Inductance	$L_1$	Not applicable		mH	
14	Motional Capacitance	$C_1$	Not applicable		fF	
15	Static Capacitance	$C_o$	Not applicable		pF	
16	Q Factor	Q	Not applicable		-	
17	Ratio of Unwanted: Response Resistance to Resonance Resistance or Response Impedance to Resonance Resistance	$R_p/R$ $ Z_p /R$	4:1	-		In the frequency range: $f_L - 10\%$ to $f_L + 10\%$
18	Ageing	$\frac{\Delta f}{f}$	Not applicable		$10^{-6}$	
19	Terminal Length	L	Figure 2		mm	



**TABLE 1(a) - TYPE VARIANT DETAILED INFORMATION**

TYPE VARIANT NO. 37

No.	Characteristics	Symbol	Limits		Unit	Remarks
			Min.	Max.		
1	Resonance Frequency	$f_L$	71.859475		MHz	
2	Reference Temperature	$T_o$	+25		°C	
3	Overtone Order	-	5			
4	Load Capacitance	$C_L$	15	100	pF	
5	Rated Drive Level	$P_o$	0.1		mW	
6	Frequency Adjustment Tolerance	$\frac{\Delta f}{f}$	-2.0	+2.0	$10^{-6}$	At $T_o$ °C
7	Resonance Resistance	$R_L$	70	130	$\Omega$	Over $T_{op}$ °C
8	Frequency Variation with Temperature over $T_{op}$	$\frac{\Delta f}{f}$	-7.0	+7.0	$10^{-6}$	From frequency measured at $T_o$ °C
9	Resistance Variation with Temperature over $T_{op}$	$\frac{\Delta R}{R}$	Not applicable		%	
10	Operating Temperature Range	$T_{op}$	-20	+50	°C	
11	Frequency variation with Drive Level	$\frac{\Delta f}{f}$	Not applicable		$10^{-6}$	
12	Resistance variation with Drive Level	$\frac{\Delta R}{R}$	Not applicable		%	
13	Motional Inductance	$L_1$	Not applicable		mH	
14	Motional Capacitance	$C_1$	Not applicable		fF	
15	Static Capacitance	$C_o$	-	2.0	pF	
16	Q Factor	Q	100 000	-	-	
17	Ratio of Unwanted: Response Resistance to Resonance Resistance or Response Impedance to Resonance Resistance	$R_p/R$ or $ Z_p /R$	3:1	-		In the frequency range: $f_L - 50\text{kHz}$ to $f_L + 50\text{kHz}$
18	Ageing	$\frac{\Delta f}{f}$	-2.0	+2.0	$10^{-6}$	After burn-in, and per year
19	Terminal Length	L	Figure 2		mm	



**TABLE 1(a) - TYPE VARIANT DETAILED INFORMATION**

TYPE VARIANT NO. 38

No.	Characteristics	Symbol	Limits		Unit	Remarks
			Min.	Max.		
1	Resonance Frequency	$f_L$	75.36015		MHz	
2	Reference Temperature	$T_o$	+25		°C	
3	Overtone Order	-	5			
4	Load Capacitance	$C_L$	15	100	pF	
5	Rated Drive Level	$P_o$	0.1		mW	
6	Frequency Adjustment Tolerance	$\frac{\Delta f}{f}$	-2.0	+2.0	$10^{-6}$	At $T_o$ °C
7	Resonance Resistance	$R_L$	70	130	$\Omega$	Over $T_{op}$ °C
8	Frequency Variation with Temperature over $T_{op}$	$\frac{\Delta f}{f}$	-7.0	+7.0	$10^{-6}$	From frequency measured at $T_o$ °C
9	Resistance Variation with Temperature over $T_{op}$	$\frac{\Delta R}{R}$	Not applicable		%	
10	Operating Temperature Range	$T_{op}$	-20	+50	°C	
11	Frequency variation with Drive Level	$\frac{\Delta f}{f}$	Not applicable		$10^{-6}$	
12	Resistance variation with Drive Level	$\frac{\Delta R}{R}$	Not applicable		%	
13	Motional Inductance	$L_1$	Not applicable		mH	
14	Motional Capacitance	$C_1$	Not applicable		fF	
15	Static Capacitance	$C_o$	-	2.0	pF	
16	Q Factor	Q	100 000	-	-	
17	Ratio of Unwanted: Response Resistance to Resonance Resistance or Response Impedance to Resonance Resistance	$R_p/R$ or $ Z_p /R$	3:1	-		In the frequency range: $f_L - 50\text{kHz}$ to $f_L + 50\text{kHz}$
18	Ageing	$\frac{\Delta f}{f}$	-2.0	+2.0	$10^{-6}$	After burn-in, and per year
19	Terminal Length	L	Figure 2		mm	



**TABLE 1(a) - TYPE VARIANT DETAILED INFORMATION**

TYPE VARIANT NO. 39

No.	Characteristics	Symbol	Limits		Unit	Remarks
			Min.	Max.		
1	Resonance Frequency	$f_L$	79.516319		MHz	
2	Reference Temperature	$T_o$	+ 30		°C	
3	Overtone Order	-	3			
4	Load Capacitance	$C_L$	20	33	pF	
5	Rated Drive Level	$P_o$	0.1		mW	
6	Frequency Adjustment Tolerance	$\frac{\Delta f}{f}$	Not applicable		$10^{-6}$	
7	Resonance Resistance	$R_L$	-	50	$\Omega$	Over $T_{op}$ °C
8	Frequency Variation with Temperature over $T_{op}$	$\frac{\Delta f}{f}$	-10	+ 10	$10^{-6}$	From frequency measured at $T_o$ °C
9	Resistance Variation with Temperature over $T_{op}$	$\frac{\Delta R}{R}$	Not applicable		%	
10	Operating Temperature Range	$T_{op}$	-10	+ 70	°C	
11	Frequency variation with Drive Level	$\frac{\Delta f}{f}$	Not applicable		$10^{-6}$	
12	Resistance variation with Drive Level	$\frac{\Delta R}{R}$	Not applicable		%	
13	Motional Inductance	$L_1$	Not applicable		mH	
14	Motional Capacitance	$C_1$	Not applicable		fF	
15	Static Capacitance	$C_o$	-	4.0	pF	
16	Q Factor	Q	Not applicable		-	
17	Ratio of Unwanted: Response Resistance to Resonance Resistance or Response Impedance to Resonance Resistance	$R_p/R$ or $ Z_p /R$	3:1	-		In the frequency range: $f_L - 50\text{kHz}$ to $f_L + 50\text{kHz}$
18	Ageing	$\frac{\Delta f}{f}$	-5.0	+ 5.0	$10^{-6}$	After burn-in, over 3 years
19	Terminal Length	L	Figure 2		mm	



**TABLE 1(a) - TYPE VARIANT DETAILED INFORMATION**

TYPE VARIANT NO. 40

No.	Characteristics	Symbol	Limits		Unit	Remarks
			Min.	Max.		
1	Resonance Frequency	$f_L$	80.381944		MHz	
2	Reference Temperature	$T_o$	+25		°C	
3	Overtone Order	-	3			
4	Load Capacitance	$C_L$	21.6	31.4	pF	
5	Rated Drive Level	$P_o$	0.1		mW	
6	Frequency Adjustment Tolerance	$\frac{\Delta f}{f}$	Not applicable		$10^{-6}$	
7	Resonance Resistance	$R_L$	-	50	$\Omega$	Over $T_{op}$ °C
8	Frequency Variation with Temperature over $T_{op}$	$\frac{\Delta f}{f}$	-10	+10	$10^{-6}$	From frequency measured at $T_o$ °C
9	Resistance Variation with Temperature over $T_{op}$	$\frac{\Delta R}{R}$	Not applicable		%	
10	Operating Temperature Range	$T_{op}$	-25	+65	°C	
11	Frequency variation with Drive Level	$\frac{\Delta f}{f}$	Not applicable		$10^{-6}$	
12	Resistance variation with Drive Level	$\frac{\Delta R}{R}$	Not applicable		%	
13	Motional Inductance	$L_1$	Not applicable		mH	
14	Motional Capacitance	$C_1$	Not applicable		fF	
15	Static Capacitance	$C_o$	-3.6	4.4	pF	
16	Q Factor	Q	Not applicable		-	
17	Ratio of Unwanted: Response Resistance to Resonance Resistance or Response Impedance to Resonance Resistance	$R_p/R$ or $ Z_p /R$	2:1	-		In the frequency range: $f_L - 50\text{kHz}$ to $f_L + 50\text{kHz}$
18	Ageing	$\frac{\Delta f}{f}$	Not applicable		$10^{-6}$	
19	Terminal Length	L	Figure 2		mm	



**TABLE 1(a) - TYPE VARIANT DETAILED INFORMATION**

TYPE VARIANT NO. 41

No.	Characteristics	Symbol	Limits		Unit	Remarks
			Min.	Max.		
1	Resonance Frequency	$f_L$	81.847222		MHz	
2	Reference Temperature	$T_o$	+25		°C	
3	Overtone Order	-	3			
4	Load Capacitance	$C_L$	20	33	pF	
5	Rated Drive Level	$P_o$	0.1		mW	
6	Frequency Adjustment Tolerance	$\frac{\Delta f}{f}$	Not applicable		$10^{-6}$	
7	Resonance Resistance	$R_L$	Not applicable		$\Omega$	
8	Frequency Variation with Temperature over $T_{op}$	$\frac{\Delta f}{f}$	-10	+10	$10^{-6}$	From frequency measured at $T_o$ °C
9	Resistance Variation with Temperature over $T_{op}$	$\frac{\Delta R}{R}$	Not applicable		%	
10	Operating Temperature Range	$T_{op}$	-25	+65	°C	
11	Frequency variation with Drive Level	$\frac{\Delta f}{f}$	Not applicable		$10^{-6}$	
12	Resistance variation with Drive Level	$\frac{\Delta R}{R}$	Not applicable		%	
13	Motional Inductance	$L_1$	Not applicable		mH	
14	Motional Capacitance	$C_1$	Not applicable		fF	
15	Static Capacitance	$C_o$	Not applicable		pF	
16	Q Factor	Q	Not applicable		-	
17	Ratio of Unwanted: Response Resistance to Resonance Resistance or Response Impedance to Resonance Resistance	$R_p/R$ or $ Z_p /R$	Not applicable			
18	Ageing	$\frac{\Delta f}{f}$	Not applicable		$10^{-6}$	
19	Terminal Length	L	Figure 2		mm	



**TABLE 1(a) - TYPE VARIANT DETAILED INFORMATION**

TYPE VARIANT NO. 42

No.	Characteristics	Symbol	Limits		Unit	Remarks
			Min.	Max.		
1	Resonance Frequency	$f_r$	99.1		MHz	
2	Reference Temperature	$T_o$	+ 25		°C	
3	Overtone Order	-	5			
4	Load Capacitance	$C_L$	$\infty$		pF	
5	Rated Drive Level	$P_o$	0.1		mW	
6	Frequency Adjustment Tolerance	$\frac{\Delta f}{f}$	-5.0	+ 5.0	$10^{-6}$	At $T_o$ °C
7	Resonance Resistance	$R_r$	-	50	$\Omega$	At $T_o$ °C
8	Frequency Variation with Temperature over $T_{op}$	$\frac{\Delta f}{f}$	-5.0	+ 5.0	$10^{-6}$	From frequency measured at $T_o$ °C
9	Resistance Variation with Temperature over $T_{op}$	$\frac{\Delta R}{R}$	-10	+ 10	%	From resistance measured at $T_o$ °C
10	Operating Temperature Range	$T_{op}$	-20	+ 60	°C	
11	Frequency variation with Drive Level	$\frac{\Delta f}{f}$	Not applicable		$10^{-6}$	
12	Resistance variation with Drive Level	$\frac{\Delta R}{R}$	Not applicable		%	
13	Motional Inductance	$L_1$	Not applicable		mH	
14	Motional Capacitance	$C_1$	Not applicable		fF	
15	Static Capacitance	$C_o$	-	3.5	pF	
16	Q Factor	Q	Not applicable		-	
17	Ratio of Unwanted: Response Resistance to Resonance Resistance or Response Impedance to Resonance Resistance	$R_p/R$ $ Z_{pl}/R$	3:1	-		In the frequency range: $f_r - 20\%$ to $f_r + 20\%$
18	Ageing	$\frac{\Delta f}{f}$	-3.0	+ 3.0	$10^{-6}$	After burn-in, over 3 years
19	Terminal Length	L	Figure 2		mm	





**TABLE 1(a) - TYPE VARIANT DETAILED INFORMATION**

**TYPE VARIANT NO. 43**

No.	Characteristics	Symbol	Limits		Unit	Remarks
			Min.	Max.		
1	Resonance Frequency	$f_L$	105.0		MHz	
2	Reference Temperature	$T_o$	+25		°C	
3	Overtone Order	-	5			
4	Load Capacitance	$C_L$	10		pF	
5	Rated Drive Level	$P_o$	0.1		mW	
6	Frequency Adjustment Tolerance	$\frac{\Delta f}{f}$	-10	+10	$10^{-6}$	At $T_o$ °C
7	Resonance Resistance	$R_L$	-	60	$\Omega$	Over $T_{op}$ °C
8	Frequency Variation with Temperature over $T_{op}$	$\frac{\Delta f}{f}$	-10	+10	$10^{-6}$	From frequency measured at $T_o$ °C
9	Resistance Variation with Temperature over $T_{op}$	$\frac{\Delta R}{R}$	Not applicable		%	
10	Operating Temperature Range	$T_{op}$	-10	+60	°C	
11	Frequency variation with Drive Level	$\frac{\Delta f}{f}$	Not applicable		$10^{-6}$	
12	Resistance variation with Drive Level	$\frac{\Delta R}{R}$	Not applicable		%	
13	Motional Inductance	$L_1$	Not applicable		mH	
14	Motional Capacitance	$C_1$	Not applicable		fF	
15	Static Capacitance	$C_o$	Not applicable		pF	
16	Q Factor	Q	Not applicable		-	
17	Ratio of Unwanted: Response Resistance to Resonance Resistance or Response Impedance to Resonance Resistance	$R_p/R$ or $ Z_p /R$	3:1	-		In the frequency range: $f_L - 10\%$ to $f_L + 10\%$
18	Ageing	$\frac{\Delta f}{f}$	Not applicable		$10^{-6}$	
19	Terminal Length	L	Figure 2		mm	



**TABLE 1(a) - TYPE VARIANT DETAILED INFORMATION**

TYPE VARIANT NO. 44

No.	Characteristics	Symbol	Limits		Unit	Remarks
			Min.	Max.		
1	Resonance Frequency	$f_r$	120.796		MHz	
2	Reference Temperature	$T_o$	+25		°C	
3	Overtone Order	-	5			
4	Load Capacitance	$C_L$	$\infty$		pF	
5	Rated Drive Level	$P_o$	0.1		mW	
6	Frequency Adjustment Tolerance	$\frac{\Delta f}{f}$	-5.0	+5.0	$10^{-6}$	At $T_o$ °C
7	Resonance Resistance	$R_r$	-	55	$\Omega$	Over $T_{op}$ °C
8	Frequency Variation with Temperature over $T_{op}$	$\frac{\Delta f}{f}$	-10	+10	$10^{-6}$	From frequency measured at $T_o$ °C
9	Resistance Variation with Temperature over $T_{op}$	$\frac{\Delta R}{R}$	Not applicable		%	
10	Operating Temperature Range	$T_{op}$	-10	+50	°C	
11	Frequency variation with Drive Level	$\frac{\Delta f}{f}$	Not applicable		$10^{-6}$	
12	Resistance variation with Drive Level	$\frac{\Delta R}{R}$	Not applicable		%	
13	Motional Inductance	$L_1$	Not applicable		mH	
14	Motional Capacitance	$C_1$	Not applicable		fF	
15	Static Capacitance	$C_o$	-	3.5	pF	
16	Q Factor	Q	70 000	-	-	
17	Ratio of Unwanted: Response Resistance to Resonance Resistance or Response Impedance to Resonance Resistance	$R_p/R$ or $ Z_{pl}/R$	Not applicable			
18	Ageing	$\frac{\Delta f}{f}$	-5.0	+5.0	$10^{-6}$	After burn-in, per year
19	Terminal Length	L	Figure 2		mm	



**TABLE 1(a) - TYPE VARIANT DETAILED INFORMATION**

**TYPE VARIANT NO. 45**

No.	Characteristics	Symbol	Limits		Unit	Remarks
			Min.	Max.		
1	Resonance Frequency	$f_r$	61.805555		MHz	$f_s = 61.8047\text{MHz}$
2	Reference Temperature	$T_o$	+23	+27	°C	
3	Overtone Order	-	3			
4	Load Capacitance	$C_L$	$\infty$		pF	
5	Rated Drive Level	$P_o$	0.1		mW	
6	Frequency Adjustment Tolerance	$\frac{\Delta f}{f}$	-5.0	+5.0	$10^{-6}$	At $T_o$ °C
7	Resonance Resistance	$R_r$	-	40	$\Omega$	At $T_o$ °C
8	Frequency Variation with Temperature over $T_{op}$	$\frac{\Delta f}{f}$	-10	+10	$10^{-6}$	From frequency measured at $T_o$ °C
9	Resistance Variation with Temperature over $T_{op}$	$\frac{\Delta R}{R}$	-20	+20	%	From resistance measured at $T_o$ °C
10	Operating Temperature Range	$T_{op}$	-20	+70	°C	
11	Frequency variation with Drive Level	$\frac{\Delta f}{f}$	Not applicable		$10^{-6}$	
12	Resistance variation with Drive Level	$\frac{\Delta R}{R}$	Not applicable		%	
13	Motional Inductance	$L_1$	Not applicable		mH	
14	Motional Capacitance	$C_1$	Not applicable		fF	
15	Static Capacitance	$C_o$	-	7.0	pF	
16	Q Factor	Q	Not applicable		-	
17	Ratio of Unwanted: Response Resistance to Resonance Resistance or Response Impedance to Resonance Resistance	$R_p/R$ or $ Z_p /R$	2:1	-		In the frequency range: $f_r - 60\text{kHz}$ to $f_r + 60\text{kHz}$
18	Ageing	$\frac{\Delta f}{f}$	-3.0	+3.0	$10^{-6}$	
19	Terminal Length	L	Figure 2		mm	



**TABLE 1(a) - TYPE VARIANT DETAILED INFORMATION**

**TYPE VARIANT NO. 46**

No.	Characteristics	Symbol	Limits		Unit	Remarks
			Min.	Max.		
1	Resonance Frequency	$f_r$	62.5		MHz	$f_s = 62.4992\text{MHz}$
2	Reference Temperature	$T_o$	+23	+27	°C	
3	Overtone Order	-	3			
4	Load Capacitance	$C_L$	$\infty$		pF	
5	Rated Drive Level	$P_o$	0.1		mW	
6	Frequency Adjustment Tolerance	$\frac{\Delta f}{f}$	-5.0	+5.0	$10^{-6}$	At $T_o$ °C
7	Resonance Resistance	$R_r$	-	40	$\Omega$	At $T_o$ °C
8	Frequency Variation with Temperature over $T_{op}$	$\frac{\Delta f}{f}$	-10	+10	$10^{-6}$	From frequency measured at $T_o$ °C
9	Resistance Variation with Temperature over $T_{op}$	$\frac{\Delta R}{R}$	-20	+20	%	From resistance measured at $T_o$ °C
10	Operating Temperature Range	$T_{op}$	-20	+70	°C	
11	Frequency variation with Drive Level	$\frac{\Delta f}{f}$	Not applicable		$10^{-6}$	
12	Resistance variation with Drive Level	$\frac{\Delta R}{R}$	Not applicable		%	
13	Motional Inductance	$L_1$	Not applicable		mH	
14	Motional Capacitance	$C_1$	Not applicable		fF	
15	Static Capacitance	$C_o$	-	7.0	pF	
16	Q Factor	Q	Not applicable		-	
17	Ratio of Unwanted: Response Resistance to Resonance Resistance or Response Impedance to Resonance Resistance	$R_p/R$ or $ Z_p /R$	2:1	-		In the frequency range: $f_r - 60\text{kHz}$ to $f_r + 60\text{kHz}$
18	Ageing	$\frac{\Delta f}{f}$	-3.0	+3.0	$10^{-6}$	After burn-in, and per year
19	Terminal Length	L	Figure 2		mm	



**TABLE 1(a) - TYPE VARIANT DETAILED INFORMATION**

TYPE VARIANT NO. 47

No.	Characteristics	Symbol	Limits		Unit	Remarks
			Min.	Max.		
1	Resonance Frequency	$f_r$	62.03125		MHz	$f_s = 62.03045\text{MHz}$
2	Reference Temperature	$T_o$	+23	+27	°C	
3	Overtone Order	-	3			
4	Load Capacitance	$C_L$	$\infty$		pF	
5	Rated Drive Level	$P_o$	0.1		mW	
6	Frequency Adjustment Tolerance	$\frac{\Delta f}{f}$	-5.0	+5.0	$10^{-6}$	At $T_o$ °C
7	Resonance Resistance	$R_r$	-	40	$\Omega$	At $T_o$ °C
8	Frequency Variation with Temperature over $T_{op}$	$\frac{\Delta f}{f}$	-10	+10	$10^{-6}$	From frequency measured at $T_o$ °C
9	Resistance Variation with Temperature over $T_{op}$	$\frac{\Delta R}{R}$	-20	+20	%	From resistance measured at $T_o$ °C
10	Operating Temperature Range	$T_{op}$	-20	+70	°C	
11	Frequency variation with Drive Level	$\frac{\Delta f}{f}$	Not applicable		$10^{-6}$	
12	Resistance variation with Drive Level	$\frac{\Delta R}{R}$	Not applicable		%	
13	Motional Inductance	$L_1$	Not applicable		mH	
14	Motional Capacitance	$C_1$	Not applicable		fF	
15	Static Capacitance	$C_o$	-	7.0	pF	
16	Q Factor	Q	Not applicable		-	
17	Ratio of Unwanted: Response Resistance to Resonance Resistance or Response Impedance to Resonance Resistance	$R_p/R$ or $ Z_p /R$	2:1	-		In the frequency range: $f_r - 60\text{kHz}$ to $f_r + 60\text{kHz}$
18	Ageing	$\frac{\Delta f}{f}$	-3.0	+3.0	$10^{-6}$	After burn-in, and per year
19	Terminal Length	L	Figure 2		mm	



**TABLE 1(a) - TYPE VARIANT DETAILED INFORMATION**

TYPE VARIANT NO. 48

No.	Characteristics	Symbol	Limits		Unit	Remarks
			Min.	Max.		
1	Resonance Frequency	$f_r$	62.109375		MHz	$f_s = 62.108575\text{MHz}$
2	Reference Temperature	$T_o$	+23	+27	°C	
3	Overtone Order	-	3			
4	Load Capacitance	$C_L$	$\infty$		pF	
5	Rated Drive Level	$P_o$	0.1		mW	
6	Frequency Adjustment Tolerance	$\frac{\Delta f}{f}$	-5.0	+5.0	$10^{-6}$	At $T_o$ °C
7	Resonance Resistance	$R_r$	-	40	$\Omega$	At $T_o$ °C
8	Frequency Variation with Temperature over $T_{op}$	$\frac{\Delta f}{f}$	-10	+10	$10^{-6}$	From frequency measured at $T_o$ °C
9	Resistance Variation with Temperature over $T_{op}$	$\frac{\Delta R}{R}$	-20	+20	%	From resistance measured at $T_o$ °C
10	Operating Temperature Range	$T_{op}$	-20	+70	°C	
11	Frequency variation with Drive Level	$\frac{\Delta f}{f}$	Not applicable		$10^{-6}$	
12	Resistance variation with Drive Level	$\frac{\Delta R}{R}$	Not applicable		%	
13	Motional Inductance	$L_1$	Not applicable		mH	
14	Motional Capacitance	$C_1$	Not applicable		fF	
15	Static Capacitance	$C_o$	-	7.0	pF	
16	Q Factor	Q	Not applicable		-	
17	Ratio of Unwanted: Response Resistance to Resonance Resistance or Response Impedance to Resonance Resistance	$R_p/R$ or $ Z_{pl}/R$	2:1	-		In the frequency range: $f_r - 60\text{kHz}$ to $f_r + 60\text{kHz}$
18	Ageing	$\frac{\Delta f}{f}$	-3.0	+3.0	$10^{-6}$	After burn-in, and per year
19	Terminal Length	L	Figure 2		mm	



**TABLE 1(a) - TYPE VARIANT DETAILED INFORMATION**

TYPE VARIANT NO. 49

No.	Characteristics	Symbol	Limits		Unit	Remarks
			Min.	Max.		
1	Resonance Frequency	$f_r$	69.559524		MHz	$f_s = 69.5587\text{MHz}$
2	Reference Temperature	$T_o$	+23	+27	°C	
3	Overtone Order	-	3			
4	Load Capacitance	$C_L$	$\infty$		pF	
5	Rated Drive Level	$P_o$	0.1		mW	
6	Frequency Adjustment Tolerance	$\frac{\Delta f}{f}$	-5.0	+5.0	$10^{-6}$	At $T_o$ °C
7	Resonance Resistance	$R_r$	-	40	$\Omega$	At $T_o$ °C
8	Frequency Variation with Temperature over $T_{op}$	$\frac{\Delta f}{f}$	-10	+10	$10^{-6}$	From frequency measured at $T_o$ °C
9	Resistance Variation with Temperature over $T_{op}$	$\frac{\Delta R}{R}$	-20	+20	%	From resistance measured at $T_o$ °C
10	Operating Temperature Range	$T_{op}$	-20	+70	°C	
11	Frequency variation with Drive Level	$\frac{\Delta f}{f}$	Not applicable		$10^{-6}$	
12	Resistance variation with Drive Level	$\frac{\Delta R}{R}$	Not applicable		%	
13	Motional Inductance	$L_1$	Not applicable		mH	
14	Motional Capacitance	$C_1$	Not applicable		fF	
15	Static Capacitance	$C_o$	-	7.0	pF	
16	Q Factor	Q	Not applicable		-	
17	Ratio of Unwanted: Response Resistance to Resonance Resistance or Response Impedance to Resonance Resistance	$R_p/R$ or $ Z_p /R$	2:1	-		In the frequency range: $f_r - 60\text{kHz}$ to $f_r + 60\text{kHz}$
18	Ageing	$\frac{\Delta f}{f}$	-3.0	+3.0	$10^{-6}$	After burn-in, and per year
19	Terminal Length	L	Figure 2		mm	



**TABLE 1(a) - TYPE VARIANT DETAILED INFORMATION**

TYPE VARIANT NO. 50

No.	Characteristics	Symbol	Limits		Unit	Remarks
			Min.	Max.		
1	Resonance Frequency	$f_r$	69.619048		MHz	$f_s = 69.6182\text{MHz}$
2	Reference Temperature	$T_o$	+23	+27	°C	
3	Overtone Order	-	3			
4	Load Capacitance	$C_L$	$\infty$		pF	
5	Rated Drive Level	$P_o$	0.1		mW	
6	Frequency Adjustment Tolerance	$\frac{\Delta f}{f}$	-5.0	+5.0	$10^{-6}$	At $T_o$ °C
7	Resonance Resistance	$R_r$	-	40	$\Omega$	At $T_o$ °C
8	Frequency Variation with Temperature over $T_{op}$	$\frac{\Delta f}{f}$	-10	+10	$10^{-6}$	From frequency measured at $T_o$ °C
9	Resistance Variation with Temperature over $T_{op}$	$\frac{\Delta R}{R}$	-20	+20	%	From resistance measured at $T_o$ °C
10	Operating Temperature Range	$T_{op}$	-20	+70	°C	
11	Frequency variation with Drive Level	$\frac{\Delta f}{f}$	Not applicable		$10^{-6}$	
12	Resistance variation with Drive Level	$\frac{\Delta R}{R}$	Not applicable		%	
13	Motional Inductance	$L_1$	Not applicable		mH	
14	Motional Capacitance	$C_1$	Not applicable		fF	
15	Static Capacitance	$C_o$	-	7.0	pF	
16	Q Factor	Q	Not applicable		-	
17	Ratio of Unwanted: Response Resistance to Resonance Resistance or Response Impedance to Resonance Resistance	$R_p/R$ or $ Z_p /R$	2:1	-		In the frequency range: $f_r - 60\text{kHz}$ to $f_r + 60\text{kHz}$
18	Ageing	$\frac{\Delta f}{f}$	-3.0	+3.0	$10^{-6}$	After burn-in, and per year
19	Terminal Length	L	Figure 2		mm	





**TABLE 1(a) - TYPE VARIANT DETAILED INFORMATION**

**TYPE VARIANT NO. 51**

No.	Characteristics	Symbol	Limits		Unit	Remarks
			Min.	Max.		
1	Resonance Frequency	$f_L$	24.68617		MHz	
2	Reference Temperature	$T_o$	+23	+27	°C	
3	Overtone Order	-	Fundamental			
4	Load Capacitance	$C_L$	30		pF	
5	Rated Drive Level	$P_o$	0.1		mW	
6	Frequency Adjustment Tolerance	$\frac{\Delta f}{f}$	-5.0	+5.0	$10^{-6}$	At $T_o$ °C
7	Resonance Resistance	$R_L$	-	25	$\Omega$	At $T_o$ °C
8	Frequency Variation with Temperature over $T_{op}$	$\frac{\Delta f}{f}$	-6.0	+6.0	$10^{-6}$	From frequency measured at $T_o$ °C
9	Resistance Variation with Temperature over $T_{op}$	$\frac{\Delta R}{R}$	-20	+20	%	From resistance measured at $T_o$ °C
10	Operating Temperature Range	$T_{op}$	-20	+70	°C	
11	Frequency variation with Drive Level	$\frac{\Delta f}{f}$	Not applicable		$10^{-6}$	
12	Resistance variation with Drive Level	$\frac{\Delta R}{R}$	Not applicable		%	
13	Motional Inductance	$L_1$	Not applicable		mH	
14	Motional Capacitance	$C_1$	Not applicable		fF	
15	Static Capacitance	$C_o$	-	7.0	pF	
16	Q Factor	Q	Not applicable		-	
17	Ratio of Unwanted: Response Resistance to Resonance Resistance or Response Impedance to Resonance Resistance	$R_p/R$ or $ Z_p /R$	2:1	-		In the frequency range: $f_L -200kHz$ to $f_L +200kHz$
18	Ageing	$\frac{\Delta f}{f}$	-3.0	+3.0	$10^{-6}$	After burn-in, and per year
19	Terminal Length	L	Figure 2		mm	



**TABLE 1(a) - TYPE VARIANT DETAILED INFORMATION**

TYPE VARIANT NO. 52

No.	Characteristics	Symbol	Limits		Unit	Remarks
			Min.	Max.		
1	Resonance Frequency	$f_r$	82.53		MHz	$f_s = 82.5292\text{MHz}$
2	Reference Temperature	$T_o$	+23	+27	°C	
3	Overtone Order	-	3			
4	Load Capacitance	$C_L$	$\infty$		pF	
5	Rated Drive Level	$P_o$	0.1		mW	
6	Frequency Adjustment Tolerance	$\frac{\Delta f}{f}$	-5.0	+5.0	$10^{-6}$	At $T_o$ °C
7	Resonance Resistance	$R_r$	-	40	$\Omega$	At $T_o$ °C
8	Frequency Variation with Temperature over $T_{op}$	$\frac{\Delta f}{f}$	-10	+10	$10^{-6}$	From frequency measured at $T_o$ °C
9	Resistance Variation with Temperature over $T_{op}$	$\frac{\Delta R}{R}$	-20	+20	%	From resistance measured at $T_o$ °C
10	Operating Temperature Range	$T_{op}$	-20	+70	°C	
11	Frequency variation with Drive Level	$\frac{\Delta f}{f}$	Not applicable		$10^{-6}$	
12	Resistance variation with Drive Level	$\frac{\Delta R}{R}$	Not applicable		%	
13	Motional Inductance	$L_1$	Not applicable		mH	
14	Motional Capacitance	$C_1$	Not applicable		fF	
15	Static Capacitance	$C_o$	-	7.0	pF	
16	Q Factor	Q	Not applicable		-	
17	Ratio of Unwanted: Response Resistance to Resonance Resistance or Response Impedance to Resonance Resistance	$R_p/R$ $ Z_p /R$	2:1	-		In the frequency range: $f_r - 70\text{kHz}$ to $f_r + 70\text{kHz}$
18	Ageing	$\frac{\Delta f}{f}$	-3.0	+3.0	$10^{-6}$	After burn-in, and per year
19	Terminal Length	L	Figure 2		mm	



**TABLE 1(a) - TYPE VARIANT DETAILED INFORMATION**

**TYPE VARIANT NO. 53**

No.	Characteristics	Symbol	Limits		Unit	Remarks
			Min.	Max.		
1	Resonance Frequency	$f_r$	83.07		MHz	$f_s = 83.0692\text{MHz}$
2	Reference Temperature	$T_o$	+23	+27	°C	
3	Overtone Order	-	3			
4	Load Capacitance	$C_L$	$\infty$		pF	
5	Rated Drive Level	$P_o$	0.1		mW	
6	Frequency Adjustment Tolerance	$\frac{\Delta f}{f}$	-5.0	+5.0	$10^{-6}$	At $T_o$ °C
7	Resonance Resistance	$R_r$	-	40	$\Omega$	At $T_o$ °C
8	Frequency Variation with Temperature over $T_{op}$	$\frac{\Delta f}{f}$	-10	+10	$10^{-6}$	From frequency measured at $T_o$ °C
9	Resistance Variation with Temperature over $T_{op}$	$\frac{\Delta R}{R}$	-20	+20	%	From resistance measured at $T_o$ °C
10	Operating Temperature Range	$T_{op}$	-20	+70	°C	
11	Frequency variation with Drive Level	$\frac{\Delta f}{f}$	Not applicable		$10^{-6}$	
12	Resistance variation with Drive Level	$\frac{\Delta R}{R}$	Not applicable		%	
13	Motional Inductance	$L_1$	Not applicable		mH	
14	Motional Capacitance	$C_1$	Not applicable		fF	
15	Static Capacitance	$C_o$	-	7.0	pF	
16	Q Factor	Q	Not applicable		-	
17	Ratio of Unwanted: Response Resistance to Resonance Resistance or Response Impedance to Resonance Resistance	$R_p/R$ or $ Z_p /R$	2:1	-		In the frequency range: $f_r - 70\text{kHz}$ to $f_r + 70\text{kHz}$
18	Ageing	$\frac{\Delta f}{f}$	-3.0	+3.0	$10^{-6}$	After burn-in, and per year
19	Terminal Length	L	Figure 2		mm	



**TABLE 1(a) - TYPE VARIANT DETAILED INFORMATION**

TYPE VARIANT NO. 54

No.	Characteristics	Symbol	Limits		Unit	Remarks
			Min.	Max.		
1	Resonance Frequency	$f_r$	37.063617		MHz	Swept
2	Reference Temperature	$T_o$	+23	+27	°C	
3	Overtone Order	-	3			
4	Load Capacitance	$C_L$	$\infty$		pF	
5	Rated Drive Level	$P_o$	0.1		mW	
6	Frequency Adjustment Tolerance	$\frac{\Delta f}{f}$	-10	+10	$10^{-6}$	At $T_o$ °C
7	Resonance Resistance	$R_r$	-	40	$\Omega$	At $T_o$ °C
8	Frequency Variation with Temperature over $T_{op}$	$\frac{\Delta f}{f}$	-9.0	+9.0	$10^{-6}$	From frequency measured at $T_o$ °C
9	Resistance Variation with Temperature over $T_{op}$	$\frac{\Delta R}{R}$	-10	+10	%	From resistance measured at $T_o$ °C
10	Operating Temperature Range	$T_{op}$	-20	+70	°C	
11	Frequency variation with Drive Level	$\frac{\Delta f}{f}$	Not applicable		$10^{-6}$	
12	Resistance variation with Drive Level	$\frac{\Delta R}{R}$	Not applicable		%	
13	Motional Inductance	$L_1$	17.3	21.3	mH	
14	Motional Capacitance	$C_1$	Not applicable		fF	
15	Static Capacitance	$C_o$	-	7.0	pF	
16	Q Factor	Q	19 000		-	
17	Ratio of Unwanted: Response Resistance to Resonance Resistance or Response Impedance to Resonance Resistance	$R_p/R$ $ Z_{pl}/R$	2:1	-		In the frequency range: $f_r - 50\text{kHz}$ to $f_r + 50\text{kHz}$
18	Ageing	$\frac{\Delta f}{f}$	-3.0	+3.0	$10^{-6}$	After burn-in, and per year
19	Terminal Length	L	Figure 2		mm	



**TABLE 1(a) - TYPE VARIANT DETAILED INFORMATION**

TYPE VARIANT NO. 55

No.	Characteristics	Symbol	Limits		Unit	Remarks
			Min.	Max.		
1	Resonance Frequency	$f_r$	37.083333		MHz	
2	Reference Temperature	$T_o$	+23	+27	°C	
3	Overtone Order	-	3			
4	Load Capacitance	$C_L$	$\infty$		pF	
5	Rated Drive Level	$P_o$	0.1		mW	
6	Frequency Adjustment Tolerance	$\frac{\Delta f}{f}$	-10	+10	$10^{-6}$	At $T_o$ °C
7	Resonance Resistance	$R_r$	-	40	$\Omega$	At $T_o$ °C
8	Frequency Variation with Temperature over $T_{op}$	$\frac{\Delta f}{f}$	-9.0	+9.0	$10^{-6}$	From frequency measured at $T_o$ °C
9	Resistance Variation with Temperature over $T_{op}$	$\frac{\Delta R}{R}$	-10	+10	%	From resistance measured at $T_o$ °C
10	Operating Temperature Range	$T_{op}$	-20	+70	°C	
11	Frequency variation with Drive Level	$\frac{\Delta f}{f}$	Not applicable		$10^{-6}$	
12	Resistance variation with Drive Level	$\frac{\Delta R}{R}$	Not applicable		%	
13	Motional Inductance	$L_1$	17.3	21.3	mH	
14	Motional Capacitance	$C_1$	Not applicable		fF	
15	Static Capacitance	$C_o$	-	7.0	pF	
16	Q Factor	Q	19 000		-	
17	Ratio of Unwanted: Response Resistance to Resonance Resistance or Response Impedance to Resonance Resistance	$R_p/R$ $ Z_{pl}/R$	2:1	-		In the frequency range: $f_r - 50\text{kHz}$ to $f_r + 50\text{kHz}$
18	Ageing	$\frac{\Delta f}{f}$	-3.0	+3.0	$10^{-6}$	After burn-in, and per year
19	Terminal Length	L	Figure 2		mm	



**TABLE 1(a) - TYPE VARIANT DETAILED INFORMATION**

**TYPE VARIANT NO. 56**

No.	Characteristics	Symbol	Limits		Unit	Remarks
			Min.	Max.		
1	Resonance Frequency	$f_r$	61.1875		MHz	
2	Reference Temperature	$T_o$			°C	
3	Overtone Order	-				
4	Load Capacitance	$C_L$			pF	
5	Rated Drive Level	$P_o$			mW	
6	Frequency Adjustment Tolerance	$\frac{\Delta f}{f}$			10 <sup>-6</sup>	At $T_o$ °C
7	Resonance Resistance	$R_r$			Ω	At $T_o$ °C
8	Frequency Variation with Temperature over $T_{op}$	$\frac{\Delta f}{f}$			10 <sup>-6</sup>	From frequency measured at $T_o$ °C
9	Resistance Variation with Temperature over $T_{op}$	$\frac{\Delta R}{R}$			%	From resistance measured at $T_o$ °C
10	Operating Temperature Range	$T_{op}$			°C	
11	Frequency variation with Drive Level	$\frac{\Delta f}{f}$			10 <sup>-6</sup>	From $P_{S1} = \text{mW}$ to $P_{S2} = \text{mW}$
12	Resistance variation with Drive Level	$\frac{\Delta R}{R}$			%	From $P_{S1} = \text{mW}$ to $P_{S2} = \text{mW}$
13	Motional Inductance	$L_1$			mH	
14	Motional Capacitance	$C_1$			fF	
15	Static Capacitance	$C_o$	-		pF	
16	Q Factor	Q		-	-	
17	Ratio of Unwanted: Response Resistance to Resonance Resistance or Response Impedance to Resonance Resistance	$R_p/R$ or $ Z_p /R$		-		In the frequency range: $f_r - \text{kHz}$ to $f_r + \text{kHz}$
18	Ageing	$\frac{\Delta f}{f}$			10 <sup>-6</sup>	
19	Terminal Length	L			mm	



**TABLE 1(a) - TYPE VARIANT DETAILED INFORMATION**

TYPE VARIANT NO. 57

No.	Characteristics	Symbol	Limits		Unit	Remarks
			Min.	Max.		
1	Resonance Frequency	$f_r$	65.00311		MHz	Swept
2	Reference Temperature	$T_o$	+23	+27	°C	
3	Overtone Order	-	3			
4	Load Capacitance	$C_L$	$\infty$		pF	
5	Rated Drive Level	$P_o$	0.1		mW	
6	Frequency Adjustment Tolerance	$\frac{\Delta f}{f}$	-10	+10	$10^{-6}$	At $T_o$ °C
7	Resonance Resistance	$R_r$	-	40	$\Omega$	At $T_o$ °C
8	Frequency Variation with Temperature over $T_{op}$	$\frac{\Delta f}{f}$	-10	+10	$10^{-6}$	From frequency measured at $T_o$ °C
9	Resistance Variation with Temperature over $T_{op}$	$\frac{\Delta R}{R}$	-10	+10	%	From resistance measured at $T_o$ °C
10	Operating Temperature Range	$T_{op}$	-20	+70	°C	
11	Frequency variation with Drive Level	$\frac{\Delta f}{f}$	Not applicable		$10^{-6}$	
12	Resistance variation with Drive Level	$\frac{\Delta R}{R}$	Not applicable		%	
13	Motional Inductance	$L_1$	3.2	4.8	mH	
14	Motional Capacitance	$C_1$	Not applicable		fF	
15	Static Capacitance	$C_o$	-	7.0	pF	
16	Q Factor	Q	70 000	-	-	
17	Ratio of Unwanted: Response Resistance to Resonance Resistance or Response Impedance to Resonance Resistance	$R_p/R$ or $ Z_p /R$	2:1	-		In the frequency range: $f_r - 50\text{kHz}$ to $f_r + 50\text{kHz}$
18	Ageing	$\frac{\Delta f}{f}$	-3.0	+3.0	$10^{-6}$	After burn-in, and per year
19	Terminal Length	L	Figure 2		mm	



**TABLE 1(a) - TYPE VARIANT DETAILED INFORMATION**

**TYPE VARIANT NO. 58**

No.	Characteristics	Symbol	Limits		Unit	Remarks
			Min.	Max.		
1	Resonance Frequency	$f_r$	85.48		MHz	Swept
2	Reference Temperature	$T_o$	+23	+27	°C	
3	Overtone Order	-	5			
4	Load Capacitance	$C_L$	$\infty$		pF	
5	Rated Drive Level	$P_o$	0.1		mW	
6	Frequency Adjustment Tolerance	$\frac{\Delta f}{f}$	-5.0	+5.0	$10^{-6}$	At $T_o$ °C
7	Resonance Resistance	$R_r$	-	60	$\Omega$	At $T_o$ °C
8	Frequency Variation with Temperature over $T_{op}$	$\frac{\Delta f}{f}$	-7.5	+7.5	$10^{-6}$	From frequency measured at $T_o$ °C
9	Resistance Variation with Temperature over $T_{op}$	$\frac{\Delta R}{R}$	-10	+10	%	From resistance measured at $T_o$ °C
10	Operating Temperature Range	$T_{op}$	-20	+70	°C	
11	Frequency variation with Drive Level	$\frac{\Delta f}{f}$	Not applicable		$10^{-6}$	
12	Resistance variation with Drive Level	$\frac{\Delta R}{R}$	Not applicable		%	
13	Motional Inductance	$L_1$	12	-	mH	
14	Motional Capacitance	$C_1$	Not applicable		fF	
15	Static Capacitance	$C_o$	-	7.0	pF	
16	Q Factor	Q	Not applicable		-	
17	Ratio of Unwanted: Response Resistance to Resonance Resistance or Response Impedance to Resonance Resistance	$R_p/R$ or $ Z_p /R$	2:1	-		In the frequency range: $f_r - 50\text{kHz}$ to $f_r + 50\text{kHz}$
18	Ageing	$\frac{\Delta f}{f}$	-2.0	+2.0	$10^{-6}$	After burn-in, and per year
19	Terminal Length	L	Figure 2		mm	





**TABLE 1(a) - TYPE VARIANT DETAILED INFORMATION**

**TYPE VARIANT NO. 59**

No.	Characteristics	Symbol	Limits		Unit	Remarks
			Min.	Max.		
1	Resonance Frequency	$f_L$	46.08005		MHz	Swept
2	Reference Temperature	$T_o$	+23	+27	°C	
3	Overtone Order	-	3			
4	Load Capacitance	$C_L$	12		pF	
5	Rated Drive Level	$P_o$	0.1		mW	
6	Frequency Adjustment Tolerance	$\frac{\Delta f}{f}$	-5.0	+5.0	10 <sup>-6</sup>	At $T_o$ °C
7	Resonance Resistance	$R_L$	-	40	Ω	At $T_o$ °C
8	Frequency Variation with Temperature over $T_{op}$	$\frac{\Delta f}{f}$	-10	+10	10 <sup>-6</sup>	From frequency measured at $T_o$ °C
9	Resistance Variation with Temperature over $T_{op}$	$\frac{\Delta R}{R}$	-10	+10	%	From resistance measured at $T_o$ °C
10	Operating Temperature Range	$T_{op}$	-20	+70	°C	
11	Frequency variation with Drive Level	$\frac{\Delta f}{f}$	Not applicable		10 <sup>-6</sup>	
12	Resistance variation with Drive Level	$\frac{\Delta R}{R}$	Not applicable		%	
13	Motional Inductance	$L_1$	17.42	23.57	mH	
14	Motional Capacitance	$C_1$	Not applicable		fF	
15	Static Capacitance	$C_o$	-	7.0	pF	
16	Q Factor	Q	50 000		-	
17	Ratio of Unwanted: Response Resistance to Resonance Resistance or Response Impedance to Resonance Resistance	$R_p/R$ or $ Z_{pl}/R$	2:1	-		In the frequency range: $f_L$ -50kHz to $f_L$ +50kHz
18	Ageing	$\frac{\Delta f}{f}$	-3.0	+3.0	10 <sup>-6</sup>	After burn-in, and per year
19	Terminal Length	L	Figure 2		mm	



**TABLE 1(a) - TYPE VARIANT DETAILED INFORMATION**

TYPE VARIANT NO. 60

No.	Characteristics	Symbol	Limits		Unit	Remarks
			Min.	Max.		
1	Resonance Frequency	$f_L$	16.0		MHz	
2	Reference Temperature	$T_o$	+ 60		°C	
3	Overtone Order	-	Fundamental			
4	Load Capacitance	$C_L$	22		pF	
5	Rated Drive Level	$P_o$	0.1		mW	
6	Frequency Adjustment Tolerance	$\frac{\Delta f}{f}$	-10	+ 10	$10^{-6}$	At $T_o$ °C
7	Resonance Resistance	$R_L$	-	13	$\Omega$	Over $T_{op}$ °C
8	Frequency Variation with Temperature over $T_{op}$	$\frac{\Delta f}{f}$	-15	+ 15	$10^{-6}$	From frequency measured at $T_o$ °C
9	Resistance Variation with Temperature over $T_{op}$	$\frac{\Delta R}{R}$	Not applicable		%	
10	Operating Temperature Range	$T_{op}$	-20	+ 70	°C	
11	Frequency variation with Drive Level	$\frac{\Delta f}{f}$	Not applicable		$10^{-6}$	
12	Resistance variation with Drive Level	$\frac{\Delta R}{R}$	Not applicable		%	
13	Motional Inductance	$L_1$	Not applicable		mH	
14	Motional Capacitance	$C_1$	Not applicable		fF	
15	Static Capacitance	$C_o$	-	5.0	pF	
16	Q Factor	Q	50 000		-	
17	Ratio of Unwanted: Response Resistance to Resonance Resistance or Response Impedance to Resonance Resistance	$R_p/R$ or $ Z_p /R$	3:1	-		In the frequency range: $f_L - 200\text{kHz}$ to $f_L + 200\text{kHz}$
18	Ageing	$\frac{\Delta f}{f}$	-3.0	+ 3.0	$10^{-6}$	After burn-in, and per year
19	Terminal Length	L	Figure 2		mm	



**TABLE 1(a) - TYPE VARIANT DETAILED INFORMATION**

TYPE VARIANT NO. 61

No.	Characteristics	Symbol	Limits		Unit	Remarks
			Min.	Max.		
1	Resonance Frequency	$f_r$	38.3117284		MHz	
2	Reference Temperature	$T_o$	+ 25		°C	
3	Overtone Order	-	3			
4	Load Capacitance	$C_L$	$\infty$		pF	
5	Rated Drive Level	$P_o$	0.1		mW	
6	Frequency Adjustment Tolerance	$\frac{\Delta f}{f}$	-5.0	+ 5.0	$10^{-6}$	At $T_o$ °C
7	Resonance Resistance	$R_r$	-	40	$\Omega$	At $T_o$ °C
8	Frequency Variation with Temperature over $T_{op}$	$\frac{\Delta f}{f}$	+ 7.0	-7.0	$10^{-6}$	From frequency measured at $T_o$ °C
9	Resistance Variation with Temperature over $T_{op}$	$\frac{\Delta R}{R}$	-20	+ 20	%	From resistance measured at $T_o$ °C
10	Operating Temperature Range	$T_{op}$	-20	+ 60	°C	
11	Frequency variation with Drive Level	$\frac{\Delta f}{f}$	Not applicable		$10^{-6}$	
12	Resistance variation with Drive Level	$\frac{\Delta R}{R}$	Not applicable		%	
13	Motional Inductance	$L_1$	Not applicable		mH	
14	Motional Capacitance	$C_1$	Not applicable		fF	
15	Static Capacitance	$C_o$	-	5.0	pF	
16	Q Factor	Q	Not applicable		-	
17	Ratio of Unwanted: Response Resistance to Resonance Resistance or Response Impedance to Resonance Resistance	$R_p/R$ $ Z_p /R$	3:1	-		In the frequency range: $f_r - 60\text{kHz}$ to $f_r + 60\text{kHz}$
18	Ageing	$\frac{\Delta f}{f}$	-3.0	+ 3.0	$10^{-6}$	After burn-in, and per year
19	Terminal Length	L	Figure 2		mm	



**TABLE 1(a) - TYPE VARIANT DETAILED INFORMATION**

TYPE VARIANT NO. 62

No.	Characteristics	Symbol	Limits		Unit	Remarks
			Min.	Max.		
1	Resonance Frequency	$f_L$	15.0		MHz	
2	Reference Temperature	$T_0$	+ 60		°C	
3	Overtone Order	-	Fundamental			
4	Load Capacitance	$C_L$	20	50	pF	
5	Rated Drive Level	$P_0$	0.1		mW	
6	Frequency Adjustment Tolerance	$\frac{\Delta f}{f}$	-10	+ 10	$10^{-6}$	At $T_0$ °C
7	Resonance Resistance	$R_L$	-	20	$\Omega$	At $T_0$ °C
8	Frequency Variation with Temperature over $T_{op}$	$\frac{\Delta f}{f}$	-10	+ 10	$10^{-6}$	From frequency measured at $T_0$ °C
9	Resistance Variation with Temperature over $T_{op}$	$\frac{\Delta R}{R}$	-10	+ 10 or -1.5 + 1.5	% $\Omega$	From resistance measured at $T_0$ °C If $R < 10\Omega$
10	Operating Temperature Range	$T_{op}$	-30	+ 70	°C	
11	Frequency variation with Drive Level	$\frac{\Delta f}{f}$	Not applicable		$10^{-6}$	
12	Resistance variation with Drive Level	$\frac{\Delta R}{R}$	Not applicable		%	
13	Motional Inductance	$L_1$	10.2	13.8	mH	
14	Motional Capacitance	$C_1$	Not applicable		fF	
15	Static Capacitance	$C_0$	-	7.0	pF	
16	Q Factor	Q	70 000	-	-	
17	Ratio of Unwanted: Response Resistance to Resonance Resistance or Response Impedance to Resonance Resistance	$R_p/R$   $Z_p$  /R	2:1	-		In the frequency range: $f_L - 200\text{kHz}$ to $f_L + 200\text{kHz}$
18	Ageing	$\frac{\Delta f}{f}$	-5.0	+ 5.0	$10^{-6}$	After burn-in, and per year
19	Terminal Length	L	Figure 2		mm	



**TABLE 1(a) - TYPE VARIANT DETAILED INFORMATION**

**TYPE VARIANT NO. 63**

No.	Characteristics	Symbol	Limits		Unit	Remarks
			Min.	Max.		
1	Resonance Frequency	$f_L$	16.0		MHz	
2	Reference Temperature	$T_o$	+59	+61	°C	
3	Overtone Order	-	Fundamental			
4	Load Capacitance	$C_L$	22		pF	
5	Rated Drive Level	$P_o$	0.1		mW	
6	Frequency Adjustment Tolerance	$\frac{\Delta f}{f}$	-10	+10	$10^{-6}$	At $T_o$ °C
7	Resonance Resistance	$R_L$	-	13	$\Omega$	At $T_o$ °C
8	Frequency Variation with Temperature over $T_{op}$	$\frac{\Delta f}{f}$	-15	+15	$10^{-6}$	From frequency measured at $T_o$ °C
9	Resistance Variation with Temperature over $T_{op}$	$\frac{\Delta R}{R}$	-10	+10	%	From resistance measured at $T_o$ °C If $R < 10\Omega$
			-1.5	+1.5	$\Omega$	
10	Operating Temperature Range	$T_{op}$	-20	+70	°C	
11	Frequency variation with Drive Level	$\frac{\Delta f}{f}$	Not applicable		$10^{-6}$	
12	Resistance variation with Drive Level	$\frac{\Delta R}{R}$	Not applicable		%	
13	Motional Inductance	$L_1$	Not applicable		mH	
14	Motional Capacitance	$C_1$	Not applicable		fF	
15	Static Capacitance	$C_o$	-	5.0	pF	
16	Q Factor	Q	50 000	-	-	
17	Ratio of Unwanted: Response Resistance to Resonance Resistance or Response Impedance to Resonance Resistance	$R_p/R$ or $ Z_p /R$	3:1	-		In the frequency range: $f_L - 200\text{kHz}$ to $f_L + 200\text{kHz}$
18	Ageing	$\frac{\Delta f}{f}$	-3.0	+3.0	$10^{-6}$	After burn-in and per year
19	Terminal Length	L	Figure 2		mm	



**TABLE 1(a) - TYPE VARIANT DETAILED INFORMATION**

**TYPE VARIANT NO. 64**

No.	Characteristics	Symbol	Limits		Unit	Remarks
			Min.	Max.		
1	Resonance Frequency	$f_L$	16.384		MHz	Swept
2	Reference Temperature	$T_0$	+59	+61	°C	
3	Overtone Order	-	Fundamental			
4	Load Capacitance	$C_L$	22		pF	
5	Rated Drive Level	$P_0$	0.1		mW	
6	Frequency Adjustment Tolerance	$\frac{\Delta f}{f}$	-10	+10	$10^{-6}$	At $T_0$ °C
7	Resonance Resistance	$R_L$	-	13	$\Omega$	At $T_0$ °C
8	Frequency Variation with Temperature over $T_{op}$	$\frac{\Delta f}{f}$	-15	+15	$10^{-6}$	From frequency measured at $T_0$ °C
9	Resistance Variation with Temperature over $T_{op}$	$\frac{\Delta R}{R}$	-10	+10	%	From resistance measured at $T_0$ °C If $R < 10\Omega$
			-1.5	+1.5	$\Omega$	
10	Operating Temperature Range	$T_{op}$	-20	+70	°C	
11	Frequency variation with Drive Level	$\frac{\Delta f}{f}$	Not applicable		$10^{-6}$	
12	Resistance variation with Drive Level	$\frac{\Delta R}{R}$	Not applicable		%	
13	Motional Inductance	$L_1$	Not applicable		mH	
14	Motional Capacitance	$C_1$	Not applicable		fF	
15	Static Capacitance	$C_0$	-	5.0	pF	
16	Q Factor	Q	50 000	-	-	
17	Ratio of Unwanted: Response Resistance to Resonance Resistance or Response Impedance to Resonance Resistance	$R_p/R$ or $ Z_p /R$	3:1	-		In the frequency range: $f_L - 200\text{kHz}$ to $f_L + 200\text{kHz}$
18	Ageing	$\frac{\Delta f}{f}$	-3.0	+3.0	$10^{-6}$	After burn-in and per year
19	Terminal Length	L	Figure 2		mm	



**TABLE 1(a) - TYPE VARIANT DETAILED INFORMATION**

**TYPE VARIANT NO. 65**

No.	Characteristics	Symbol	Limits		Unit	Remarks
			Min.	Max.		
1	Resonance Frequency	$f_r$	65.0047		MHz	Swept
2	Reference Temperature	$T_o$	+23	+27	°C	
3	Overtone Order	-	3			
4	Load Capacitance	$C_L$	$\infty$		pF	
5	Rated Drive Level	$P_o$	0.1		mW	
6	Frequency Adjustment Tolerance	$\frac{\Delta f}{f}$	-5.0	+5.0	$10^{-6}$	At $T_o$ °C
7	Resonance Resistance	$R_r$	-	40	$\Omega$	At $T_o$ °C
8	Frequency Variation with Temperature over $T_{op}$	$\frac{\Delta f}{f}$	-10	+10	$10^{-6}$	From frequency measured at $T_o$ °C
9	Resistance Variation with Temperature over $T_{op}$	$\frac{\Delta R}{R}$	-20	+20	%	From resistance measured at $T_o$ °C
10	Operating Temperature Range	$T_{op}$	-20	+70	°C	
11	Frequency variation with Drive Level	$\frac{\Delta f}{f}$	Not applicable		$10^{-6}$	
12	Resistance variation with Drive Level	$\frac{\Delta R}{R}$	Not applicable		%	
13	Motional Inductance	$L_1$	Not applicable		mH	
14	Motional Capacitance	$C_1$	Not applicable		fF	
15	Static Capacitance	$C_o$	-	7.0	pF	
16	Q Factor	Q	Not applicable		-	
17	Ratio of Unwanted: Response Resistance to Resonance Resistance or Response Impedance to Resonance Resistance	$R_p/R$ or $ Z_{p1}/R$	2:1	-		In the frequency range: $f_r - 60\text{kHz}$ to $f_r + 60\text{kHz}$
18	Ageing	$\frac{\Delta f}{f}$	-3.0	+3.0	$10^{-6}$	After burn-in, and per year
19	Terminal Length	L	Figure 2		mm	



**TABLE 1(a) - TYPE VARIANT DETAILED INFORMATION**

**TYPE VARIANT NO. 66**

No.	Characteristics	Symbol	Limits		Unit	Remarks
			Min.	Max.		
1	Resonance Frequency	$f_r$	65.0513		MHz	
2	Reference Temperature	$T_o$	+ 23	+ 27	°C	
3	Overtone Order	-	3			
4	Load Capacitance	$C_L$	$\infty$		pF	
5	Rated Drive Level	$P_o$	0.1		mW	
6	Frequency Adjustment Tolerance	$\frac{\Delta f}{f}$	-5.0	+ 5.0	$10^{-6}$	At $T_o$ °C
7	Resonance Resistance	$R_r$	-	40	$\Omega$	At $T_o$ °C
8	Frequency Variation with Temperature over $T_{op}$	$\frac{\Delta f}{f}$	-10	+ 10	$10^{-6}$	From frequency measured at $T_o$ °C
9	Resistance Variation with Temperature over $T_{op}$	$\frac{\Delta R}{R}$	-20	+ 20	%	From resistance measured at $T_o$ °C
10	Operating Temperature Range	$T_{op}$	-20	+ 70	°C	
11	Frequency variation with Drive Level	$\frac{\Delta f}{f}$	Not applicable		$10^{-6}$	
12	Resistance variation with Drive Level	$\frac{\Delta R}{R}$	Not applicable		%	
13	Motional Inductance	$L_1$	Not applicable		mH	
14	Motional Capacitance	$C_1$	Not applicable		fF	
15	Static Capacitance	$C_o$	-	7.0	pF	
16	Q Factor	Q	Not applicable		-	
17	Ratio of Unwanted: Response Resistance to Resonance Resistance or Response Impedance to Resonance Resistance	$R_p/R$ or $ Z_p /R$	2:1	-		In the frequency range: $f_r - 50\text{kHz}$ to $f_r + 50\text{kHz}$
18	Ageing	$\frac{\Delta f}{f}$	-3.0	+ 3.0	$10^{-6}$	After burn-in, and per year
19	Terminal Length	L	Figure 2		mm	





**TABLE 1(a) - TYPE VARIANT DETAILED INFORMATION**

**TYPE VARIANT NO. 67**

No.	Characteristics	Symbol	Limits		Unit	Remarks
			Min.	Max.		
1	Resonance Frequency	$f_r$	69.9992		MHz	
2	Reference Temperature	$T_o$	+23	+27	°C	
3	Overtone Order	-	3			
4	Load Capacitance	$C_L$	$\infty$		pF	
5	Rated Drive Level	$P_o$	0.1		mW	
6	Frequency Adjustment Tolerance	$\frac{\Delta f}{f}$	-5.0	+5.0	$10^{-6}$	At $T_o$ °C
7	Resonance Resistance	$R_r$	-	40	$\Omega$	At $T_o$ °C
8	Frequency Variation with Temperature over $T_{op}$	$\frac{\Delta f}{f}$	-10	+10	$10^{-6}$	From frequency measured at $T_o$ °C
9	Resistance Variation with Temperature over $T_{op}$	$\frac{\Delta R}{R}$	-20	+20	%	From resistance measured at $T_o$ °C
10	Operating Temperature Range	$T_{op}$	-20	+70	°C	
11	Frequency variation with Drive Level	$\frac{\Delta f}{f}$	Not applicable		$10^{-6}$	
12	Resistance variation with Drive Level	$\frac{\Delta R}{R}$	Not applicable		%	
13	Motional Inductance	$L_1$	Not applicable		mH	
14	Motional Capacitance	$C_1$	Not applicable		fF	
15	Static Capacitance	$C_o$	-	7.0	pF	
16	Q Factor	Q	Not applicable		-	
17	Ratio of Unwanted: Response Resistance to Resonance Resistance or Response Impedance to Resonance Resistance	$R_p/R$ or $ Z_p /R$	2:1	-		In the frequency range: $f_r - 60\text{kHz}$ to $f_r + 60\text{kHz}$
18	Ageing	$\frac{\Delta f}{f}$	-3.0	+3.0	$10^{-6}$	After burn-in, and per year
19	Terminal Length	L	Figure 2		mm	



**TABLE 1(a) - TYPE VARIANT DETAILED INFORMATION**

TYPE VARIANT NO. 68

No.	Characteristics	Symbol	Limits		Unit	Remarks
			Min.	Max.		
1	Resonance Frequency	$f_r$	85.4792		MHz	
2	Reference Temperature	$T_o$	+23	+27	°C	
3	Overtone Order	-	3			
4	Load Capacitance	$C_L$	$\infty$		pF	
5	Rated Drive Level	$P_o$	0.1		mW	
6	Frequency Adjustment Tolerance	$\frac{\Delta f}{f}$	-5.0	+5.0	$10^{-6}$	At $T_o$ °C
7	Resonance Resistance	$R_r$	-	40	$\Omega$	At $T_o$ °C
8	Frequency Variation with Temperature over $T_{op}$	$\frac{\Delta f}{f}$	+10	-10	$10^{-6}$	From frequency measured at $T_o$ °C
9	Resistance Variation with Temperature over $T_{op}$	$\frac{\Delta R}{R}$	-20	+20	%	From resistance measured at $T_o$ °C
10	Operating Temperature Range	$T_{op}$	-20	+70	°C	
11	Frequency variation with Drive Level	$\frac{\Delta f}{f}$	Not applicable		$10^{-6}$	
12	Resistance variation with Drive Level	$\frac{\Delta R}{R}$	Not applicable		%	
13	Motional Inductance	$L_1$	Not applicable		mH	
14	Motional Capacitance	$C_1$	Not applicable		fF	
15	Static Capacitance	$C_o$	-	7.0	pF	
16	Q Factor	Q	Not applicable		-	
17	Ratio of Unwanted: Response Resistance to Resonance Resistance or Response Impedance to Resonance Resistance	$R_p/R$ or $ Z_p /R$	2:1	-		In the frequency range: $f_r - 60\text{kHz}$ to $f_r + 60\text{kHz}$
18	Ageing	$\frac{\Delta f}{f}$	-3.0	+3.0	$10^{-6}$	After burn-in, and per year
19	Terminal Length	L	Figure 2		mm	



**TABLE 1(a) - TYPE VARIANT DETAILED INFORMATION**

TYPE VARIANT NO. 69

No.	Characteristics	Symbol	Limits		Unit	Remarks
			Min.	Max.		
1	Resonance Frequency	$f_L$	50.0		MHz	
2	Reference Temperature	$T_o$	+24.9	+25.1	°C	
3	Overtone Order	-	3			
4	Load Capacitance	$C_L$	30		pF	
5	Rated Drive Level	$P_o$	1.0		mW	
6	Frequency Adjustment Tolerance	$\frac{\Delta f}{f}$	-5.0	+5.0	10 <sup>-6</sup>	At $T_o$ °C
7	Resonance Resistance	$R_L$	-	50	Ω	Over $T_{op}$ °C
8	Frequency Variation with Temperature over $T_{op}$	$\frac{\Delta f}{f}$	-5.0	+5.0	10 <sup>-6</sup>	From frequency measured at $T_o$ °C
9	Resistance Variation with Temperature over $T_{op}$	$\frac{\Delta R}{R}$	Not applicable		%	
10	Operating Temperature Range	$T_{op}$	-5	+55	°C	
11	Frequency variation with Drive Level	$\frac{\Delta f}{f}$	Not applicable		10 <sup>-6</sup>	
12	Resistance variation with Drive Level	$\frac{\Delta R}{R}$	Not applicable		%	
13	Motional Inductance	$L_1$	Not applicable		mH	
14	Motional Capacitance	$C_1$	0.7	0.86	fF	
15	Static Capacitance	$C_o$	-	3.0	pF	
16	Q Factor	Q	100 000	-	-	
17	Ratio of Unwanted: Response Resistance to Resonance Resistance or Response Impedance to Resonance Resistance	Rp/R  Zp /R	8:1	-		In the frequency range: $f_L - 10\text{MHz}$ to $f_L + 10\text{MHz}$
18	Ageing	$\frac{\Delta f}{f}$	-10	+10	10 <sup>-6</sup>	After a run-in time of 680 hours, over 7 years
19	Terminal Length	L	Figure 2		mm	



**TABLE 1(a) - TYPE VARIANT DETAILED INFORMATION**

**TYPE VARIANT NO. 70**

No.	Characteristics	Symbol	Limits		Unit	Remarks
			Min.	Max.		
1	Resonance Frequency	$f_L$	20.0		MHz	
2	Reference Temperature	$T_o$	+ 59	+ 61	°C	
3	Overtone Order	-	Fundamental			
4	Load Capacitance	$C_L$	22		pF	
5	Rated Drive Level	$P_o$	0.1		mW	
6	Frequency Adjustment Tolerance	$\frac{\Delta f}{f}$	-10	+ 10	$10^{-6}$	At $T_o$ °C
7	Resonance Resistance	$R_L$	-	13	$\Omega$	At $T_o$ °C
8	Frequency Variation with Temperature over $T_{op}$	$\frac{\Delta f}{f}$	-15	+ 15	$10^{-6}$	From frequency measured at $T_o$ °C
9	Resistance Variation with Temperature over $T_{op}$	$\frac{\Delta R}{R}$	-10	+ 10 or -1.5 + 1.5	% $\Omega$	From resistance measured at $T_o$ °C If $R < 10\Omega$
10	Operating Temperature Range	$T_{op}$	- 20	+ 70	°C	
11	Frequency variation with Drive Level	$\frac{\Delta f}{f}$	Not applicable		$10^{-6}$	
12	Resistance variation with Drive Level	$\frac{\Delta R}{R}$	Not applicable		%	
13	Motional Inductance	$L_1$	Not applicable		mH	
14	Motional Capacitance	$C_1$	Not applicable		fF	
15	Static Capacitance	$C_o$	-	4.5	pF	
16	Q Factor	Q	50 000	-	-	
17	Ratio of Unwanted: Response Resistance to Resonance Resistance or Response Impedance to Resonance Resistance	$R_p/R$ or $ Z_p /R$	3:1	-		In the frequency range: $f_L - 200\text{kHz}$ to $f_L + 200\text{kHz}$
18	Ageing	$\frac{\Delta f}{f}$	-3.0	+ 3.0	$10^{-6}$	After burn-in and per year
19	Terminal Length	L	Figure 2		mm	



**TABLE 1(a) - TYPE VARIANT DETAILED INFORMATION**

**TYPE VARIANT NO. 71**

No.	Characteristics	Symbol	Limits		Unit	Remarks
			Min.	Max.		
1	Resonance Frequency	$f_L$	8.0		MHz	
2	Reference Temperature	$T_0$	+23	+27	°C	
3	Overtone Order	-	Fundamental			
4	Load Capacitance	$C_L$	29.7	30.3	pF	
5	Rated Drive Level	$P_0$	0.1		mW	
6	Frequency Adjustment Tolerance	$\frac{\Delta f}{f}$	-10	+10	$10^{-6}$	At $T_0$ °C
7	Resonance Resistance	$R_L$	-	30	$\Omega$	At $T_0$ °C
8	Frequency Variation with Temperature over $T_{op}$	$\frac{\Delta f}{f}$	-30	+30	$10^{-6}$	From frequency measured at $T_0$ °C
9	Resistance Variation with Temperature over $T_{op}$	$\frac{\Delta R}{R}$	-10	+10	%	From resistance measured at $T_0$ °C If $R < 10\Omega$
			-1.5	+1.5	$\Omega$	
10	Operating Temperature Range	$T_{op}$	-35	+105	°C	
11	Frequency variation with Drive Level	$\frac{\Delta f}{f}$	-2.0	+2.0	$10^{-6}$	From $P_{S1} = 20nW$ to $P_{S2} = 0.2mW$
12	Resistance variation with Drive Level	$\frac{\Delta R}{R}$	-25	+25	%	From $P_{S1} = 20nW$ to $P_{S2} = 0.2mW$
13	Motional Inductance	$L_1$	45	55	mH	
14	Motional Capacitance	$C_1$	7.2	8.8	fF	
15	Static Capacitance	$C_0$	2.75	3.75	pF	
16	Q Factor	Q	92 100	-	-	
17	Ratio of Unwanted: Response Resistance to Resonance Resistance or Response Impedance to Resonance Resistance	$R_p/R$ or $ Z_p /R$	2:1	-		In the frequency range: $f_L - 500kHz$ to $f_L + 500kHz$
18	Ageing	$\frac{\Delta f}{f}$	-5.0	+5.0	$10^{-6}$	After burn-in, over 10 years
19	Terminal Length	L	Figure 2		mm	



**TABLE 1(a) - TYPE VARIANT DETAILED INFORMATION**

TYPE VARIANT NO. 72

No.	Characteristics	Symbol	Limits		Unit	Remarks
			Min.	Max.		
1	Resonance Frequency	$f_r$	32.74375		MHz	
2	Reference Temperature	$T_o$	+24	+26	°C	
3	Overtone Order	-	3			
4	Load Capacitance	$C_L$	$\infty$		pF	
5	Rated Drive Level	$P_o$	0.1		mW	
6	Frequency Adjustment Tolerance	$\frac{\Delta f}{f}$	-5.0	+5.0	$10^{-6}$	At $T_o$ °C
7	Resonance Resistance	$R_r$	-	40	$\Omega$	At $T_o$ °C
8	Frequency Variation with Temperature over $T_{op}$	$\frac{\Delta f}{f}$	-9.0	+9.0	$10^{-6}$	From frequency measured at $T_o$ °C
9	Resistance Variation with Temperature over $T_{op}$	$\frac{\Delta R}{R}$	-10	+10	%	From resistance measured at $T_o$ °C
10	Operating Temperature Range	$T_{op}$	-20	+70	°C	
11	Frequency variation with Drive Level	$\frac{\Delta f}{f}$	Not applicable		$10^{-6}$	
12	Resistance variation with Drive Level	$\frac{\Delta R}{R}$	Not applicable		%	
13	Motional Inductance	$L_1$	15	22	mH	
14	Motional Capacitance	$C_1$	Not applicable		fF	
15	Static Capacitance	$C_o$	-	7.0	pF	
16	Q Factor	Q	90 000	-	-	
17	Ratio of Unwanted: Response Resistance to Resonance Resistance or Response Impedance to Resonance Resistance	$R_p/R$ or $ Z_p /R$	2:1	-		In the frequency range: $f_r - 50\text{kHz}$ to $f_r + 50\text{kHz}$
18	Ageing	$\frac{\Delta f}{f}$	-3.0	+3.0	$10^{-6}$	After burn-in, and per year
19	Terminal Length	L	Figure 2		mm	



**TABLE 1(a) - TYPE VARIANT DETAILED INFORMATION**

TYPE VARIANT NO. 73

No.	Characteristics	Symbol	Limits		Unit	Remarks
			Min.	Max.		
1	Resonance Frequency	$f_r$	37.827083		MHz	
2	Reference Temperature	$T_o$	+24	+26	°C	
3	Overtone Order	-	3			
4	Load Capacitance	$C_L$	$\infty$		pF	
5	Rated Drive Level	$P_o$	0.1		mW	
6	Frequency Adjustment Tolerance	$\frac{\Delta f}{f}$	-5.0	+5.0	$10^{-6}$	At $T_o$ °C
7	Resonance Resistance	$R_r$	-	40	$\Omega$	At $T_o$ °C
8	Frequency Variation with Temperature over $T_{op}$	$\frac{\Delta f}{f}$	-9.0	+9.0	$10^{-6}$	From frequency measured at $T_o$ °C
9	Resistance Variation with Temperature over $T_{op}$	$\frac{\Delta R}{R}$	-10	+10	%	From resistance measured at $T_o$ °C
10	Operating Temperature Range	$T_{op}$	-20	+70	°C	
11	Frequency variation with Drive Level	$\frac{\Delta f}{f}$	Not applicable		$10^{-6}$	
12	Resistance variation with Drive Level	$\frac{\Delta R}{R}$	Not applicable		%	
13	Motional Inductance	$L_1$	15	22	mH	
14	Motional Capacitance	$C_1$	Not applicable		fF	
15	Static Capacitance	$C_o$	-	7.0	pF	
16	Q Factor	Q	90 000	-	-	
17	Ratio of Unwanted: Response Resistance to Resonance Resistance or Response Impedance to Resonance Resistance	$R_p/R$ or $ Z_p /R$	2:1	-		In the frequency range: $f_r - 50\text{kHz}$ to $f_r + 50\text{kHz}$
18	Ageing	$\frac{\Delta f}{f}$	-3.0	+3.0	$10^{-6}$	After burn-in, and per year
19	Terminal Length	L	Figure 2		mm	



**TABLE 1(a) - TYPE VARIANT DETAILED INFORMATION**

TYPE VARIANT NO. 74

No.	Characteristics	Symbol	Limits		Unit	Remarks
			Min.	Max.		
1	Resonance Frequency	$f_L$	5.24288		MHz	
2	Reference Temperature	$T_o$	+23	+27	°C	
3	Overtone Order	-	Fundamental			
4	Load Capacitance	$C_L$	29.7	30.3	pF	
5	Rated Drive Level	$P_o$	0.1		mW	
6	Frequency Adjustment Tolerance	$\frac{\Delta f}{f}$	-10	+10	$10^{-6}$	At $T_o$ °C
7	Resonance Resistance	$R_L$	-	110	$\Omega$	At $T_o$ °C
8	Frequency Variation with Temperature over $T_{op}$	$\frac{\Delta f}{f}$	+30	-30	$10^{-6}$	From frequency measured at $T_o$ °C
9	Resistance Variation with Temperature over $T_{op}$	$\frac{\Delta R}{R}$	-25	+25	%	From resistance measured at $T_o$ °C
10	Operating Temperature Range	$T_{op}$	-25	+105	°C	
11	Frequency variation with Drive Level	$\frac{\Delta f}{f}$	-2.0	+2.0	$10^{-6}$	From $P_{S1} = 20nW$ to $P_{S2} = 0.2mW$
12	Resistance variation with Drive Level	$\frac{\Delta R}{R}$	-25	+25	%	From $P_{S1} = 20nW$ to $P_{S2} = 0.2mW$
13	Motional Inductance	$L_1$	138	168	mH	
14	Motional Capacitance	$C_1$	5.42	6.62	fF	
15	Static Capacitance	$C_o$	1.84	2.24	pF	
16	Q Factor	Q	41 300	-	-	
17	Ratio of Unwanted: Response Resistance to Resonance Resistance or Response Impedance to Resonance Resistance	$R_p/R$ or $ Z_p /R$	2:1	-		In the frequency range: $f_L - 500kHz$ to $f_L + 500kHz$
18	Ageing	$\frac{\Delta f}{f}$	-3.0	+3.0	$10^{-6}$	After burn-in, over 10 years
19	Terminal Length	L	Figure 2		mm	





**TABLE 1(a) - TYPE VARIANT DETAILED INFORMATION**

TYPE VARIANT NO. 75

No.	Characteristics	Symbol	Limits		Unit	Remarks
			Min.	Max.		
1	Resonance Frequency	$f_L$	4.096		MHz	
2	Reference Temperature	$T_o$	+23	+27	°C	
3	Overtone Order	-	Fundamental			
4	Load Capacitance	$C_L$	29.7	30.3	pF	
5	Rated Drive Level	$P_o$	0.1		mW	
6	Frequency Adjustment Tolerance	$\frac{\Delta f}{f}$	-10	+10	$10^{-6}$	At $T_o$ °C
7	Resonance Resistance	$R_L$	-	75	$\Omega$	At $T_o$ °C
8	Frequency Variation with Temperature over $T_{op}$	$\frac{\Delta f}{f}$	-25	+25	$10^{-6}$	From frequency measured at $T_o$ °C
9	Resistance Variation with Temperature over $T_{op}$	$\frac{\Delta R}{R}$	-25	+25	%	From resistance measured at $T_o$ °C
10	Operating Temperature Range	$T_{op}$	-25	+75	°C	
11	Frequency variation with Drive Level	$\frac{\Delta f}{f}$	-2.0	+2.0	$10^{-6}$	From $P_{S1} = 20nW$ to $P_{S2} = 0.2mW$
12	Resistance variation with Drive Level	$\frac{\Delta R}{R}$	-25	+25	%	From $P_{S1} = 20nW$ to $P_{S2} = 0.2mW$
13	Motional Inductance	$L_1$	313	348	mH	
14	Motional Capacitance	$C_1$	4.34	4.82	fF	
15	Static Capacitance	$C_o$	1.66	2.04	pF	
16	Q Factor	Q	107 000	-	-	
17	Ratio of Unwanted: Response Resistance to Resonance Resistance or Response Impedance to Resonance Resistance	$R_p/R$ or $ Z_p /R$	2:1	-		In the frequency range: $f_L -500kHz$ to $f_L +500kHz$
18	Ageing	$\frac{\Delta f}{f}$	-5.0	+5.0	$10^{-6}$	After burn-in, over 10 years
19	Terminal Length	L	Figure 2		mm	



**TABLE 1(a) - TYPE VARIANT DETAILED INFORMATION**

TYPE VARIANT NO. 76

No.	Characteristics	Symbol	Limits		Unit	Remarks
			Min.	Max.		
1	Resonance Frequency	$f_L$	5.12		MHz	
2	Reference Temperature	$T_o$	+23	+27	°C	
3	Overtone Order	-	Fundamental			
4	Load Capacitance	$C_L$	29.7	30.3	pF	
5	Rated Drive Level	$P_o$	0.1		mW	
6	Frequency Adjustment Tolerance	$\frac{\Delta f}{f}$	-10	+10	$10^{-6}$	At $T_o$ °C
7	Resonance Resistance	$R_L$	-	110	$\Omega$	At $T_o$ °C
8	Frequency Variation with Temperature over $T_{op}$	$\frac{\Delta f}{f}$	-30	+30	$10^{-6}$	From frequency measured at $T_o$ °C
9	Resistance Variation with Temperature over $T_{op}$	$\frac{\Delta R}{R}$	-25	+25	%	From resistance measured at $T_o$ °C
10	Operating Temperature Range	$T_{op}$	-35	+105	°C	
11	Frequency variation with Drive Level	$\frac{\Delta f}{f}$	-2.0	+2.0	$10^{-6}$	From $P_{S1} = 20nW$ to $P_{S2} = 0.2mW$
12	Resistance variation with Drive Level	$\frac{\Delta R}{R}$	-25	+25	%	From $P_{S1} = 20nW$ to $P_{S2} = 0.2mW$
13	Motional Inductance	$L_1$	146.7	179.3	mH	
14	Motional Capacitance	$C_1$	5.3	6.5	fF	
15	Static Capacitance	$C_o$	1.8	2.2	pF	
16	Q Factor	Q	47 896	-	-	
17	Ratio of Unwanted: Response Resistance to Resonance Resistance or Response Impedance to Resonance Resistance	$R_p/R$ or $ Z_p /R$	2:1	-		In the frequency range: $f_L -500kHz$ to $f_L +500kHz$
18	Ageing	$\frac{\Delta f}{f}$	-5.0	+5.0	$10^{-6}$	After burn-in, over 10 years
19	Terminal Length	L	Figure 2		mm	



**TABLE 1(a) - TYPE VARIANT DETAILED INFORMATION**

TYPE VARIANT NO. 77

No.	Characteristics	Symbol	Limits		Unit	Remarks
			Min.	Max.		
1	Resonance Frequency	$f_L$	6.5536		MHz	
2	Reference Temperature	$T_o$	+23	+27	°C	
3	Overtone Order	-	Fundamental			
4	Load Capacitance	$C_L$	29.7	30.3	pF	
5	Rated Drive Level	$P_o$	0.1		mW	
6	Frequency Adjustment Tolerance	$\frac{\Delta f}{f}$	-10	+10	$10^{-6}$	At $T_o$ °C
7	Resonance Resistance	$R_L$	-	70	$\Omega$	At $T_o$ °C
8	Frequency Variation with Temperature over $T_{op}$	$\frac{\Delta f}{f}$	-30	+30	$10^{-6}$	From frequency measured at $T_o$ °C
9	Resistance Variation with Temperature over $T_{op}$	$\frac{\Delta R}{R}$	-25	+25	%	From resistance measured at $T_o$ °C
10	Operating Temperature Range	$T_{op}$	-35	+105	°C	
11	Frequency variation with Drive Level	$\frac{\Delta f}{f}$	-2.0	+2.0	$10^{-6}$	From $P_{S1} = ?mW$ to $P_{S2} = ?mW$
12	Resistance variation with Drive Level	$\frac{\Delta R}{R}$	-25	+25	%	From $P_{S1} = ?mW$ to $P_{S2} = ?mW$
13	Motional Inductance	$L_1$	64.6	79.0	mH	
14	Motional Capacitance	$C_1$	7.47	9.13	fF	
15	Static Capacitance	$C_o$	2.28	2.78	pF	
16	Q Factor	Q	48 860	-	-	
17	Ratio of Unwanted: Response Resistance to Resonance Resistance or Response Impedance to Resonance Resistance	$R_p/R$ or $ Z_p /R$	2:1	-		In the frequency range: $f_L -500kHz$ to $f_L +500kHz$
18	Ageing	$\frac{\Delta f}{f}$	-5.0	+5.0	$10^{-6}$	After burn-in, over 10 years
19	Terminal Length	L	Figure 2		mm	



**TABLE 1(a) - TYPE VARIANT DETAILED INFORMATION**

TYPE VARIANT NO. 78

No.	Characteristics	Symbol	Limits		Unit	Remarks
			Min.	Max.		
1	Resonance Frequency	$f_r$	65.04974		MHz	Swept
2	Reference Temperature	$T_o$	+23	+27	°C	
3	Overtone Order	-	3			
4	Load Capacitance	$C_L$	$\infty$		pF	
5	Rated Drive Level	$P_o$	0.1		mW	
6	Frequency Adjustment Tolerance	$\frac{\Delta f}{f}$	-10	+10	$10^{-6}$	At $T_o$ °C
7	Resonance Resistance	$R_r$	-	40	$\Omega$	At $T_o$ °C
8	Frequency Variation with Temperature over $T_{op}$	$\frac{\Delta f}{f}$	-9.0	+9.0	$10^{-6}$	From frequency measured at $T_o$ °C
9	Resistance Variation with Temperature over $T_{op}$	$\frac{\Delta R}{R}$	-10	+10	%	From resistance measured at $T_o$ °C
10	Operating Temperature Range	$T_{op}$	-20	+70	°C	
11	Frequency variation with Drive Level	$\frac{\Delta f}{f}$	Not applicable		$10^{-6}$	
12	Resistance variation with Drive Level	$\frac{\Delta R}{R}$	Not applicable		%	
13	Motional Inductance	$L_1$	3.2	4.8	mH	
14	Motional Capacitance	$C_1$	Not applicable		fF	
15	Static Capacitance	$C_o$	-	7.0	pF	
16	Q Factor	Q	Not applicable		-	
17	Ratio of Unwanted: Response Resistance to Resonance Resistance or Response Impedance to Resonance Resistance	$R_p/R$   $Z_p$  /R	2:1	-		In the frequency range: $f_r - 50\text{kHz}$ to $f_r + 50\text{kHz}$
18	Ageing	$\frac{\Delta f}{f}$	-3.0	+3.0	$10^{-6}$	After burn-in, and per year
19	Terminal Length	L	Figure 2		mm	



**TABLE 1(a) - TYPE VARIANT DETAILED INFORMATION**

TYPE VARIANT NO. 79

No.	Characteristics	Symbol	Limits		Unit	Remarks
			Min.	Max.		
1	Resonance Frequency	$f_r$	65.005555		MHz	Swept
2	Reference Temperature	$T_o$	+23	+27	°C	
3	Overtone Order	-	3			
4	Load Capacitance	$C_L$	$\infty$		pF	
5	Rated Drive Level	$P_o$	0.1		mW	
6	Frequency Adjustment Tolerance	$\frac{\Delta f}{f}$	-10	+10	$10^{-6}$	At $T_o$ °C
7	Resonance Resistance	$R_r$	-	40	$\Omega$	At $T_o$ °C
8	Frequency Variation with Temperature over $T_{op}$	$\frac{\Delta f}{f}$	+9.0	-9.0	$10^{-6}$	From frequency measured at $T_o$ °C
9	Resistance Variation with Temperature over $T_{op}$	$\frac{\Delta R}{R}$	-10	+10	%	From resistance measured at $T_o$ °C
10	Operating Temperature Range	$T_{op}$	-20	+70	°C	
11	Frequency variation with Drive Level	$\frac{\Delta f}{f}$	Not applicable		$10^{-6}$	
12	Resistance variation with Drive Level	$\frac{\Delta R}{R}$	Not applicable		%	
13	Motional Inductance	$L_1$	3.2	4.8	mH	
14	Motional Capacitance	$C_1$	Not applicable		fF	
15	Static Capacitance	$C_o$	-	7.0	pF	
16	Q Factor	Q	Not applicable		-	
17	Ratio of Unwanted: Response Resistance to Resonance Resistance or Response Impedance to Resonance Resistance	$R_p/R$ or $ Z_p /R$	2:1	-		In the frequency range: $f_r - 50\text{kHz}$ to $f_r + 50\text{kHz}$
18	Ageing	$\frac{\Delta f}{f}$	-3.0	+3.0	$10^{-6}$	After burn-in, and per year
19	Terminal Length	L	Figure 2		mm	



**TABLE 1(a) - TYPE VARIANT DETAILED INFORMATION**

TYPE VARIANT NO. 80

No.	Characteristics	Symbol	Limits		Unit	Remarks
			Min.	Max.		
1	Resonance Frequency	$f_r$	62.5		MHz	Swept
2	Reference Temperature	$T_o$	+23	+27	°C	
3	Overtone Order	-	3			
4	Load Capacitance	$C_L$	$\infty$		pF	
5	Rated Drive Level	$P_o$	0.1		mW	
6	Frequency Adjustment Tolerance	$\frac{\Delta f}{f}$	-10	+10	$10^{-6}$	At $T_o$ °C
7	Resonance Resistance	$R_r$	-	40	$\Omega$	At $T_o$ °C
8	Frequency Variation with Temperature over $T_{op}$	$\frac{\Delta f}{f}$	-9.0	+9.0	$10^{-6}$	From frequency measured at $T_o$ °C
9	Resistance Variation with Temperature over $T_{op}$	$\frac{\Delta R}{R}$	-10	+10	%	From resistance measured at $T_o$ °C
10	Operating Temperature Range	$T_{op}$	-20	+70	°C	
11	Frequency variation with Drive Level	$\frac{\Delta f}{f}$	Not applicable		$10^{-6}$	
12	Resistance variation with Drive Level	$\frac{\Delta R}{R}$	Not applicable		%	
13	Motional Inductance	$L_1$	3.2	4.8	mH	
14	Motional Capacitance	$C_1$	1.5 Typical		fF	
15	Static Capacitance	$C_o$	-	7.0	pF	
16	Q Factor	Q	Not applicable		-	
17	Ratio of Unwanted: Response Resistance to Resonance Resistance or Response Impedance to Resonance Resistance	$R_p/R$ or $ Z_p /R$	2:1	-		In the frequency range: $f_r - 50\text{kHz}$ to $f_r + 50\text{kHz}$
18	Ageing	$\frac{\Delta f}{f}$	-3.0	+3.0	$10^{-6}$	After burn-in, and per year
19	Terminal Length	L	Figure 2		mm	



**TABLE 1(a) - TYPE VARIANT DETAILED INFORMATION**

TYPE VARIANT NO. 81

No.	Characteristics	Symbol	Limits		Unit	Remarks
			Min.	Max.		
1	Resonance Frequency	$f_r$	70.0		MHz	Swept
2	Reference Temperature	$T_o$	+23	+27	°C	
3	Overtone Order	-	3			
4	Load Capacitance	$C_L$	$\infty$		pF	
5	Rated Drive Level	$P_o$	0.1		mW	
6	Frequency Adjustment Tolerance	$\frac{\Delta f}{f}$	-10	+10	$10^{-6}$	At $T_o$ °C
7	Resonance Resistance	$R_r$	-	40	$\Omega$	At $T_o$ °C
8	Frequency Variation with Temperature over $T_{op}$	$\frac{\Delta f}{f}$	-9.0	+9.0	$10^{-6}$	From frequency measured at $T_o$ °C
9	Resistance Variation with Temperature over $T_{op}$	$\frac{\Delta R}{R}$	-10	+10	%	From resistance measured at $T_o$ °C
10	Operating Temperature Range	$T_{op}$	-20	+70	°C	
11	Frequency variation with Drive Level	$\frac{\Delta f}{f}$	Not applicable		$10^{-6}$	
12	Resistance variation with Drive Level	$\frac{\Delta R}{R}$	Not applicable		%	
13	Motional Inductance	$L_1$	3.2	4.8	mH	
14	Motional Capacitance	$C_1$	1.5 Typical		fF	
15	Static Capacitance	$C_o$	-	7.0	pF	
16	Q Factor	Q	Not applicable		-	
17	Ratio of Unwanted: Response Resistance to Resonance Resistance or Response Impedance to Resonance Resistance	$R_p/R$ or $ Z_p /R$	2:1	-		In the frequency range: $f_r - 50\text{kHz}$ to $f_r + 50\text{kHz}$
18	Ageing	$\frac{\Delta f}{f}$	-3.0	+3.0	$10^{-6}$	After burn-in, and per year
19	Terminal Length	L	Figure 2		mm	



**TABLE 1(a) - TYPE VARIANT DETAILED INFORMATION**

**TYPE VARIANT NO. 82**

No.	Characteristics	Symbol	Limits		Unit	Remarks
			Min.	Max.		
1	Resonance Frequency	$f_L$	4.1379		MHz	
2	Reference Temperature	$T_o$	+23	+27	°C	
3	Overtone Order	-	Fundamental			
4	Load Capacitance	$C_L$	29.7	30.3	pF	
5	Rated Drive Level	$P_o$	0.1		mW	
6	Frequency Adjustment Tolerance	$\frac{\Delta f}{f}$	-10	+10	$10^{-6}$	At $T_o$ °C
7	Resonance Resistance	$R_L$	-	75	$\Omega$	At $T_o$ °C
8	Frequency Variation with Temperature over $T_{op}$	$\frac{\Delta f}{f}$	-25	+25	$10^{-6}$	From frequency measured at $T_o$ °C
9	Resistance Variation with Temperature over $T_{op}$	$\frac{\Delta R}{R}$	-50	+50	%	From resistance measured at $T_o$ °C
10	Operating Temperature Range	$T_{op}$	-25	+75	°C	
11	Frequency variation with Drive Level	$\frac{\Delta f}{f}$	-2.0	+2.0	$10^{-6}$	From $P_{S1} = 20nW$ to $P_{S2} = 0.2mW$
12	Resistance variation with Drive Level	$\frac{\Delta R}{R}$	-40	+40	%	From $P_{S1} = 20nW$ to $P_{S2} = 0.2mW$
13	Motional Inductance	$L_1$	310	345	mH	
14	Motional Capacitance	$C_1$	4.39	4.87	fF	
15	Static Capacitance	$C_o$	1.67	2.06	pF	
16	Q Factor	Q	105 000	-	-	
17	Ratio of Unwanted: Response Resistance to Resonance Resistance or Response Impedance to Resonance Resistance	$R_p/R$ or $ Z_p /R$	2:1	-		In the frequency range: $f_L - 500kHz$ to $f_L + 500kHz$
18	Ageing	$\frac{\Delta f}{f}$	-5.0	+5.0	$10^{-6}$	After burn-in, over 10 years
19	Terminal Length	L	Figure 2		mm	





**TABLE 1(a) - TYPE VARIANT DETAILED INFORMATION**

**TYPE VARIANT NO. 83**

No.	Characteristics	Symbol	Limits		Unit	Remarks
			Min.	Max.		
1	Resonance Frequency	$f_r$	65.03639		MHz	Swept
2	Reference Temperature	$T_o$	+23	+27	°C	
3	Overtone Order	-	3			
4	Load Capacitance	$C_L$	$\infty$		pF	
5	Rated Drive Level	$P_o$	0.1		mW	
6	Frequency Adjustment Tolerance	$\frac{\Delta f}{f}$	-10	+10	$10^{-6}$	At $T_o$ °C
7	Resonance Resistance	$R_r$	-	40	$\Omega$	At $T_o$ °C
8	Frequency Variation with Temperature over $T_{op}$	$\frac{\Delta f}{f}$	-9.0	+9.0	$10^{-6}$	From frequency measured at $T_o$ °C
9	Resistance Variation with Temperature over $T_{op}$	$\frac{\Delta R}{R}$	-10	+10	%	From resistance measured at $T_o$ °C
10	Operating Temperature Range	$T_{op}$	-20	+70	°C	
11	Frequency variation with Drive Level	$\frac{\Delta f}{f}$	Not applicable		$10^{-6}$	
12	Resistance variation with Drive Level	$\frac{\Delta R}{R}$	Not applicable		%	
13	Motional Inductance	$L_1$	3.2	4.8	mH	
14	Motional Capacitance	$C_1$	1.5 Typical		fF	
15	Static Capacitance	$C_o$	-	7.0	pF	
16	Q Factor	Q	Not applicable		-	
17	Ratio of Unwanted: Response Resistance to Resonance Resistance or Response Impedance to Resonance Resistance	$R_p/R$ or $ Z_p /R$	2:1	-		In the frequency range: $f_r - 50\text{kHz}$ to $f_r + 50\text{kHz}$
18	Ageing	$\frac{\Delta f}{f}$	-3.0	+3.0	$10^{-6}$	After burn-in, and per year
19	Terminal Length	L	Figure 2		mm	



**TABLE 1(a) - TYPE VARIANT DETAILED INFORMATION**

TYPE VARIANT NO. 84

No.	Characteristics	Symbol	Limits		Unit	Remarks
			Min.	Max.		
1	Resonance Frequency	$f_r$	36.811767		MHz	
2	Reference Temperature	$T_o$	+25		°C	
3	Overtone Order	-	3			
4	Load Capacitance	$C_L$	$\infty$		pF	
5	Rated Drive Level	$P_o$	0.1		mW	
6	Frequency Adjustment Tolerance	$\frac{\Delta f}{f}$	-5.0	+5.0	$10^{-6}$	At $T_o$ °C
7	Resonance Resistance	$R_r$	-	40	$\Omega$	Over $T_{op}$ °C
8	Frequency Variation with Temperature over $T_{op}$	$\frac{\Delta f}{f}$	+7.0	-7.0	$10^{-6}$	From frequency measured at $T_o$ °C
9	Resistance Variation with Temperature over $T_{op}$	$\frac{\Delta R}{R}$	Not applicable		%	
10	Operating Temperature Range	$T_{op}$	-25	+70	°C	
11	Frequency variation with Drive Level	$\frac{\Delta f}{f}$	Not applicable		$10^{-6}$	
12	Resistance variation with Drive Level	$\frac{\Delta R}{R}$	Not applicable		%	
13	Motional Inductance	$L_1$	Not applicable		mH	
14	Motional Capacitance	$C_1$	Not applicable		fF	
15	Static Capacitance	$C_o$	-	5.0	pF	
16	Q Factor	Q	Not applicable		-	
17	Ratio of Unwanted: Response Resistance to Resonance Resistance or Response Impedance to Resonance Resistance	$R_p/R$ $ Z_p /R$	3:1	-		In the frequency range: $f_r - 60\text{kHz}$ to $f_r + 60\text{kHz}$
18	Ageing	$\frac{\Delta f}{f}$	-7.0	+7.0	$10^{-6}$	After burn-in, over 7 years
19	Terminal Length	L	Figure 2		mm	



**TABLE 1(a) - TYPE VARIANT DETAILED INFORMATION**

TYPE VARIANT NO. 85

No.	Characteristics	Symbol	Limits		Unit	Remarks
			Min.	Max.		
1	Resonance Frequency	$f_r$	20.0		MHz	
2	Reference Temperature	$T_o$	+23	+27	°C	
3	Overtone Order	-	Fundamental			
4	Load Capacitance	$C_L$	$\infty$		pF	
5	Rated Drive Level	$P_o$	0.1		mW	
6	Frequency Adjustment Tolerance	$\frac{\Delta f}{f}$	-10	+10	$10^{-6}$	At $T_o$ °C
7	Resonance Resistance	$R_r$	-	30	$\Omega$	Over $T_{op}$ °C
8	Frequency Variation with Temperature over $T_{op}$	$\frac{\Delta f}{f}$	-20	+20	$10^{-6}$	From frequency measured at $T_o$ °C
9	Resistance Variation with Temperature over $T_{op}$	$\frac{\Delta R}{R}$	-10 or -2	+10 or +2	%  $\Omega$	From resistance measured at $T_o$ °C
10	Operating Temperature Range	$T_{op}$	-30	+70	°C	
11	Frequency variation with Drive Level	$\frac{\Delta f}{f}$	Not applicable		$10^{-6}$	
12	Resistance variation with Drive Level	$\frac{\Delta R}{R}$	Not applicable		%	
13	Motional Inductance	$L_1$	Not applicable		mH	
14	Motional Capacitance	$C_1$	Not applicable		fF	
15	Static Capacitance	$C_o$	-	7.0	pF	
16	Q Factor	Q	100 000	-	-	
17	Ratio of Unwanted: Response Resistance to Resonance Resistance or Response Impedance to Resonance Resistance	$R_p/R$ or $ Z_p /R$	2:1	-		In the frequency range: $f_r - 200\text{kHz}$ to $f_r + 200\text{kHz}$
18	Ageing	$\frac{\Delta f}{f}$	-2	+2	$10^{-6}$	After burn-in per year
19	Terminal Length	L	Figure 2		mm	



**TABLE 1(a) - TYPE VARIANT DETAILED INFORMATION**

TYPE VARIANT NO. 86

No.	Characteristics	Symbol	Limits		Unit	Remarks
			Min.	Max.		
1	Resonance Frequency	$f_L$	20.0		MHz	
2	Reference Temperature	$T_o$	+23	+27	°C	
3	Overtone Order	-	Fundamental			
4	Load Capacitance	$C_L$	32		pF	
5	Rated Drive Level	$P_o$	0.1		mW	
6	Frequency Adjustment Tolerance	$\frac{\Delta f}{f}$	-10	+10	$10^{-6}$	At $T_o$ °C
7	Resonance Resistance	$R_r$	-	30	$\Omega$	At $T_o$ °C
8	Frequency Variation with Temperature over $T_{op}$	$\frac{\Delta f}{f}$	-20	+20	$10^{-6}$	From frequency measured at $T_o$ °C
9	Resistance Variation with Temperature over $T_{op}$	$\frac{\Delta R}{R}$	-10 or -2.0	+10 or +2.0	% $\Omega$	From resistance measured at $T_o$ °C
10	Operating Temperature Range	$T_{op}$	-30	+70	°C	
11	Frequency variation with Drive Level	$\frac{\Delta f}{f}$	Not applicable		$10^{-6}$	
12	Resistance variation with Drive Level	$\frac{\Delta R}{R}$	Not applicable		%	
13	Motional Inductance	$L_1$	Not applicable		mH	
14	Motional Capacitance	$C_1$	-	7.0	fF	
15	Static Capacitance	$C_o$	-	7.0	pF	
16	Q Factor	Q	80 000	-	-	
17	Ratio of Unwanted: Response Resistance to Resonance Resistance or Response Impedance to Resonance Resistance	$R_p/R$ $ Z_p /R$	2:1	-		In the frequency range: $f_L - 200kHz$ to $f_L + 200kHz$
18	Ageing	$\frac{\Delta f}{f}$	-2.0	+2.0	$10^{-6}$	After burn-in and per year
19	Terminal Length	L	Figure 2		mm	



**TABLE 1(a) - TYPE VARIANT DETAILED INFORMATION**

TYPE VARIANT NO. 87

No.	Characteristics	Symbol	Limits		Unit	Remarks
			Min.	Max.		
1	Resonance Frequency	$f_r$	81.506849		MHz	PQ. Swept
2	Reference Temperature	$T_o$	+65	+75	°C	Turn-on Point
3	Overtone Order	-	3			
4	Load Capacitance	$C_L$	$\infty$		pF	
5	Rated Drive Level	$P_o$	0.1		mW	
6	Frequency Adjustment Tolerance	$\frac{\Delta f}{f}$	-50	+50	$10^{-6}$	At $T_o$ °C
7	Resonance Resistance	$R_r$	-	40	$\Omega$	At $T_o$ °C
8	Frequency Variation with Temperature over $T_{op}$	$\frac{\Delta f}{f}$	Not applicable		$10^{-6}$	
9	Resistance Variation with Temperature over $T_{op}$	$\frac{\Delta R}{R}$	-20	+20	%	From resistance measured at $T_o$ °C
10	Operating Temperature Range	$T_{op}$	-20	+80	°C	
11	Frequency variation with Drive Level	$\frac{\Delta f}{f}$	Not applicable		$10^{-6}$	
12	Resistance variation with Drive Level	$\frac{\Delta R}{R}$	Not applicable		%	
13	Motional Inductance	$L_1$	2.0	-	mH	
14	Motional Capacitance	$C_1$	Not applicable		fF	
15	Static Capacitance	$C_o$	-	5.0	pF	
16	Q Factor	Q	70 000		-	
17	Ratio of Unwanted: Response Resistance to Resonance Resistance or Response Impedance to Resonance Resistance	$R_p/R$ or $ Z_p /R$	2:1	-		In the frequency range: $f_r - 8100\text{kHz}$ to $f_r + 8100\text{kHz}$
18	Ageing	$\frac{\Delta f}{f}$	-5.0	+5.0	$10^{-6}$	After burn-in and over 10 years
19	Terminal Length	L	Figure 2		mm	



**TABLE 1(a) - TYPE VARIANT DETAILED INFORMATION**

TYPE VARIANT NO. 88

No.	Characteristics	Symbol	Limits		Unit	Remarks
			Min.	Max.		
1	Resonance Frequency	$f_r$	121.5		MHz	
2	Reference Temperature	$T_o$	+23	+27	°C	
3	Overtone Order	-	5			
4	Load Capacitance	$C_L$	$\infty$		pF	
5	Rated Drive Level	$P_o$	0.1		mW	
6	Frequency Adjustment Tolerance	$\frac{\Delta f}{f}$	-10	+10	$10^{-6}$	At $T_o$ °C
7	Resonance Resistance	$R_r$	-	60	$\Omega$	At $T_o$ °C
8	Frequency Variation with Temperature over $T_{op}$	$\frac{\Delta f}{f}$	-20	+20	$10^{-6}$	From frequency measured at $T_o$ °C
9	Resistance Variation with Temperature over $T_{op}$	$\frac{\Delta R}{R}$	-25	+25	%	From resistance measured at $T_o$ °C
10	Operating Temperature Range	$T_{op}$	-30	+80	°C	
11	Frequency variation with Drive Level	$\frac{\Delta f}{f}$	Not applicable		$10^{-6}$	
12	Resistance variation with Drive Level	$\frac{\Delta R}{R}$	Not applicable		%	
13	Motional Inductance	$L_1$	1.44	2.16	mH	
14	Motional Capacitance	$C_1$	Not applicable		fF	
15	Static Capacitance	$C_o$	-	6.0	pF	
16	Q Factor	Q	Not applicable		-	
17	Ratio of Unwanted: Response Resistance to Resonance Resistance or Response Impedance to Resonance Resistance	$R_p/R$ or $ Z_{pl}/R$	2:1	-		In the frequency range: $f_r - 500\text{kHz}$ to $f_r + 500\text{kHz}$
18	Ageing	$\frac{\Delta f}{f}$	-5.0	+5.0	$10^{-6}$	After burn-in, over 10 years
19	Terminal Length	L	Figure 2		mm	



**TABLE 1(a) - TYPE VARIANT DETAILED INFORMATION**

**TYPE VARIANT NO. 89**

No.	Characteristics	Symbol	Limits		Unit	Remarks
			Min.	Max.		
1	Resonance Frequency	$f_r$	50.0		MHz	
2	Reference Temperature	$T_o$	+23	+27	°C	
3	Overtone Order	-	3			
4	Load Capacitance	$C_L$	$\infty$		pF	
5	Rated Drive Level	$P_o$	0.1		mW	
6	Frequency Adjustment Tolerance	$\frac{\Delta f}{f}$	-10	+10	$10^{-6}$	At $T_o$ °C
7	Resonance Resistance	$R_r$	-	40	$\Omega$	At $T_o$ °C
8	Frequency Variation with Temperature over $T_{op}$	$\frac{\Delta f}{f}$	-20	+20	$10^{-6}$	From frequency measured at $T_o$ °C
9	Resistance Variation with Temperature over $T_{op}$	$\frac{\Delta R}{R}$	-20	+20	%	From resistance measured at $T_o$ °C
10	Operating Temperature Range	$T_{op}$	-30	+80	°C	
11	Frequency variation with Drive Level	$\frac{\Delta f}{f}$	Not applicable		$10^{-6}$	
12	Resistance variation with Drive Level	$\frac{\Delta R}{R}$	Not applicable		%	
13	Motional Inductance	$L_1$	2.97	4.45	mH	
14	Motional Capacitance	$C_1$	Not applicable		fF	
15	Static Capacitance	$C_o$	-	6.0	pF	
16	Q Factor	Q	Not applicable		-	
17	Ratio of Unwanted: Response Resistance to Resonance Resistance or Response Impedance to Resonance Resistance	$R_p/R$ $ Z_p /R$	2:1	-		In the frequency range: $f_r - 500\text{kHz}$ to $f_r + 500\text{kHz}$
18	Ageing	$\frac{\Delta f}{f}$	-10	+10	$10^{-6}$	After burn-in, over 10 years
19	Terminal Length	L	Figure 2		mm	



**TABLE 1(a) - TYPE VARIANT DETAILED INFORMATION**

TYPE VARIANT NO. 90

No.	Characteristics	Symbol	Limits		Unit	Remarks
			Min.	Max.		
1	Resonance Frequency	$f_r$	37.75625		MHz	Swept
2	Reference Temperature	$T_o$	+ 24	+ 26	°C	
3	Overtone Order	-	3			
4	Load Capacitance	$C_L$	$\infty$		pF	
5	Rated Drive Level	$P_o$	0.1		mW	
6	Frequency Adjustment Tolerance	$\frac{\Delta f}{f}$	-5.0	+ 5.0	$10^{-6}$	At $T_o$ °C
7	Resonance Resistance	$R_r$	-	40	$\Omega$	At $T_o$ °C
8	Frequency Variation with Temperature over $T_{op}$	$\frac{\Delta f}{f}$	-9.0	+ 9.0	$10^{-6}$	From frequency measured at $T_o$ °C
9	Resistance Variation with Temperature over $T_{op}$	$\frac{\Delta R}{R}$	-10	+ 10	%	From resistance measured at $T_o$ °C
10	Operating Temperature Range	$T_{op}$	-20	+ 70	°C	
11	Frequency variation with Drive Level	$\frac{\Delta f}{f}$	Not applicable		$10^{-6}$	
12	Resistance variation with Drive Level	$\frac{\Delta R}{R}$	Not applicable		%	
13	Motional Inductance	$L_1$	15	22	mH	
14	Motional Capacitance	$C_1$	Not applicable		fF	
15	Static Capacitance	$C_o$	-	7.0	pF	
16	Q Factor	Q	90 000	-	-	
17	Ratio of Unwanted: Response Resistance to Resonance Resistance or Response Impedance to Resonance Resistance	$R_p/R$ or $ Z_p /R$	2:1	-		In the frequency range: $f_r - 50\text{kHz}$ to $f_r + 50\text{kHz}$
18	Ageing	$\frac{\Delta f}{f}$	-3.0	+ 3.0	$10^{-6}$	After burn-in, and per year
19	Terminal Length	L	Figure 2		mm	





**TABLE 1(a) - TYPE VARIANT DETAILED INFORMATION**

TYPE VARIANT NO. 91

No.	Characteristics	Symbol	Limits		Unit	Remarks
			Min.	Max.		
1	Resonance Frequency	$f_r$	24.6827		MHz	Swept
2	Reference Temperature	$T_o$	+24	+26	°C	
3	Overtone Order	-	Fundamental			
4	Load Capacitance	$C_L$	$\infty$		pF	
5	Rated Drive Level	$P_o$	0.1		mW	
6	Frequency Adjustment Tolerance	$\frac{\Delta f}{f}$	-5.0	+5.0	$10^{-6}$	At $T_o$ °C
7	Resonance Resistance	$R_r$	-	10	$\Omega$	At $T_o$ °C
8	Frequency Variation with Temperature over $T_{op}$	$\frac{\Delta f}{f}$	-7.0	+7.0	$10^{-6}$	From frequency measured at $T_o$ °C
9	Resistance Variation with Temperature over $T_{op}$	$\frac{\Delta R}{R}$	-10 or -1.5	+10 +1.5	% $\Omega$	From resistance measured at $T_o$ °C If $R < 10\Omega$
10	Operating Temperature Range	$T_{op}$	-20	+70	°C	
11	Frequency variation with Drive Level	$\frac{\Delta f}{f}$	Not applicable		$10^{-6}$	
12	Resistance variation with Drive Level	$\frac{\Delta R}{R}$	Not applicable		%	
13	Motional Inductance	$L_1$	Not applicable		mH	
14	Motional Capacitance	$C_1$	Not applicable		fF	
15	Static Capacitance	$C_o$	-	5.0	pF	
16	Q Factor	Q	130 000	-	-	
17	Ratio of Unwanted: Response Resistance to Resonance Resistance or Response Impedance to Resonance Resistance	$R_p/R$ or $ Z_p /R$	2:1	-		In the frequency range: $f_r - 200\text{kHz}$ to $f_r + 200\text{kHz}$
18	Ageing	$\frac{\Delta f}{f}$	-3.0	+3.0	$10^{-6}$	After burn-in, and per year
19	Terminal Length	L	Figure 2		mm	



**TABLE 1(a) - TYPE VARIANT DETAILED INFORMATION**

TYPE VARIANT NO. 92

No.	Characteristics	Symbol	Limits		Unit	Remarks
			Min.	Max.		
1	Resonance Frequency	$f_r$	37.839583		MHz	Swept
2	Reference Temperature	$T_o$	+24	+26	°C	
3	Overtone Order	-	3			
4	Load Capacitance	$C_L$	$\infty$		pF	
5	Rated Drive Level	$P_o$	0.1		mW	
6	Frequency Adjustment Tolerance	$\frac{\Delta f}{f}$	-5.0	+5.0	$10^{-6}$	At $T_o$ °C
7	Resonance Resistance	$R_r$	-	40	$\Omega$	At $T_o$ °C
8	Frequency Variation with Temperature over $T_{op}$	$\frac{\Delta f}{f}$	+9.0	-9.0	$10^{-6}$	From frequency measured at $T_o$ °C
9	Resistance Variation with Temperature over $T_{op}$	$\frac{\Delta R}{R}$	-10	+10	%	From resistance measured at $T_o$ °C
10	Operating Temperature Range	$T_{op}$	-20	+70	°C	
11	Frequency variation with Drive Level	$\frac{\Delta f}{f}$	Not applicable		$10^{-6}$	
12	Resistance variation with Drive Level	$\frac{\Delta R}{R}$	Not applicable		%	
13	Motional Inductance	$L_1$	15	22	mH	
14	Motional Capacitance	$C_1$	Not applicable		fF	
15	Static Capacitance	$C_o$	-	7.0	pF	
16	Q Factor	Q	90 000	-	-	
17	Ratio of Unwanted: Response Resistance to Resonance Resistance or Response Impedance to Resonance Resistance	$R_p/R$ or $ Z_p /R$	2:1	-		In the frequency range: $f_r - 50\text{kHz}$ to $f_r + 50\text{kHz}$
18	Ageing	$\frac{\Delta f}{f}$	-3.0	+3.0	$10^{-6}$	After burn-in, and per year
19	Terminal Length	L	Figure 2		mm	



**TABLE 1(a) - TYPE VARIANT DETAILED INFORMATION**

TYPE VARIANT NO. 93

No.	Characteristics	Symbol	Limits		Unit	Remarks
			Min.	Max.		
1	Resonance Frequency	$f_r$	90.875794		MHz	Swept
2	Reference Temperature	$T_o$	+24	+26	°C	
3	Overtone Order	-	5			
4	Load Capacitance	$C_L$	$\infty$		pF	
5	Rated Drive Level	$P_o$	0.1		mW	
6	Frequency Adjustment Tolerance	$\frac{\Delta f}{f}$	-5.0	+5.0	$10^{-6}$	At $T_o$ °C
7	Resonance Resistance	$R_r$	-	45	$\Omega$	At $T_o$ °C
8	Frequency Variation with Temperature over $T_{op}$	$\frac{\Delta f}{f}$	-9.0	+9.0	$10^{-6}$	From frequency measured at $T_o$ °C
9	Resistance Variation with Temperature over $T_{op}$	$\frac{\Delta R}{R}$	-20	+20	%	From resistance measured at $T_o$ °C
10	Operating Temperature Range	$T_{op}$	-20	+70	°C	
11	Frequency variation with Drive Level	$\frac{\Delta f}{f}$	Not applicable		$10^{-6}$	
12	Resistance variation with Drive Level	$\frac{\Delta R}{R}$	Not applicable		%	
13	Motional Inductance	$L_1$	6.5	-	mH	
14	Motional Capacitance	$C_1$	Not applicable		fF	
15	Static Capacitance	$C_o$	-	3.0	pF	
16	Q Factor	Q	105 000	-	-	
17	Ratio of Unwanted: Response Resistance to Resonance Resistance or Response Impedance to Resonance Resistance	$R_p/R$ $ Z_{pl}/R$	2:1	-		In the frequency range: $f_r - 50\text{kHz}$ to $f_r + 50\text{kHz}$
18	Ageing	$\frac{\Delta f}{f}$	-3.0	+3.0	$10^{-6}$	After burn-in, and per year
19	Terminal Length	L	Figure 2		mm	



**TABLE 1(a) - TYPE VARIANT DETAILED INFORMATION**

TYPE VARIANT NO. 94

No.	Characteristics	Symbol	Limits		Unit	Remarks
			Min.	Max.		
1	Resonance Frequency	$f_r$	90.881675		MHz	Swept
2	Reference Temperature	$T_o$	+24	+26	°C	
3	Overtone Order	-	5			
4	Load Capacitance	$C_L$	$\infty$		pF	
5	Rated Drive Level	$P_o$	0.1		mW	
6	Frequency Adjustment Tolerance	$\frac{\Delta f}{f}$	-5.0	+5.0	$10^{-6}$	At $T_o$ °C
7	Resonance Resistance	$R_r$	-	45	$\Omega$	At $T_o$ °C
8	Frequency Variation with Temperature over $T_{op}$	$\frac{\Delta f}{f}$	-9.0	+9.0	$10^{-6}$	From frequency measured at $T_o$ °C
9	Resistance Variation with Temperature over $T_{op}$	$\frac{\Delta R}{R}$	-20	+20	%	From resistance measured at $T_o$ °C
10	Operating Temperature Range	$T_{op}$	-20	+70	°C	
11	Frequency variation with Drive Level	$\frac{\Delta f}{f}$	Not applicable		$10^{-6}$	
12	Resistance variation with Drive Level	$\frac{\Delta R}{R}$	Not applicable		%	
13	Motional Inductance	$L_1$	6.5	-	mH	
14	Motional Capacitance	$C_1$	Not applicable		fF	
15	Static Capacitance	$C_o$	-	3.0	pF	
16	Q Factor	Q	105 000	-	-	
17	Ratio of Unwanted: Response Resistance to Resonance Resistance or Response Impedance to Resonance Resistance	$R_p/R$ or $ Z_p /R$	2:1	-		In the frequency range: $f_r -50kHz$ to $f_r +50kHz$
18	Ageing	$\frac{\Delta f}{f}$	-3.0	+3.0	$10^{-6}$	After burn-in, and per year
19	Terminal Length	L	Figure 2		mm	



**TABLE 1(a) - TYPE VARIANT DETAILED INFORMATION**

TYPE VARIANT NO. 95

No.	Characteristics	Symbol	Limits		Unit	Remarks
			Min.	Max.		
1	Resonance Frequency	$f_r$	90.88754		MHz	Swept
2	Reference Temperature	$T_o$	+24	+26	°C	
3	Overtone Order	-	5			
4	Load Capacitance	$C_L$	$\infty$		pF	
5	Rated Drive Level	$P_o$	0.1		mW	
6	Frequency Adjustment Tolerance	$\frac{\Delta f}{f}$	-5.0	+5.0	$10^{-6}$	At $T_o$ °C
7	Resonance Resistance	$R_r$	-	45	$\Omega$	At $T_o$ °C
8	Frequency Variation with Temperature over $T_{op}$	$\frac{\Delta f}{f}$	-9.0	+9.0	$10^{-6}$	From frequency measured at $T_o$ °C
9	Resistance Variation with Temperature over $T_{op}$	$\frac{\Delta R}{R}$	-20	+20	%	From resistance measured at $T_o$ °C
10	Operating Temperature Range	$T_{op}$	-20	+70	°C	
11	Frequency variation with Drive Level	$\frac{\Delta f}{f}$	Not applicable		$10^{-6}$	
12	Resistance variation with Drive Level	$\frac{\Delta R}{R}$	Not applicable		%	
13	Motional Inductance	$L_1$	6.5	-	mH	
14	Motional Capacitance	$C_1$	Not applicable		fF	
15	Static Capacitance	$C_o$	-	3.0	pF	
16	Q Factor	Q	105 000	-	-	
17	Ratio of Unwanted: Response Resistance to Resonance Resistance or Response Impedance to Resonance Resistance	$R_p/R$ $ Z_p /R$	2:1	-		In the frequency range: $f_r - 50\text{kHz}$ to $f_r + 50\text{kHz}$
18	Ageing	$\frac{\Delta f}{f}$	-3.0	+3.0	$10^{-6}$	After burn-in, and per year
19	Terminal Length	L	Figure 2		mm	



**TABLE 1(a) - TYPE VARIANT DETAILED INFORMATION**

**TYPE VARIANT NO. 96**

No.	Characteristics	Symbol	Limits		Unit	Remarks
			Min.	Max.		
1	Resonance Frequency	$f_r$	90.893413		MHz	Swept
2	Reference Temperature	$T_o$	+24	+26	°C	
3	Overtone Order	-	5			
4	Load Capacitance	$C_L$	$\infty$		pF	
5	Rated Drive Level	$P_o$	0.1		mW	
6	Frequency Adjustment Tolerance	$\frac{\Delta f}{f}$	-5.0	+5.0	$10^{-6}$	At $T_o$ °C
7	Resonance Resistance	$R_r$	-	45	$\Omega$	At $T_o$ °C
8	Frequency Variation with Temperature over $T_{op}$	$\frac{\Delta f}{f}$	-9.0	+9.0	$10^{-6}$	From frequency measured at $T_o$ °C
9	Resistance Variation with Temperature over $T_{op}$	$\frac{\Delta R}{R}$	-20	+20	%	From resistance measured at $T_o$ °C
10	Operating Temperature Range	$T_{op}$	-20	+70	°C	
11	Frequency variation with Drive Level	$\frac{\Delta f}{f}$	Not applicable		$10^{-6}$	
12	Resistance variation with Drive Level	$\frac{\Delta R}{R}$	Not applicable		%	
13	Motional Inductance	$L_1$	6.5	-	mH	
14	Motional Capacitance	$C_1$	Not applicable		fF	
15	Static Capacitance	$C_o$	-	3.0	pF	
16	Q Factor	Q	105 000	-	-	
17	Ratio of Unwanted: Response Resistance to Resonance Resistance or Response Impedance to Resonance Resistance	$R_p/R$ $ Z_p /R$	2:1	-		In the frequency range: $f_r - 50\text{kHz}$ to $f_r + 50\text{kHz}$
18	Ageing	$\frac{\Delta f}{f}$	-3.0	+3.0	$10^{-6}$	After burn-in, and per year
19	Terminal Length	L	Figure 2		mm	



**TABLE 1(a) - TYPE VARIANT DETAILED INFORMATION**

TYPE VARIANT NO. 97

No.	Characteristics	Symbol	Limits		Unit	Remarks
			Min.	Max.		
1	Resonance Frequency	$f_r$	99.53704		MHz	Swept
2	Reference Temperature	$T_o$	+24	+26	°C	
3	Overtone Order	-	5			
4	Load Capacitance	$C_L$	$\infty$		pF	
5	Rated Drive Level	$P_o$	0.1		mW	
6	Frequency Adjustment Tolerance	$\frac{\Delta f}{f}$	-5.0	+5.0	$10^{-6}$	At $T_o$ °C
7	Resonance Resistance	$R_r$	-	45	$\Omega$	At $T_o$ °C
8	Frequency Variation with Temperature over $T_{op}$	$\frac{\Delta f}{f}$	+9.0	-9.0	$10^{-6}$	From frequency measured at $T_o$ °C
9	Resistance Variation with Temperature over $T_{op}$	$\frac{\Delta R}{R}$	-20	+20	%	From resistance measured at $T_o$ °C
10	Operating Temperature Range	$T_{op}$	-20	+70	°C	
11	Frequency variation with Drive Level	$\frac{\Delta f}{f}$	Not applicable		$10^{-6}$	
12	Resistance variation with Drive Level	$\frac{\Delta R}{R}$	Not applicable		%	
13	Motional Inductance	$L_1$	4.9	-	mH	
14	Motional Capacitance	$C_1$	Not applicable		fF	
15	Static Capacitance	$C_o$	-	3.0	pF	
16	Q Factor	Q	95 000	-	-	
17	Ratio of Unwanted: Response Resistance to Resonance Resistance or Response Impedance to Resonance Resistance	$R_p/R$ $ Z_p /R$	2:1	-		In the frequency range: $f_r -50kHz$ to $f_r +50kHz$
18	Ageing	$\frac{\Delta f}{f}$	-3.0	+3.0	$10^{-6}$	After burn-in, and per year
19	Terminal Length	L	Figure 2		mm	



**TABLE 1(a) - TYPE VARIANT DETAILED INFORMATION**

**TYPE VARIANT NO. 98**

No.	Characteristics	Symbol	Limits		Unit	Remarks
			Min.	Max.		
1	Resonance Frequency	$f_r$	20.0		MHz	
2	Reference Temperature	$T_o$	+25		°C	
3	Overtone Order	-	Fundamental			
4	Load Capacitance	$C_L$	$\infty$		pF	
5	Rated Drive Level	$P_o$	0.1		mW	
6	Frequency Adjustment Tolerance	$\frac{\Delta f}{f}$	-50	+50	$10^{-6}$	At $T_o$ °C
7	Resonance Resistance	$R_r$	-	30	$\Omega$	Over $T_{op}$ °C
8	Frequency Variation with Temperature over $T_{op}$	$\frac{\Delta f}{f}$	-50	+50	$10^{-6}$	From frequency measured at $T_o$ °C
9	Resistance Variation with Temperature over $T_{op}$	$\frac{\Delta R}{R}$	Not applicable		%	From resistance measured at $T_o$ °C
10	Operating Temperature Range	$T_{op}$	-55	+105	°C	
11	Frequency variation with Drive Level	$\frac{\Delta f}{f}$	Not applicable		$10^{-6}$	
12	Resistance variation with Drive Level	$\frac{\Delta R}{R}$	Not applicable		%	
13	Motional Inductance	$L_1$	Not applicable		mH	
14	Motional Capacitance	$C_1$	Not applicable		fF	
15	Static Capacitance	$C_o$	-	7.0	pF	
16	Q Factor	Q	Not applicable		-	
17	Ratio of Unwanted: Response Resistance to Resonance Resistance or Response Impedance to Resonance Resistance	$R_p/R$ $ Z_p /R$	7:1	-		In the frequency range: $f_r - 1.0\text{MHz}$ to $f_r + 1.0\text{MHz}$
18	Ageing	$\frac{\Delta f}{f}$	-7.5	+7.5	$10^{-6}$	After burn-in, per year
19	Terminal Length	L	Figure 2		mm	





**TABLE 1(a) - TYPE VARIANT DETAILED INFORMATION**

TYPE VARIANT NO. 99

No.	Characteristics	Symbol	Limits		Unit	Remarks
			Min.	Max.		
1	Resonance Frequency	$f_L$	24.5		MHz	
2	Reference Temperature	$T_o$	+20	+30	°C	
3	Overtone Order	-	Fundamental			
4	Load Capacitance	$C_L$	32		pF	
5	Rated Drive Level	$P_o$	0.2		mW	
6	Frequency Adjustment Tolerance	$\frac{\Delta f}{f}$	-5.0	+5.0	$10^{-6}$	At $T_o$ °C
7	Resonance Resistance	$R_L$	-	21	$\Omega$	At $T_o$ °C
8	Frequency Variation with Temperature over $T_{op}$	$\frac{\Delta f}{f}$	-7.0	+7.0	$10^{-6}$	From frequency measured at $T_o$ °C
9	Resistance Variation with Temperature over $T_{op}$	$\frac{\Delta R}{R}$	-10	+10	%	From resistance measured at $T_o$ °C If $R < 10\Omega$
			-1.5	+1.5	$\Omega$	
10	Operating Temperature Range	$T_{op}$	-20	+70	°C	
11	Frequency variation with Drive Level	$\frac{\Delta f}{f}$	Not applicable		$10^{-6}$	
12	Resistance variation with Drive Level	$\frac{\Delta R}{R}$	-10	+10	%	From $P_{S1} = 0.01mW$ to $P_{S2} = 0.5mW$
13	Motional Inductance	$L_1$	-	6.93	mH	
14	Motional Capacitance	$C_1$	Not applicable		fF	
15	Static Capacitance	$C_o$	-	3.0	pF	
16	Q Factor	Q	60 000	-	-	
17	Ratio of Unwanted: Response Resistance to Resonance Resistance or Response Impedance to Resonance Resistance	$R_p/R$ $ Z_p /R$	3:1	-		In the frequency range: $f_L -500kHz$ to $f_L +500kHz$
18	Ageing	$\frac{\Delta f}{f}$	-50	+5.0	$10^{-6}$	After burn-in, over 10 years
19	Terminal Length	L	Figure 2		mm	