



europaean space agency
agence spatiale européenne

Pages 1 to 23

**CONNECTOR SAVERS FOR
ELECTRICAL, CIRCULAR CONNECTORS
3401/044, 3401/052 AND 3401/056
ESA/SCC Detail Specification No. 3401/063**



**space components
coordination group**

Issue/Rev.	Date	Approved by	
		SCCG Chairman	ESA Director General or his Deputy
Issue 1	September 1994	<i>[Signature]</i>	<i>[Signature]</i>
Revision 'A'	September 1998	<i>[Signature]</i>	<i>[Signature]</i> pp R Gieschi

DOCUMENTATION CHANGE NOTICE

Rev. Letter	Rev. Date	Reference	CHANGE Item	Approved DCR No.
'A'	Sept. '98	P1. Cover page		None
		P2. DCN		None
		P19. Para. 4.4.1 : Plating amended		221489
		P20. Para. 4.5.4 : In the text , Item "(a)" amended		221489
		, New Item "(b)" added and all subsequent		23896
		Items renumbered		
		Para. 4.5.4.1 : Existing text amended and new text added		221489
Para. 4.5.4.2 : Moved to Page 21		None		
P21. Para. 4.5.4.2 : Added from Page 20		None		

 SCC	ESA/SCC Detail Specification No. 3401/063		PAGE 3 ISSUE 1
--	--	--	-------------------

TABLE OF CONTENTS

		<u>Page</u>
1.	<u>GENERAL</u>	5
1.1	Scope	5
1.2	Range of Components	5
1.3	Maximum Ratings	5
1.4	Parameter Derating Information	5
1.5	Physical Dimensions	5
2.	<u>APPLICABLE DOCUMENTS</u>	5
3.	<u>TERMS, DEFINITIONS, ABBREVIATIONS, SYMBOLS AND UNITS</u>	18
4.	<u>REQUIREMENTS</u>	18
4.1	General	18
4.2	Deviations from Generic Specification	18
4.2.1	Deviations from Special In-process Controls	18
4.2.2	Deviations from Final Production Tests	18
4.2.3	Deviations from Burn-in and Electrical Measurements	18
4.2.4	Deviations from Qualification Tests	18
4.2.5	Deviations from Lot Acceptance Tests	18
4.3	Mechanical Requirements	18
4.3.1	Dimension Check	18
4.3.2	Weight	18
4.3.3	Contact Capability	18
4.3.4	Contact Retention	19
4.3.5	Mating and Unmating Forces	19
4.3.6	Insert Retention	19
4.3.7	Jackscrew Retention	19
4.3.8	Contact Insertion and Withdrawal Forces	19
4.3.9	Engagement and Separation Forces	19
4.3.10	Oversize Pin Exclusion	19
4.3.11	Probe Damage	19
4.3.12	Solderability	19
4.4	Materials and Finishes	19
4.4.1	Shell, Coupling Ring and Nuts	19
4.4.2	Inserts	19
4.4.3	Contacts	19
4.4.4	Contact Retaining Clip	19
4.4.5	Guiding and Locking Devices	19
4.4.6	Magnetism Level	20
4.5	Marking	20
4.5.1	General	20
4.5.2	Contact Identification	20
4.5.3	The SCC Component Number	20
4.5.4	Characteristics	20
4.5.5	Traceability Information	21
4.5.6	Marking of Small Components	22
4.6	Electrical Measurements	22
4.6.1	Electrical Measurements at Room Temperature	22
4.6.2	Electrical Measurements at High and Low Temperatures	22
4.6.3	Circuit for Electrical Measurements	22
4.7	Burn-in and Electrical Measurements	22
4.8	Environmental and Endurance Tests	22



TABLES

	<u>Page</u>
1(a) Range of Components	6
1(b) Maximum Ratings	7
2 Electrical Measurements at Room Temperature	23
3 Not applicable	N/A
4 Not applicable	N/A
5 Not applicable	N/A
6 Not applicable	N/A

FIGURES

1 Parameter Derating Information	N/A
2 Physical Dimensions	8
2(a) Physical Dimensions - Savers	8
2(b) Physical Dimensions - Contact Arrangements	11
2(c) Physical Dimensions - Clacking Positions	17

APPENDICES (Applicable to specific Manufacturers only)

None.

**1. GENERAL****1.1 SCOPE**

This specification details the ratings, physical and electrical characteristics, test and inspection data for Connector Savers for Electrical, Circular Connectors 3401/044, 3401/052 and 3401/056.

It shall be read in conjunction with:

- ESA/SCC Generic Specification No. 3401, Connectors, Electrical, Non-Filtered, Circular and Rectangular.
- ESA/SCC Detail Specification No. 3401/044, Connectors, Electrical, Circular Bayonet Coupling, Removable Crimp Contacts, Based on MIL-C-38999 Series II.
- ESA/SCC Detail Specification No. 3401/052, Connectors, Electrical, Circular Bayonet Coupling, Scoop-proof, Removable Crimp Contacts, Based on MIL-C-38999 Series I.
- ESA/SCC Detail Specification No. 3401/056, Connectors, Electrical, Triple Start Self Locking Coupling, Scoop-proof, Removable Crimp Contacts, Based on MIL-C-38999 Series III.

the requirements of which are supplemented herein.

1.2 RANGE OF COMPONENTS

The different sizes of connectors specified herein, which are also covered by this specification, together with their mechanical characteristics, are given in Table 1(a).

1.3 MAXIMUM RATINGS

The maximum ratings, which shall not be exceeded at any time during use or storage, applicable to the connector savers specified herein, are scheduled in Table 1(b).

1.4 PARAMETER DERATING INFORMATION (FIGURE 1)

Not applicable.

1.5 PHYSICAL DIMENSIONS

The physical dimensions of the connectors specified herein are shown in Figure 2.

2. APPLICABLE DOCUMENTS

The following documents form part of this specification and shall be read in conjunction with it:-

- (a) ESA/SCC Generic Specification No. 3401, Connectors, Electrical, Non-Filtered, Circular and Rectangular.
- (b) ESA/SCC Detail Specification No. 3401/044, Connectors, Electrical, Circular Bayonet Coupling, Removable Crimp Contacts, Based on MIL-C-38999 Series II.
- (c) ESA/SCC Detail Specification No. 3401/052, Connectors, Electrical, Circular Bayonet Coupling, Scoop-proof, Removable Crimp Contacts, Based on MIL-C-38999 Series I.
- (d) ESA/SCC Detail Specification No. 3401/056, Connectors, Electrical, Triple Start Self Locking Coupling, Scoop-proof, Removable Crimp Contacts, Based on MIL-C-38999 Series III.
- (e) MIL-STD-1560, Insert Arrangements for MIL-C-38999 and MIL-C-27599 Electrical Circular Connectors.



TABLE 1(a) - RANGE OF COMPONENTS

TYPE VARIANT 01 - Savers for 3401/052 Connectors (Series I)

SHELL SIZE	MAX. WEIGHT (g) (1)	MATING TORQUE FOR THE PLUG END MAX. N.m	UNMATING TORQUE FOR THE PLUG END	
			MAX. N.m	MIN. N.m
09	25	0.9	0.9	0.2
11	32	1.4	1.4	0.2
13	38	1.8	1.8	0.2
15	45	2.3	2.3	0.3
17	52	2.7	2.7	0.3
19	83	3.2	3.2	0.3
21	105	3.6	3.6	0.6
23	113	4.1	4.1	0.6
25	117	4.6	4.6	0.6

NOTES

1. With contacts.

TYPE VARIANT 02 - Savers for 3401/044 Connectors (Series II)

SHELL SIZE	MAX. WEIGHT (g) (1)	MATING TORQUE FOR THE PLUG END MAX. N.m	UNMATING TORQUE FOR THE PLUG END	
			MAX. N.m	MIN. N.m
08	18	0.9	0.9	0.2
10	28	1.4	1.4	0.2
12	34	1.8	1.8	0.2
14	40	2.3	2.3	0.3
16	46	2.7	2.7	0.3
18	76	3.2	3.2	0.3
20	95	3.6	3.6	0.6
22	106	4.1	4.1	0.6
24	112	4.6	4.6	0.6

NOTES

1. With contacts.

**TABLE 1(a) - RANGE OF COMPONENTS (CONTINUED)**

TYPE VARIANT 03 - Savers for 3401/056 Connectors (Series III)

SHELL SIZE	MAX. WEIGHT (g) (1)	MATING AND UNMATING AXIAL FORCE FOR THE PLUG END (N)		MATING TORQUE FOR THE PLUG END MAX. N.m	UNMATING TORQUE FOR THE PLUG END	
		MIN	MAX		MAX. N.m	MIN. N.m
09	23	2.0	111	0.9	0.9	0.2
11	32	2.0	111	1.4	1.4	0.2
13	36	2.0	133	1.8	1.8	0.2
15	44	2.0	133	2.3	2.3	0.3
17	51	2.0	156	2.7	2.7	0.3
19	80	2.0	156	3.2	3.2	0.3
21	100	2.0	156	3.6	3.6	0.6
23	111	2.0	156	4.1	4.1	0.6
25	115	2.0	156	4.6	4.6	0.6

NOTES

1. With contacts.

TABLE 1(b) - MAXIMUM RATINGS

No.	CHARACTERISTICS	SYMBOL	MAXIMUM RATING		UNIT	
			MIN	MAX		
1	Working Voltage (Sea Level) (1)	Service rating N Service rating M Service rating I Service rating II	U_R	-	250	Vrms
				-	325	
				-	450	
				-	575	
2	Operating Temperature Range	T_{op}	- 65	+ 200	°C	
3	Storage Temperature Range	T_{stg}	- 65	+ 200	°C	

NOTES

1. See Para. 4.5.4.3.

FIGURE 1 - PARAMETER DERATING INFORMATION

Not applicable.



FIGURE 2 - PHYSICAL DIMENSIONS

**FIGURE 2(a) - SAVERS
TYPE VARIANT 01 - SAVERS FOR 3401/052 CONNECTORS (SERIES I)**

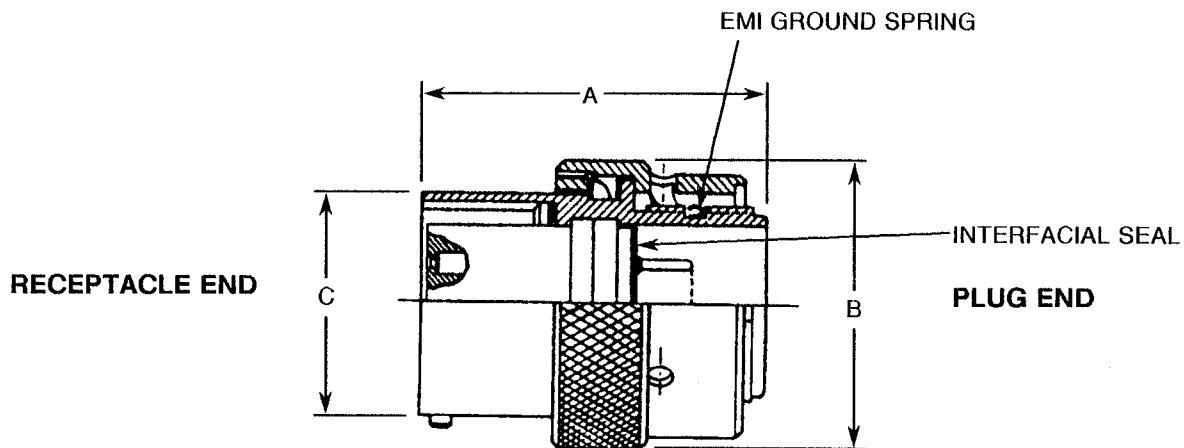

SHELL SIZE	09	11	13	15	17	19	21	23	25
A Max	38.10	38.10	38.10	38.10	38.10	38.10	38.10	38.10	38.10
B Max	22.86	26.16	30.61	33.66	36.83	39.75	42.93	45.59	48.77
C Max	14.60	17.80	21.60	24.80	28.00	30.70	33.90	37.00	40.20

NOTES

1. All dimensions are in millimetres.



FIGURE 2 - PHYSICAL DIMENSIONS (CONTINUED)

**FIGURE 2(a) - SAVERS
TYPE VARIANT 02 - SAVERS FOR 3401/044 CONNECTORS (SERIES II)**

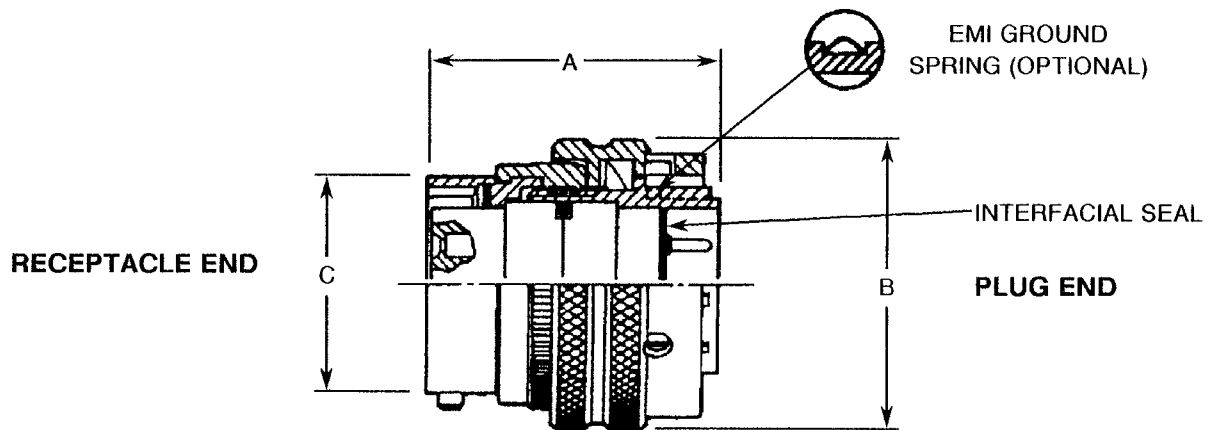

SHELL SIZE	08	10	12	14	16	18	20	22	24
A Max	30.50	30.50	30.50	30.50	30.50	30.50	30.50	30.50	30.50
B Max	19.10	21.80	26.20	29.40	32.50	35.70	38.90	41.70	44.90
C Max	12.00	15.00	13.10	22.30	25.40	28.60	31.80	35.00	38.10

NOTES

1. All dimensions are in millimetres.



FIGURE 2 - PHYSICAL DIMENSIONS (CONTINUED)

FIGURE 2(a) - SAVERS

TYPE VARIANT 03 - SAVERS FOR 3401/056 CONNECTORS (SERIES III)

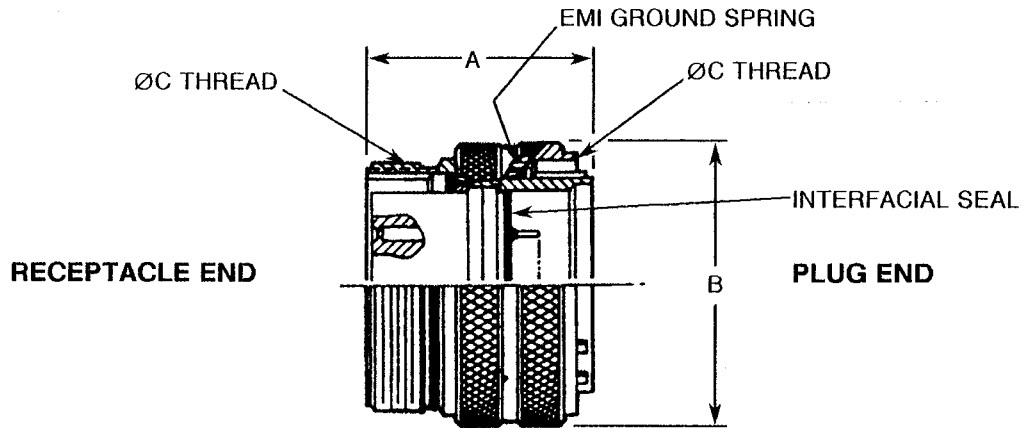

SHELL SIZE	MILLIMETRES		ØC THREAD (CLASS 2A)
	A Max	B Max	
09	38.10	21.80	0.6250-0.1P-0.3L-TS-2
11	38.10	24.60	0.7500-0.1P-0.3L-TS-2
13	38.10	29.00	0.8750-0.1P-0.3L-TS-2
15	38.10	32.20	1.0000-0.1P-0.3L-TS-2
17	38.10	35.30	1.1875-0.1P-0.3L-TS-2
19	38.10	38.10	1.2500-0.1P-0.3L-TS-2
21	38.10	41.30	1.3750-0.1P-0.3L-TS-2
23	38.10	44.50	1.5000-0.1P-0.3L-TS-2
25	38.10	47.60	1.6250-0.1P-0.3L-TS-2



FIGURE 2 - PHYSICAL DIMENSIONS (CONTINUED)

FIGURE 2(b) - HIGH DENSITY CONTACT ARRANGEMENTS - FRONT VIEW MALE INSERT
TYPE VARIANT 01 - SAVERS FOR 3401/052 CONNECTORS (SERIES I)
TYPE VARIANT 03 - SAVERS FOR 3401/056 CONNECTORS (SERIES III)

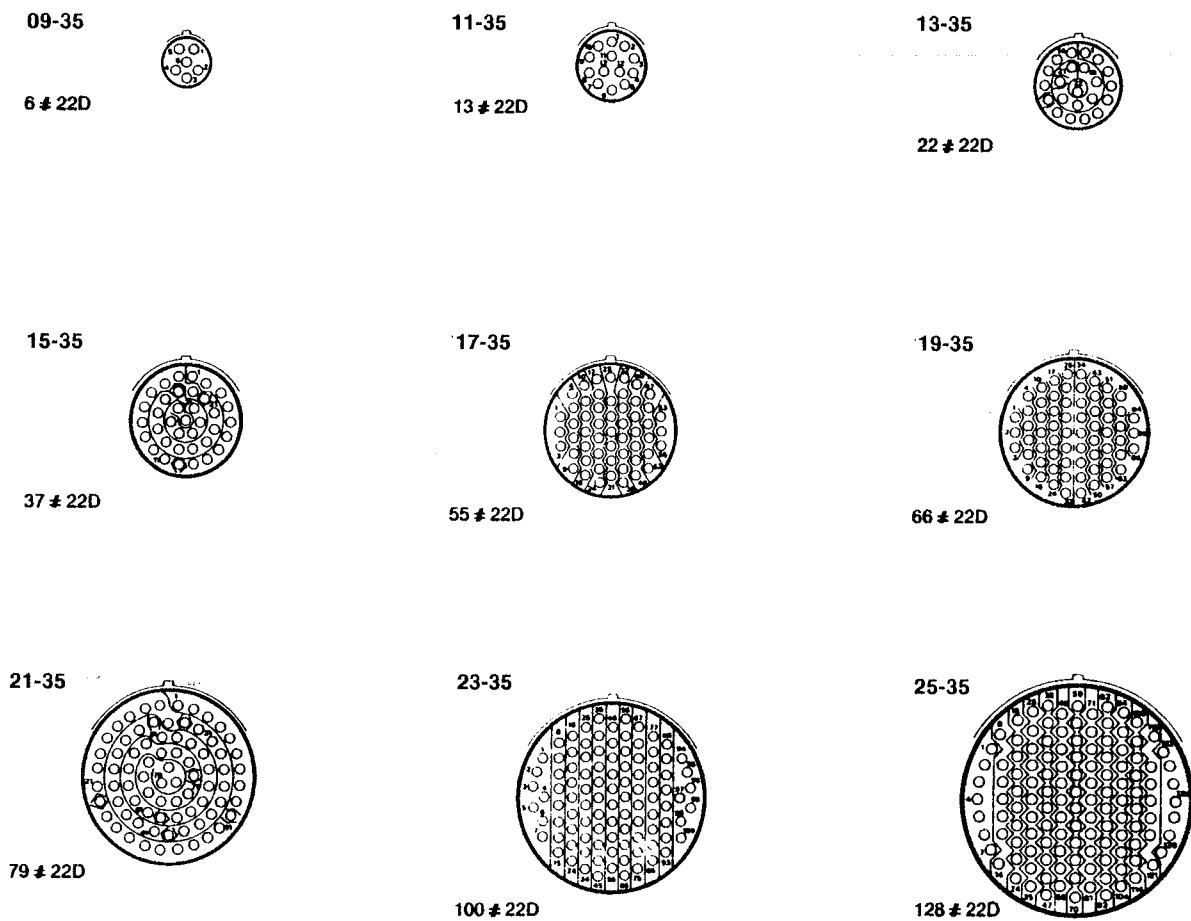

NOTES

1. Contact locations and identifications in conformity with MIL-STD-1560.
2. Both sides of the inserts shall be marked.

FIGURE 2 - PHYSICAL DIMENSIONS (CONTINUED)

FIGURE 2(b) - STANDARD CONTACT ARRANGEMENTS - FRONT VIEW MALE INSERT
TYPE VARIANT 01 - SAVERS FOR 3401/052 CONNECTORS (SERIES I)
TYPE VARIANT 03 - SAVERS FOR 3401/056 CONNECTORS (SERIES III)

09-98

3 # 20



11-98

6 # 20



13-98

10 # 20



15-19

19 # 20



17-26

26 # 20

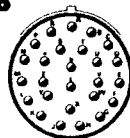

19-32

32 # 20

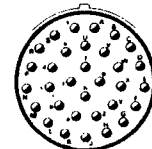

21-41

41 # 20

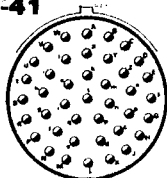

23-53

53 # 20

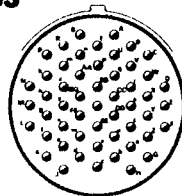

25-61

61 # 20

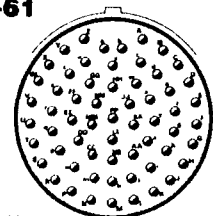

NOTES

1. Contact locations and identifications in conformity with MIL-STD-1560.
2. Both sides of the inserts shall be marked.



FIGURE 2 - PHYSICAL DIMENSIONS (CONTINUED)

**FIGURE 2(b) - SPECIAL CONTACT ARRANGEMENTS - FRONT VIEW MALE INSERT
TYPE VARIANT 01 - SAVERS FOR 3401/052 CONNECTORS (SERIES I)
TYPE VARIANT 03 - SAVERS FOR 3401/056 CONNECTORS (SERIES III)**

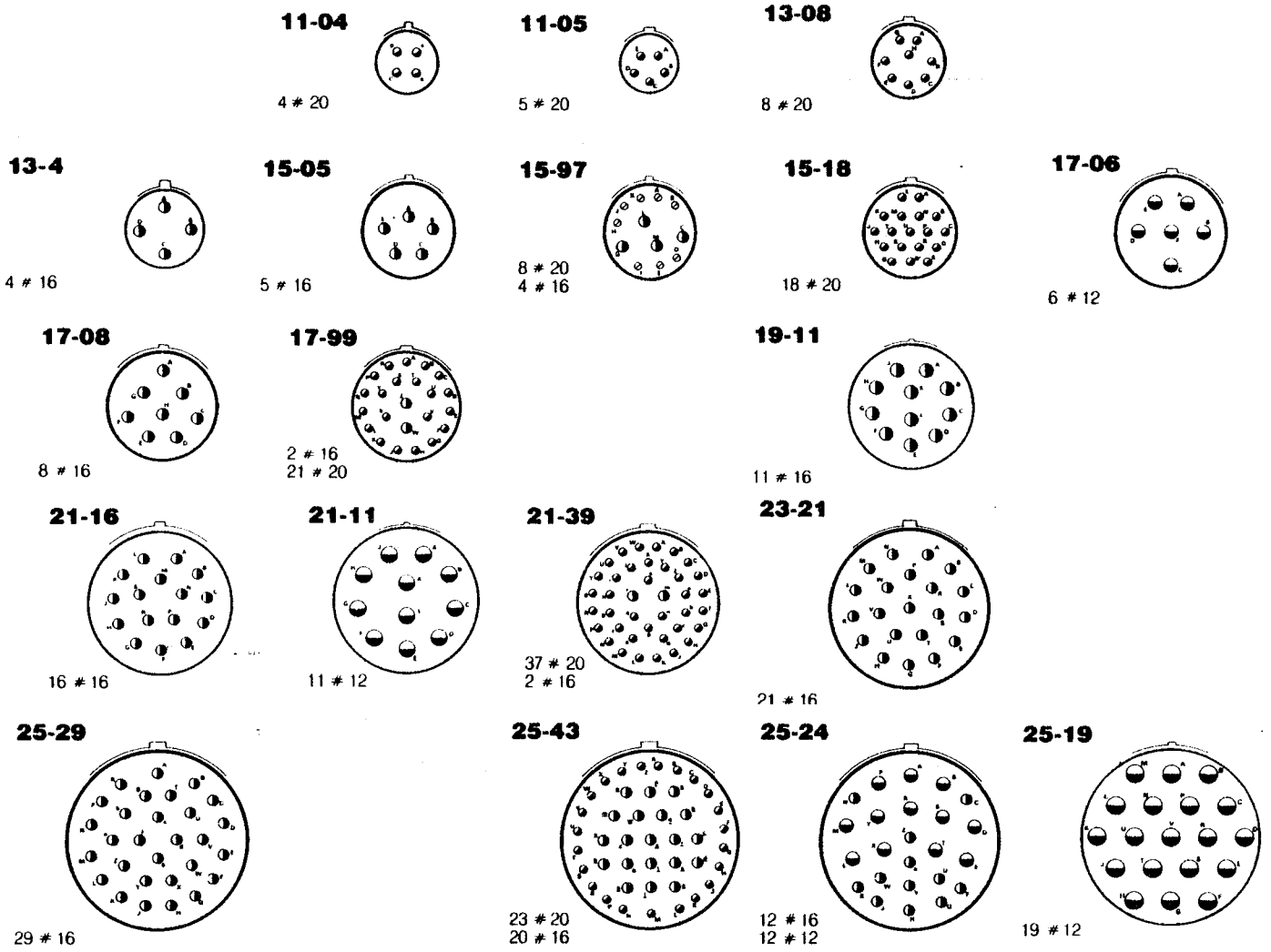

NOTES

1. Contact locations and identifications in conformity with MIL-STD-1560.
2. Both sides of the inserts shall be marked.

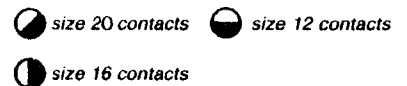



FIGURE 2 - PHYSICAL DIMENSIONS (CONTINUED)

**FIGURE 2(b) - HIGH DENSITY CONTACT ARRANGEMENTS - FRONT VIEW MALE INSERT
TYPE VARIANT 02 - SAVERS FOR 3401/044 CONNECTORS (SERIES II)**

08-35



6 # 22D

10-35



13 # 22D

12-35

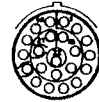

22 # 22D

14-35

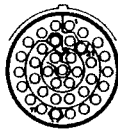

37 # 22D

16-35

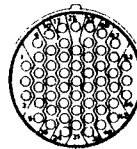

55 # 22D

18-35

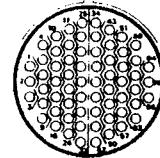

66 # 22D

20-35

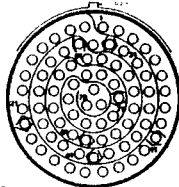

79 # 22D

22-35

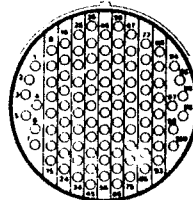

100 # 22D

24-35

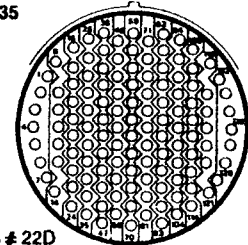

128 # 22D

NOTES

1. Contact locations and identifications in conformity with MIL-STD-1560.
2. Both sides of the inserts shall be marked.



FIGURE 2 - PHYSICAL DIMENSIONS (CONTINUED)

**FIGURE 2(b) - SPECIAL CONTACT ARRANGEMENTS - FRONT VIEW MALE INSERT
TYPE VARIANT 02 - SAVERS FOR 3401/044 CONNECTORS (SERIES II)**

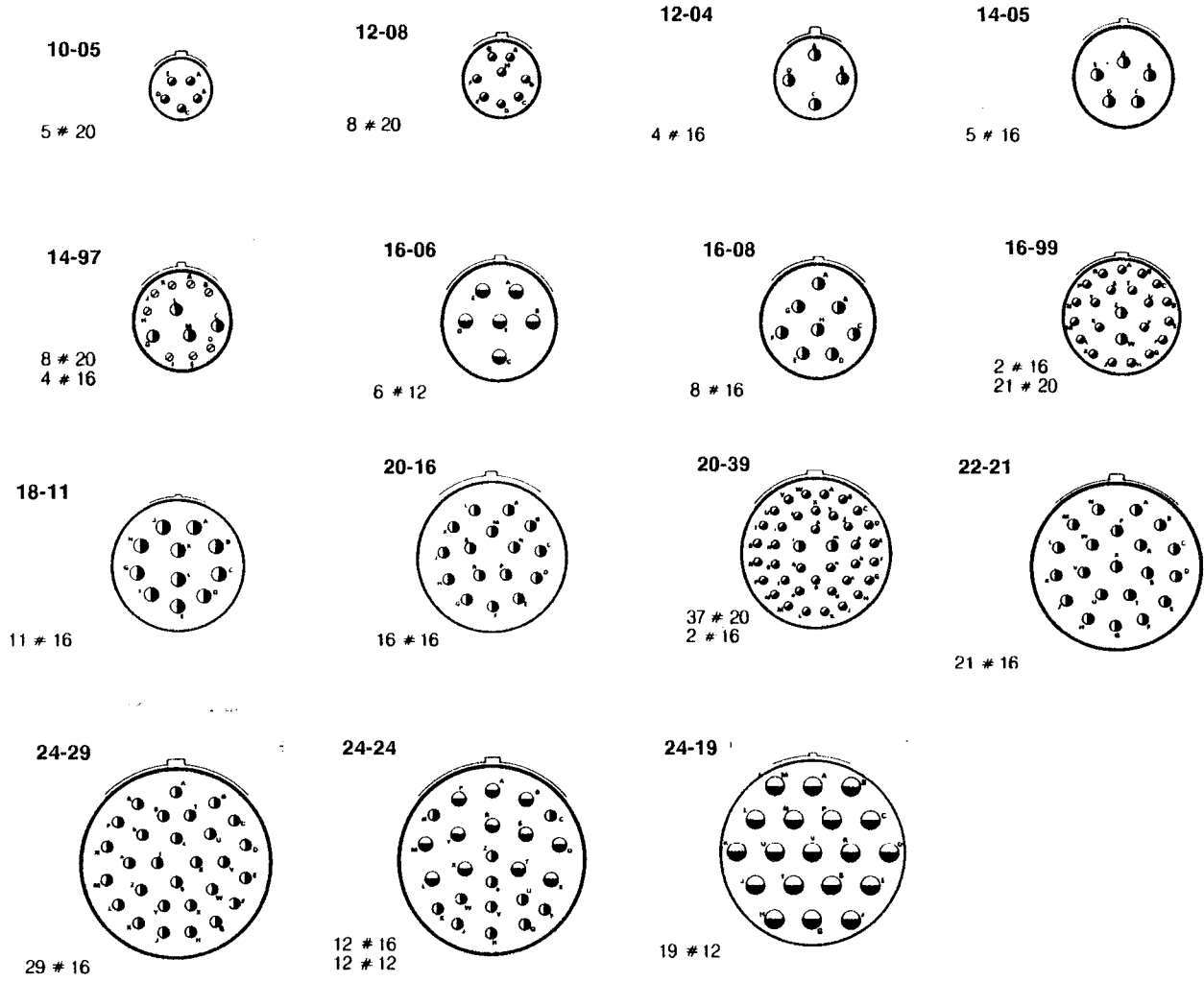

NOTES

- Contact locations and identifications in conformity with MIL-STD-1560.
- Both sides of the inserts shall be marked.



 contacts # 20
 size 20 contacts
  contacts # 12
 size 12 contacts
 contacts # 16
 size 16 contacts



FIGURE 2 - PHYSICAL DIMENSIONS (CONTINUED)

**FIGURE 2(b) - STANDARD CONTACT ARRANGEMENTS - FRONT VIEW MALE INSERT
TYPE VARIANT 02 - SAVERS FOR 3401/044 CONNECTORS (SERIES II)**

08-98

3 # 20



10-98

6 # 20



12-98

10 # 20



14-18

18 # 20

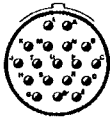

16-26

26 # 20

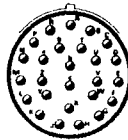

18-32

32 # 20

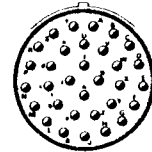

20-41

41 # 20

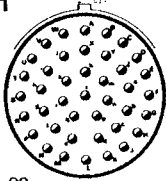

22-55

55 # 20



24-61

61 # 20

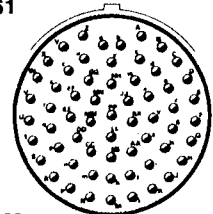

NOTES

1. Contact locations and identifications in conformity with MIL-STD-1560.
2. Both sides of the inserts shall be marked.



FIGURE 2 - PHYSICAL DIMENSIONS (CONTINUED)

FIGURE 2(c) - CLOCKING POSITIONS

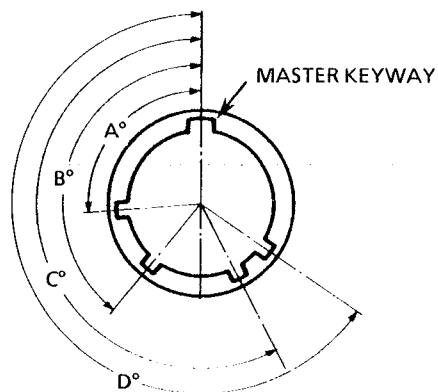

Receptacle front end view

NOTES

1. The clocking position is determined by the different angles of the secondary keyways, the insert being always in the same position with respect to the master keyway position which is fixed.

SHELL SIZE	ANGLES	CLOCKING POSITIONS					
		N	A	B	C	D	E
09	A°	105	102	80	35	64	91
	B°	140	132	118	140	155	131
	C°	215	248	230	205	234	197
	D°	265	320	312	275	304	240
11	A°	95	113	90	53	119	51
	B°	141	156	145	156	146	141
	C°	208	182	195	220	176	184
	D°	236	292	252	255	298	242
13	A°	95	113	90	53	119	51
	B°	141	156	145	156	146	141
	C°	208	182	195	220	176	184
	D°	236	292	252	255	298	242
15	A°	95	113	90	53	119	51
	B°	141	156	145	156	146	141
	C°	208	182	195	220	176	184
	D°	236	292	252	255	298	242
17	A°	80	135	49	66	62	79
	B°	142	170	169	140	145	153
	C°	196	200	200	200	180	197
	D°	293	310	244	257	280	272
19	A°	80	135	49	66	62	79
	B°	142	170	169	140	145	153
	C°	196	200	200	200	180	197
	D°	293	310	244	257	280	272
21	A°	80	135	49	66	62	79
	B°	142	170	169	140	145	153
	C°	196	200	200	200	180	197
	D°	293	310	244	257	280	272
23	A°	80	135	49	66	62	79
	B°	142	170	169	140	145	153
	C°	196	200	200	200	180	197
	D°	293	310	244	257	280	272
25	A°	80	135	49	66	62	79
	B°	142	170	169	140	145	153
	C°	196	200	200	200	180	197
	D°	293	310	244	257	280	272

	<p style="text-align: center;">ESA/SCC Detail Specification No. 3401/063</p>	<p style="text-align: right;">PAGE 18 ISSUE 1</p>
---	--	---

3. TERMS, DEFINITIONS, ABBREVIATIONS, SYMBOLS AND UNITS

For the purpose of this specification, the terms, definitions, abbreviations, symbols and units specified in ESA/SCC Basic Specification No. 21300 shall apply.

4. REQUIREMENTS

4.1 GENERAL

The complete requirements for procurement of the connectors specified herein are stated in this specification and ESA/SCC Generic Specification No. 3401. Deviations from the Generic Specification applicable to this specification only, are listed in Para 4.2.

Deviations from the applicable Generic Specification and this Detail Specification, formally agreed with specific Manufacturers on the basis that the alternative requirements are equivalent to the ESA/SCC requirements and do not affect the components' reliability, are listed in the Appendices attached to this specification.

4.2 DEVIATIONS FROM GENERIC SPECIFICATION

4.2.1 Deviations from Special In-process Controls

None.

4.2.2 Deviations from Final Production Tests (Chart II)

- (a) Para. 9.4, Contact Capability: Not applicable.
- (b) Para. 9.5, Magnetism Level: Not applicable.
- (c) Para. 9.8, Installation of Contacts into Insert: Not applicable.
- (d) Para. 9.9, Seal Test: Not applicable.

4.2.3 Deviations from Burn-in and Electrical Measurements (Chart III)

Not applicable.

4.2.4 Deviations from Qualification Tests (Chart IV)

Qualification tests are not applicable.

4.2.5 Deviations from Lot Acceptance Tests (Chart V)

Lot Acceptance tests are not applicable.

4.3 MECHANICAL REQUIREMENTS

4.3.1 Dimension Check

The dimensions of the connector savers specified herein shall be verified in accordance with the requirements set out in Para 9.6 of ESA/SCC Generic Specification No. 3401 and shall conform to those shown in Figure 2 of this specification.

4.3.2 Weight

The maximum weight of the connector savers specified herein, without contacts, shall be as specified in Table 1(a).

4.3.3 Contact Capability

Not applicable.

**4.3.4 Contact Retention (In Insert)**

Not applicable.

4.3.5 Mating and Unmating Forces

The forces applied for mating and unmating of the connectors (axial and torque) shall conform to the values specified in Table 1(a).

4.3.6 Insert Retention (In Shell)

Not applicable.

4.3.7 Jackscrew Retention

Not applicable.

4.3.8 Contact Insertion and Withdrawal Forces

Not applicable.

4.3.9 Engagement and Separation Forces

Not applicable.

4.3.10 Oversize Pin Exclusion

Not applicable.

4.3.11 Probe Damage

Not applicable.

4.3.12 Solderability

Not applicable.

4.4 MATERIALS AND FINISHES

The materials and finishes shall be as specified herein. Where a definite material is not specified, a material which will enable the connectors specified herein to meet the performance requirements of this specification shall be used. Acceptance or approval of any constituent material does not guarantee acceptance of the finished product.

4.4.1 Shell, Coupling Ring and Nuts

The shell and coupling ring shall be made of aluminium alloy, dull low-reflective electroless nickel plated.

4.4.2 Inserts

Bonded sandwich: Silicone/thermosetting or thermoplastic insert/silicone.

4.4.3 Contacts

As specified in the ESA/SCC Detail Specification No. 3401/058.

4.4.4 Contact Retaining Clip

Not applicable.

4.4.5 Guiding and Locking Devices

Not applicable.

4.4.6 Magnetism Level

Not applicable.

4.5 MARKING

4.5.1 General

The marking of all components delivered to this specification shall be in accordance with the requirements of ESA/SCC Basic Specification No. 21700 and the following paragraphs. Each component shall be marked in respect of:-

- (a) Contact Identification.
- (b) The SCC Component Number.
- (c) Characteristics.
- (d) Traceability information.

4.5.2 Contact Identification

Contact identification shall be marked in accordance with Figure 2(b).

4.5.3 The SCC Component Number

The SCC component number shall be constituted and marked as follows:

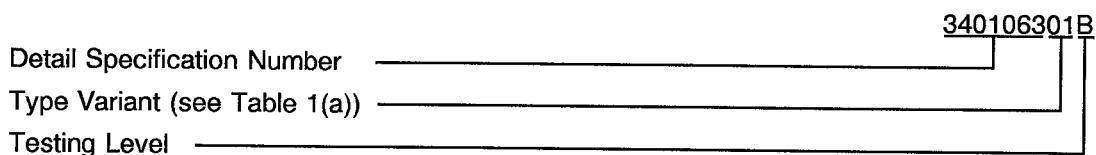

4.5.4 Characteristics

The characteristics to be marked in the following order of precedence are:-

- (a) Grounding. (For Variant 02 only).
- (b) Lock ring.
- (c) Contact arrangement.
- (d) Type of contact (plug side).
- (e) Clocking position.

The information shall be constituted and marked as follows:-

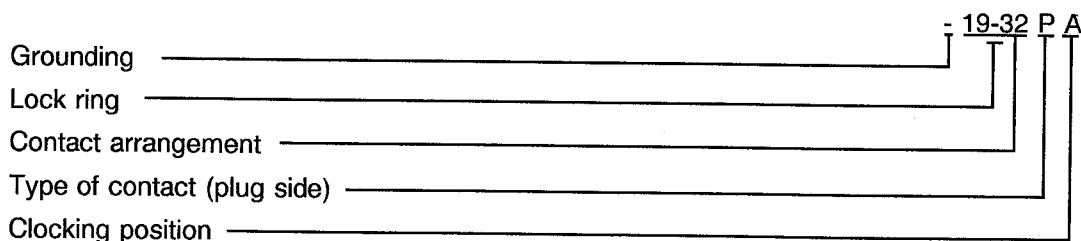

4.5.4.1 Grounding

For Variant 02: Grounding shall be indicated by the letter 'G'. When grounding is not required, the letter 'G' shall be omitted and replaced by a dash (-).

For Variants 01 and 03: Only a dash (-) is applicable.

4.5.4.2 Lock Ring

Lock ring shall be indicated by the letter 'L'. When a lock ring is not required, the letter 'L' shall be omitted and replaced by a dash (-).

4.5.4.3 Contact Arrangements

The number of contacts shall be as shown in Figure 2(b) and contact arrangements shall be indicated by the codes specified hereafter:

TYPE VARIANTS 01 AND 03

CODE	SERVICE RATING	CODE	SERVICE RATING
09-35	M	17-08	II
09-98	I	17-99	I
11-35	M	19-35	M
11-98	I	19-32	I
11-01	II	19-11	II
11-05	I	21-35	M
11-04	I	21-41	I
13-35	M	21-16	II
13-98	I	21-11	II
13-08	I	21-39	I
13-26	M	23-35	M
13-4	I	23-53	I
15-35	M	23-21	II
15-19	I	25-35	M
15-05	I	25-61	I
15-97	I	25-19	I
15-18	I	25-29	I
17-35	M	25-43	I
17-26	I	25-24	I
17-06	I	25-46	N
17-28	I	25-03	I
		25-07	I

TYPE VARIANT 02

CODE	SERVICE RATING	CODE	SERVICE RATING
08-35	M	16-08	II
08-98	I	16-99	I
10-35	M	18-35	M
10-98	I	18-32	I
10-05	I	18-11	II
12-35	M	20-35	M
12-98	I	20-41	I
12-08	I	20-16	II
12-04	I	20-39	I
14-35	M	22-35	M
14-18	I	22-55	I
14-05	II	22-21	II
14-97	I	24-35	M
16-35	M	24-61	I
16-26	I	24-29	I
16-06	I	24-24	I

4.5.4.4 Type of Contact

The contact type shall be indicated by the following code letters:-

CODE LETTER	CONTACT TYPE (PLUG SIDE)
P	Male
S	Female

4.5.4.5 Clocking Position

Clocking positions are as shown in Figure 2(c) and shall be designated by the following code letters: A, B, C, D and E. Code letter N indicates the standard clocking position.

4.5.5 Traceability Information

Traceability information shall be marked in accordance with the requirements of ESA/SCC Basic Specification No. 21700.



4.5.6 Marking of Small Components

Where it is considered that a component is too small to accommodate the marking as specified above, as much as space permits shall be marked. The order of precedence shall be as specified in Para. 4.5.1. The marking information in full shall accompany each component in its primary package.

4.6 ELECTRICAL MEASUREMENTS

4.6.1 Electrical Measurements at Room Temperature

The parameters to be measured in respect of electrical characteristics are scheduled in Table 2. Unless otherwise specified these measurements shall be performed at $T_{amb} = +22 \pm 3$ °C.

4.6.2 Electrical Measurements at High and Low Temperatures (Table 3)

Not applicable.

4.6.3 Circuit for Electrical Measurements (Figure 4)

Not applicable.

4.7 BURN-IN AND ELECTRICAL MEASUREMENTS (TABLES 4 AND 5)

Not applicable.

4.8 ENVIRONMENTAL AND ENDURANCE TESTS (TABLE 6)

Not applicable.

TABLE 2 - ELECTRICAL MEASUREMENTS AT ROOM TEMPERATURE

NO	CHARACTERISTICS	SYMBOL	ESA/SCC No. 3401 TEST METHOD	TEST CONDITION	LIMITS		UNIT
					MIN	MAX	
1	Insulation Resistance	Ri	Para 9.1.1.1	Para 9.1.1.1	10 000	-	MΩ
2	Voltage Proof Leakage Current Service II Service I Service M Service N	I _L	Para 9.1.1.2	2300Vrms 1800Vrms 1300Vrms 1000Vrms	- - - -	2.0 2.0 2.0 2.0	mA
3	Mated Shell Conductivity (1) (Voltage Drop)	Vd	Para. 9.1.1.4	Para. 9.1.1.4	Not applicable		mV

NOTES

1. Applicable to mated connectors with grounding option.

TABLES 3, 4, 5 AND 6

Not applicable.