



europaean space agency  
agence spatiale européenne

Pages 1 to 21



**RELAYS, ELECTROMAGNETIC, LATCHING,**

**28Vdc, 25A, 3PDT,**

**ESA/SCC Detail Specification No. 3602/006**

**SCC**

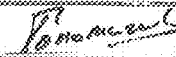
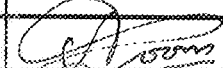
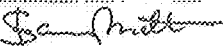
**space components  
coordination group**

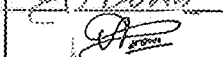
Issue/Rev.	Date	Approved by	
		SCCG Chairman	ESA Director General or his Deputy
Issue 3	October 1995		
Revision 'A'	January 2001		
Revision 'B'	February 2002		

**DOCUMENTATION CHANGE NOTICE**

Rev. Letter	Rev. Date	Reference	CHANGE Item	Approved DCR No.
			This issue supersedes Issue 2 and incorporates all modifications defined in Revisions 'A' and 'B' to Issue 2 and the changes agreed in the following DCRs:- Cover Page DCN	None None
		Para. 1.6	: Deleted in toto	23702
		Para. 1.7	: Renumbered as "1.6" and in text, "4" amended to "3"	23702
		Table 1(a)	: "(Note 1)" added to Variant column heading. Variants 11 to 16 added to comparative existing Variants and entry for Variants 07 to 16 deleted in toto	23702
			: Figure column added	23702
			: Note 1 added	23702
		Table 1(b)	: Nos. 1, 2 and 6, Symbols corrected	23702
			: No. 2, Characteristics corrected	23702
			: Nos. 3 and 4, "Note 1" added to Remarks	221164
			: No. 4, renumbered as "5" and "L/R=20ms" deleted from Remarks	23702
			: No. 5, renumbered as "4" and in Remarks "4.2.4 &" deleted	23702
			: Nos. 7 and 8, Characteristics, Symbol and Max. Rating amended	23702
			: No. 9, in Remarks, details deleted and "Note 2" added	23702
			: Note 1, new Note added	221164
			: Note 2, new Note added	23702
		Figures 2	: Dimension Symbols standardised and missing dimensions added	23702
		Figure 3	: Deleted in toto	23702
		Figure 4	: Renumbered as "3"	23702
		Para. 4.2.3	: Title corrected	23702
		Para. 4.2.4	: Title corrected	23702
			: In deviation for Para. 9.11, "Shock" changed to "Mechanical Shock"	23702
			: In deviation for Para. 9.12, Items (a), (b) and (e) deleted	23702
			: Deviation for Para. 9.16 deleted in toto	23702
			: Deviation for Para. 9.19.2 amended	23702
		Para. 4.2.5	: Existing text deleted and deviations added	23702
		Para. 4.3.3	: Duration added	221319
		Para. 4.4.2	: Title and text amended	21025
		Para. 4.5.1	: Existing text deleted and new text added	23702
		Para. 4.5.2	: In text, "4" amended to "3"	23702
		Para. 4.5.4	: In Table, "Coil Resistance" added	23702
		Para. 4.6.1	: Second sentence completed	23702
		Table 2	: 4th column heading amended and applicable paragraph numbers added	23702
			: Nos. 5 and 6, Symbols amended	23702
			: No. 7, Note reference moved to 5th column	23702
		Table 3	: No. 8, "Contact" added to Characteristics	23702
			: 4th column heading amended and applicable paragraph numbers added	23702
			: No. 6, Note reference moved from Characteristics to 5th column and Symbol corrected	23702



**DOCUMENTATION CHANGE NOTICE**

Rev. Letter	Rev. Date	Reference	CHANGE Item	Approved DCR No.
		Figure 4 Table 4  Table 5(b) Figure 5(a) Figure 5(b) Para. 4.8 Para's 4.8.1 to 4.8.3 Para. 4.8.5 Table 6	: Entry added : 4th column heading amended and applicable paragraph numbers added : Item 3 deleted in toto : Entry added : Entry added : Title expanded : Texts amended : Entry added : Table reformatted	23702 23702  23702 23702 23702 23702 23702 23702 23702
'A'	Jan. '01	P1. Cover page P2A. DCN P6. Table 1(b)	: No. 1, Symbol amended : No. 2, Characteristics, Symbol and Maximum Ratings amended : New Note 3 added	None None 221599 221599 221599
'B'	Feb. '02	P1. Cover page P2A. DCN P16. Table 2  P17. Table 3	: No. 1, Values added to "Limits Min." column. : No. 2, Values added to "Limits Min." column. : No. 1, Values added to "Limits Min." column. : No. 2, Values added to "Limits Min." column. : New Note 2 added.	None None 221617 221617 221617 221617 221617

**SCC**

ESA/SCC Detail Specification

No. 3602/006

PAGE 3

ISSUE 3

**TABLE OF CONTENTS**

	<u>Page</u>
<b>1. <u>GENERAL</u></b>	<b>5</b>
1.1 Scope	5
1.2 Component Type Variants	5
1.3 Maximum Ratings	5
1.4 Parameter Derating Information	5
1.5 Physical Dimensions	5
1.6 Circuit Schematic	5
<b>2. <u>APPLICABLE DOCUMENTS</u></b>	<b>5</b>
<b>3. <u>TERMS, DEFINITIONS, ABBREVIATIONS, SYMBOLS AND UNITS</u></b>	<b>5</b>
<b>4. <u>REQUIREMENTS</u></b>	<b>13</b>
4.1 General	13
4.2 Deviations from Generic Specification	13
4.2.1 Deviations from Special In-Process Controls	13
4.2.2 Deviations from Final Production Tests	13
4.2.3 Deviations from Screening Tests	13
4.2.4 Deviations from Qualification Tests	13
4.2.5 Deviations from Lot Acceptance Tests	13
4.3 Mechanical Requirements	14
4.3.1 Dimension Check	14
4.3.2 Weight	14
4.3.3 Terminal Strength	14
4.4 Materials and Finishes	14
4.4.1 Case	14
4.4.2 Terminal Material and Finish	14
4.5 Marking	14
4.5.1 General	14
4.5.2 Terminal Identification	14
4.5.3 The SCC Component Number	15
4.5.4 Electrical Characteristics	15
4.5.5 Traceability Information	15
4.6 Electrical Measurements	15
4.6.1 Electrical Measurements at Room Temperature	15
4.6.2 Electrical Measurements at High and Low Temperatures	15
4.6.3 Circuits for Electrical Measurements	15
4.7 Screening	15
4.7.1 Miss Test	15
4.7.2 Conditions for Screening	15
4.7.3 Electrical Circuits for Screening	15
4.8 Environmental and Endurance Testing	19
4.8.1 Measurements and Inspections on Completion of Environmental Tests	19
4.8.2 Measurements and Inspections during Endurance Tests	19
4.8.3 Measurements and Inspections on Completion of Endurance Tests	19
4.8.4 Conditions for Operating Life Tests	19
4.8.5 Electrical Circuits for Operating Life Tests	19

**TABLES**Page

1(a)	Type Variants	6
1(b)	Maximum Ratings	6
2	Electrical Measurements at Room Temperature	16
3	Electrical Measurements at High and Low Temperatures	17
4	Measurements during Screening	18
5(a)	Conditions for Screening	18
5(b)	Conditions for Operating Life Test	18
6	Measurements and Inspection on Completion of Environmental Tests and at Intermediate Points and on Completion of Endurance Testing	20

**FIGURES**

1	Not applicable	
2	Physical Dimensions	7
3	Circuit Schematic	12
4	Circuits for Electrical Measurements	18
5(a)	Electrical Circuits for Screening	18
5(b)	Electrical Circuits for Operating Life Test	18

**APPENDICES (Applicable to specific Manufacturers only)**

None.

**1. GENERAL****1.1 SCOPE**

This specification details the ratings, physical and electrical characteristics, test and inspection data for a Relay, Electromagnetic, Latching, 28Vdc, 25A, 3PDT.

It shall be read in conjunction with ESA/SCC Generic Specification No. 3602, the requirements of which are supplemented herein.

**1.2 COMPONENT TYPE VARIANTS**

Variants of the basic type relays specified herein, which are also covered by this specification, are given in Table 1(a).

**1.3 MAXIMUM RATINGS**

The maximum ratings, which shall not be exceeded at any time during use or storage, applicable to the relays specified herein, are scheduled in Table 1(b).

**1.4 PARAMETER DERATING INFORMATION (FIGURE 1)**

Not applicable.

**1.5 PHYSICAL DIMENSIONS**

The physical dimensions of the relays specified herein are shown in Figure 2.

**1.6 CIRCUIT SCHEMATIC**

The circuit schematic, showing terminal identification etc. for the relays specified herein, is shown in Figure 3.

**2. APPLICABLE DOCUMENTS**

The following documents form part of this specification and shall be read in conjunction with it:-

- (a) ESA/SCC Generic Specification No. 3602 for Relays, Electromagnetic, Latching.
- (b) MIL-STD-202, Test Methods for Electronic and Electrical Component Parts.

**3. TERMS, DEFINITIONS, ABBREVIATIONS, SYMBOLS AND UNITS**

For the purpose of this specification, the terms, definitions, abbreviations, symbols and units specified in ESA/SCC Basic Specification No. 21300 shall apply.

**TABLE 1(a) - TYPE VARIANTS**

VARIANT (NOTE 1)	DESCRIPTION	FIGURE
01, 11	Not to be used	-
02, 12	Hook terminals and horizontal flange mount	2(a)
03, 13	Straight terminals and horizontal flange mount	2(b)
04, 14	Hook terminals and vertical flange mount	2(c)
05, 15	Straight terminals and plain case	2(d)
06, 16	Hook terminals and plain case	2(e)

**NOTES**

- Variant differences are Coil Resistance (see Table 2, Item 9).

**TABLE 1(b) - MAXIMUM RATINGS**

No.	CHARACTERISTICS	SYMBOL	MAXIMUM RATING	UNIT	REMARKS
1	Rated Coil Voltage:- 28V 12V 6V	$V_{CR}$	28 12 6.0	Vdc	Note 3
2	Coil Voltage Range:- 28V 12V 6V	$V_{CR}$	26.5 to 32 11 to 14.5 5.5 to 7.3	Vdc	
3	Rated Contact Current Resistive Load	$I_{CR}$	25	A	28Vdc resistive Note 1
4	Overload Current Resistive	$I_{overL}$	50	A	28Vdc resistive See Table 6
5	Rated Contact Current Inductive Load	$I_{CL}$	12	A	28Vdc inductive Note 1
6	Contact Resistance	$R_C$	6.0	m $\Omega$	At rated current
7	High Temperature	$T_{amb}$	+ 125	$^{\circ}C$	
8	Low Temperature	$T_{amb}$	- 65	$^{\circ}C$	
9	Soldering Temperature	$T_{sol}$	+ 260	$^{\circ}C$	Note 2

**NOTES**

- Relays should not be used in change over-mode where the potential difference between stationary contacts is greater than 10V and the switched current is greater than 0.1A.
- Duration 10 seconds maximum at a distance of not less than 3.0mm from the device body and the same terminal shall not be resoldered until 3 minutes have elapsed.
- The Coil Voltage rise time shall be less than  $0.1t_L$  or  $t_r$ . The coil voltage shall be applied for a minimum time of  $10t_L$  or  $10t_r$ .



**FIGURE 2 - PHYSICAL DIMENSIONS**

**FIGURE 2(a) - VARIANTS 02 AND 12, RELAY WITH WITH HOOK TERMINALS AND HORIZONTAL FLANGE MOUNT**

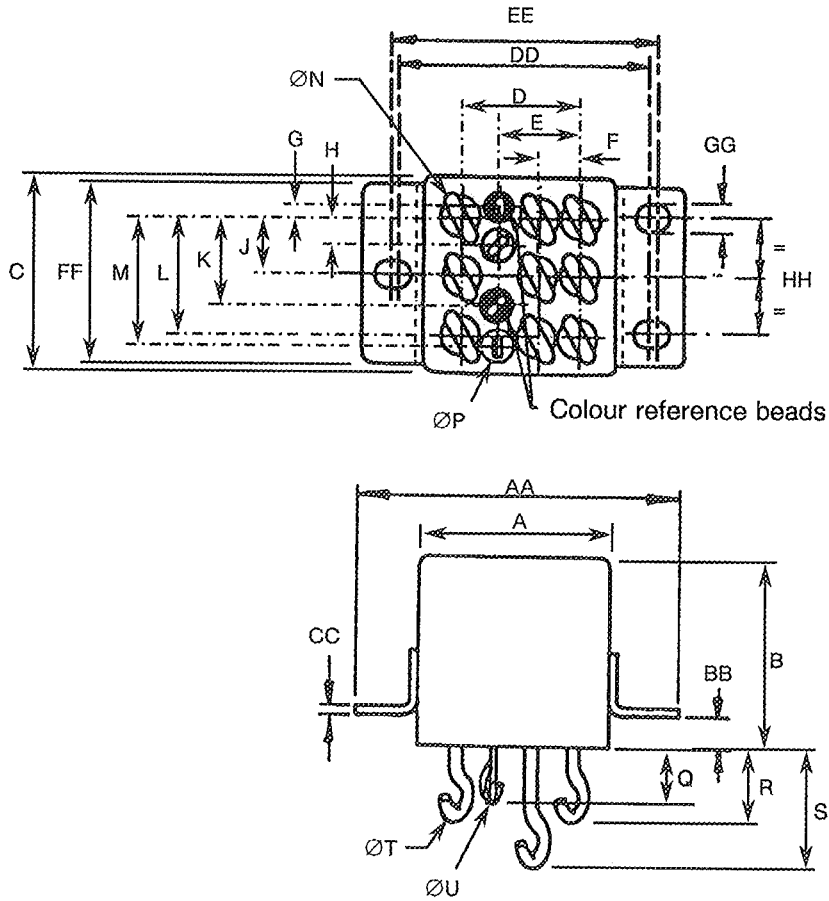

SYMBOL	MILLIMETRES	
	MIN.	MAX.
AA	-	43.60
BB	3.80	4.20
CC	0.90	1.10
DD	35.20	35.70
EE	36.45	36.95
FF	23.60	24.00
GG	3.55	4.05
HH	15.65	16.15
A	-	26.00
B	-	25.70
C	-	26.00
D	15.80	16.20
E	10.80	11.20
F	5.80	6.00

SYMBOL	MILLIMETRES	
	MIN.	MAX.
G	1.15	1.35
H	3.70	3.90
J	7.50	7.70
K	11.20	11.60
L	15.00	15.40
M	16.40	16.60
ØN	2.30	2.45
ØP	0.95	1.10
Q	7.10	8.10
R	9.00	10.00
S	15.40	16.40
ØT	2.30	2.45
ØU	0.95	1.10





**FIGURE 2 - PHYSICAL DIMENSIONS (CONTINUED)**

**FIGURE 2(b) - VARIANTS 03 AND 13, RELAY WITH STRAIGHT TERMINALS AND HORIZONTAL FLANGE MOUNT**

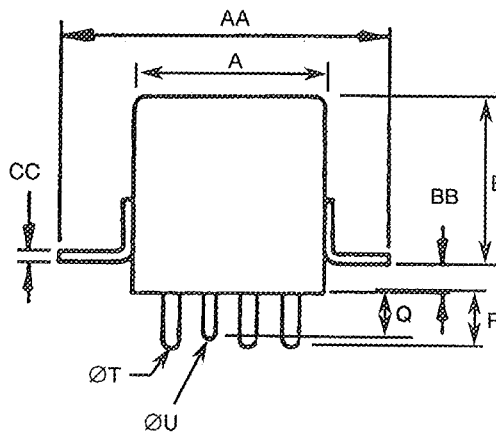
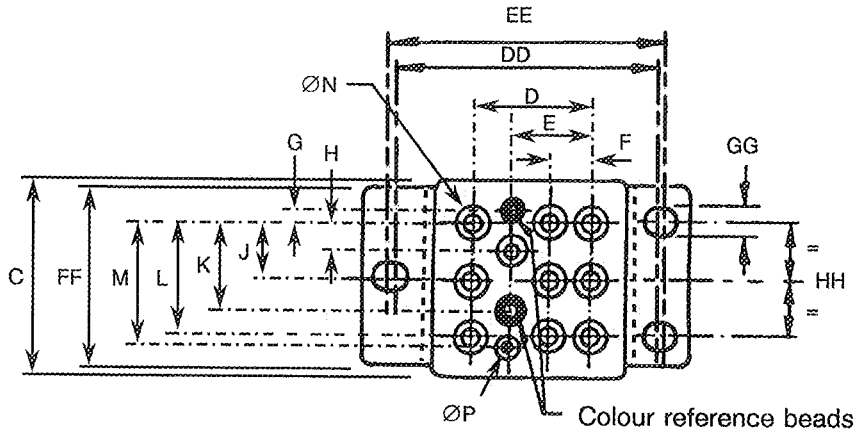

SYMBOL	MILLIMETRES	
	MIN.	MAX.
AA	-	43.60
BB	3.80	4.20
CC	0.90	1.10
DD	35.20	35.70
EE	36.45	36.95
FF	23.60	24.00
GG	3.55	4.05
HH	15.65	16.15
A	-	26.00
B	-	25.70
C	-	26.00
D	15.80	16.20
E	10.80	11.20

SYMBOL	MILLIMETRES	
	MIN.	MAX.
F	5.70	6.20
G	1.15	1.30
H	3.70	3.90
J	7.50	7.70
K	11.20	11.60
L	15.00	15.40
M	16.40	16.60
ØN	2.30	2.41
ØP	0.99	1.05
Q	6.10	6.60
R	6.60	7.10
ØS	1.55	1.61



**FIGURE 2 - PHYSICAL DIMENSIONS (CONTINUED)**

**FIGURE 2(c) - VARIANTS 04 AND 14, RELAY WITH HOOK TERMINALS AND VERTICAL FLANGE MOUNT**

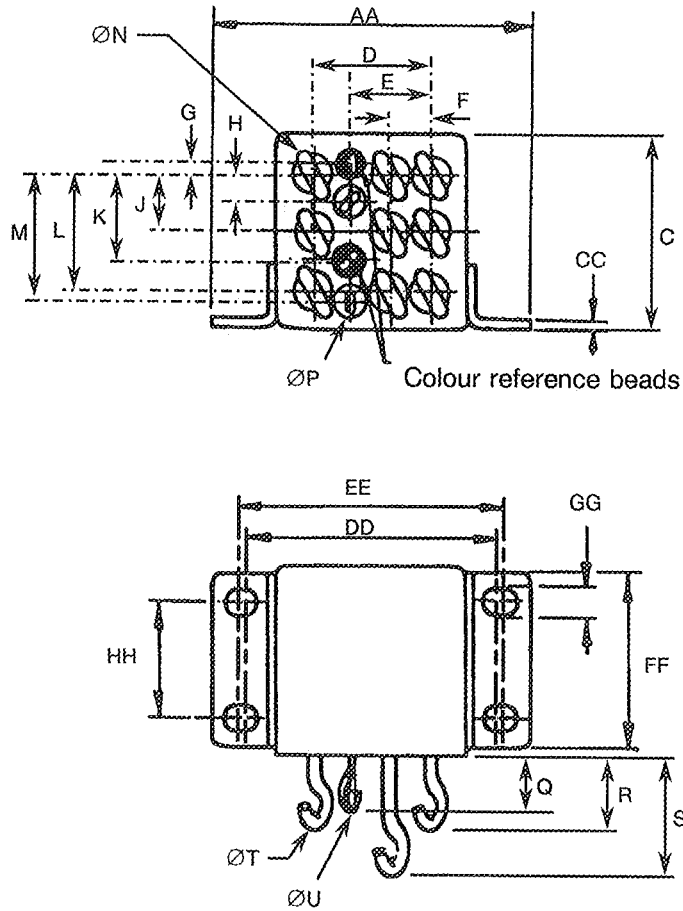

SYMBOL	MILLIMETRES	
	MIN.	MAX.
AA	-	43.60
BB	-	-
CC	0.90	1.10
DD	35.20	35.70
EE	36.45	36.95
FF	23.60	24.00
GG	3.55	4.05
HH	15.65	16.15
A	-	26.00
B	-	25.70
C	-	26.00
D	15.80	16.20
E	10.80	11.20
F	5.80	6.00

SYMBOL	MILLIMETRES	
	MIN.	MAX.
G	1.15	1.35
H	3.70	3.90
J	7.50	7.70
K	11.20	11.60
L	15.00	15.40
M	16.40	16.60
ØN	2.30	2.45
ØP	0.95	1.10
Q	7.10	8.10
R	9.00	10.00
S	15.40	16.40
ØT	2.30	2.45
ØU	0.95	1.10



**FIGURE 2 - PHYSICAL DIMENSIONS (CONTINUED)**

**FIGURE 2(d) - VARIANTS 05 AND 15, RELAY WITH STRAIGHT TERMINALS AND PLAIN CASE**

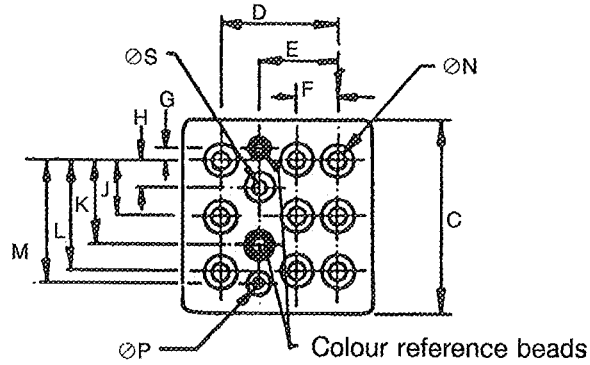

SYMBOL	MILLIMETRES	
	MIN.	MAX.
A	-	26.00
B	-	25.70
C	-	26.00
D	15.80	16.20
E	10.80	11.20
F	5.70	6.20
G	1.15	1.30
H	3.70	3.90
J	7.50	7.70
K	11.20	11.60
L	15.00	15.40
M	16.40	16.60
ØN	2.30	2.41
ØP	0.99	1.05
Q	6.10	6.60
R	6.60	7.10
ØS	1.55	1.61



**FIGURE 2 - PHYSICAL DIMENSIONS (CONTINUED)**

**FIGURE 2(e) - VARIANTS 06 AND 16, RELAY WITH HOOK TERMINALS AND PLAIN CASE**

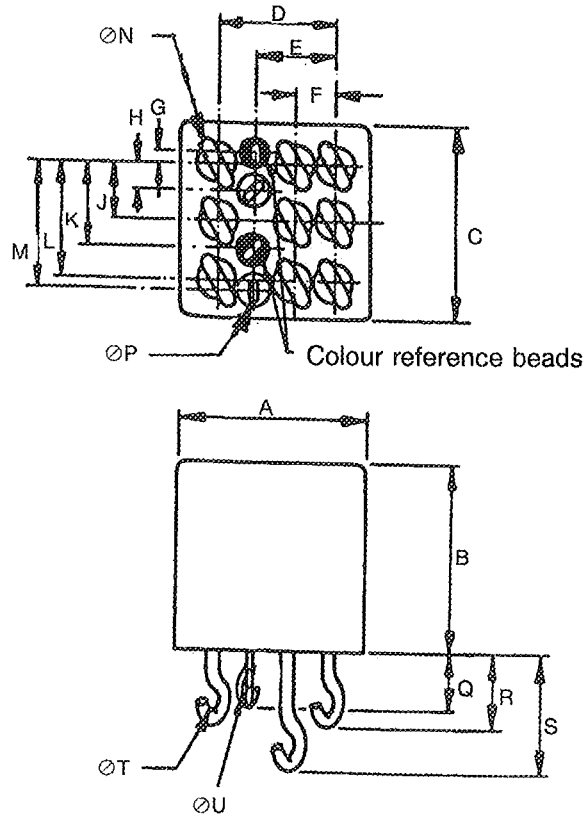

SYMBOL	MILLIMETRES	
	MIN.	MAX.
A	-	26.00
B	-	25.70
C	-	26.00
D	15.80	16.20
E	10.80	11.20
F	5.80	6.00
G	1.15	1.35
H	3.70	3.90
J	7.50	7.70
K	11.20	11.60
L	15.00	15.40
M	16.40	16.60
ØN	2.30	2.45
ØP	0.95	1.10
Q	7.10	8.10
R	9.00	10.00
S	15.40	16.40
ØT	2.30	2.45
ØU	0.95	1.10



**FIGURE 3 - CIRCUIT SCHEMATIC**

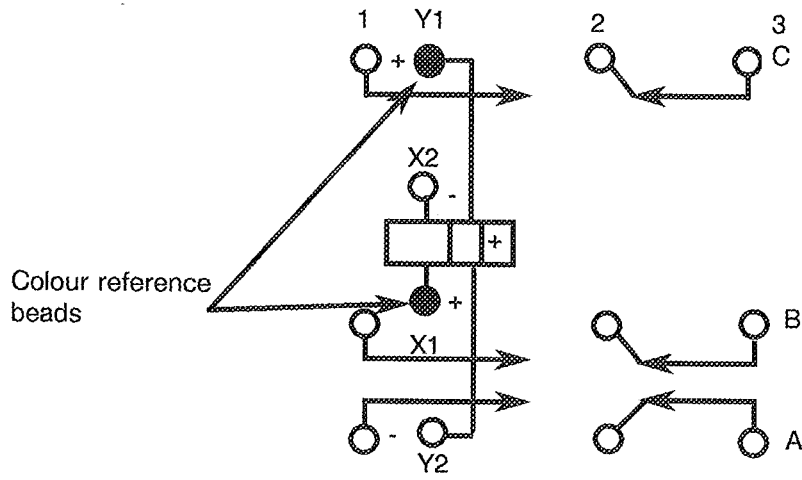

Y - last coil energised

As viewed from terminal side

**NOTES**

1. Numbers appear for reference purposes only.



#### 4. REQUIREMENTS

##### 4.1 GENERAL

The complete requirements for procurement of the relays specified herein are stated in this specification and ESA/SCC Generic Specification No. 3602 for Relays, Electromagnetic Latching. Deviations from the Generic Specification, applicable to this specification only, are listed in Para. 4.2.

Deviations from the applicable Generic Specification and this Detail Specification, formally agreed with specific Manufacturers on the basis that the alternative requirements are equivalent to the ESA/SCC requirements and do not affect the components' reliability, are listed in the appendices attached to this specification.

##### 4.2 DEVIATIONS FROM GENERIC SPECIFICATION

###### 4.2.1 Deviations from Special In-process Controls

None.

###### 4.2.2 Deviations from Final Production Tests (Chart II)

None

###### 4.2.3 Deviations from Screening Tests (Chart III)

(a) Para 9.6, Vibration Scan : Frequency Range: 10 - 3000Hz.

###### 4.2.4 Deviations from Qualification Tests (Chart IV)

(a) Para 9.10, Vibration: Frequency Range: 10 - 3000 Hz.

(b) Para 9.11, Mechanical Shock: Test Condition: 200g, 6.0ms, 1/2 sine wave.

(c) Para 9.12, Overload: Separate tests shall be performed for N/O and N/C contacts.  
Overload current shall be 50A resistive.

(d) Para 9.19.1, Resistive Load: Number of operations: 50000.

(e) Para 9.19.3, Inductive Load: Number of operations: 10000.

###### 4.2.5 Deviations from Lot Acceptance Tests (Chart V)

(a) Para 9.10, Vibration: Frequency Range: 10 - 3000 Hz.

(b) Para 9.11, Mechanical Shock: Test Condition: 200g, 6.0ms, 1/2 sine wave.

(c) Para 9.12, Overload: Separate tests shall be performed for N/O and N/C contacts.  
Overload current shall be 50A resistive.

(d) Para 9.19.1, Resistive Load: Number of operations: 50000.

(e) Para 9.19.3, Inductive Load: Number of operations: 10000.

(f) Para. 9.16, Intermediate Current: The number of operations shall be 5000.



#### 4.3 MECHANICAL REQUIREMENTS

##### 4.3.1 Dimension Check

The dimensions of the relays specified herein shall be verified in accordance with the requirements set out in Para 9.5 of ESA/SCC Generic Specification No. 3602 and shall conform to those shown in Figure 2.

##### 4.3.2 Weight

The maximum weight of the relays specified herein shall be 82 grammes.

##### 4.3.3 Terminal Strength

The requirements for terminal strength testing are specified in Section 9 of ESA/SCC Generic Specification No. 3602. The test conditions shall be as follows:-

###### **Pull Test**

Applied Force: 50 Newtons minimum for terminal diameter greater than 1.2mm.  
25 Newtons minimum for terminal diameter equal to or smaller than 1.2mm.

Duration: 5 seconds minimum

Para's 9.17.2 and 9.17.3 are not applicable.

#### 4.4 MATERIALS AND FINISHES

The materials and finishes shall be as specified herein. Where a definite material is not specified, a material which will enable the relays specified herein to meet the performance requirements of this specification shall be used. Acceptance or approval of any constituent material does not guarantee acceptance of the finished product.

##### 4.4.1 Case

Copper nickel, welded construction. Neither electro-deposited tin nor any paint shall be used.

##### 4.4.2 Terminal Material and Finish

The terminal material shall be Type 'H' with Type '3 or 4' finish in accordance with the requirements of ESA/SCC Basic Specification No. 23500.

#### 4.5 MARKING

##### 4.5.1 General

The marking of all components delivered to this specification shall be in accordance with the requirements of ESA/SCC Basic Specification No. 21700 and the following paragraphs. When the component is too small to accommodate all of the marking specified, as much as space permits shall be marked and the marking information, in full, shall accompany the component in its primary package.

The information to be marked and the order of precedence, shall be as follows:-

- (a) Terminal Identification.
- (b) The SCC Component Number.
- (c) Electrical Characteristics.
- (d) Traceability Information.

##### 4.5.2 Terminal Identification

Terminal identification shall be marked on the relay can in accordance with Figure 3.



4.5.3 The SCC Component Number

Each component shall bear the SCC Component Number which shall be constituted and marked as follows:

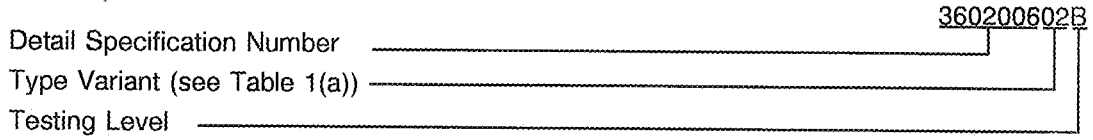

4.5.4 Electrical Characteristics

The electrical characteristic to be marked is the rated coil voltage. The information shall be constituted and marked as follows:-

Coil Voltage	Coil Resistance		Code
	Variants 02 to 06	Variants 12 to 16	
28Vdc	450Ω	300Ω	28V
12Vdc	111.5Ω	60Ω	12V
6.0Vdc	28Ω	15Ω	6V

4.5.5 Traceability Information

Each component shall be marked in respect of traceability information in accordance with the requirements of ESA/SCC Basic Specification No. 21700.

4.6 ELECTRICAL MEASUREMENTS

4.6.1 Electrical Measurements at Room Temperature

The parameters to be measured at room temperature are scheduled in Table 2. Unless otherwise specified, the measurements shall be performed at  $T_{amb} = +22 \pm 3 \text{ }^\circ\text{C}$ .

4.6.2 Electrical Measurements at High and Low Temperatures

The parameters to be measured at high and low temperatures are scheduled in Table 3.

4.6.3 Circuits for Electrical Measurements (Figure 4)

Not applicable.

4.7 SCREENING

4.7.1 Miss Test

During the miss test, the contact resistance shall be continuously monitored and not exceed the values specified in Table 4 of this specification.

4.7.2 Conditions for Screening

The requirements for screening are specified in Section 7 of ESA/SCC Generic Specification No. 3602. The conditions for screening shall be as specified in Table 5(a) of this specification.

4.7.3 Electrical Circuits for Screening (Figure 5(a))

Not applicable.



**SEC**ESA/SCC Detail Specification  
No. 3602/006

Rev. 'B'

PAGE 16

ISSUE 3

**TABLE 2 - ELECTRICAL MEASUREMENTS AT ROOM TEMPERATURE**

No.	CHARACTERISTICS	SYMBOL	ESA/SCC 3602 TEST METHOD	TEST CONDITION	LIMITS		UNIT
					MIN.	MAX.	
1	Latch Voltage:- 28V 12V 6V	$U_L$	Para. 9.3.1	Para. 9.3.1	9.1 3.6 1.8	14 6.6 3.3	V
2	Reset Voltage:- 28V 12V 6V	$U_R$	Para. 9.3.2	Para. 9.3.2	9.1 3.6 1.8	14 6.6 3.3	V
3	Latch Time	$t_L$	Para. 9.3.4	Para. 9.3.4	-	15	ms
4	Reset Time	$t_r$	Para. 9.3.4	Para. 9.3.4	-	15	ms
5	Bounce Time	$t_b$	Para. 9.3.4	Para. 9.3.4	-	1.0	ms
6	Insulation Resistance	$R_i$	Para. 9.3.7	Para. 9.3.7 at 500Vdc	100	-	M $\Omega$
7	Voltage Proof	VP	Para. 9.3.6	Para. 9.3.6 Note 1	1250	-	Vrms
8	Contact Voltage Drop	$V_d$	Para. 9.3.3	Para. 9.3.3 25A, 6.0Vdc	-	150	mV
9	Coil Resistance Latch and Reset Variants 02 to 06: 28V 12V 6V Variants 12 to 16: 28V 12V 6V	$R_B$	Para. 9.3.5	Para. 9.3.5	405 100 25 270 54 13.5	495 123 31 330 66 16.5	$\Omega$

**NOTES**

1. 1000V between coil and case, between open contacts; 500V between coils.

**TABLE 3 - ELECTRICAL MEASUREMENTS AT HIGH AND LOW TEMPERATURES**

No.	CHARACTERISTICS	SYMBOL	ESA/SCC 3602 TEST METHOD	TEST CONDITION	LIMITS		UNIT
					MIN.	MAX.	
1	Latch Voltage:- 28V 12V 6V	$U_L$	Para. 9.3.1	Para. 9.3.1	6.3 2.5 1.3	19.8 9.0 4.5	V
2	Reset Voltage:- 28V 12V 6V	$U_R$	Para. 9.3.2	Para. 9.3.2	6.3 2.5 1.3	19.8 9.0 4.5	V
3	Latch Time	$t_L$	Para. 9.3.4	Para. 9.3.4	-	15	ms
4	Reset Time	$t_r$	Para. 9.3.4	Para. 9.3.4	-	15	ms
5	Bounce Time	$t_b$	Para. 9.3.4	Para. 9.3.4	-	1.0	ms
6	Insulation Resistance	$R_i$	Para. 9.3.7	Para. 9.3.7 at 500Vdc Note 1	50	-	M $\Omega$

**NOTES**

1. This measurement shall be made only at the high temperature condition.
2. Limits Min. apply to measurements at -55°C and Limits Max. to +125°C.

**FIGURE 4 - CIRCUITS FOR ELECTRICAL MEASUREMENTS**

Not applicable.

**TABLE 4 - MEASUREMENTS DURING SCREENING**

No.	CHARACTERISTICS	SYMBOL	ESA/SCC 3602 TEST METHOD	TEST CONDITIONS	MAXIMUM LIMIT	UNIT
10	Miss Test, Contact Resistance	$R_C$	Para. 9.8	Para. 9.8	100	$\Omega$

**TABLE 5(a) - CONDITIONS FOR SCREENING**

No.	CHARACTERISTICS	SYMBOL	CONDITION	UNIT
1	Ambient High Temperature	$T_{amb}$	+125(+0-3)	$^{\circ}\text{C}$
2	Ambient Low Temperature	$T_{amb}$	-65(+3-0)	$^{\circ}\text{C}$
3	Ambient Room Temperature	$T_{amb}$	+22 $\pm$ 3	$^{\circ}\text{C}$

**TABLE 5(b) - CONDITIONS FOR OPERATING LIFE TEST**

No.	CHARACTERISTICS	SYMBOL	CONDITION	UNIT
1	Ambient Temperature	$T_{amb}$	+125(+0-3)	$^{\circ}\text{C}$
2	Contact Load Resistive	V I	28 25	Vdc Adc

**FIGURE 5(a) - ELECTRICAL CIRCUITS FOR SCREENING**

Not applicable.

**FIGURE 5(b) - ELECTRICAL CIRCUITS FOR OPERATING LIFE TEST**

Not applicable.



- 4.8 ENVIRONMENTAL AND ENDURANCE TESTS (CHARTS IV AND V OF ESA/SCC GENERIC SPECIFICATION No. 3602)
- 4.8.1 Measurements and Inspections on Completion of Environmental Tests  
The parameters to be measured and inspections to be performed on completion of environmental tests are scheduled in Table 6. Unless otherwise stated, the measurements shall be performed at  $T_{amb} = +22 \pm 3 \text{ }^\circ\text{C}$ .
- 4.8.2 Measurements and Inspections during Endurance Tests  
The parameters to be measured and inspections to be performed during endurance tests are scheduled in Table 6. Unless otherwise stated, the measurements shall be performed at  $T_{amb} = +22 \pm 3 \text{ }^\circ\text{C}$ .
- 4.8.3 Measurements and Inspections on Completion of Endurance Tests  
The parameters to be measured and inspections to be performed on completion of endurance tests are scheduled in Table 6. Unless otherwise stated, the measurements shall be performed at  $T_{amb} = +22 \pm 3 \text{ }^\circ\text{C}$ .
- 4.8.4 Conditions for Operating Life Tests (Part of Endurance Testing)  
The requirements for operating life testing are specified in Section 9 of ESA/SCC Generic Specification No. 3602. The conditions for operating life testing shall be as specified in Table 5(b) of this specification.
- 4.8.5 Electrical Circuits for Operating Life Tests (Figure 5(b))  
Not applicable.



**TABLE 6 - MEASUREMENTS AND INSPECTIONS ON COMPLETION OF ENVIRONMENTAL TESTS AND AT INTERMEDIATE POINTS AND ON COMPLETION OF ENDURANCE TESTING**

No.	ESA/SCC GENERIC SPEC. NO. 3602		MEASUREMENTS AND INSPECTIONS		SYMBOL	LIMITS		UNIT
	ENVIRONMENTAL AND ENDURANCE TESTS (1)	TEST METHOD AND CONDITIONS	IDENTIFICATION	CONDITIONS		MIN.	MAX.	
01	Vibration	Para. 9.10 and Para. 4.2.4 of this spec.	<b>Measurements during Test</b> Contact Monitoring  <b>Final Measurements</b> Visual Examination	ESA/SCC 3602 Para. 9.10  -	-  -	-  -	-  -	-  -
02	Mechanical Shock	Para. 9.11 and Para. 4.2.4 of this spec.	<b>Measurements during Test</b> Contact Monitoring  <b>Final Measurements</b> Electrical Measurements Visual Examination	ESA/SCC 3602 Para. 9.11  Table 2 Items 7-8-1-2 -	-  -	-  Table 2 -	-  -	-  -
03	Overload	Para. 9.12 and Table 1(b) Item 4 and Para. 4.2.4 of this spec.	<b>Measurements during Test</b> Contact Voltage Drop  <b>Final Measurements</b> Fuse Continuity Contact Voltage Drop (2) Insulation Resistance Voltage Proof (all Points) (3) Electrical Measurements	ESA/SCC 3602 Para. 9.12.3  - Table 2 Item 8 Table 2 Item 6 Table 2 Item 7 Table 2 Items 1-2-3-4-5-9	V <sub>d</sub>  - V <sub>d</sub> R <sub>i</sub> VP	Para. 9.12.3  Continuity - 175 50 - 1000 - Table 2	mV  mV MΩ Vrms	
04	Thermal Shock	Para. 9.13	<b>During 5th Cycle</b>  Electrical Measurements at +125°C Electrical Measurements at -65°C <b>Final Measurements</b> Visual Examination Voltage Proof (all Points) (3)	In Conditioning Chamber Table 3 Items 1-2-3-4-6 Table 3 Items 1-2-3-4  - Table 2 Item 7	-  - VP	Table 3  Table 3  - Table 2	-  -	-  Vrms
05	Salt Spray	Para. 9.14	<b>Final Measurements</b> Visual Examination Electrical Measurements  Voltage Proof (all Points) (3)	-  Table 2 Items 1-2-3-4-5-6-8-9 Table 2 Item 7	-  - VP	-  Table 2  1000 -	-  -	-  Vrms
06	Intermediate Current	Para. 9.16	<b>Measurements during Test</b> Contact Voltage Drop  <b>Final Measurements</b> Insulation Resistance Voltage Proof (all Points) (3) Electrical Measurements  Contact Voltage Drop (2)	ESA/SCC 3602 Para. 9.16.3  Table 2 Item 6 Table 2 Item 7 Table 2 Items 1-2-3-4-5-9 ESA/SCC 3602 Para. 9.16.3	V <sub>d</sub>  R <sub>i</sub> VP  V <sub>d</sub>	Para. 9.16.3  50 1000 - Table 2  Para. 9.16.3	mV  MΩ Vrms  mV	
07	Terminal Strength	Para. 9.17 and Para. 4.3.3 of this spec.	Visual Examination	ESA/SCC 3602 Para. 9.17.3	-	-	-	-

**NOTES**

1. The tests in this table refer to either Chart IV or V and shall be used as applicable.
2. Reading time 5 to 10 seconds, if required.
3. 500Vrms between coils.



**TABLE 6 - MEASUREMENTS AND INSPECTIONS ON COMPLETION OF ENVIRONMENTAL TESTS AND AT INTERMEDIATE POINTS AND ON COMPLETION OF ENDURANCE TESTING (CONT'D)**

No.	ESA/SCC GENERIC SPEC. NO. 3602		MEASUREMENTS AND INSPECTIONS		SYMBOL	LIMITS		UNIT
	ENVIRONMENTAL AND ENDURANCE TESTS (1)	TEST METHOD AND CONDITIONS	IDENTIFICATION	CONDITIONS		MIN.	MAX.	
08	Resistance to Soldering Heat	Para 9.18	Electrical Measurements	Table 2 Items 1-2-6-8-9		Table 2		
09	Operating Life Resistive	Para's 9.19, 9.19.1 and Table 5(b) of this spec.	<b>Measurements during Test</b> Contact Voltage Drop  <b>Final Measurements</b> Fuse Continuity Contact Voltage Drop (2) Insulation Resistance Voltage Proof (all Points) (3) Electrical Measurements	ESA/SCC 3602 Para. 9.19.1  - Table 2 Item 8 Table 2 Item 6 Table 2 Item 7 Table 2 Items 1-2-3-4-5-9	V <sub>d</sub>  - V <sub>d</sub> R <sub>i</sub> VP	Para. 9.19.1  Continuity - 175 50 1000 Table 2	mV  mV MΩ Vrms	
10	Inductive Life	Para. 9.19.3 and Table 1(b) Item 5 of this spec.	<b>Measurements during Test</b> Contact Voltage Drop  <b>Final Measurements</b> Fuse Continuity Contact Voltage Drop (2) Insulation Resistance Voltage Proof (all Points) (3) Electrical Measurements	ESA/SCC 3602 Para. 9.19.1  - Table 2 Item 8 Table 2 Item 6 Table 2 Item 7 Table 2 Items 1-2-3-4-5-9	V <sub>d</sub>  - V <sub>d</sub> R <sub>i</sub> VP	Para. 9.19.1  Continuity - 175 50 1000 Table 2	mV  mV MΩ Vrms	
11	Mechanical Life	Para. 9.19.4	<b>Final Measurements</b> Contact Voltage Drop Electrical Measurements	Table 2 Item 8 Table 2 Items 1-2-3-4-5-9		- Table 2	175 mV	

**NOTES**

1. The tests in this table refer to either Chart IV or V and shall be used as applicable.
2. Reading time 5 to 10 seconds, if required.
3. 500Vrms between coils.