



europaean space agency
agence spatiale européenne

Pages 1 to 24

RELAYS, ELECTROMAGNETIC, LATCHING
50Vdc, 2A, 2PDT, HALF-SIZE CRYSTAL CAN,
BASED ON TYPE GP250
ESA/SCC Detail Specification No. 3602/010



**space components
coordination group**

Issue/Rev.	Date	Approved by	
		SCCG Chairman	ESA Director General or his Deputy
Issue 3	October 1995		
Revision 'A'	October 1997		
Revision 'B'	June 2000		
Revision 'C'	January 2001		

**DOCUMENTATION CHANGE NOTICE**

Rev. Letter	Rev. Date	Reference	CHANGE Item	Approved DCR No.
		This Issue supersedes Issue 2 and incorporates the changes agreed in the following DCRs:-		
		Cover Page		None
		DCN		None
		Para. 1.6	: Deleted in toto	23702
		Para. 1.7	: Renumbered as "1.6" and in text, "4" amended to "3"	23702
		Table 1(b)	: No. 3, "Note 1" added to Remarks column	221164
			: Nos. 5 and 6, new Nos. 5 and 6 added, and existing tests renumbered as "7" and "8" respectively	221319
			: No. 9, new No. 9 added	221319
			: Note 1, new Note added	221164
			: Note 2, new Note added	23702
		Figures 2	: Dimension Symbols standardised	23702
		Figure 2(f)	: In drawing, upper "ØN" amended to "ØP(ØG)"	23667
			: "ØP(ØG)" added to Table	23667
		Figure 3	: Deleted in toto	23702
		Figure 4	: Renumbered as "3"	23702
		Para's 4.2.4 & 4.2.5	: In deviation (a), "Shock" changed to "Mechanical Shock"	23702
			: Deviation (b) deleted and remaining deviations renumbered	23702
			: Deviations (c) and (d), paragraph references amended	221319
		Para. 4.3.3	: "Pull Test" added	23702
		Para. 4.4.2	: Title and text amended	23702
		Para. 4.5.1	: Existing text deleted and new text added	23702
		Para. 4.5.2	: Title and text amended	23702
		Para. 4.5.3	: In Testing Level, "(B or C, as applicable)" deleted	23702
		Para. 4.5.4	: In Table, "Coil Resistance" added	23702
		Para. 4.6.1	: Second sentence completed	23702
		Table 2	: 4th column heading amended and applicable paragraph numbers added	23702
			: In 5th column, applicable paragraph numbers added	23702
			: No. 6, existing entry deleted and new entry added, Renumbered as "8" and all subsequent tests renumbered	221319
			: New No. 7, Note reference moved to 5th column	23702
		Table 3	: 4th column heading amended and applicable paragraph numbers added	23702
			: In 5th column, applicable paragraph numbers added	23702
			: No. 6, existing entry deleted and new entry added, Renumbered as "8" and all subsequent tests renumbered	221319
			: New No. 6, Note reference moved from Characteristics to 5th column	23702
		Figure 4	: Entry added	23702
		Table 4	: Title corrected	23702
			: 4th column heading and entry amended	23702
			: In 5th column, all after "9.8" deleted	23702
		Table 5(b)	: No. 2, Characteristics amended	23702
			: No. 3, Symbol, Condition and Unit made part of No. 2	23702



DOCUMENTATION CHANGE NOTICE

Rev. Letter	Rev. Date	Reference	CHANGE Item	Approved DCR No.
		Figure 5(a) Figure 5(b) Para. 4.8 Para's. 4.8.1 to 4.8.3 Para. 4.8.5 Table 6	: Entry added : Entry added : Title expanded : Titles and texts amended : Entry added : Table reformatted : For Items 03 and 09, Contact Voltage Drop Limit amended	23702 23702 23702 23702 23702 23702 221319
'A'	Oct. '97	P1. Cover page P2A. DCN P16. Para. 4.2.4 Para. 4.2.5 P23. Table 6 P24. Table 6	: Deviations (b), (c) and (d) deleted : Deviations (b), (c) and (d) deleted : No. 6, test requirements added : No. 9, "and Para's 4.2.4 and 4.2.5" deleted from "Test Methods and Conditions" : No. 10, test requirements added	None None 221432 221432 221432 221432 221432
'B'	Jun. '00	P1. Cover page P2A. DCN P8. Figure 2(b) P12. Figure 2(f)	: In the Table, dimension 'M max.' amended : In the Table, dimension 'M max.' amended	None None 221570 221570
'C'	Jan. '01	P1. Cover page P2A. DCN P5. Para. 1.1 P6. Table 1(b)	: Title amended : 2nd line text amended : No. 1, Symbol amended and Note 3 added : No. 2, Characteristics, Symbol and Maximum Ratings amended : New Note 3 added	221599 None 221599 221599 221599 221599

**TABLE OF CONTENTS**

	<u>Page</u>
1. <u>GENERAL</u>	5
1.1 Scope	5
1.2 Component Type Variants	5
1.3 Maximum Ratings	5
1.4 Parameter Derating Information	5
1.5 Physical Dimensions	5
1.6 Circuit Schematic	5
2. <u>APPLICABLE DOCUMENTS</u>	5
3. <u>TERMS, DEFINITIONS, ABBREVIATIONS, SYMBOLS AND UNITS</u>	5
4. <u>REQUIREMENTS</u>	16
4.1 General	16
4.2 Deviations from Generic Specification	16
4.2.1 Deviations from Special In-process Controls	16
4.2.2 Deviations from Final Production Tests	16
4.2.3 Deviations from Screening Tests	16
4.2.4 Deviations from Qualification Tests	16
4.2.5 Deviations from Lot Acceptance Tests	16
4.3 Mechanical Requirements	17
4.3.1 Dimension Check	17
4.3.2 Weight	17
4.3.3 Terminal Strength	17
4.4 Materials and Finishes	17
4.4.1 Case	17
4.4.2 Terminal Material and Finish	17
4.5 Marking	17
4.5.1 General	17
4.5.2 Terminal Identification	17
4.5.3 The SCC Component Number	18
4.5.4 Electrical Characteristics	18
4.5.5 Traceability Information	18
4.6 Electrical Measurements	18
4.6.1 Electrical Measurements at Room Temperature	18
4.6.2 Electrical Measurements at High and Low Temperatures	18
4.6.3 Circuits for Electrical Measurements	18
4.7 Screening	18
4.7.1 Miss Test	18
4.7.2 Conditions for Screening	18
4.7.3 Electrical Circuits for Screening	18
4.8 Environmental and Endurance Tests	22
4.8.1 Measurements and Inspections on Completion of Environmental Tests	22
4.8.2 Measurements and Inspections during Endurance Tests	22
4.8.3 Measurements and Inspections on Completion of Endurance Tests	22
4.8.4 Conditions for Operating Life Tests	22
4.8.5 Electrical Circuits for Operating Life Tests	22

**TABLES**

	<u>Page</u>
1(a) Type Variants	6
1(b) Maximum Ratings	6
2 Electrical Measurements at Room Temperature	19
3 Electrical Measurements at High and Low Temperatures	20
4 Measurements during Screening	21
5(a) Conditions for Screening	21
5(b) Conditions for Operating Life Test	21
6 Measurements and Inspections on Completion of Environmental Tests and at Intermediate Points during and on Completion of Endurance Testing	23

FIGURES

1 Not applicable	N/A
2 Physical Dimensions	7
3 Circuit Schematic	15
4 Circuits for Electrical Measurements	21
5(a) Electrical Circuits for Screening	21
5(b) Electrical Circuits for Operating Life Test	21

APPENDICES (Applicable to specific Manufacturers only)

None.

**1. GENERAL****1.1 SCOPE**

This specification details the ratings, physical and electrical characteristics, test and inspection data for a Relay, Electromagnetic, Latching, 50Vdc, 2A, 2PDT, in half-size crystal can, based on Type GP250. It shall be read in conjunction with ESA/SCC Generic Specification No. 3602, the requirements of which are supplemented herein.

1.2 COMPONENT TYPE VARIANTS

Variants of the basic type relays specified herein, which are also covered by this specification, are given in Table 1(a).

1.3 MAXIMUM RATINGS

The maximum ratings, which shall not be exceeded at any time during use or storage, applicable to the relays specified herein, are as scheduled in Table 1(b).

1.4 PARAMETER DERATING INFORMATION (FIGURE 1)

Not applicable.

1.5 PHYSICAL DIMENSIONS

The physical dimensions of the relays specified herein are shown in Figure 2.

1.6 CIRCUIT SCHEMATIC

The circuit schematic, showing lead identification etc. for the relays specified herein, is shown in Figure 3.

2. APPLICABLE DOCUMENTS

The following documents form part of this specification and shall be read in conjunction with it:-

- (a) ESA/SCC Generic Specification No. 3602 for Relays, Electromagnetic, Latching.
- (b) MIL-STD-202, Test Methods for Electronic and Electrical Component Parts.

3. TERMS, DEFINITIONS, ABBREVIATIONS, SYMBOLS AND UNITS

For the purpose of this specification, the terms, definitions, abbreviations, symbols and units specified in ESA/SCC Basic Specification No. 21300 shall apply.

**TABLE 1(a) - TYPE VARIANTS**

VARIANT	DESCRIPTION	FIGURE	LEAD MATERIAL AND FINISH
01	Relay with Plug-in Terminals and Plain Case	2(a)	H3
02	Relay with Plug-in Terminals and Horizontal Shoulder Brackets	2(b)	H3
03	Relay with Solderable, Hook-end Terminals and Vertical Shoulder Brackets	2(c)	H3
04	Relay with Plug-in Terminals and Vertical Shoulder Brackets	2(d)	H3
05	Relay with Solderable, Hook-end Terminals and Plain Case	2(e)	H3
06	Relay with Solderable, Hook-end Terminals and Horizontal Shoulder Brackets	2(f)	H3
07	Relay with Plug-in Terminals and Horizontal Shoulder Brackets (4 Holes)	2(g)	H3
08	Relay with Solderable, Hook-end Terminals and Horizontal Shoulder Brackets (4 Holes)	2(h)	H3

TABLE 1(b) - MAXIMUM RATINGS

No.	CHARACTERISTICS	SYMBOL	MAXIMUM RATING	UNIT	REMARKS
1	Rated Coil Voltage:- 26V 12V	V_{CR}	26.5 12	Vdc	Note 3
2	Maximum Rated Coil Voltage:- 26V 12V	V_{CR}	26.5 to 32 11 to 14.8	Vdc	
3	Rated Contact Current Resistive Load	I_{CR}	2.0	A	50Vdc resistive Note 1
4	Overload Current Resistive	I_{overL}	4.0	A	50Vdc resistive See Table 6
5	Rated Contact Current Inductive Load	I_{CL}	0.4	A	28Vdc inductive 0.32 Henry Note 1
6	Contact Resistance	R_C	50	m Ω	At rated current
7	High Temperature	T_{amb}	+ 125	$^{\circ}C$	
8	Low Temperature	T_{amb}	- 65	$^{\circ}C$	
9	Soldering Temperature	T_{sol}	+ 260	$^{\circ}C$	Note 2

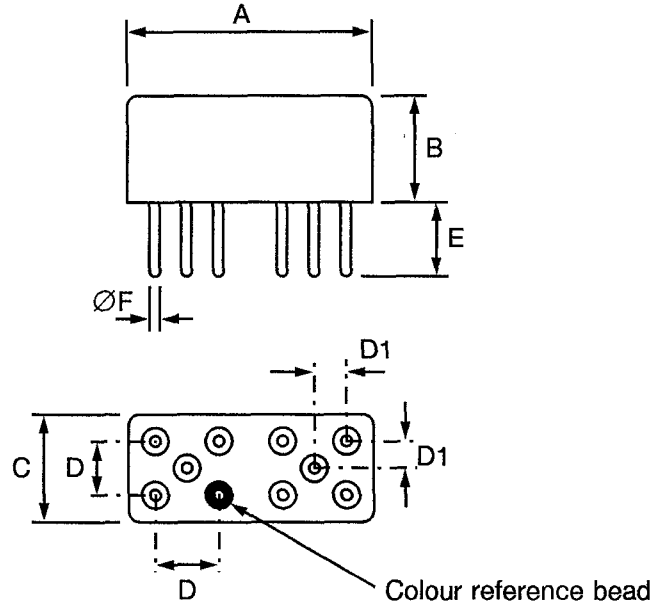
NOTES

- Relays should not be used in change over-mode where the potential difference between stationary contacts is greater than 10V and the switched current is greater than 0.1A.
- Duration 10 seconds maximum at a distance of not less than 3.0mm from the device body and the same terminal shall not be resoldered until 3 minutes have elapsed.
- The Coil Voltage rise time shall be less than $0.1t_L$ or t_r . The coil voltage shall be applied for a minimum time of $10t_L$ or $10t_r$.



FIGURE 2 - PHYSICAL DIMENSIONS

FIGURE 2(a) - VARIANT 01, RELAY WITH PLUG-IN TERMINALS AND PLAIN CASE

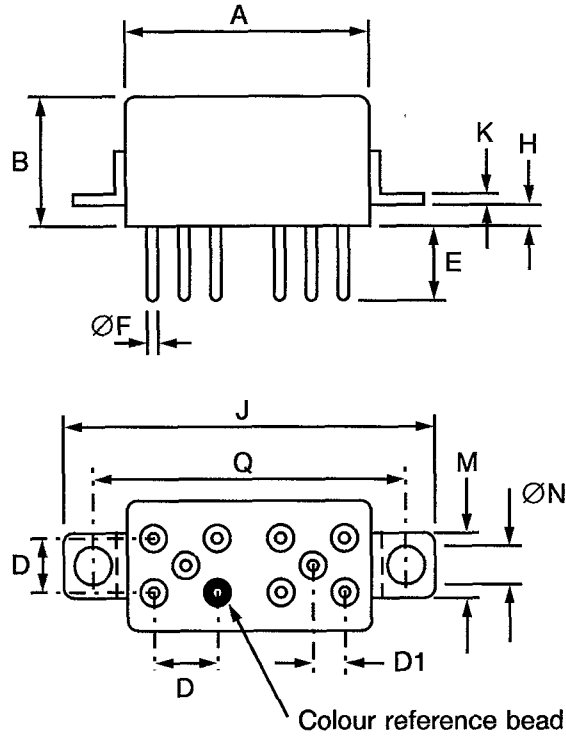


SYMBOL	MILLIMETRES	
	MIN.	MAX.
A	-	20.57
B	-	10.41
C	-	10.41
D	4.98	5.18
D1	2.40	2.70
E	4.24	5.40
$\text{Ø}F$	0.66	0.86

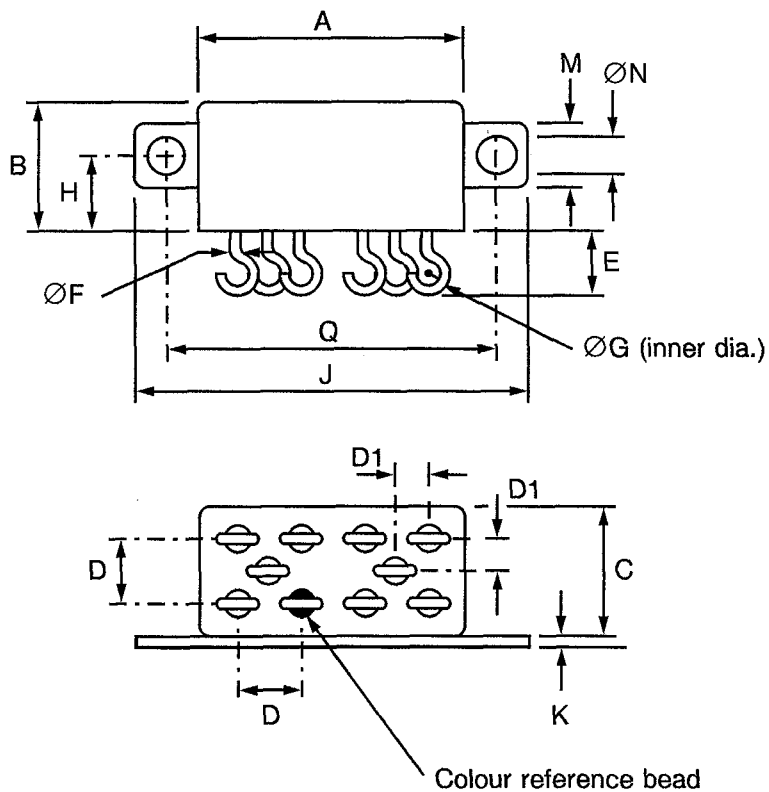


FIGURE 2 - PHYSICAL DIMENSIONS (CONTINUED)

FIGURE 2(b) - VARIANT 02, RELAY WITH PLUG-IN TERMINALS AND HORIZONTAL SHOULDER BRACKETS



SYMBOL	MILLIMETRES	
	MIN.	MAX.
A	-	20.57
B	-	10.41
D	4.98	5.18
D1	2.40	2.70
E	4.24	5.40
ØF	0.66	0.86
H	3.05	3.30
J	-	32.90
K	0.51	0.76
M	6.22	8.10
ØN	3.00	3.55
Q	26.60	27.40

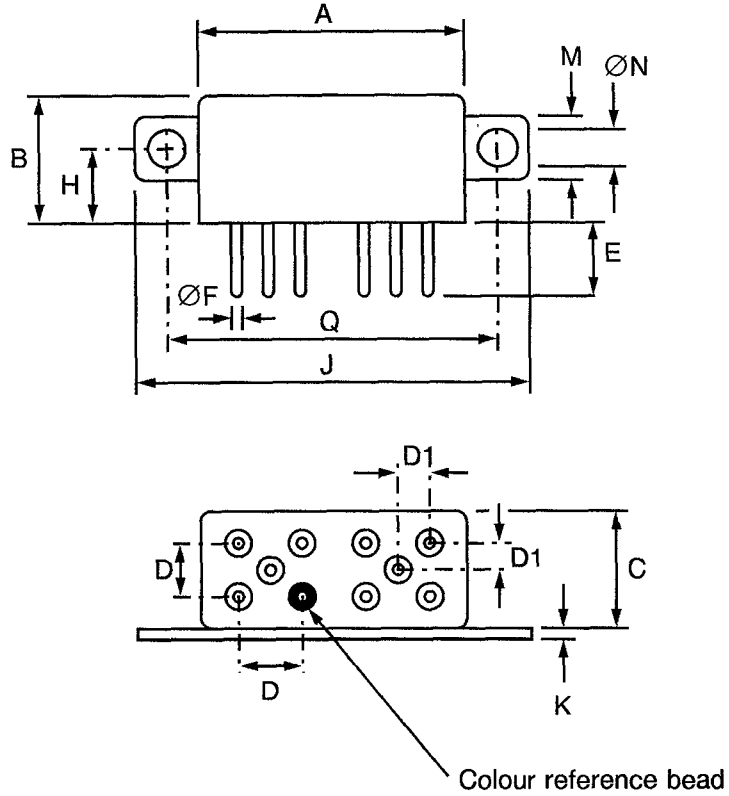
FIGURE 2 - PHYSICAL DIMENSIONS (CONTINUED)
FIGURE 2(c) - VARIANT 03, RELAY WITH SOLDERABLE, HOOK-END TERMINALS AND VERTICAL SHOULDER BRACKETS


SYMBOL	MILLIMETRES	
	MIN.	MAX.
A	-	20.57
B	-	10.41
C	-	11.00
D	4.98	5.18
D1	2.40	2.70
E	4.11	4.83
ØF	0.66	0.86
ØG	-	1.80
H	5.97	6.73
J	-	32.64
K	0.38	0.80
M	6.22	8.00
ØN	3.00	3.55
Q	26.80	27.20



FIGURE 2 - PHYSICAL DIMENSIONS (CONTINUED)

FIGURE 2(d) - VARIANT 04, RELAY WITH PLUG-IN TERMINALS AND VERTICAL SHOULDER BRACKETS

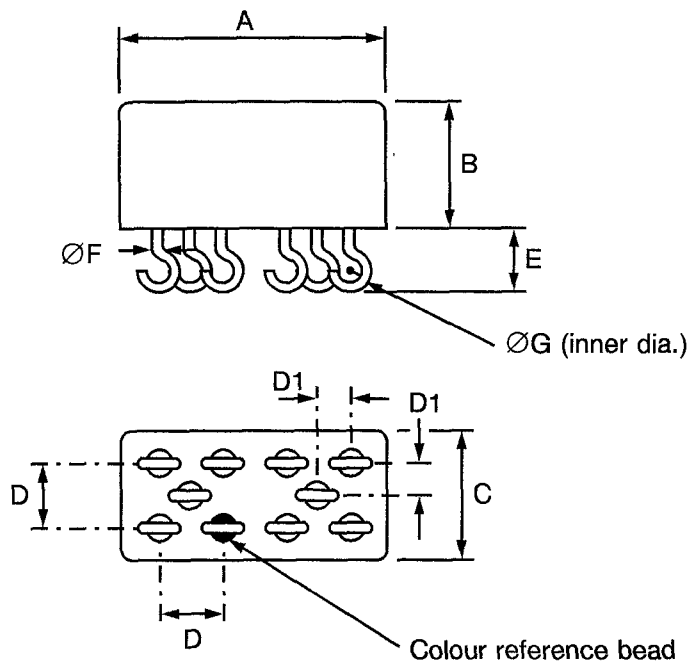


SYMBOL	MILLIMETRES	
	MIN.	MAX.
A	-	20.57
B	-	10.41
C	-	10.41
D	4.98	5.18
D1	2.40	2.70
E	4.24	5.40
ØF	0.66	0.86
H	5.97	6.73
J	-	32.64
K	0.38	0.80
M	6.22	8.00
ØN	3.00	3.55
Q	26.80	27.20



FIGURE 2 - PHYSICAL DIMENSIONS (CONTINUED)

FIGURE 2(e) - VARIANT 05, RELAY WITH SOLDERABLE, HOOK-END TERMINALS AND PLAIN CASE

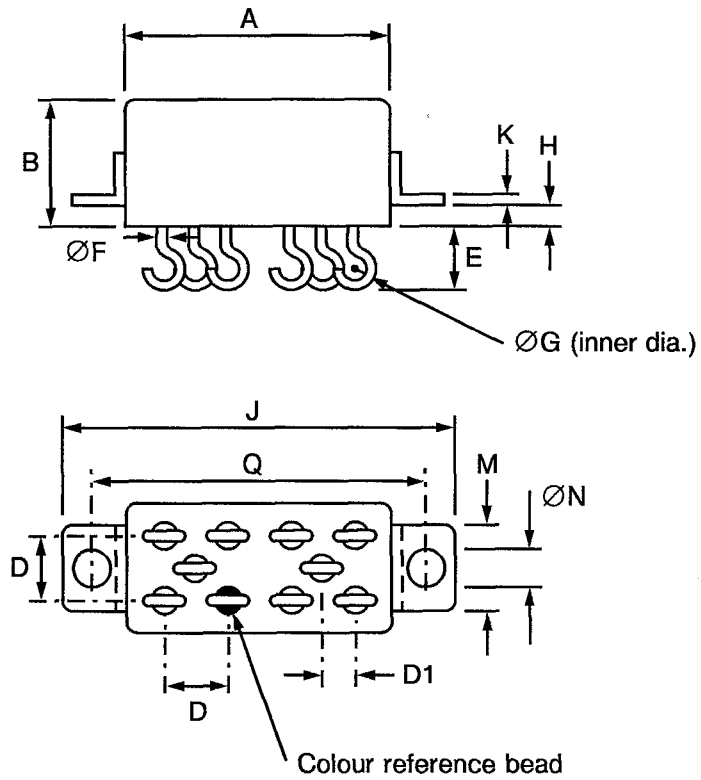


SYMBOL	MILLIMETRES	
	MIN.	MAX.
A	-	20.57
B	-	10.41
C	-	10.41
D	4.98	5.18
D1	2.40	2.70
E	4.11	4.83
ØF	0.66	0.86
ØG	-	1.80



FIGURE 2 - PHYSICAL DIMENSIONS (CONTINUED)

FIGURE 2(f) - VARIANT 06, RELAY WITH SOLDERABLE, HOOK-END TERMINALS AND HORIZONTAL SHOULDER BRACKETS

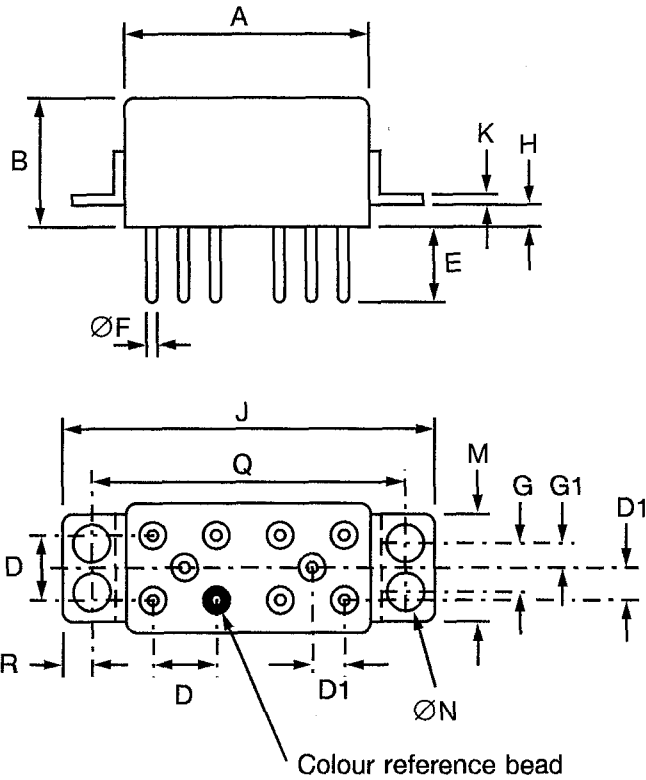


SYMBOL	MILLIMETRES	
	MIN.	MAX.
A	-	20.57
B	-	10.41
D	4.98	5.18
D1	2.40	2.70
E	4.11	4.83
ØF	0.66	0.86
ØG	-	1.80
H	3.05	3.30
J	-	32.90
K	0.51	0.76
M	6.22	8.10
ØN	3.00	3.55
Q	26.60	27.40



FIGURE 2 - PHYSICAL DIMENSIONS (CONTINUED)

FIGURE 2(g) - VARIANT 07, RELAY WITH PLUG-IN TERMINALS AND HORIZONTAL SHOULDER BRACKETS (4 HOLES)

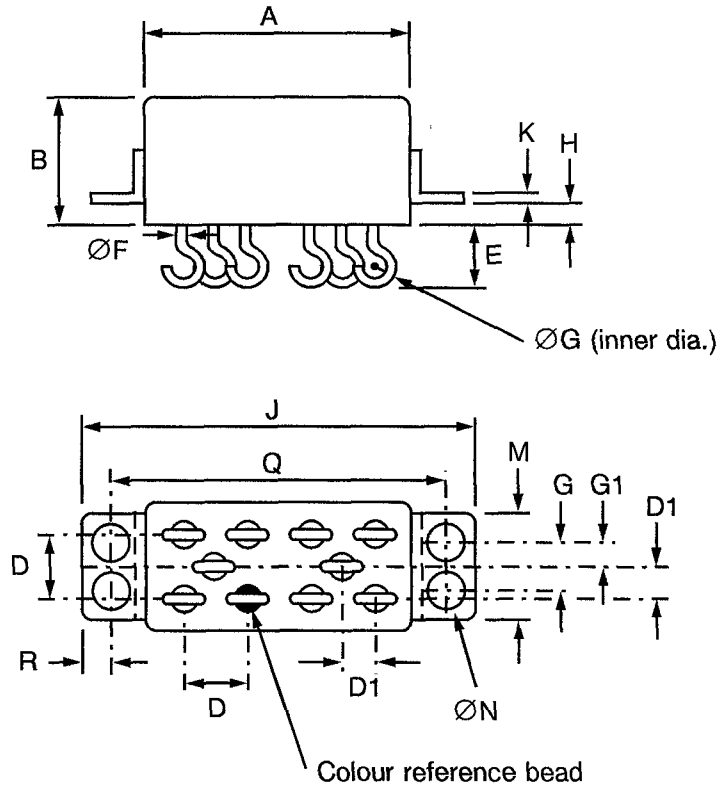


SYMBOL	MILLIMETRES	
	MIN.	MAX.
A	-	20.30
B	-	10.40
D	5.00	5.20
D1	2.40	2.70
E	4.80	5.30
ØF	0.66	0.86
G	3.10	3.30
G1	1.50	1.70
H	3.10	3.30
J	29.80	30.00
K	0.50	0.80
M	9.30	9.70
ØN	2.20	2.60
Q	25.30	25.50
R	2.20	2.40



FIGURE 2 - PHYSICAL DIMENSIONS (CONTINUED)

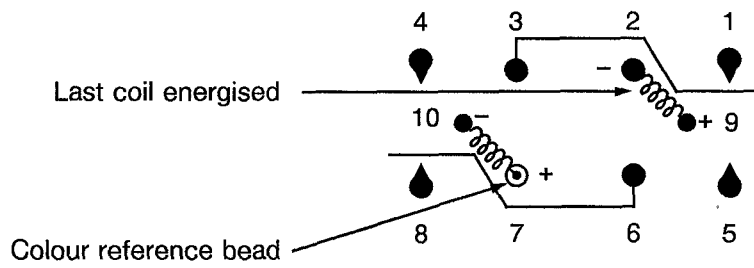
FIGURE 2(h) - VARIANT 08, RELAY WITH SOLDERABLE HOOK-END TERMINALS AND HORIZONTAL SHOULDER BRACKETS (4 HOLES)



SYMBOL	MILLIMETRES	
	MIN.	MAX.
A	-	20.30
B	-	10.40
D	5.00	5.20
D1	2.40	2.70
E	4.10	4.80
ØF	0.64	0.89
G	3.10	3.30
ØG	1.70	1.90
G1	1.50	1.70
H	3.10	3.30
J	29.80	30.00
K	0.50	0.80
M	9.30	9.70
ØN	2.20	2.60
Q	25.30	25.50
R	2.20	2.40



FIGURE 3 - CIRCUIT SCHEMATIC



NOTES

1. Numbers are for information only.

LEAD IDENTIFICATION AS VIEWED FROM HEADER



4. REQUIREMENTS

4.1 GENERAL

The complete requirements for procurement of the relays specified herein shall be as stated in this specification and ESA/SCC Generic Specification No. 3602 for Relays, Electromagnetic Latching. Deviations from the Generic Specification, applicable to this specification only, are listed in Para. 4.2.

Deviations from the applicable Generic Specification and this Detail Specification, formally agreed with specific Manufacturers on the basis that the alternative requirements are equivalent to the ESA/SCC requirements and do not affect the components' reliability, are listed in the appendices attached to this specification.

4.2 DEVIATIONS FROM GENERIC SPECIFICATION

4.2.1 Deviations from Special In-process Controls

None.

4.2.2 Deviations from Final Production Tests (Chart II)

None.

4.2.3 Deviations from Screening Tests (Chart III)

None.

4.2.4 Deviations from Qualification Tests (Chart IV)

(a) Para. 9.11, Mechanical Shock: Test Condition 'A'.

4.2.5 Deviations from Lot Acceptance Tests (Chart V)

(a) Para. 9.11, Mechanical Shock: Test Condition 'A'.



4.3 MECHANICAL REQUIREMENTS

4.3.1 Dimension Check

The dimensions of the relays specified herein shall be verified in accordance with the requirements set out in Para. 9.5 of ESA/SCC Generic Specification No. 3602 and shall conform to those shown in Figure 2.

4.3.2 Weight

The maximum weight of the relays specified herein shall be 8.5 grammes.

4.3.3 Terminal Strength

The requirements for terminal strength testing are specified in Section 9 of ESA/SCC Generic Specification No. 3602. The test conditions shall be as follows:-

Pull Test

Applied Force: 14 ± 1.4 Newtons.

Duration: 10 seconds.

4.4 MATERIALS AND FINISHES

The materials and finishes shall be as specified herein. Where a definite material is not specified, a material which will enable the relays specified herein to meet the performance requirements of this specification shall be used. Acceptance or approval of any constituent material does not guarantee acceptance of the finished product.

4.4.1 Case

Copper nickel, welded construction. Electro-deposited tin shall not be used. EP 90/10 SnPb alloy may be used.

4.4.2 Terminal Material and Finish

The terminal material shall be Type 'H' with Type '3' finish in accordance with the requirements of ESA/SCC Basic Specification No. 23500. (See Table 1(a) for Type Variants).

4.5 MARKING

4.5.1 General

The marking of all components delivered to this specification shall be in accordance with the requirements of ESA/SCC Basic Specification No. 21700 and the following paragraphs. When the component is too small to accommodate all of the marking specified, as much as space permits shall be marked and the marking information, in full, shall accompany the component in its primary package.

The information to be marked and the order of precedence, shall be as follows:-

- (a) Terminal Identification.
- (b) The SCC Component Number.
- (c) Electrical Characteristics.
- (d) Traceability Information.

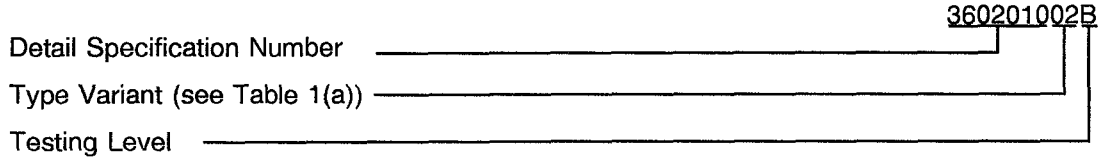
4.5.2 Terminal Identification

Terminal identification shall be marked on the relay can in accordance with Figure 3.



4.5.3 The SCC Component Number

Each component shall bear the SCC Component Number which shall be constituted and marked as follows:



4.5.4 Electrical Characteristics

The electrical characteristic to be marked is the rated coil voltage. The information shall be constituted and marked as follows:-

Coil Voltage	Coil Resistance	Code
26.5Vdc	750Ω	26V
12Vdc	150Ω	12V

4.5.5 Traceability Information

Each component shall be marked in respect of traceability information as defined in ESA/SCC Basic Specification No. 21700.

4.6 ELECTRICAL MEASUREMENTS

4.6.1 Electrical Measurements at Room Temperature

The parameters to be measured at room temperature are scheduled in Table 2. Unless otherwise specified, the measurements shall be performed at $T_{amb} = +22 \pm 3$ °C.

4.6.2 Electrical Measurements at High and Low Temperatures

The parameters to be measured at high and low temperatures are scheduled in Table 3.

4.6.3 Circuits for Electrical Measurements (Figure 4)

Not applicable.

4.7 SCREENING

4.7.1 Miss Test

During the miss test, the contact resistance shall be continuously monitored and shall not exceed the values specified in Table 4 of this specification.

4.7.2 Conditions for Screening

The requirements for screening are specified in Section 7 of ESA/SCC Generic Specification No. 3602. The conditions for screening shall be as specified in Table 5(a) of this specification.

4.7.3 Electrical Circuits for Screening (Figure 5(a))

Not applicable.

**TABLE 2 - ELECTRICAL MEASUREMENTS AT ROOM TEMPERATURE**

No.	CHARACTERISTICS	SYMBOL	ESA/SCC 3602 TEST METHOD	TEST CONDITION	LIMITS		UNIT
					MIN.	MAX.	
1	Latch Voltage:- 26V 12V	U_L	Para. 9.3.1	Para. 9.3.1	7.5 3.5	13.5 6.8	V
2	Reset Voltage:- 26V 12V	U_R	Para. 9.3.2	Para. 9.3.2	7.5 3.5	13.5 6.8	V
3	Latch Time	t_L	Para. 9.3.4	Para. 9.3.4	-	4.0	ms
4	Reset Time	t_r	Para. 9.3.4	Para. 9.3.4	-	4.0	ms
5	Bounce Time	t_b	Para. 9.3.4	Para. 9.3.4	-	2.0	ms
6	Insulation Resistance	R_i	Para. 9.3.7	Para. 9.3.7 At 100Vdc	10000	-	$M\Omega$
7	Voltage Proof	VP	Para. 9.3.6	Para. 9.3.6 Note 1	1000	-	Vrms
8	Contact Voltage Drop	V_d	Para. 9.3.3	Para. 9.3.3	-	5.0	mV
9	Coil Resistance Latch Coil	R_{BL}	Para. 9.3.5	Para. 9.3.5	648	792	Ω
	26V				135	165	
	Reset Coil	R_{BR}	Para. 9.3.5	Para. 9.3.5	648	792	Ω
	26V				135	165	
	12V						

NOTES

1. 500V between coil and case, between open contacts, between coils.

**TABLE 3 - ELECTRICAL MEASUREMENTS AT HIGH AND LOW TEMPERATURES**

No.	CHARACTERISTICS	SYMBOL	ESA/SCC 3602 TEST METHOD	TEST CONDITION	LIMITS		UNIT
					MIN.	MAX.	
1	Latch Voltage:- 26V 12V	U_L	Para. 9.3.1	Para. 9.3.1	- -	18 9.8	V
2	Reset Voltage:- 26V 12V	U_R	Para. 9.3.2	Para. 9.3.2	- -	18 9.8	V
3	Latch Time	t_L	Para. 9.3.4	Para. 9.3.4	-	5.0	ms
4	Reset Time	t_r	Para. 9.3.4	Para. 9.3.4	-	5.0	ms
5	Bounce Time	t_b	Para. 9.3.4	Para. 9.3.4	-	2.0	ms
6	Insulation Resistance	R_i	Para. 9.3.7	Para. 9.3.7 At 100Vdc Note 1	100	-	$M\Omega$
8	Contact Voltage Drop	V_d	Para. 9.3.3	Para. 9.3.3	-	10	mV

NOTES

1. This measurement shall be made only at the high temperature condition.

FIGURE 4 - CIRCUITS FOR ELECTRICAL MEASUREMENTS

Not applicable.

TABLE 4 - MEASUREMENTS DURING SCREENING

No.	CHARACTERISTICS	SYMBOL	ESA/SCC 3602 TEST METHOD	TEST CONDITIONS	MAXIMUM LIMIT	UNIT
10	Miss Test, Contact Resistance	R _C	Para. 9.8	Para. 9.8	100	Ω

TABLE 5(a) - CONDITIONS FOR SCREENING

No.	CHARACTERISTICS	SYMBOL	CONDITION	UNIT
1	Ambient High Temperature	T _{amb}	+ 125(+ 0 - 3)	°C
2	Ambient Low Temperature	T _{amb}	- 65(+ 3 - 0)	°C
3	Ambient Room Temperature	T _{amb}	+ 22 ± 3	°C

TABLE 5(b) - CONDITIONS FOR OPERATING LIFE TEST

No.	CHARACTERISTICS	SYMBOL	CONDITION	UNIT
1	Ambient High Temperature	T _{amb}	+ 125(+ 0 - 3)	°C
2	Contact Load Resistive	V I	50 2.0	Vdc Adc

FIGURE 5(a) - ELECTRICAL CIRCUITS FOR SCREENING

Not applicable.

FIGURE 5(b) - ELECTRICAL CIRCUITS FOR OPERATING LIFE TEST

Not applicable.



- 4.8 ENVIRONMENTAL AND ENDURANCE TESTS (CHARTS IV AND V OF ESA/SCC GENERIC SPECIFICATION No. 3602)
- 4.8.1 Measurements and Inspections on Completion of Environmental Tests
The parameters to be measured and inspections to be performed on completion of environmental tests are scheduled in Table 6. Unless otherwise stated, the measurements shall be performed at $T_{amb} = +22 \pm 3$ °C.
- 4.8.2 Measurements and Inspections during Endurance Tests
The parameters to be measured and inspections to be performed during endurance tests are scheduled in Table 6. Unless otherwise stated, the measurements shall be performed at $T_{amb} = +22 \pm 3$ °C.
- 4.8.3 Measurements and Inspections on Completion of Endurance Tests
The parameters to be measured and inspections to be performed on completion of endurance tests are scheduled in Table 6. Unless otherwise stated, the measurements shall be performed at $T_{amb} = +22 \pm 3$ °C.
- 4.8.4 Conditions for Operating Life Tests (Part of Endurance Testing)
The requirements for operating life testing are specified in Section 9 of ESA/SCC Generic Specification No. 3602. The conditions for operating life testing shall be as specified in Table 5(b) of this specification.
- 4.8.5 Electrical Circuits for Operating Life Tests (Figure 5(b))
Not applicable.

TABLE 6 - MEASUREMENTS AND INSPECTIONS ON COMPLETION OF ENVIRONMENTAL TESTS AND AT INTERMEDIATE POINTS AND ON COMPLETION OF ENDURANCE TESTING

No.	ESA/SCC GENERIC SPEC. NO. 3602		MEASUREMENTS AND INSPECTIONS		SYMBOL	LIMITS		UNIT
	ENVIRONMENTAL AND ENDURANCE TESTS (1)	TEST METHOD AND CONDITIONS	IDENTIFICATION	CONDITIONS		MIN.	MAX.	
01	Vibration	Para. 9.10 and Para. 4.2.4 of this spec.	Measurements during Test Contact Monitoring Final Measurements Visual Examination	ESA/SCC 3602 Para. 9.10 -	- -	- -	- -	- -
02	Mechanical Shock	Para. 9.11 and Para. 4.2.4 of this spec.	Measurements during Test Contact Monitoring Final Measurements Electrical Measurements Visual Examination	ESA/SCC 3602 Para. 9.11 Table 2 Items 7-8-1-2 -	- -	- -	- -	- -
03	Overload	Para. 9.12 and Table 1(b) Item 4 of this spec.	Measurements during Test Contact Voltage Drop Final Measurements Fuse Continuity Contact Voltage Drop (3) Insulation Resistance Voltage Proof (all Points) (2) Electrical Measurements	ESA/SCC 3602 Para. 9.12.1 - Table 2 Item 8 Table 2 Item 6 Table 2 Item 7 Table 2 Items 1-2-3-4-5-9	V _d - V _d R _i VP	Para. 9.12.1 Continuity - 20 50 - 1000 - Table 2	mV mV MΩ Vrms	
04	Thermal Shock	Para. 9.13	During 5th Cycle Electrical Measurements at +125°C Electrical Measurements at -65°C Final Measurements Visual Examination Voltage Proof (all Points)	In Conditioning Chamber Table 3 Items 1-2-3-4-6 Table 3 Items 1-2-3-4 - Table 2 Item 7	- - VP	Table 3 Table 3 - -	- -	- -
05	Salt Spray	Para. 9.14	Final Measurements Visual Examination Electrical Measurements Voltage Proof (all Points) (2)	- Table 2 Items 1-2-3-4-5-6-8-9 Table 2 Item 7	- - VP	- -	- -	- -
06	Intermediate Current	Para. 9.16	Measurements during Test Contact Voltage Drop Final Measurements Insulation Resistance Voltage Proof (all Points) (2) Electrical Measurements Contact Voltage Drop	ESA/SCC 3602 Para. 9.16.1 Table 2 Item 6 Table 2 Item 7 Table 2 Items 1-2-3-4-5-9 ESA/SCC 3602 Para. 9.16.1	V _d R _i VP V _d	Para. 9.16.1 50 - 1000 - Table 2 Para. 9.16.1	mV mΩ Vrms mV	
07	Terminal Strength	Para. 9.17 and Para. 4.3.3 of this spec.	Visual Examination	ESA/SCC 3602 Para. 9.17.3	-	-	-	-

NOTES

1. The tests in this table refer to either Chart IV or V and shall be used as applicable.
2. 500Vrms between coils.
3. Reading time 5 - 10 seconds, if required.



TABLE 6 - MEASUREMENTS AND INSPECTIONS ON COMPLETION OF ENVIRONMENTAL TESTS AND AT INTERMEDIATE POINTS AND ON COMPLETION OF ENDURANCE TESTING (CONT'D)

No.	ESA/SCC GENERIC SPEC. NO. 3602		MEASUREMENTS AND INSPECTIONS		SYMBOL	LIMITS		UNIT
	ENVIRONMENTAL AND ENDURANCE TESTS (1)	TEST METHOD AND CONDITIONS	IDENTIFICATION	CONDITIONS		MIN.	MAX.	
08	Resistance to Soldering Heat	Para. 9.18	Electrical Measurements	Table 2 Items 1-2-6-8-9		Table 2		
09	Operating Life Resistive	Para's 9.19, 9.19.1 and Table 5(b) of this spec.	Measurements during Test Contact Voltage Drop Final Measurements Fuse Continuity Contact Voltage Drop (3) Insulation Resistance Voltage Proof (all Points) (2) Electrical Measurements	ESA/SCC 3602 Para. 9.19.1 - Table 2 Item 8 Table 2 Item 6 Table 2 Item 7 Table 2 Items 1-2-3-4-5-9	V _d - V _d Ri VP	Para. 9.19.1 Continuity - 20 50 - 1000 - Table 2	mV mV MΩ Vrms	
10	Operating Life Low Level Load and Mechanical Life	Para. 9.19.2	Measurements during Test Contact Voltage Drop Final Measurements Contact Voltage Drop (3) Insulation Resistance Voltage Proof (all Points) (2) Electrical Measurements	ESA/SCC 3602 Para. 9.19.2 Table 2 Item 8 Table 2 Item 6 Table 2 Item 7 Table 2 Items 1-2-3-4-5-9	V _d V _d Ri VP	Para. 9.19.2 - 10 50 - 1000 - Table 2	mV mV mΩ Vrms	

NOTES

1. The tests in this table refer to either Chart IV or V and shall be used as applicable.
2. 500Vrms between coils.
3. Reading time 5 - 10 seconds, if required.