



europaean space agency
agence spatiale européenne

Pages 1 to 21

**RESISTORS, FIXED, WIREWOUND, POWER-TYPE,
CHASSIS-MOUNTED, 5 WATT, SEMI-PRECISION
BASED ON TYPE RER40**

ESA/SCC Detail Specification No. 4003/004



**space components
coordination group**

Issue/Rev.	Date	Approved by	
		SCCG Chairman	ESA Director General or his Deputy
Issue 2	April 1979		
Revision 'A'	May 1993		
Revision 'B'	November 1996		



	ESA/SCC Detail Specification No. 4003/004		PAGE 3 ISSUE 2
---	--	--	-------------------

TABLE OF CONTENTS

		<u>Page</u>
1.	<u>GENERAL</u>	5
1.1	Scope	5
1.2	Range of Components	5
1.3	Maximum Ratings	5
1.4	Parameter Derating Information	5
1.5	Physical Dimensions	5
1.6	Functional Diagram	5
2.	<u>APPLICABLE DOCUMENTS</u>	5
3.	<u>TERMS, DEFINITIONS, ABBREVIATIONS, SYMBOLS AND UNITS</u>	10
4.	<u>REQUIREMENTS</u>	10
4.1	General	10
4.2	Deviations from Generic Specification	10
4.2.1	Deviations from Special In-process Controls	10
4.2.2	Deviations from Final Production Tests (Chart II)	10
4.2.3	Deviations from Burn-in and Electrical Measurements (Chart III)	10
4.2.4	Deviations from Qualification Tests (Chart IV)	10
4.2.5	Deviations from Lot Acceptance Tests (Chart V)	10
4.3	Mechanical Requirements	10
4.3.1	Dimension Check	10
4.3.2	Weight	11
4.3.3	Robustness of Terminations	11
4.4	Materials and Finishes	11
4.4.1	Housing	11
4.4.2	Terminals	11
4.4.3	Wire	11
4.5	Marking	12
4.5.1	General	12
4.5.2	The SCC Component Number	12
4.5.3	Electrical Characteristics and Ratings	12
4.5.4	Traceability Information	14
4.5.5	Marking of Small Components	14

 	<p style="text-align: center;">ESA/SCC Detail Specification No. 4003/004</p>	<p style="text-align: center;">Rev. 'A'</p>	<p>PAGE 4 ISSUE 2</p>
---	--	---	---------------------------

	<u>Page</u>
4.6 Electrical Measurements	14
4.6.1 Electrical Measurements at Room Temperature	14
4.6.2 Electrical Measurements at High and Low Temperatures	14
4.6.3 Circuits for Electrical Measurements	14
4.7 Burn-in Tests	18
4.7.1 Parameter Drift Values	18
4.7.2 Conditions for Burn-in	18
4.7.3 Electrical Circuits for Burn-in	18
4.8 Environmental and Endurance Tests	18
4.8.1 Electrical Measurements on Completion of Environmental Tests	18
4.8.2 Electrical Measurements at Intermediate Points during Endurance Tests	18
4.8.3 Electrical Measurements on Completion of Endurance Tests	21
4.8.4 Conditions for Operating Life Tests (Part of Endurance Testing)	21
4.8.5 Electrical Circuits for Operating Life Tests	21
4.8.6 Conditions for High Temperature Storage Test (Part of Endurance Testing)	21

TABLES



1(a) Range of Components	6
1(b) Maximum Ratings	7
2 Electrical Measurements at Room Temperature	15
3 Electrical Measurements at High and Low Temperatures	16
4 Parameter Drift Values	19
5(a) Conditions for Burn-in Tests	19
5(b) Conditions for Operating Life Tests	19
6 Electrical Measurements on Completion of Environmental Tests and at Intermediate Points and on Completion of Endurance Testing	20

FIGURES

1 Rated Dissipation versus Temperature	8
2 Physical Dimensions	9
3 Functional Diagram	9
4(a) Test Circuit for Reactance Measurement	17
4(b) Oscilloscope Trace	17
5 Circuit for Burn-in and Operating Life Tests	19

APPENDICES (Applicable to specific Manufacturers only)

None.

 	<p style="text-align: center;">ESA/SCC Detail Specification No. 4003/004</p>	<p style="text-align: center;">Rev. 'A'</p>	<p>PAGE 5 ISSUE 2</p>
---	--	---	---------------------------

1. GENERAL

1.1 SCOPE

This specification details the ratings, physical and electrical characteristics, test and inspection data for Resistors, Fixed, Wirewound, Power-type, Chassis-mounted, 5 Watt, Semi-Precision, based on Type RER 40.

It shall be read in conjunction with ESA/SCC Generic Specification No. 4003, the requirements of which are supplemented herein.

1.2 RANGE OF COMPONENTS

The range of resistors covered by this specification is scheduled in Table 1(a).

1.3 MAXIMUM RATINGS

The maximum ratings, which shall not be exceeded at any time during use or storage, applicable to the resistors specified herein, are scheduled in Table 1(b).

1.4 PARAMETER DERATING INFORMATION

The applicable derating information for the resistors specified herein is given in Figure 1.

1.5 PHYSICAL DIMENSIONS

The physical dimensions of the resistors specified herein are shown in Figure 2.

1.6 FUNCTIONAL DIAGRAM

The functional diagram for the resistors specified herein is shown in Figure 3.

2. APPLICABLE DOCUMENTS

The following documents form part of this specification and shall be read in conjunction with it:-

- (a) ESA/SCC Generic Specification No. 4003, Resistors, Fixed, Wirewound, Power-type, Chassis-mounted.

TABLE 1(a) - RANGE OF COMPONENTS

Tolerance (%)	Resistance Range (Note 1) R_n (Ω)	Temperature Characteristic of Resistance (ppm/ $^{\circ}$ C)	Resistance Range (Note 1) R_n (Ω)
± 1.0	75 to 1500	± 30	$R_n > 2000$
± 2.0	0.3 to 1500	± 50	$0.1 < R_n < 2000$
± 5.0	0.15 to 1500	± 100	$R_n < 0.1$
± 10	0.05 to 1500		

NOTES

1. The critical value is outside the resistance range.



TABLE 1(b) - MAXIMUM RATINGS

No.	Characteristics	Symbol	Maximum Rating	Unit	Remarks
1	Rated Dissipation for Resistors Mounted on Chassis (Note 1)	P_n	5.0	W	Up to $T_{amb} = +25^{\circ}\text{C}$
			4.0		At $T_{amb} = +70^{\circ}\text{C}$
2	Rated Dissipation for Unmounted Resistors	P_n	4.0	W	Up to $T_{amb} = +25^{\circ}\text{C}$
			3.2		At $T_{amb} = +70^{\circ}\text{C}$
3(a)	Lower Category Temperature	T_{amb}	-55	$^{\circ}\text{C}$	+275° at zero wattage. It is the maximum storage temperature
3(b)	Upper Category Temperature		+275		
4	Limiting Element Voltage	U_L	160	V	
5	Rated Voltage	U_R	$\sqrt{5 R_n}$	V	At $T_{amb} = +25^{\circ}\text{C}$
6	Voltage Proof	U_{proof}	1000	Vrms	At atmospheric pressure
7	Voltage Proof	U_{proof}	500	Vrms	At reduced barometric pressure
8	Overload Voltage and Time Mounted on Chassis	$U_{over L}$	$\sqrt{25 R_n}$	Vac	At $T_{amb} = +25^{\circ}\text{C}$
		t	5.0	s	

NOTES

1. The approximate dimensions of the chassis shall be:-

- Length = 153mm
- Width = 102mm
- Height = 51mm
- Thickness = 1.0mm

Approx. area = 400cm².

See ESA/SCC Generic Specification No. 4003, Para. 9.1.1, for the mounting procedure.



FIGURE 1 - RATED DISSIPATION VERSUS TEMPERATURE

(For resistors mounted on chassis)

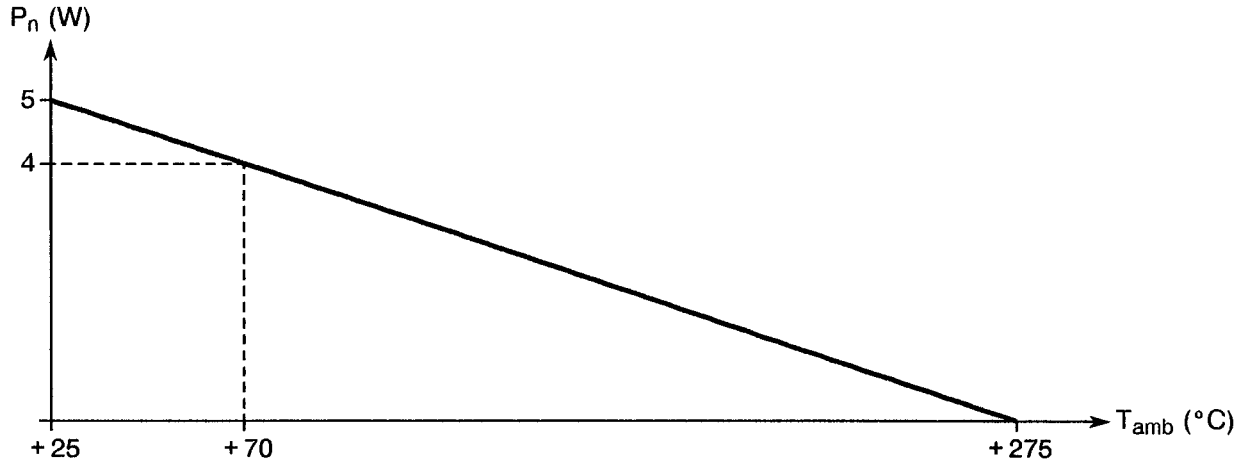
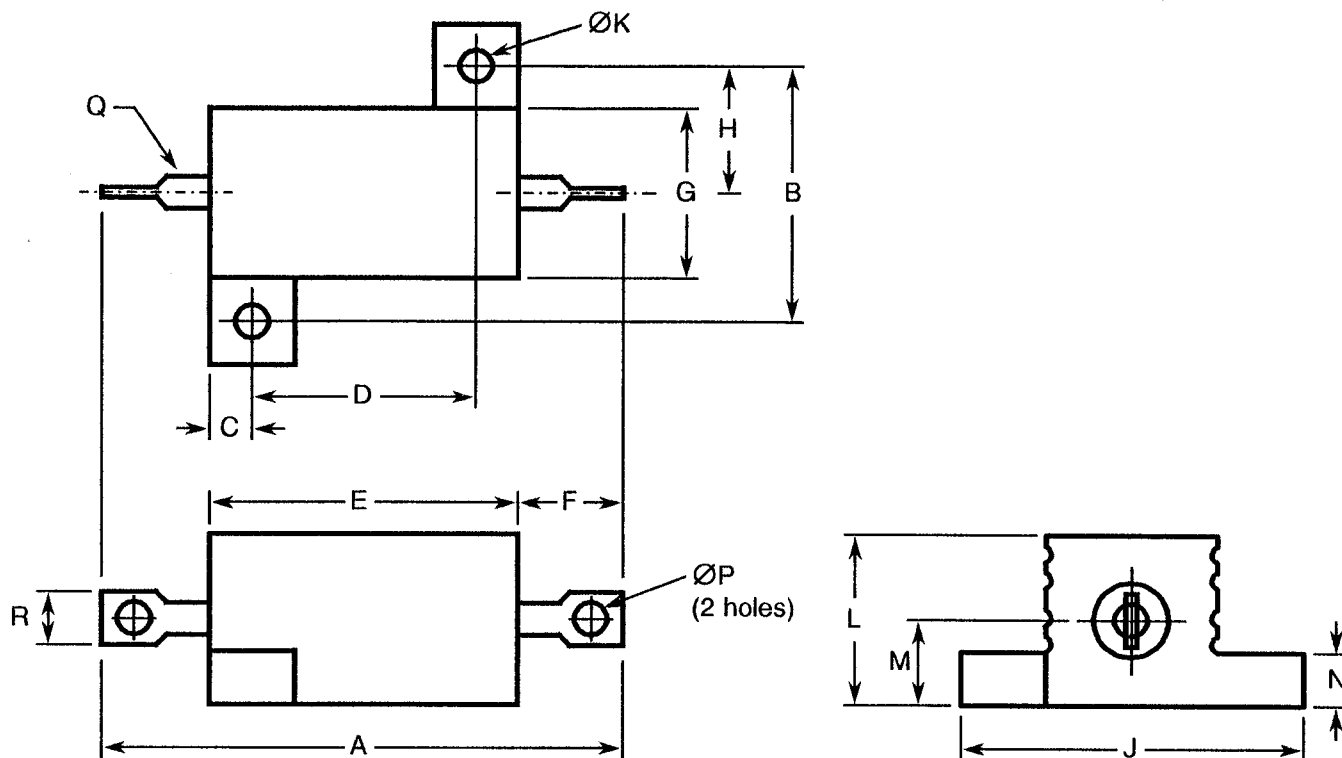
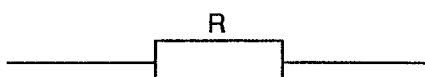



FIGURE 2 - PHYSICAL DIMENSIONS

SYMBOL	MILLIMETRES	
	MIN.	MAX.
A	27.10	30.15
B	12.20	12.70
C	1.19	2.77
D	11.03	11.23
E	13.67	16.81
F	5.19	8.33
G	6.91	10.05
H	5.43	7.01
J	15.62	17.20
ØK	2.23	2.49
L	7.34	8.92
M	1.81	4.95
N	0.86	2.44
ØP	1.14	1.40
Q	1.20	1.40
R	2.16	-

FIGURE 3 - FUNCTIONAL DIAGRAM

 	<p style="text-align: center;">ESA/SCC Detail Specification No. 4003/004</p>	<p style="text-align: center;">Rev. 'A'</p>	<p>PAGE 10 ISSUE 2</p>
---	--	---	----------------------------

3. TERMS, DEFINITIONS, ABBREVIATIONS, SYMBOLS AND UNITS

For the purpose of this specification, the terms, definitions, abbreviations, symbols and units specified in ESA/SCC Basic Specification No. 21300 shall apply. In addition, the following symbols are used:-

- R_A = Resistance value measured at room ambient temperature ($+22 \pm 3^\circ\text{C}$).
- R_i = Insulation resistance.
- U_T = Test voltage.
- U_{proof} = d.c. or r.m.s. voltage proof.
- $U_{\text{over L}}$ = Overload voltage.

4. REQUIREMENTS

4.1 GENERAL

The complete requirements for procurement of the resistors specified herein shall be as stated in this specification and ESA/SCC Generic Specification No. 4003 for Resistors, Fixed, Wirewound, Power-type, Chassis-mounted. Deviations from the Generic Specification, applicable to this specification only, are listed in Para. 4.2.

Deviations from the applicable Generic Specification and this Detail Specification, formally agreed with specific Manufacturers on the basis that the alternative requirements are equivalent to the ESA/SCC requirements and do not affect the components' reliability, are listed in the appendices attached to this specification.

4.2 DEVIATIONS FROM GENERIC SPECIFICATION

4.2.1 Deviations from Special In-process Controls

None.

4.2.2 Deviations from Final Production Tests (Chart II)

None.

4.2.3 Deviations from Burn-in and Electrical Measurements (Chart III)

None.

4.2.4 Deviations from Qualification Tests (Chart IV)

None.

4.2.5 Deviations from Lot Acceptance Tests (Chart V)

None.

4.3 MECHANICAL REQUIREMENTS

4.3.1 Dimension Check

The dimensions of the resistors specified herein shall be checked. They shall conform to those shown in Figure 2 of this specification.



4.3.2 Weight

The maximum weight of the resistors specified herein shall be 3.3 grammes.

4.3.3 Robustness of Terminations

The requirements for robustness of termination testing are specified in Section 9 of ESA/SCC Generic Specification No. 4003. The test conditions shall be as follows:-

Applied Force: 20 N.

Duration: 5 to 10 seconds.

4.4 MATERIALS AND FINISHES

The materials and finishes shall be as specified herein. Where a definite material is not specified, a material which will enable the resistors specified herein to meet the performance requirements of this specification shall be used. Acceptance or approval of any constituent material does not guarantee acceptance of the finished product.

4.4.1 Housing

The housing shall be made from an aluminium alloy and shall be protected against corrosion. All fasteners shall be suitably plated.

4.4.2 Terminals

Connection of the resistor windings to terminals shall result in a joint that is electrically stable and mechanically strong. Terminals shall be suitably treated to facilitate soldering. When a coating containing tin is used, the tin content shall range between 40 and 70%. The terminals shall be firmly secured and shall not be solely dependent on the protective coating or enclosure for mechanical anchorage.

4.4.3 Wire

Each resistor shall be wound with a conductor having no joints, welds or bonds within each terminated resistance element, except at the end terminals. In no case shall the nominal diameter be less than 25µm. For wires with a nominal diameter of less than 60µm, no abrasion, with the view of achieving the required resistance tolerance, is allowed. For diameters equal to or greater than that above, the abrasion, if performed, must be evenly distributed around the resistor body. The remaining cross-sectional area of the wire after the abrading operation shall be at least 90% of the original cross-sectional area.



4.5 MARKING

4.5.1 General

The marking of all components delivered to this specification shall be in accordance with the requirements of ESA/SCC Basic Specification No. 21700 and the following paragraphs.

Each component shall be marked in respect of:-

- (a) The SCC Component Number.
- (b) Electrical Characteristics and Ratings.
- (c) Traceability Information.

4.5.2 The SCC Component Number

The SCC Component Number shall be constituted and marked as follows:

Detail Specification Number _____ 4003004B
Testing Level (B or C, as appropriate) _____

4.5.3 Electrical Characteristics and Ratings

The electrical characteristics and ratings to be marked in the following order of precedence are:-

- (a) Numerical Value.
- (b) Tolerance.
- (c) Temperature Coefficient.

The information shall be constituted and marked as follows:

Value (2.55 Ohms) _____ 2R55F3
Tolerance _____
Temperature Coefficient _____

4.5.3.1 Numerical Values

Numerical values shall be expressed by means of the following codes. The unit quantity for marking shall be ohms.

Resistance Value	Code
0.0XX	R0XX
0.XXX	RXXX
X.XX	XRXX
XX.X	XXRX
XXX	XXX0
XXX10 ¹	XXX1

For values of 100 and above, the first 3 digits (X) represent significant figures and the last digit specifies the number of zeros to follow.

When values of less than 100 are required, the letter 'R' is used to indicate the decimal point. When the letter is used, all successive digits represent significant figures.

4.5.3.2 Tolerance

The tolerance on numerical values shall be indicated by the letter codes specified hereafter:-

Tolerance (%)	Code Letter
± 1.0	F
± 2.0	G
± 5.0	J
± 10	K

4.5.3.3 Temperature Coefficient

The temperature coefficients shall be indicated by the numerical codes specified hereafter:-

Digit	Temperature Coefficient (\pm ppm/ $^{\circ}$ C)
9	30
3	50
4	100

4.5.4 Traceability Information

Traceability information shall be marked in accordance with the requirements of ESA/SCC Basic Specification No. 21700.

4.5.5 Marking of Small Components

Where it is considered that a component is too small to accommodate the marking as specified above, as much as space permits shall be marked. The order of precedence shall be as specified in Para. 4.5.1. The marking information in full shall accompany each component in its primary package.

4.6 ELECTRICAL MEASUREMENTS

4.6.1 Electrical Measurements at Room Temperature

The parameters to be measured at room temperature are scheduled in Table 2. The measurements shall be performed at $T_{amb} = +22 \pm 3$ $^{\circ}$ C.

4.6.2 Electrical Measurements at High and Low Temperatures

The parameters to be measured on a sample basis at high and low temperatures are scheduled in Table 3. AQL shall be 2.5% out of the total production lot.

The distribution of the sample shall be as follows:

- 1/3 with the lowest resistance value,
- 1/3 with the highest resistance value,
- 1/3 with the median resistance value.

4.6.3 Circuits for Electrical Measurements (Figure 4)

Not applicable.

TABLE 2 - ELECTRICAL MEASUREMENTS AT ROOM TEMPERATURE

No.	Characteristics	Symbol	Spec. and/or Test Method	Test Conditions	Tolerance (%)	Limits		Unit
						Min.	Max.	
1	Resistance	R_A	ESA/SCC Gen. Spec. No. 4003	Para. 9.5	± 1.0	$0.99 R_n$	$1.01 R_n$	Ω
					± 2.0	$0.98 R_n$	$1.02 R_n$	
					± 5.0	$0.95 R_n$	$1.05 R_n$	
					± 10	$0.90 R_n$	$1.10 R_n$	
2	Insulation Resistance	R_i	ESA/SCC Gen. Spec. No. 4003	Para. 9.6 Note 1	All	1 000	-	$M\Omega$
3(a)	Voltage Proof	U_{proof}	ESA/SCC Gen. Spec. No. 4003	Para. 9.8 for atm. pressure	All	1 000	-	Vrms
3(b)				Para. 9.8 for reduced pressure Notes 1 & 2	All	500	-	
4	Maximum Time Constant due to Reactance of Resistor (Note 1)	L/R	ESA/SCC Gen. Spec. No. 4003	Para. 9.18 and Figs. 4(a) & 4(b) of this spec.	All	30	-	ns

NOTES

1. Measurements on a sample basis; sample size as specified in Para. 4.6.2.
2. The pressure shall be 8.0mm of mercury (equivalent to an altitude of 30480 metres).

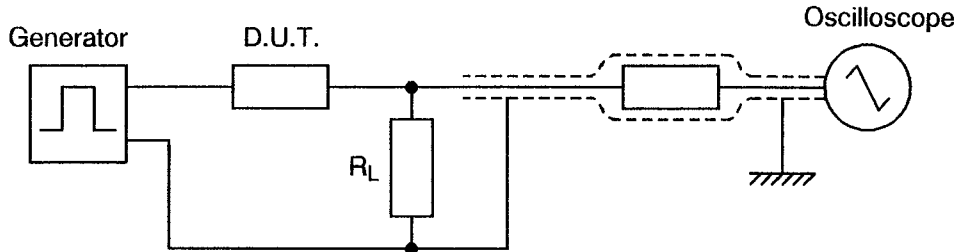

TABLE 3 - ELECTRICAL MEASUREMENTS AT HIGH AND LOW TEMPERATURES

No.	Characteristics	Symbol	Spec. and/or Test Method	Test Conditions	Resistance Range (Ω)	Limits		Unit
						Min.	Max.	
1	Resistance Change between $-55(+3-0)^{\circ}\text{C}$ and $+22\pm 3^{\circ}\text{C}$	$\frac{\Delta R}{R}$	ESA/SCC Gen. Spec. No. 4003	Para. 9.5	$R_n \leq 0.1$	-0.8	+0.8	%
					$0.1 < R_n < 2000$	-0.4	+0.4	
					$R_n > 2000$	-0.25	+0.25	
2	Resistance Change between $+175(+0-3)^{\circ}\text{C}$ and $+22\pm 3^{\circ}\text{C}$	$\frac{\Delta R}{R}$	ESA/SCC Gen. Spec. No. 4003	Para. 9.5	$R_n \leq 0.1$	-1.5	+1.5	%
					$0.1 < R_n < 2000$	-0.75	+0.75	
					$R_n > 2000$	-0.4	+0.4	



FIGURE 4(a) - TEST CIRCUIT FOR REACTANCE MEASUREMENT



D.U.T. = Resistor Under Test.

R_L = Non-inductive resistor with resistance approximately equal to 0.1 times the resistance of the D.U.T.

The length of the connecting leads between generator and resistor shall not exceed 5.0cm.

Pulse Generator Specification

Voltage < 5.0V, Output Impedance = 50Ω.

Pulse width larger than 100ns.

Rise time on load (10 to 90%): less than 18ns.

Repetition rate: greater than 10kHz or sufficient for good oscilloscope readability.

Oscilloscope Specification



Rise time (10 to 80%): less than 12ns.

Time base: 20ns per cm or faster.

Maximum input capacitance at R_L should be 25pF. With this equipment, the L/R time constant can be measured. This is done by measuring the time between the start of the pulse and the time the voltage attains 63.2% of the maximum. If there is noise distortion at the start of the rise, the zero point can be determined by extension of the curve.

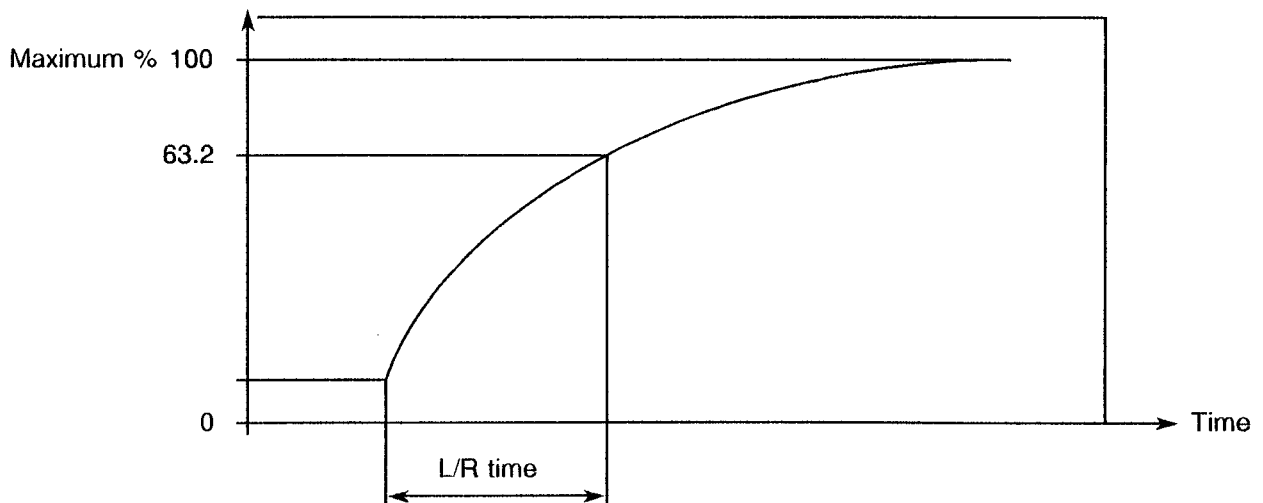
FIGURE 4(b) - OSCILLOSCOPE TRACE



 	<p style="text-align: center;">ESA/SCC Detail Specification No. 4003/004</p>	<p style="text-align: center;">Rev. 'A'</p>	<p style="text-align: center;">PAGE 18 ISSUE 2</p>
---	--	---	--

4.7 BURN-IN TESTS

4.7.1 Parameter Drift Values

The parameter drift values applicable to burn-in are specified in Table 4 of this specification. Unless otherwise stated, measurements shall be performed at $T_{amb} = +22 \pm 3$ °C. The parameter drift values (Δ) applicable to the parameters scheduled, shall not be exceeded. In addition to these drift value requirements, the appropriate limit value specified in Table 2 for a given parameter shall not be exceeded.

4.7.2 Conditions for Burn-in

The requirements for burn-in are specified in Section 7 of ESA/SCC Generic Specification No. 4003. The conditions for burn-in shall be as specified in Table 5(a) of this specification.

The resistors shall be tested with a d.c. voltage with a ripple does not exceed 5.0%.

A voltage of $\sqrt{4 R_n}$ (see Figure 5) shall be applied in cycles of 90 minutes "on" and 30 minutes "off" throughout the test.

The resistors shall be connected by their terminations to suitable clips on a rack of insulating material. They shall be so arranged that the temperature of any one resistor does not appreciably influence the temperature of any other resistor. There shall be no undue draught over the resistors. After the period specified in the Generic Specification, the resistors shall be removed from the chamber and allowed to cool under normal atmospheric conditions for a minimum of 4 hours.

4.7.3 Electrical Circuits for Burn-in

The circuit for use in performing the burn-in test is shown in Figure 5 of this specification.

4.8 ENVIRONMENTAL AND ENDURANCE TESTS (CHARTS IV AND V OF ESA/SCC GENERIC SPECIFICATION No. 4003)

4.8.1 Electrical Measurements on Completion of Environmental Tests

The parameters to be measured on completion of environmental tests are scheduled in Table 6. Unless otherwise stated, the measurements shall be performed at $T_{amb} = +22 \pm 3$ °C.

4.8.2 Electrical Measurements at Intermediate Points during Endurance Tests

The parameters to be measured at intermediate points during endurance tests are as scheduled in Table 6 of this specification.

TABLE 4 - PARAMETER DRIFT VALUES

Characteristics	Symbol	Specification	Test Conditions	Change Limits (Δ)	Unit
Resistance	$\frac{\Delta R}{R}$	ESA/SCC Gen. Spec. No. 4003	Para. 9.5	± 0.3 (Note 1)	%

NOTES

1. Or $\Delta R = \pm 0.05\Omega$, whichever is greater.

TABLE 5(a) - CONDITIONS FOR BURN-IN TESTS

No.	Characteristics	Symbol	Condition	Unit
1	Temperature for Initial Measurement	T_{amb}	$+ 22 \pm 3$	$^{\circ}C$
2	Temperature for Burn-in Tests	T_{amb}	$+ 25 \pm 10$	$^{\circ}C$
3	Voltage Applied	U_T	$\sqrt{4 R_n}$	Vdc or Vrms
4	Temperature for Final Measurement	T_{amb}	$+ 22 \pm 3$	$^{\circ}C$

TABLE 5(b) - CONDITIONS FOR OPERATING LIFE TESTS

No.	Characteristics	Symbol	Condition	Unit
1	Temperature for Initial Measurement	T_{amb}	$+ 22 \pm 3$	$^{\circ}C$
2	Temperature for Operating Life Tests	T_{amb}	$+ 25 \pm 10$	$^{\circ}C$
3	Voltage Applied	U_T	$\sqrt{5 R_n}$	Vdc or Vrms
4	Temperature for Final Measurement	T_{amb}	$+ 22 \pm 3$	$^{\circ}C$

FIGURE 5 - CIRCUIT FOR BURN-IN AND OPERATING LIFE TESTS

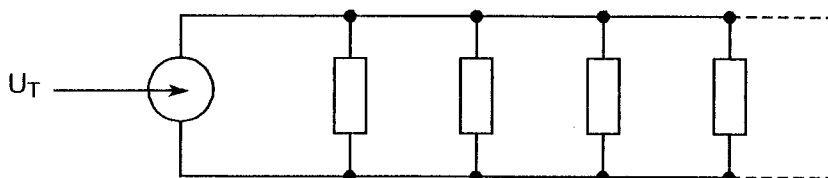



SCC

ESA/SCC Detail Specification
No. 4003/004

Rev. 'B'

PAGE 20

ISSUE 2

TABLE 6 - MEASUREMENTS AND INSPECTIONS ON COMPLETION OF ENVIRONMENTAL TESTS AND AT INTERMEDIATE POINTS AND ON COMPLETION OF ENDURANCE TESTING

NO.	ESA/SCC GENERIC SPEC. No. 4003		MEASUREMENTS AND INSPECTIONS		SYMBOL	LIMITS		UNIT
	ENVIRONMENTAL AND ENDURANCE TESTS (1)	TEST METHOD AND CONDITIONS	IDENTIFICATION	CONDITIONS		MIN.	MAX.	
01	Overload	Para. 9.1 and Table 1(b) of this specification	Initial Measurements Resistance Final Measurements Visual Examination Resistance Change	Table 2 Item 1 After 1 to 2 hrs recovery No damage Legible marking Table 2 Item 1	R_A - $\Delta R_A/R_A$	Table 2 Item 1 - $\pm (0.3\% + 0.05\Omega)$	- - Ω	
02	Permanence of Marking	Para. 9.6	Final Measurements Visual Examination	No corrosion or obliteration of marking	-	-	-	
03	Temperature Characteristic of Resistance	Para. 9.7 Procedure II	During Test Temperature Characteristic of Resistance	Para. 9.7.3 of ESA/SCC No. 4003	TCR	Table 1(a)	ppm/°C	
04	Voltage Proof (Altitude)	Para. 9.8 and Table 1(b) of this spec. 500Vrms	Initial Measurements Resistance During Test Visual Examination Final Measurements Resistance Change	Table 2 Item 1 At Reduced Pressure 8mm Mercury No Breakdown or Flashover Table 2 Item 1	R_A - $\Delta R_A/R_A$	Table 2 Item 1 - $\pm (0.2\% + 0.05\Omega)$	- - Ω	
05	Solderability	Para. 9.9 Procedure II	Final Measurements Visual Examination	No damage Legible marking	-	-	-	
06	Robustness of Terminations	Para. 9.10 and Para. 4.3.3 of this specification	Initial Measurements Resistance Final Measurements Visual Examination Resistance Change	Table 2 Item 1 No damage Table 2 Item 1	R_A - $\Delta R_A/R_A$	Table 2 Item 1 - $\pm (0.2\% + 0.05\Omega)$	- - Ω	
07	Resistance to Soldering Heat	Para. 9.11 Procedure I	Initial Measurements Resistance Final Measurements Visual Examination Resistance Change	Table 2 Item 1 After 24 ± 4 hours recovery No damage Legible marking Table 2 Item 1	R_A - $\Delta R_A/R_A$	Table 2 Item 1 - $\pm (0.3\% + 0.05\Omega)$	- - Ω	
08	Rapid Change of Temperature	Para. 9.12 and Table 1(b) of this spec.	Initial Measurements Resistance Final Measurements Visual Examination Resistance Change	Table 2 Item 1 After 1 to 2 hrs recovery No damage Table 2 Item 1	R_A - $\Delta R_A/R_A$	Table 2 Item 1 - $\pm (0.5\% + 0.05\Omega)$	- - Ω	
09	Vibration	Para. 9.13	Initial Measurements Resistance Final Measurements Visual Examination Resistance Change	Table 2 Item 1 No damage Table 2 Item 1	R_A - $\Delta R_A/R_A$	Table 2 Item 1 - $\pm (0.2\% + 0.05\Omega)$	- - Ω	

NOTES

1. The tests in this Table refer to either Chart IV or V and shall be used as applicable.



SCC

ESA/SCC Detail Specification
No. 4003/004

Rev. 'B'

PAGE 20A

ISSUE 2

TABLE 6 - MEASUREMENTS AND INSPECTIONS ON COMPLETION OF ENVIRONMENTAL TESTS AND AT INTERMEDIATE POINTS AND ON COMPLETION OF ENDURANCE TESTING (CONT'D)

NO.	ESA/SCC GENERIC SPEC. NO. 4003		MEASUREMENTS AND INSPECTIONS		SYMBOL	LIMITS		UNIT
	ENVIRONMENTAL AND ENDURANCE TESTS (1)	TEST METHOD AND CONDITIONS	IDENTIFICATION	CONDITIONS		MIN.	MAX.	
10	Climatic Sequence	Para. 9.14 Procedure I	Initial Measurements Resistance Final Measurements Resistance Change Insulation Resistance	After Drying Table 2 Item 1 After 1 to 2 hrs recovery Table 2 Item 1 Table 2 Item 2	R_A $\Delta R_A/R_A$ R_i	Table 2 Item 1 $\pm (1.0\% + 0.01\Omega)$ 1000	- -	Ω $M\Omega$
11	Operating Life	Para. 9.15 Chart IV	Initial Measurements Resistance Intermediate Measurements Resistance Change Final Measurements Resistance Change	Table 2 Item 1 1000 ± 48 hrs After 1 to 2 hrs recovery Table 2 Item 1 2000 ± 48 hrs After 1 to 2 hrs recovery Table 2 Item 1	R_A $\Delta R_A/R_A$ $\Delta R_A/R_A$	Table 2 Item 1 $\pm (0.8\% + 0.05\Omega)$ $\pm (1.0\% + 0.05\Omega)$	- -	Ω Ω
		Para. 9.15 Chart V	Initial Measurements Resistance Final Measurements Resistance Change	Table 2 Item 1 1000 ± 48 hrs After 1 to 2 hrs recovery Table 2 Item 1	R_A $\Delta R_A/R_A$	Table 2 Item 1 $\pm (0.8\% + 0.05\Omega)$	- -	Ω Ω
12	High Temperature Storage	Para. 9.16	Initial Measurements Resistance	Table 2 Item 1 1000 ± 48 hrs	R_A	Table 2 Item 1	-	-
			Intermediate Measurements Resistance Change	Table 2 Item 1 2000 ± 48 hrs	$\Delta R_A/R_A$	$\pm (0.8\% + 0.05\Omega)$	-	Ω
			Final Measurements Resistance Change	Table 2 Item 1	$\Delta R_A/R_A$	$\pm (1.0\% + 0.05\Omega)$	-	Ω
13	External Visual Inspection	Para. 9.17	Visual Inspection	ESA/SCC No. 20500	-	-	-	-
14	Maximum Time Constant (Not applicable to inductive resistors)	Para. 9.18	Time Constant	Table 2 Item 4	L/R	Table 2 Item 4	-	-

NOTES: See Page 20.



4.8.3 Electrical Measurements on Completion of Endurance Tests

The parameters to be measured on completion of endurance testing are as scheduled in Table 6 of this specification. Unless otherwise stated, the measurements shall be performed at $T_{amb} = +22 \pm 3 \text{ } ^\circ\text{C}$.

4.8.4 Conditions for Operating Life Tests (Part of Endurance Testing)

The requirements for operating life testing are specified in Section 9 of ESA/SCC Generic Specification No. 4003. The conditions for operating life testing shall be as specified in Table 5(b).

Resistors shall be centrally mounted by normal mounting means on an aluminium chassis of thickness 1.0mm, length 153mm, width 102mm and height 51mm. The longitudinal axis of the resistor shall be parallel to the longitudinal axis of the chassis.

4.8.5 Electrical Circuits for Operating Life Tests

The electrical circuit for use in performing the operating life tests is shown in Figure 5 of this specification.

4.8.6 Conditions for High Temperature Storage Test (Part of Endurance Testing)

The requirements for the high temperature storage test are specified in Section 9 of ESA/SCC Generic Specification No. 4003. The conditions for high temperature storage shall be $T_{amb} = +275(+0 - 5) \text{ } ^\circ\text{C}$.