



europaean space agency
agence spatiale européenne

Pages 1 to 20





TRANSISTORS, LOW POWER, NPN,

BASED ON TYPE 2N2369A

ESA/SCC Detail Specification No. 5201/006

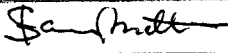
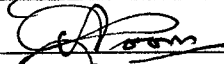
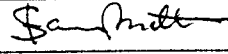

**space components
coordination group**

Issue/Rev.	Date	Approved by	
		SCCG Chairman	ESA Director General or his Deputy
Issue 3	August 1996		
Revision 'A'	April 1997		
Revision 'B'	June 1999		

**DOCUMENTATION CHANGE NOTICE**

Rev. Letter	Rev. Date	Reference	CHANGE Item	Approved DCR No.
		This Issue supersedes Issue 2 and incorporates all modifications defined in Revisions 'A', 'B', 'C', 'D', 'E' and 'F' to Issue 2 and the changes agreed in the following DCR's:-		
		Cover page	: Part Number corrected	221357
		DCN		None
		Para. 1.2	: Existing text deleted and new text added	221357
		Para. 2	: Item (c) deleted	221357
		Table 1(a)	: Lead Material column heading amended	221357
			: Figure numbers amended	221357
			: Variant 04 added	221357
		Table 1(b)	: Nos. 1 to 3, "Breakdown" deleted from Characteristics	221357
			: No. 5, "1" added to Characteristics and Symbol	221357
			, "(See Figure 1)" deleted from Characteristics, Variant references added	221357
			, New Maximum Rating added and Unit added	221357
			, Remarks amended and "Note 2" added	221357
			: No. 6, "2" added to Characteristics and Symbol	221357
			, "Variants 01 to 03" added to Characteristics	221357
			, Remarks amended and "Note 2" added	221357
			: No. 7, Symbol amended to "T _{op} " and "T _{amb} " added to Remarks	221357
			: No. 9, Variants added to Characteristics	221357
			, "+ 245" added to Maximum Ratings	221357
			, Existing Remarks deleted and Note references added	221357
			: NOTES, Notes 1 to 4 added	221357
		Figure 2	: Existing Figure Titled as Figure 2(a)	221357
			: Imperial Dimensions deleted from Table and Notes	221357
		Figure 2(b)	: New Figure added	221357
		Figure 3	: Note amended	221357
		Para. 4.3.2	: Text amended	221357
		Para. 4.3.3	: Second sentence amended	221357
			: Applied Force and Duration deleted	221332
		Para. 4.4.1	: Existing text deleted and new text added	221357
		Para. 4.4.2	: Existing text amended and new text added	221357
		Para. 4.5.1	: Existing text deleted and new text added	221357
		Para. 4.5.5	: Deleted in toto	221357
		Para. 4.7.2	: New paragraph added	221357
			: Existing paragraph renumbered to "4.7.3" and second sentence amended	221357
		Para. 4.7.3	: Renumbered as "4.7.5" and text amended	221357
		Para. 4.7.4	: New paragraph added	221357
		Table 5(a)	: Entry added	221357
		Table 5	: Renumbered as "5(b)" and Title amended	221357
			: No. 2, "1" added to Characteristics and Symbol	221357
			, "Note 1" added to Conditions	221357
			: Note 1 added	221357
		Figure 5(a)	: Entry added	221357
		Figure 5	: Renumbered as "5(b)" and Title amended	221357



DOCUMENTATION CHANGE NOTICE

Rev. Letter	Rev. Date	Reference	CHANGE Item	Approved DCR No.
		Para. 4.8.1 Para. 4.8.2 Paras 4.8.3 and 4.8.4 Para. 4.8.5	: Second sentence expanded : Second sentence added : In the text, "5" amended to "5(b)" : In second sentence, "1" amended to "1(b)"	221357 221357 221357 221357
'A'	Apr. '97	P1. Cover page P2A. DCN P4. T of C P20. Appendix 'B'	: Page count incremented by 1 : Under Appendices, Appendix 'B' added : Appendix added as new page	221367 None 221367 221367
'B'	Jun. '99	P1. Cover page P2A. DCN P6. Table 1(a) Table 1(b) P9. Figure 2(b) P10. Para. 4.3.2 P11. Para. 4.4.1 Para. 4.4.2	: New Variant 05 added in the Table : Items 5 and 9, in Characteristics, "Variant 04" amended to "Variants 04 and 05" : Subtitle amended to " Variants 04 and 05" : Text amended : Second sentence amended to include Variant 05 : Second sentence amended to include Variant 05	None None 221518 221518 221518 221518 221518 221518

**SCC**ESA/SCC Detail Specification
No. 5201/006

PAGE 3

ISSUE 3

TABLE OF CONTENTS

	<u>Page</u>
1. <u>GENERAL</u>	5
1.1 Scope	5
1.2 Component Type Variants	5
1.3 Maximum Ratings	5
1.4 Parameter Derating Information	5
1.5 Physical Dimensions	5
1.6 Functional Diagram	5
1.7 High Temperature Test Precautions	5
2. <u>APPLICABLE DOCUMENTS</u>	5
3. <u>TERMS, DEFINITIONS, ABBREVIATIONS, SYMBOLS AND UNITS</u>	5
4. <u>REQUIREMENTS</u>	10
4.1 General	10
4.2 Deviations from Generic Specification	10
4.2.1 Deviations from Special In-process Controls	10
4.2.2 Deviations from Final Production Tests	10
4.2.3 Deviations from Burn-in and Electrical Measurements	10
4.2.4 Deviations from Qualification Tests	10
4.2.5 Deviations from Lot Acceptance Tests	10
4.3 Mechanical Requirements	10
4.3.1 Dimension Check	10
4.3.2 Weight	10
4.3.3 Terminal Strength	11
4.4 Materials and Finishes	11
4.4.1 Case	11
4.4.2 Lead Material and Finish	11
4.5 Marking	11
4.5.1 General	11
4.5.2 Lead Identification	11
4.5.3 The SCC Component Number	12
4.5.4 Traceability Information	12
4.6 Electrical Measurements	12
4.6.1 Electrical Measurements at Room Temperature	12
4.6.2 Electrical Measurements at High and Low Temperatures	12
4.6.3 Circuits for Electrical Measurements	12
4.7 Burn-in Tests	12
4.7.1 Parameter Drift Values	12
4.7.2 Conditions for High Temperature Reverse Bias Burn-in	12
4.7.3 Conditions for Power Burn-in	12
4.7.4 Electrical Circuits for High Temperature Reverse Bias Burn-in	12
4.7.5 Electrical Circuits for Power Burn-in	12
4.8 Environmental and Endurance Tests	17
4.8.1 Electrical Measurements on Completion of Environmental Tests	17
4.8.2 Electrical Measurements at Intermediate Points and on Completion of Endurance Tests	17
4.8.3 Conditions for Operating Life Tests	17
4.8.4 Electrical Circuits for Operating Life Tests	17
4.8.5 Conditions for High Temperature Storage Test	17



TABLES



	<u>Page</u>
1(a) Type Variants	6
1(b) Maximum Ratings	6
2 Electrical Measurements at Room Temperature - d.c. Parameters	13
Electrical Measurements at Room Temperature - a.c. Parameters	14
3 Electrical Measurements at High and Low Temperatures	14
4 Parameter Drift Values	16
5(a) Conditions for High Temperature Reverse Bias Burn-in	16
5(b) Conditions for Power Burn-in and Operating Life Tests	16
6 Electrical Measurements at Intermediate Points and on Completion of Endurance Testing	18

FIGURES

1 Parameter Derating Information	7
2 Physical Dimensions	8
3 Functional Diagram	9
4 Circuits for Electrical Measurements	15
5(a) Electrical Circuit for High Temperature Reverse Bias Burn-in	16
5(b) Electrical Circuit for Power Burn-in and Operating Life Tests	16

APPENDICES (Applicable to specific Manufacturers only)

'A' Agreed Deviations for SGS ATEs (I)	19
'B' Agreed Deviations for SGS-Thomson (F)	20

 	ESA/SCC Detail Specification No. 5201/006		PAGE 5 ISSUE 3
--------------------------------------------------------------------------------------------------------------------------------------------------------------------	----------------------------------------------	--	-------------------

1. **GENERAL**

1.1 **SCOPE**

This specification details the ratings, physical and electrical characteristics, test and inspection data for Transistors, Low Power, NPN, based on Type 2N2369A. It shall be read in conjunction with ESA/SCC Generic Specification No. 5000, the requirements of which are supplemented herein.

1.2 **COMPONENT TYPE VARIANTS**

Variants of the basic transistors specified herein, which are also covered by this specification, are given in Table 1(a).

1.3 **MAXIMUM RATINGS**

The maximum ratings, which shall not be exceeded at any time during use or storage, applicable to the transistors specified herein, are scheduled in Table 1(b).

1.4 **PARAMETER DERATING INFORMATION**

The derating information applicable to the transistors specified herein is shown in Figure 1.

1.5 **PHYSICAL DIMENSIONS**

The physical dimensions of the transistors specified herein are shown in Figure 2.

1.6 **FUNCTIONAL DIAGRAM**

The functional diagram, showing lead identification, of the transistors specified herein, is shown in Figure 3.

1.7 **HIGH TEMPERATURE TEST PRECAUTIONS**

For tin-lead plated or solder-dipped lead finish, all tests to be performed at a temperature that exceeds + 125°C shall be carried out in 100% inert atmosphere.

2. **APPLICABLE DOCUMENTS**

The following documents form part of this specification and shall be read in conjunction with it:-

- (a) ESA/SCC Generic Specification No. 5000 for Discrete Semiconductors.
- (b) MIL-STD-750, Test Methods and Procedures for Semiconductor Devices.

3. **TERMS, DEFINITIONS, ABBREVIATIONS, SYMBOLS AND UNITS**

For the purpose of this specification, the terms, definitions, abbreviations, symbols and units specified in ESA/SCC Basic Specification No. 21300 shall apply.



 	ESA/SCC Detail Specification No. 5201/006	Rev. 'B'	PAGE 6
			ISSUE 3

TABLE 1(a) - TYPE VARIANTS

VARIANT	BASED ON TYPE	CASE	FIGURE	LEAD MATERIAL AND/OR FINISH
01	2N2369A	TO18	2(a)	D2
02	2N2369A	TO18	2(a)	D3 or D4
03	2N2369A	TO18	2(a)	D7
04	2N2369A	CHIP CARRIER	2(b)	2
05	2N2369A	CHIP CARRIER	2(b)	4

TABLE 1(b) - MAXIMUM RATINGS

No.	CHARACTERISTICS	SYMBOL	MAXIMUM RATING	UNIT	REMARKS
1	Collector-Base Voltage	V_{CBO}	40	V	Over entire operating temperature range
2	Collector-Emitter Voltage	V_{CEO}	15	V	
3	Emitter-Base Voltage	V_{EBO}	4.5	V	
4	Collector Current	I_C	500	mA	10 μ s pulse
5	Power Dissipation 1 All Variants Variants 04 and 05	P_{tot1}	0.36 0.58 (1)	W	At $T_{amb} \leq +25^\circ\text{C}$ Note 2
6	Power Dissipation 2 Variants 01 to 03	P_{tot2}	1.2	W	At $T_{case} \leq +25^\circ\text{C}$ Note 2
7	Operating Temperature Range	T_{op}	- 65 to + 200	$^\circ\text{C}$	T_{amb}
8	Storage Temperature Range	T_{stg}	- 65 to + 200	$^\circ\text{C}$	
9	Soldering Temperature Variants 01 to 03 Variants 04 and 05	T_{sol}	+ 260 + 245	$^\circ\text{C}$	Note 3 Note 4

NOTES

1. When mounted on a 15×15×0.6mm ceramic substrate.
2. For derating at T_{amb} or $T_{case} > +25^\circ\text{C}$, see Figure 1.
3. Duration 10 seconds maximum at a distance of not less than 1.5mm from the device body and the same lead shall not be resoldered until 3 minutes have elapsed.
4. Duration 5 seconds maximum and the same terminal shall not be resoldered until 3 minutes have elapsed.



FIGURE 1 - PARAMETER DERATING INFORMATION

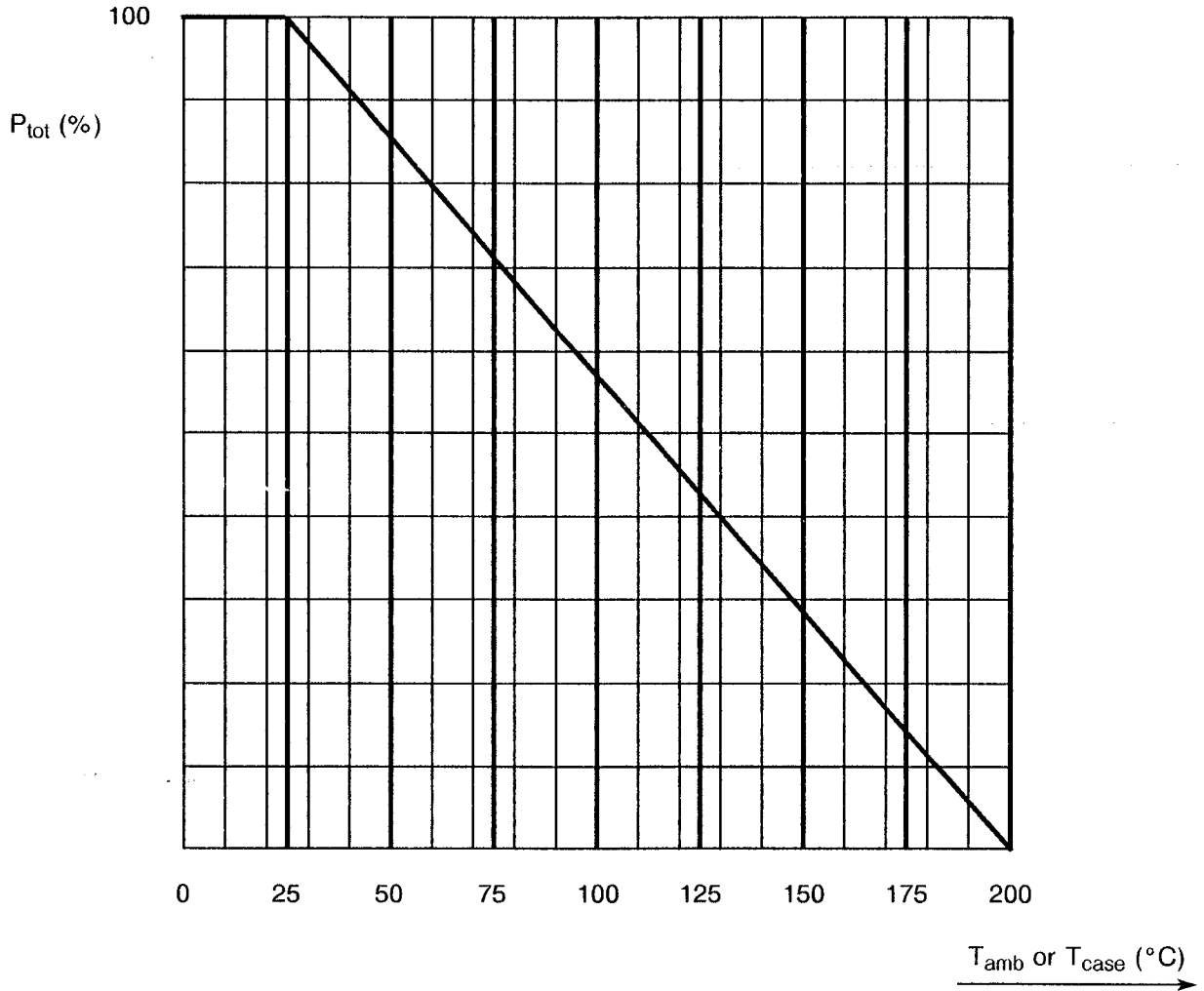

Power Dissipation versus Temperature



FIGURE 2 - PHYSICAL DIMENSIONS

FIGURE 2(a) - VARIANTS 01 TO 03

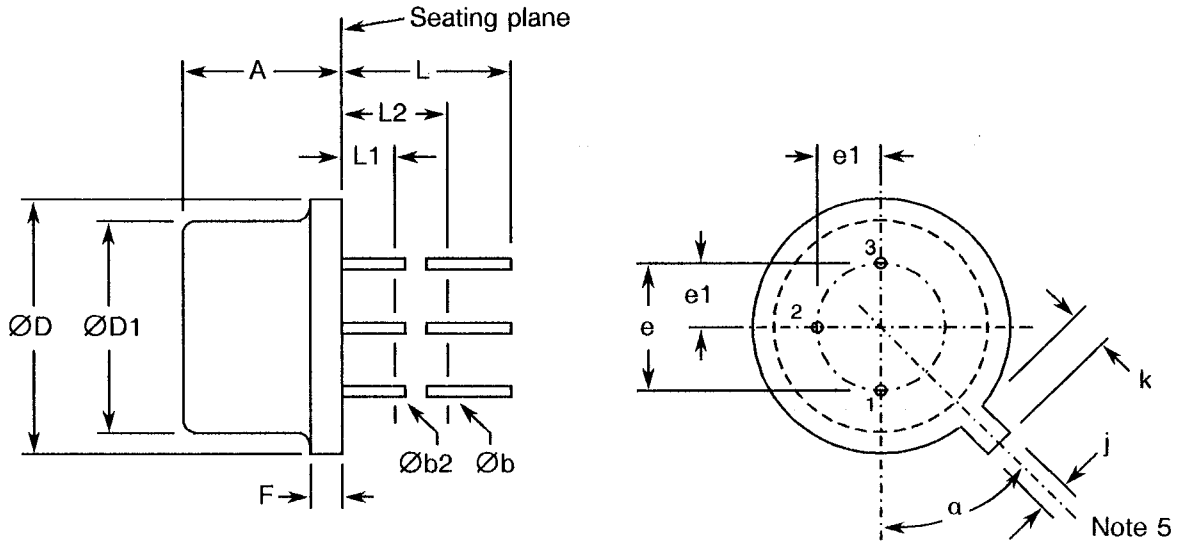

SYMBOL	MILLIMETRES		NOTES
	MIN.	MAX	
A	4.32	5.33	
Øb	0.406	0.533	1
Øb2	0.406	0.483	1
ØD	5.31	5.84	
ØD1	4.52	4.95	
e	2.54 TYP.		2, 4
e1	1.27 TYP.		2, 4
F	-	0.762	
j	0.914	1.17	4
k	0.711	1.22	3
L	12.70	-	1
L1	-	1.27	1
L2	6.35	-	1
a	45° TYP.		5

NOTES

1. (Three leads) Øb2 applies between L1 and L2. Øb applies between L2 and 12.70mm from the seating plane. Diameter is uncontrolled in L1 and beyond 12.70mm from the seating plane.
2. Leads having maximum diameter 0.483mm measured in the gauging plane 1.37mm + 0.025mm - 0.00mm below the seating plane of the device shall be within 0.178mm of their true position relative to a maximum-width-tab.
3. Measured from maximum diameter of the actual device.
4. The device may be measured by direct methods or by the gauge and gauging procedure described on gauge drawing GS-2.
5. Tab centreline.

FIGURE 2 - PHYSICAL DIMENSIONS (CONTINUED)

FIGURE 2(b) - VARIANTS 04 AND 05

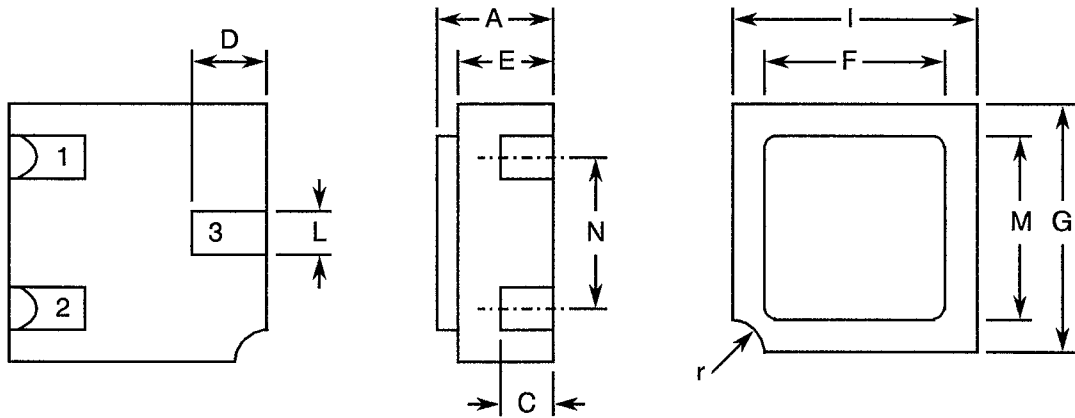

SYMBOL	MILLIMETRES		NOTES
	MIN.	MAX	
A	1.15	1.50	
C	0.45	0.56	1
D	0.60	0.91	1
E	0.91	1.12	
F	1.90	2.15	
G	2.90	3.25	
I	2.40	2.85	
L	0.40	0.60	1
M	2.40	2.65	
N	1.80	2.00	
r	0.3 TYP.		

NOTES

1. The three pads have the same dimensions.

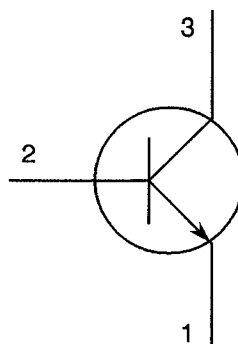

FIGURE 3 - FUNCTIONAL DIAGRAM



1. Emitter.
2. Base.
3. Collector.

NOTES

1. For Variants 01 to 03, the collector is internally connected to the case.

 	<p style="text-align: center;">ESA/SCC Detail Specification No. 5201/006</p>	<p style="text-align: center;">Rev. 'B'</p>	<p style="text-align: right;">PAGE 10 ISSUE 3</p>
---------------------------------------------------------------------------------------------------------------------------------------------------------------------	----------------------------------------------------------------------------------	---------------------------------------------	-------------------------------------------------------

4. REQUIREMENTS

4.1 GENERAL

The complete requirements for procurement of the transistors specified herein shall be as stated in this specification and ESA/SCC Generic Specification No. 5000 for Discrete Semiconductors. Deviations from the Generic Specification, applicable to this specification only, are listed in Para. 4.2.

Deviations from the applicable Generic Specification and this Detail Specification, formally agreed with specific Manufacturers on the basis that the alternative requirements are equivalent to the ESA/SCC requirements and do not affect the components' reliability, are listed in the appendices attached to this specification.

4.2 DEVIATIONS FROM GENERIC SPECIFICATION

4.2.1 Deviations from Special In-process Controls

None.

4.2.2 Deviations from Final Production Tests (Chart II)

None.

4.2.3 Deviations from Burn-in and Electrical Measurements (Chart III)

(a) Para. 7.1.1(a), High Temperature Reverse Bias Burn-in and subsequent electrical measurements related to this test shall be omitted.

4.2.4 Deviations from Qualification Tests (Chart IV)

None.

4.2.5 Deviations from Lot Acceptance Tests (Chart V)

None.

4.2.5 Deviations from Lot Acceptance Tests (Chart V)

None.

4.3 MECHANICAL REQUIREMENTS

4.3.1 Dimension Check

The dimensions of the transistors specified herein shall be checked. They shall conform to those shown in Figure 2.

4.3.2 Weight

The maximum weight of the transistors specified herein shall be 0.4 grammes for Variants 01 to 03 and 0.06 grammes for Variants 04 and 05.

	<p style="text-align: center;">ESA/SCC Detail Specification No. 5201/006</p>	<p style="text-align: center;">Rev. 'B'</p>	<p style="text-align: right;">PAGE 11 ISSUE 3</p>
-----------------------------------------------------------------------------------	----------------------------------------------------------------------------------	---------------------------------------------	-------------------------------------------------------

4.3.3 Terminal Strength

The requirements for terminal strength testing are specified in Section 9 of ESA/SCC Generic Specification No. 5000. For Variants 01 to 03, the test conditions shall be as follows:-

Test Condition: 'E', Lead Fatigue.

4.4 MATERIALS AND FINISHES

The materials and finishes shall be as specified herein. Where a definite material is not specified, a material which will enable the transistors specified herein to meet the performance requirements of this specification shall be used. Acceptance or approval of any constituent material does not guarantee acceptance of the finished product.

4.4.1 Case

For Variants 01 to 03, the case shall be hermetically sealed and have a metal body with hard glass seals and the lid shall be welded, brazed, preform soldered or glass frit sealed.

For Variants 04 and 05, the case shall be hermetically sealed and have a ceramic body with a kovar lid.

4.4.2 Lead Material and Finish

For Variants 01 to 03, the lead material shall be Type 'D' with either Type '2', Type '3 or 4' or Type '7' finish in accordance with the requirements of ESA/SCC Basic Specification No. 23500. (See Table 1(a) for Type Variants).

For Variants 04 and 05, the terminal finish shall be either Type '2' or Type '4' in accordance with the requirements of ESA/SCC Basic Specification No. 23500. (See Table 1(a) for Type Variants).

4.5 MARKING

4.5.1 General

The marking of all components delivered to this specification shall be in accordance with the requirements of ESA/SCC Basic Specification No. 21700 and the following paragraphs. When the component is too small to accommodate all of the marking specified, as much as space permits shall be marked and the marking information, in full, shall accompany the component in its primary package.

The information to be marked and the order of precedence, shall be as follows:-

- (a) Lead Identification.
- (b) The SCC Component Number.
- (c) Traceability Information.

4.5.2 Lead Identification

Lead identification shall be as shown in Figures 2 and 3.



4.5.3 The SCC Component Number

Each component shall bear the SCC Component Number which shall be constituted and marked as follows:

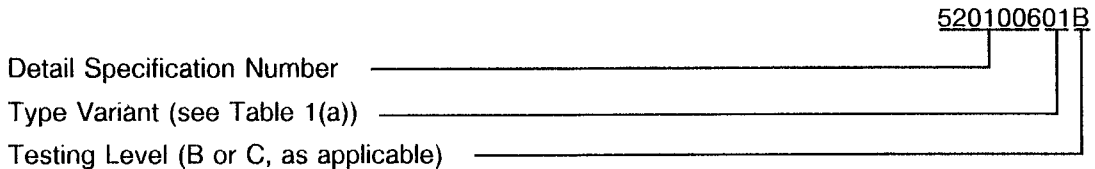

4.5.4 Traceability Information

Each component shall be marked in respect of traceability information in accordance with the requirements of ESA/SCC Basic Specification No. 21700.

4.6 ELECTRICAL MEASUREMENTS

4.6.1 Electrical Measurements at Room Temperature

The parameters to be measured at room temperature are scheduled in Table 2. Unless otherwise specified, the measurements shall be performed at $T_{amb} = +22 \pm 3$ °C.

4.6.2 Electrical Measurements at High and Low Temperatures

The parameters to be measured at high and low temperatures are scheduled in Table 3.

4.6.3 Circuits for Electrical Measurements

Circuits for use in performing the electrical measurements listed in Tables 2 and 3 of this specification are shown in Figure 4.

4.7 BURN-IN TESTS

4.7.1 Parameter Drift Values

The parameter drift values applicable to burn-in are specified in Table 4 of this specification. Unless otherwise stated, the measurements shall be performed at $T_{amb} = +22 \pm 3$ °C. The parameter drift values (Δ) applicable to the parameters scheduled, shall not be exceeded. In addition to these drift value requirements, the appropriate limit value specified for a given parameter in Table 2 shall not be exceeded.

4.7.2 Conditions for High Temperature Reverse Bias Burn-in (Table 5(a))

Not applicable.

4.7.3 Conditions for Power Burn-in

The requirements for power burn-in are specified in Section 7 of ESA/SCC Generic Specification No. 5000. The conditions for power burn-in shall be as specified in Table 5(b) of this specification.

4.7.4 Electrical Circuits for High Temperature Reverse Bias Burn-in (Figure 5(a))

Not applicable.

4.7.5 Electrical Circuits for Power Burn-in

Circuits for use in performing the power burn-in tests are shown in Figure 5(b) of this specification.



TABLE 2 - ELECTRICAL MEASUREMENTS AT ROOM TEMPERATURE - d.c. PARAMETERS

No.	CHARACTERISTICS	SYMBOL	MIL-STD-750 TEST METHOD	TEST CONDITIONS	LIMITS		UNIT
					MIN.	MAX.	
1	Collector-Base Breakdown Voltage	BV_{CBO}	3001	$I_C = 10\mu A$ $I_E = 0A$	40	-	V
2	Collector-Emitter Breakdown Voltage	BV_{CEO}	3011	$I_C = 10mA$, $I_B = 0A$ Note 1	15	-	V
3	Emitter-Base Breakdown Voltage	BV_{EBO}	3026	$I_E = 10\mu A$ $I_C = 0A$	4.5	-	V
4	Collector-Base Cut-off Current	I_{CES}	3041	$V_{CE} = 20V$	-	400	nA
5	Collector-Emitter Saturation Voltage	$V_{CE(SAT)}$	3071	$I_C = 100mA$ $I_B = 10mA$ Note 1	-	0.5	V
6	Base-Emitter Saturation Voltage	$V_{BE(SAT)}$	3071	$I_C = 100mA$ $I_B = 10mA$ Note 1	-	1.6	V
7a	D.C. Forward Current Transfer Ratio 1	h_{FE1}	3076	$V_{CE} = 0.35V$ $I_C = 10mA$ Note 1	40	120	-
7b	D.C. Forward Current Transfer Ratio 2	h_{FE2}	3076	$V_{CE} = 0.4V$ $I_C = 30mA$ Note 1	30	-	-
7c	D.C. Forward Current Transfer Ratio 3	h_{FE3}	3076	$V_{CE} = 1.0V$ $I_C = 100mA$ Note 1	20	-	-

NOTES: See Page 14.

TABLE 2 - ELECTRICAL MEASUREMENTS AT ROOM TEMPERATURE - a.c. PARAMETERS

No.	CHARACTERISTICS	SYMBOL	MIL-STD-750 TEST METHOD	TEST CONDITIONS (NOTE 2)	LIMITS		UNIT
					MIN.	MAX.	
1	Small Signal Current Gain	h_{fe}	3306	$V_{CE} = 10V$ $I_C = 10mA$ $f = 100MHz$	5.0	-	-
2	Output Capacitance	C_{ob}	3236	$V_{CB} = -5.0V$ $I_E = 0A$ $f = 1.0MHz$	-	4.0	pF
3	Turn-on Time	t_{on}	3251.1 Condition B	$I_C = 10mA$ $I_B = 3.0mA$	-	12	ns
4	Turn-off Time	t_{off}	3251.1 Condition B	$I_C = 10mA$ $I_{B1} = 3.0mA$ $I_{B2} = -1.5mA$	-	18	ns

NOTES

1. Pulse measurement: Pulse Length $\leq 300\mu s$, Duty Cycle $\leq 2.0\%$.
2. Performed on a sample basis, LTPD = 7.

TABLE 3 - ELECTRICAL MEASUREMENTS AT HIGH AND LOW TEMPERATURES

No.	CHARACTERISTICS	SYMBOL	MIL-STD-750 TEST METHOD	TEST CONDITIONS	LIMITS		UNIT
					MIN.	MAX.	
1	Collector-Base Cut-off Current	I_{CES}	3041	$T_{amb} = +150^{\circ}C$ $V_{CE} = 20V$	-	30	μA
2	D.C. Forward Current Transfer Ratio 1	h_{FE1}	3076	$T_{amb} = -55^{\circ}C$ $V_{CE} = 0.35V$ $I_C = 10mA$ Note 1	15	-	-

NOTES

1. Pulse measurement: Pulse Length = $300\mu s$, Duty Cycle $\leq 1.0\%$.



FIGURE 4 - CIRCUITS FOR ELECTRICAL MEASUREMENTS

TURN-ON AND TURN-OFF TIME TEST CIRCUIT

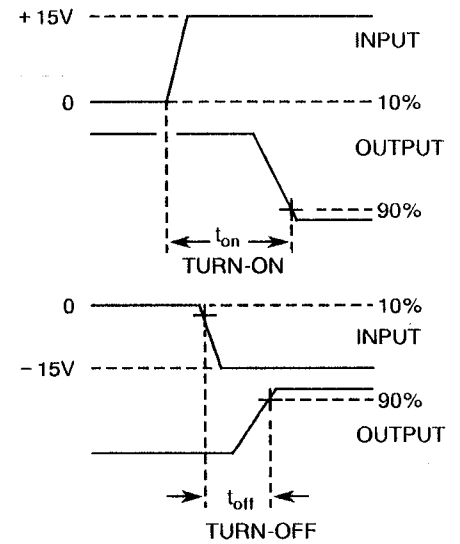
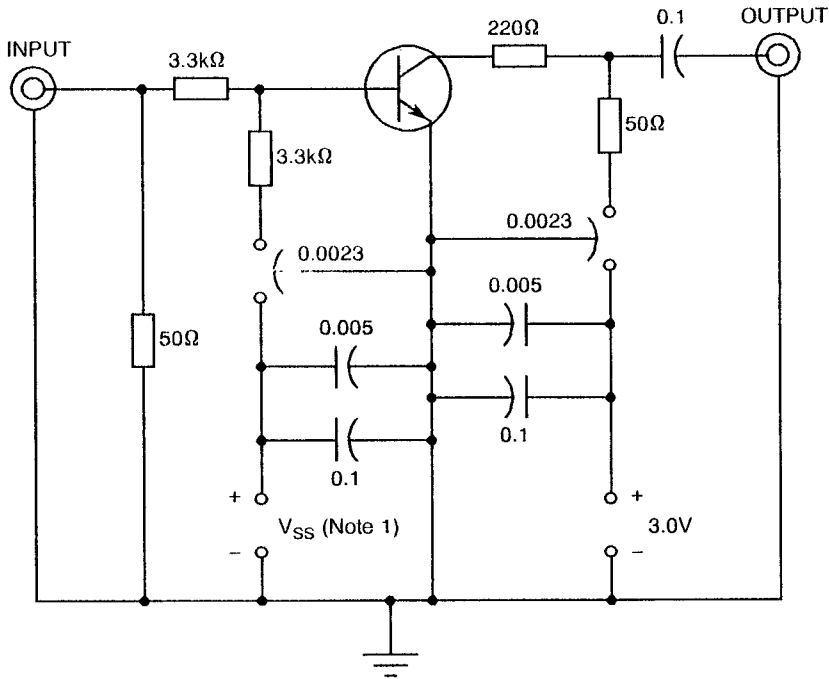

VOLTAGE WAVEFORMS

NOTES

1. $V_{SS} = -3.0V$ for t_{on} and $+12V$ for t_{off} .
2. All capacitance in pF.
3. The input waveforms for each circuit are supplied by a pulse generator with the following characteristics:
 $Z_{OUT} = 50\Omega$, $t_r \leq 1.0ns$, $PW \geq 300ns$, duty cycle $\leq 2.0\%$.
4. Output waveforms are monitored on an oscilloscope with the following characteristics: $t_r \leq 1.0ns$, $Z_{in} = 50\Omega$.

TABLE 4 - PARAMETER DRIFT VALUES

No.	CHARACTERISTICS	SYMBOL	SPEC. AND/OR TEST METHOD	TEST CONDITIONS	CHANGE LIMIT (Δ)	UNIT
1	Collector-Base Cut-off Current	I_{CES}	As per Table 2	As per Table 2	25 or (1) ± 100	nA %
2	D.C. Forward Current Transfer Ratio 1	h_{FE1}	As per Table 2	As per Table 2	± 15	%
3	Collector-Emitter Saturation Voltage	$V_{CE(SAT)}$	As per Table 2	As per Table 2	25 or (1) ± 15	mV %

NOTES

1. Whichever is the greater, referred to the initial value.

TABLE 5(a) - CONDITIONS FOR HIGH TEMPERATURE REVERSE BIAS BURN-IN

Not applicable.

TABLE 5(b) - CONDITIONS FOR POWER BURN-IN AND OPERATING LIFE TESTS

No.	CHARACTERISTICS	SYMBOL	CONDITION	UNIT
1	Ambient Temperature	T_{amb}	+ 25 to + 50	$^{\circ}C$
2	Power Dissipation 1	P_{10t1}	Choose according to derating diagram (Note 1)	mW
3	Collector-Base Voltage	V_{CB}	10	V

NOTES



1. See Item 5 of Table 1(b) and Figure 1.

FIGURE 5(a) - ELECTRICAL CIRCUIT FOR HIGH TEMPERATURE REVERSE BIAS BURN-IN

Not applicable.

FIGURE 5(b) - ELECTRICAL CIRCUIT FOR POWER BURN-IN AND OPERATING LIFE TESTS

Not applicable.

 	<p style="text-align: center;">ESA/SCC Detail Specification No. 5201/006</p>		<p>PAGE 17 ISSUE 3</p>
--------------------------------------------------------------------------------------------------------------------------------------------------------------------	----------------------------------------------------------------------------------	--	----------------------------

4.8 ENVIRONMENTAL AND ENDURANCE TESTS (CHARTS IV AND V OF ESA/SCC GENERIC SPECIFICATION No. 5000)

4.8.1 Electrical Measurements on Completion of Environmental Tests

The parameters to be measured on completion of environmental tests are scheduled in Table 2. Unless otherwise stated, the measurements shall be performed at $T_{amb} = +22 \pm 3$ °C.

4.8.2 Electrical Measurements at Intermediate Points and on Completion of Endurance Tests

The parameters to be measured at intermediate points and on completion of endurance testing are scheduled in Table 6 of this specification. Unless otherwise stated, the measurements shall be performed at $T_{amb} = +22 \pm 3$ °C.

4.8.3 Conditions for Operating Life Tests (Part of Endurance Testing)

The requirements for operating life testing are specified in Section 9 of ESA/SCC Generic Specification No. 5000. The conditions for operating life testing shall be the same as specified in Table 5(b) for the power burn-in test.

4.8.4 Electrical Circuits for Operating Life Tests

The circuit to be used for performance of the operating life test shall be the same as shown in Figure 5(b) for power burn-in.

4.8.5 Conditions for High Temperature Storage Test (Part of Endurance Testing)

The requirements for the high temperature storage test are specified in ESA/SCC Generic Specification No. 5000. The temperature to be applied shall be the maximum storage temperature specified in Table 1(b) of this specification.

TABLE 6 - ELECTRICAL MEASUREMENTS AT INTERMEDIATE POINTS AND ON COMPLETION OF ENDURANCE TESTING

No.	CHARACTERISTICS	SYMBOL	SPEC. AND/OR TEST METHOD	TEST CONDITIONS	LIMITS		UNIT
					MIN.	MAX.	
1	D.C. Forward Current Transfer Ratio 1	h_{FE1}	As per Table 2	As per Table 2	40	120	-
2	Collector-Emitter Saturation Voltage	$V_{CE(SAT)}$	As per Table 2	As per Table 2	-	0.5	V
3	Collector-Base Cut-off Current	I_{CES}	As per Table 2	As per Table 2	-	400	nA



SCC

ESA/SCC Detail Specification
No. 5201/006

Rev. 'A'

PAGE 20

ISSUE 3

APPENDIX 'B'

Page 1 of 1

AGREED DEVIATIONS FOR SGS-THOMSON (F)

ITEMS AFFECTED	DESCRIPTION OF DEVIATIONS
Para. 4.2.2	<p>For Chip Carrier Variants, the visual criteria called up by Para. 9.1, as specified in Paras. 3.2.5(i) and (j) of ESA/SCC Basic Specification No. 2045000, may be omitted provided that a Radiographic Inspection to verify the die-attach process is performed in accordance with Para. 9.12.</p> <p>The Radiographic Inspection shall be performed on a sample basis in accordance with STC Procedure 0011828.</p>