



europaean space agency
agence spatiale européenne

Pages 1 to 22

TRANSISTORS, SILICON, NPN,

POWER SWITCHING

BASED ON TYPE 2N4150

ESA/SCC Detail Specification No. 5208/008



**space components
coordination group**

Issue/Rev.	Date	Approved by	
		SCCG Chairman	ESA Director General or his Deputy
Issue 1	April 1983		
Revision 'A'	February 1992	<i>P. Rommens</i>	<i>J. Lab</i>
Revision 'B'	August 1996	<i>Sam Mitchell</i>	<i>J. Storm</i>



DOCUMENTATION CHANGE NOTICE

Rev. Letter	Rev. Date	Reference	CHANGE Item	Approved DCR No.	
'A'	Feb. '92	This Issue incorporates all modifications agreed on the basis of Policy DCR 21019 (Appendices to Detail Specifications), Policy DCR 21022 and Policy DCR 21025.			
		P1.	Cover page	None	
		P2.	DCN	None	
		P5.	Para. 1.2	: Paragraph amended	21021
			Para. 2	: "ESA/SCC Basic Spec. No. 23500" added	21025
		P10.	Para. 4.2.2	: Bond Strength and Die Shear Test deviations deleted	23499
				: PIND deviation deleted	21043
	Para. 4.2.3	: Radiographic Inspection deviation deleted	21049		
P11.	Para. 4.2.4	: Bond Strength and Die Shear Test deviations deleted, subsequent deviation renumbered	23499		
P17.	Table 3	: Reference to Note 2 deleted, Note 1 put under this table	21047		
		This document has been transferred from hardcopy to electronic format. The content is unchanged but minor differences in presentation exist.			
'B'	Aug. '96	P1.	Cover page	None	
		P2.	DCN	None	
		P5.	Para. 1.7	: Paragraph added	21083



	ESA/SCC Detail Specification No. 5208/008	PAGE 3 ISSUE 1
---	--	-------------------

TABLE OF CONTENTS

		<u>Page</u>
1.	<u>GENERAL</u>	5
1.1	Scope	5
1.2	Component Type Variants	5
1.3	Maximum Ratings	5
1.4	Parameter Derating Information	5
1.5	Physical Dimensions	5
1.6	Functional Diagram	5
1.7	High Temperature Test Precautions	5
2.	<u>APPLICABLE DOCUMENTS</u>	5
3.	<u>TERMS, DEFINITIONS, ABBREVIATIONS, SYMBOLS AND UNITS</u>	10
4.	<u>REQUIREMENTS</u>	10
4.1	General	10
4.2	Deviations from Generic Specification	10
4.2.1	Deviations from Special In-process Controls	10
4.2.2	Deviations from Final Production Tests (Chart II)	10
4.2.3	Deviations from Burn-in and Electrical Measurements (Chart III)	10
4.2.4	Deviations from Qualification Tests (Chart IV)	11
4.2.5	Deviations from Lot Acceptance Tests (Chart V)	11
4.3	Mechanical Requirements	11
4.3.1	Dimension Check	11
4.3.2	Weight	11
4.3.3	Terminal Strength	11
4.4	Materials and Finishes	11
4.4.1	Case	12
4.4.2	Lead Material and Finish	12
4.5	Marking	12
4.5.1	General	12
4.5.2	Lead Identification	12
4.5.3	The SCC Component Number	12
4.5.4	Traceability Information	12
4.5.5	Marking of Small Components	13

	<p style="text-align: center;">ESA/SCC Detail Specification No. 5208/008</p>	<p>PAGE 4 ISSUE 1</p>
---	--	---------------------------

	<u>Page</u>
4.6 Electrical Measurements	13
4.6.1 Electrical Measurements at Room Temperature	13
4.6.2 Electrical Measurements at High and Low Temperatures	13
4.6.3 Circuits for Electrical Measurements	13
4.7 Burn-in Tests	13
4.7.1 Parameter Drift Values	13
4.7.2 Conditions for Burn-in	14
4.7.3 Electrical Circuits for Burn-in	14
4.8 Environmental and Endurance Tests	19
4.8.1 Electrical Measurements on Completion of Environmental Tests	19
4.8.2 Electrical Measurements at Intermediate Points and on Completion of Endurance Tests	19
4.8.3 Conditions for Operating Life Tests (Part of Endurance Testing)	19
4.8.4 Electrical Circuits for Operating Life Tests	19
4.8.5 Conditions for High Temperature Storage Test (Part of Endurance Testing)	19

TABLES



1(a) Type Variants	6
1(b) Maximum Ratings	6
2 Electrical Measurements at Room Temperature - d.c. Parameters	15
Electrical Measurements at Room Temperature - a.c. Parameters	16
3 Electrical Measurements at High and Low Temperatures	17
4 Parameter Drift Values	17
5 Conditions for Burn-in and Operating Life Tests	19
6 Electrical Measurements after Environmental Tests and at Intermediate Points and on Completion of Endurance Testing	21

FIGURES

1 Parameter Derating Information	7
2 Physical Dimensions	8
3 Functional Diagram	9
4 Circuits for Electrical Measurements	18

APPENDICES (Applicable to specific Manufacturers only)

'A' Agreed Deviations for Unitrode (USA)	22
--	----

 	<p style="text-align: center;">ESA/SCC Detail Specification No. 5208/008</p>	<p style="text-align: center;">Rev. 'B'</p>	<p>PAGE 5 ISSUE 1</p>
---	--	---	---------------------------

1. GENERAL

1.1 SCOPE

This specification details the ratings, physical and electrical characteristics, test and inspection data for a Transistor, Silicon, Power Switching, NPN, based on Type 2N4150.

It shall be read in conjunction with ESA/SCC Generic Specification No. 5000, the requirements of which are supplemented herein.

1.2 COMPONENT TYPE VARIANTS

See Table 1(a).

1.3 MAXIMUM RATINGS

The maximum ratings, which shall not be exceeded at any time during use or storage, applicable to the transistors specified herein are scheduled in Table 1(b).

1.4 PARAMETER DERATING INFORMATION

The derating information applicable to the transistors specified herein is shown in Figure 1.

1.5 PHYSICAL DIMENSIONS

The physical dimensions of the transistors specified herein are shown in Figure 2.

1.6 FUNCTIONAL DIAGRAM

The functional diagram showing lead identification, of the transistors specified herein, is shown in Figure 3.

1.7 HIGH TEMPERATURE TEST PRECAUTIONS

For tin-lead plated or solder-dipped lead finish, all tests to be performed at a temperature that exceeds +125°C shall be carried out in a 100% inert atmosphere.

2. APPLICABLE DOCUMENTS

The following documents form part of this specification and shall be read in conjunction with it:-

- (a) ESA/SCC Generic Specification No. 5000 for Discrete Semiconductor Components.
- (b) MIL-STD-750, Test Methods and Procedures for Semiconductor Devices.
- (c) ESA/SCC Basic Specification No. 23500, Requirements for Lead Materials and Finishes for Components for Space Application.

TABLE 1(a) - TYPE VARIANTS

VARIANT	CASE	FIGURE	LEAD MATERIAL AND FINISH
01	TO5	2	D2
02	TO5	2	D3 or D4

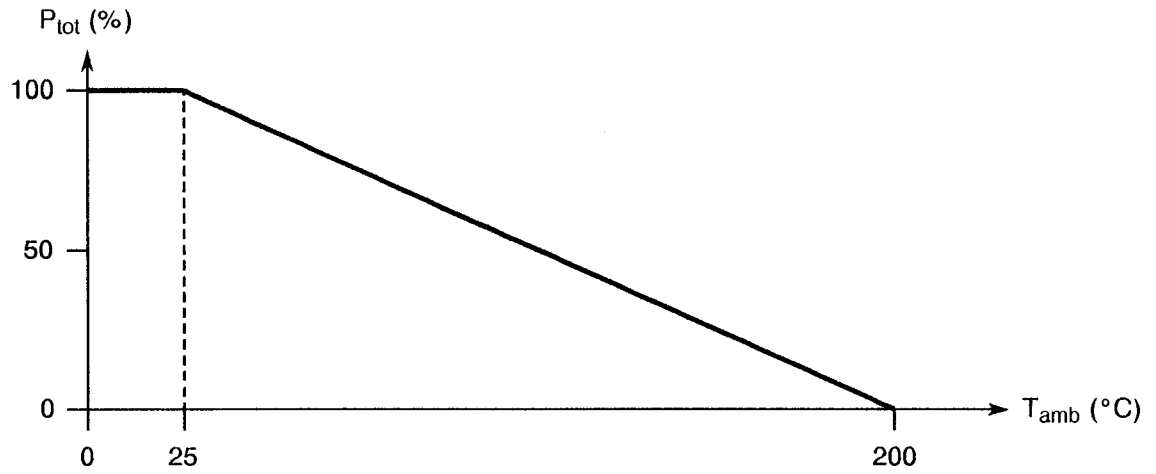
TABLE 1(b) - MAXIMUM RATINGS

No.	CHARACTERISTICS	SYMBOL	MAXIMUM RATINGS	UNIT	REMARKS
1	Collector-Base Breakdown Voltage	$V_{(BR)CBO}$	100	V	
2	Collector-Emitter Breakdown Voltage	$V_{(BR)CEO}$	70	V	
3	Emitter-Base Breakdown Voltage	$V_{(BR)EBO}$	7.0	V	
4	Collector Current	I_C	10	A	
5	Power Dissipation	P_{tot}	1.5	W	Note 1
6	Operating Temperature Range	T_{op}	- 65 to + 200	°C	T_{amb}
7	Storage Temperature Range	T_{stg}	- 65 to + 200	°C	
8	Soldering Temperature	T_{sol}	+ 300	°C	Note 2
9	Thermal Resistance	$R_{TH(J-C)}$	20	°C/W	

NOTES

1. At $T_{amb} \leq +25^{\circ}C$. For derating at $T_{amb} > +25^{\circ}C$, see Figure 1.
2. Duration 10 seconds maximum at a distance of not less than 1.5mm from the device body and the same lead shall not be resoldered until 3 minutes have elapsed.

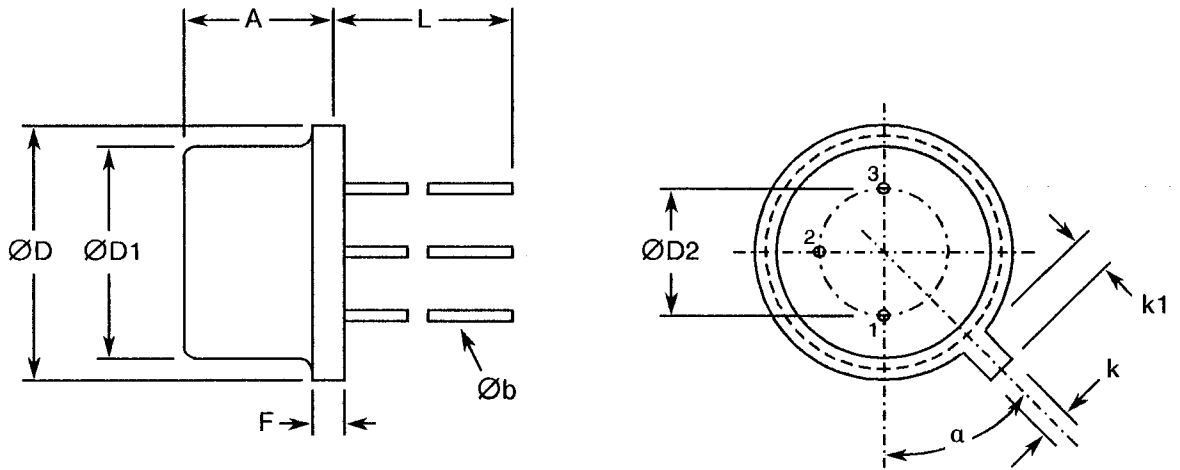
FIGURE 1 - PARAMETER DERATING INFORMATION



Power Dissipation versus Temperature

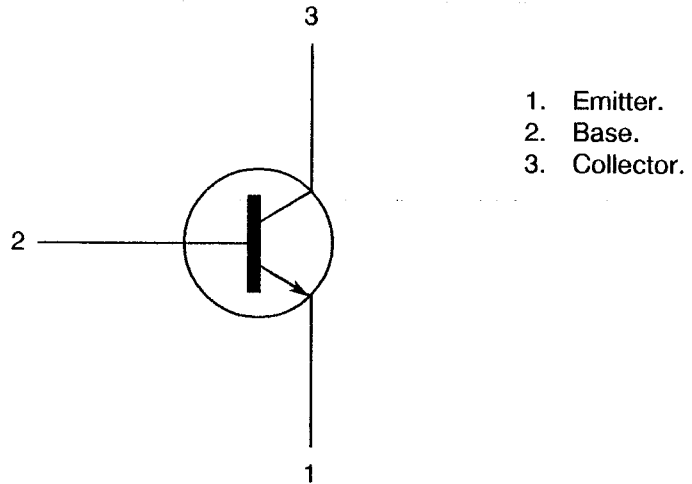


FIGURE 2 - PHYSICAL DIMENSIONS





SYMBOL	INCHES		MILLIMETRES	
	MIN.	MAX.	MIN.	MAX.
A	0.240	0.260	6.090	6.600
$\varnothing b$	0.016	0.019	0.407	0.483
$\varnothing D$	0.335	0.370	8.510	9.400
$\varnothing D1$	0.305	0.335	7.750	8.510
$\varnothing D2$	0.190	0.210	4.830	5.530
F	0.010	0.030	0.254	0.762
k	0.028	0.034	0.711	0.863
k1	0.029	0.045	0.736	1.114
L	1.500	-	38.10	-
a	42°	48°	42°	48°

FIGURE 3 - FUNCTIONAL DIAGRAM



NOTES

1. The collector is internally connected to the case.

 	<p style="text-align: center;">ESA/SCC Detail Specification No. 5208/008</p>	<p style="text-align: center;">Rev. 'A'</p>	<p style="text-align: right;">PAGE 10 ISSUE 1</p>
---	--	---	---

3. TERMS, DEFINITIONS, ABBREVIATIONS, SYMBOLS AND UNITS

For the purpose of this specification, the terms, definitions, abbreviations, symbols and units specified in ESA/SCC Basic Specification No. 21300 shall apply.

4. REQUIREMENTS

4.1 GENERAL

The complete requirements for procurement of the transistors specified herein are stated in this specification and ESA/SCC Generic Specification No. 5000. Deviations from the Generic Specification, applicable to this specification only, are listed in Para. 4.2.

Deviations from the applicable Generic Specification and this Detail Specification, formally agreed with specific Manufacturers on the basis that the alternative requirements are equivalent to the ESA/SCC requirements and do not affect the components' reliability, are listed in the appendices attached to this specification.

4.2 DEVIATIONS FROM GENERIC SPECIFICATION

4.2.1 Deviations from Special In-process Controls

None.

4.2.2 Deviations from Final Production Tests (Chart II)

None.

4.2.3 Deviations from Burn-in and Electrical Measurements (Chart III)

(a) H.T.R.B. test: Shall not be performed.



4.2.4 Deviations from Qualification Tests (Chart IV)

- (a) The electrical measurements specified at the end of Subgroup I and II tests shall be performed as stated in Table 6 of this specification.

4.2.5 Deviations from Lot Acceptance Tests (Chart V)

- (a) The electrical measurements referenced Para. 9.9.3 shall be performed as stated in Table 6 of this specification.

4.3 MECHANICAL REQUIREMENTS

4.3.1 Dimension Check

The dimensions of the transistors specified herein shall be checked. They shall conform to those shown in Figure 2.

4.3.2 Weight

The maximum weight of the transistors specified herein shall be 12 grammes.

4.3.3 Terminal Strength

The requirements for terminal strength testing are specified in Section 9 of ESA/SCC Generic Specification No. 5000. The test conditions shall be as follows:-

Test Condition: 'E', Lead Fatigue.

Applied Force: 5.0 ± 0.1 Newtons.

4.4 MATERIALS AND FINISHES

The materials and finishes shall be as specified herein. Where a definite material is not specified, a material which will enable the transistors specified herein to meet the performance requirements of this specification shall be used. Acceptance or approval of any constituent material does not guarantee acceptance of the finished product.

4.4.1 Case

Metal case, hermetically sealed, similar to JEDEC TO-5.

4.4.2 Lead Material and Finish

The lead material shall be Type 'D' with either Type '2' or Type '3 or 4' finish in accordance with the requirements of ESA/SCC Basic Specification No. 23500. (See Table 1(a) for Type Variants).

4.5 MARKING

4.5.1 General

The marking of all components delivered to this specification shall be in accordance with the requirements of ESA/SCC Basic Specification No. 21700. Each component shall be marked in respect of:-

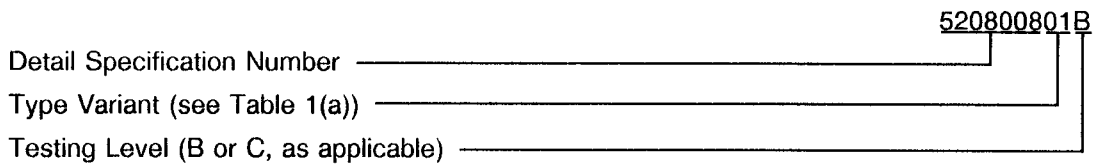
- (a) Lead Identification.
- (b) The SCC Component Number.
- (c) Traceability Information.

4.5.2 Lead Identification

Lead identification shall be as shown in Figures 2 and 3.

4.5.3 The SCC Component Number

Each component shall bear the SCC Component Number which shall be constituted and marked as follows:-



4.5.4 Traceability Information

Each component shall be marked in respect of traceability information in accordance with the requirements of ESA/SCC Basic Specification No. 21700.



4.5.5 Marking of Small Components

When it is considered that the component is too small to accommodate the marking as specified above, as much as space permits shall be marked. The order of precedence shall be as follows:-

- (a) Lead Identification.
- (b) The SCC Component Number.
- (c) Traceability Information.

The marking information in full shall accompany each component in its primary package.

4.6 ELECTRICAL MEASUREMENTS

4.6.1 Electrical Measurements at Room Temperature

The parameters to be measured at room temperature are scheduled in Table 2. Unless otherwise specified, measurements shall be performed at $T_{amb} = +25 \pm 3$ °C.

4.6.2 Electrical Measurements at High and Low Temperatures

The parameters to be measured at high and low temperatures are scheduled in Table 3.


4.6.3 Circuits for Electrical Measurements

Circuits for use in performing the electrical measurements listed in Tables 2 and 3 of this specification are shown in Figure 4.

4.7 BURN-IN TESTS

4.7.1 Parameter Drift Values

The parameter drift values applicable to burn-in are specified in Table 4 of this specification. Unless otherwise stated, measurements shall be performed at $T_{amb} = +25 \pm 3$ °C. The parameter drift values (Δ) applicable to the parameters scheduled shall not be exceeded. In addition to these drift value requirements, the appropriate limit value specified for a given parameter in Table 2 shall not be exceeded.

	ESA/SCC Detail Specification No. 5208/008		PAGE 14 ISSUE 1
---	--	--	--------------------

4.7.2 Conditions for Burn-in

The requirements for burn-in are specified in Section 7 of ESA/SCC Generic Specification No. 5000. The conditions for burn-in shall be as specified in Table 5 of this specification.

4.7.3 Electrical Circuits for Burn-in

Not applicable.

**TABLE 2 - ELECTRICAL MEASUREMENTS AT ROOM TEMPERATURE - d.c. PARAMETERS**

No.	CHARACTERISTICS	SYMBOL	MIL-STD-750 TEST METHOD	TEST CONDITIONS	LIMITS		UNIT
					MIN	MAX	
1	Collector-Base Breakdown Voltage	BV_{CBO}	3001 Bias Cond. D	$I_C = 10\mu A$	100	-	V
2	Collector-Emitter Breakdown Voltage	BV_{CEO}	3011 Bias Cond. D	$I_C = 100mA$ Note 1	70	-	V
3	Emitter-Base Breakdown Voltage	BV_{EBO}	3026	$I_E = 10\mu A$	7.0	-	V
4	Collector-Emitter Cut-off Current	I_{CEO}	3041 Bias Cond. D		-	10	μA
5	Collector-Emitter Cut-off Current	I_{CEX}	3041 Bias Cond. A	$V_{BE} = -0.5V$ $V_{CE} = 100V$	-	10	μA
6	Collector-Base Cut-off Current	I_{CBO}	3036 Bias Cond. D	$V_{CB} = 80V$ $I_E = 0A$	-	100	nA
7	Emitter-Base Cut-off Current	I_{EBO}	3061 Bias Cond. D	$V_{EB} = 5.0V$	-	100	nA
8	D.C. Forward Current Transfer Ratio 1	h_{FE1}	3076	$V_{CE} = 5.0V$ $I_C = 5.0A$ Note 1	40	120	-
9	D.C. Forward Current Transfer Ratio 2	h_{FE2}	3076	$V_{CE} = 5.0V$ $I_C = 10A$ Note 1	10	-	-
10	D.C. Forward Current Transfer Ratio 3	h_{FE3}	3076	$V_{CE} = 5.0V$ $I_C = 1.0A$ Note 1	50	-	-
11	Collector-Emitter Saturation Voltage	$V_{CE(SAT)}$	3071	$I_C = 5.0A$ $I_B = 0.5A$ Note 1	-	0.6	V
12	Base-Emitter Saturation Voltage	$V_{BE(SAT)}$	3066 Cond. A	$I_C = 5.0A$ $I_B = 0.5A$ Note 1	-	1.5	V

NOTES: See Page 16.

**TABLE 2 - ELECTRICAL MEASUREMENTS AT ROOM TEMPERATURE - a.c. PARAMETERS**

No.	CHARACTERISTICS	SYMBOL	MIL-STD-750 TEST METHOD	TEST FIG.	TEST CONDITIONS (NOTE 2)	LIMITS		UNIT
						MIN	MAX	
13	Small Signal Short Circuit Forward Current Transfer Ratio	h_{fe}	3206	-	$V_{CE} = 5.0V$ $I_C = 50mA$ $f = 1.0kHz$	40	160	-
14	Magnitude of Small Signal Short Circuit Forward Current Transfer Ratio	h_{fe}	3306	-	$V_{CE} = 10V$ $I_C = 0.2A$ $f = 10MHz$	1.5	7.5	-
15	Open Circuit Output Capacitance	C_{obo}	3236	-	$V_{CB} = 10V$ $I_E = 0A$ $f = 100kHz$ to 1.0MHz	-	350	pF
16	Peak Current	I_P	-	4	$V_{CC} = 28V$ $V_{BB} = 5.0V$ $I_C = 5.0A$ Input Pulse:- $I_B = 1.0A$ $V_P = 50V$	18	-	A
17	Pulse Rise Time	t_r			$t_p = 2.0\mu s$ $t_r \leq 20ns$	-	1.0	μs
18	Pulse Storage Time	t_s			$t_f \leq 20ns$	-	500	ns
19	Pulse Fall Time	t_f			Note 1	-	700	ns

NOTES

- Pulsed measurement: Pulse Width $\leq 2.0\mu s$, Duty Cycle $\leq 1.0\%$.
- If more than 20 units have to be measured, the measurements shall be made on a sample basis in accordance with Level II, Table IIa, AQL = 1.0% of MIL-STD-105.
For test numbers 16 through 19, measurements shall be made on all units irrespective of lot size.



 	ESA/SCC Detail Specification No. 5208/008	Rev. 'A'	PAGE 17
			ISSUE 1

TABLE 3 - ELECTRICAL MEASUREMENTS AT HIGH AND LOW TEMPERATURES

No.	CHARACTERISTICS	SYMBOL	MIL-STD-750 TEST METHOD	TEST CONDITIONS	LIMITS		UNIT
					MIN	MAX	
5	Collector-Emitter Cut-off Current	I_{CEX}	3041 Bias Cond. A	$T_{case} = +150^{\circ}C$ $V_{CE} = 80V$ $V_{BE} = -0.5V$	-	100	μA
8	D.C. Forward Current Transfer Ratio 1	h_{FE1}	3076	$T_{amb} = -55^{\circ}C$ $I_C = 5.0A$ $V_{CE} = 5.0V$ Note 1	20	-	-

NOTES

1. Pulsed measurement: Pulse Width $\leq 2.0\mu s$, Duty Cycle $\leq 1.0\%$.

TABLE 4 - PARAMETER DRIFT VALUES

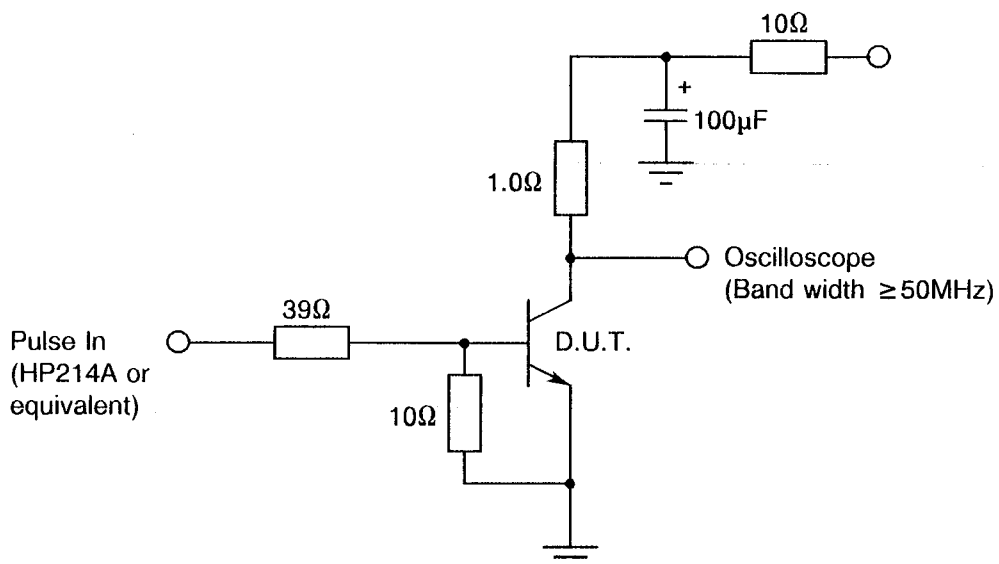
No.	CHARACTERISTICS	SYMBOL	SPEC. AND/OR TEST METHOD	TEST CONDITIONS	CHANGE LIMITS (Δ)	UNIT
6	Collector-Base Cut-off Current	I_{CBO}	As per Table 2	As per Table 2	± 50 or (1) ± 100	nA %
8	D.C. Forward Current Transfer Ratio 1	h_{FE1}	As per Table 2	As per Table 2	+20 - 10	%

NOTES

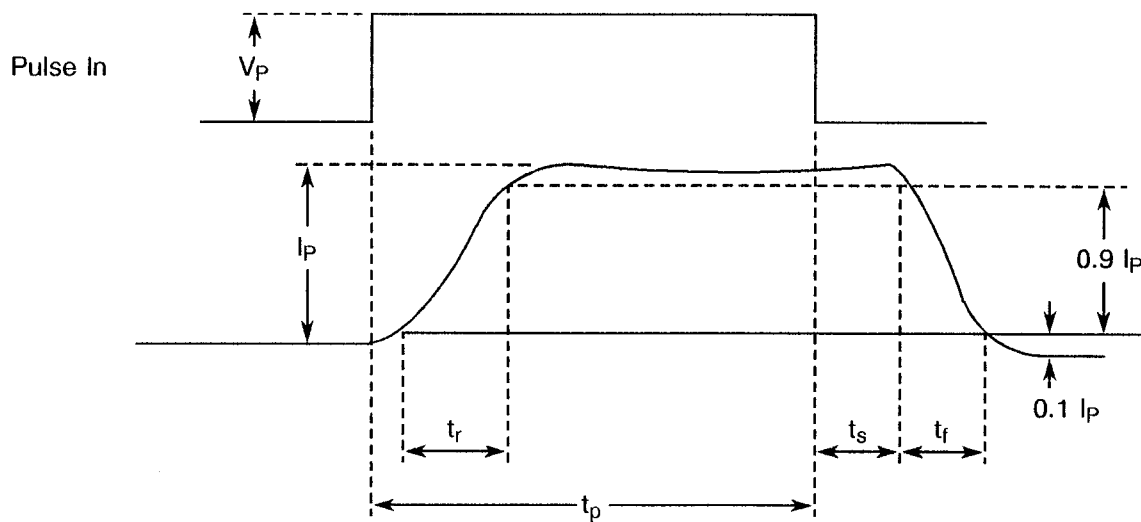
1. Whichever is greater, referred to the initial value.

FIGURE 4 - CIRCUITS FOR ELECTRICAL MEASUREMENTS

CIRCUIT FOR SWITCHING SPEED MEASUREMENTS



SWITCHING WAVEFORMS



**TABLE 5 - CONDITIONS FOR BURN-IN AND OPERATING LIFE TESTS**

No.	CHARACTERISTICS	SYMBOL	CONDITIONS	UNIT
1	Ambient Temperature	T_{amb}	$+25 \pm 3$	$^{\circ}\text{C}$
2	Collector-Base Voltage	V_{CB}	45	V
3	Power Dissipation	P_{tot}	1.5 (Note 1)	W

NOTES


1. No heat sink or forced air directed on the device shall be permitted.



- 4.8 ENVIRONMENTAL AND ENDURANCE TESTS (CHARTS IV AND V OF ESA/SCC GENERIC SPECIFICATION NO. 5000)
- 4.8.1 Electrical Measurements on Completion of Environmental Tests
The parameters to be measured on completion of environmental tests are scheduled in Table 6. The measurements shall be performed at $T_{amb} = +25 \pm 3$ °C.
- 4.8.2 Electrical Measurements at Intermediate Points and on Completion of Endurance Tests
The parameters to be measured at intermediate points and on completion of endurance testing are scheduled in Table 6 of this specification.
- 4.8.3 Conditions for Operating Life Tests (Part of Endurance Testing)
The requirements for operating life testing are specified in Section 9 of ESA/SCC Generic Specification No. 5000. The conditions for operating life testing shall be the same as specified in Table 5 for the burn-in test.
- 4.8.4 Electrical Circuits for Operating Life Tests
Not applicable.
- 4.8.5 Conditions for High Temperature Storage Test (Part of Endurance Testing)
The requirements for the high temperature storage test are specified in ESA/SCC Generic Specification No. 5000. The temperature to be applied shall be the maximum storage temperature specified in Table 1(b) of this specification.

TABLE 6 - ELECTRICAL MEASUREMENTS AFTER ENVIRONMENTAL TESTS AND AT INTERMEDIATE POINTS AND ON COMPLETION OF ENDURANCE TESTING

No.	CHARACTERISTICS	SYMBOL	SPEC. AND/OR TEST METHOD	TEST CONDITIONS	CHANGE LIMITS (Δ)	LIMITS		UNIT
						MIN.	MAX.	
6	Collector-Base Cut-off Current	I_{CBO}	As per Table 2	As per Table 2	-	-	200	nA
7	Emitter-Base Cut-off Current	I_{EBO}	As per Table 2	As per Table 2	-	-	200	nA
8	D.C. Forward Current Transfer Ratio 1	h_{FE1}	As per Table 2	As per Table 2	+ 20% to - 10%	-	-	-

	<p>ESA/SCC Detail Specification No. 5208/008</p>	<p>PAGE 22 ISSUE 1</p>
---	--	----------------------------

APPENDIX 'A'

Page 1 of 1

AGREED DEVIATIONS FOR UNITRODE (USA)

ITEMS AFFECTED	DESCRIPTION OF DEVIATIONS
Para's 4.2.2 and 4.2.4	Internal (Pre-encapsulation) Visual Inspection may be performed to Method 2074 of MIL-STD-750.
Para's 4.2.2, 4.2.3, 4.2.4 and 4.2.5	External Visual Inspection may be performed to Method 2071 of MIL-STD-750.
Para. 4.2.3	Radiographic Inspection may be performed to Method 2076 of MIL-STD-750.