



**european space agency
agence spatiale européenne**

Pages 1 to 15

DIODES, SWITCHING,

BASED ON TYPE UTX 225

ESA/SCC Detail Specification No. 5103/005



**space components
coordination group**

| Issue/Rev. | Date | Approved by | |
|------------|--------------|-----------------|---------------------------------------|
| | | SCCG Chairman | ESA Director General or his Deputy |
| Issue 2 | January 1999 | <i>Sam Mitt</i> | <i>[Signature]</i> |
| | | | |
| | | | |
| | | | |



DOCUMENTATION CHANGE NOTICE

| Rev. Letter | Rev. Date | Reference | CHANGE Item | Approved DCR No. |
|-------------|-----------|--|---|------------------|
| | | This Issue supersedes Issue 1 and incorporates all modifications defined in Revisions 'A', 'B' and 'C' to Issue 1 and the changes agreed in the following DCRs:- | | |
| | | Cover Page | | None |
| | | DCN | | None |
| | | Table 1(b) | : No. 2, Characteristics and Unit amended | 221478 |
| | | | : No. 3, Characteristics and Remarks amended | 221478 |
| | | | : No. 6, "Note 4" added to Remarks | 221478 |
| | | | : Note 2, Note deleted and new note added | 221478 |
| | | | : Note 3, New note added | 221478 |
| | | | : , Existing note renumbered as "4" and text amended | 221478 |
| | | Figure 1 | : Title amended | 221478 |
| | | | : Graph amended | 221478 |
| | | Figure 2 | : Imperial Dimensions deleted | 221478 |
| | | Para. 4.2.2 | : Deviation for Para. 9.2.2 added | 221478 |
| | | | : Deviation for Para. 9.6 added | 221478 |
| | | | : Deviation for Paragraph after Para. 9.8.2 amended | 221478 |
| | | Para. 4.2.4 | : Existing Deviation amended | 221478 |
| | | | : Deviation for Para. 9.2.4 added | 221478 |
| | | | : Deviation for Para. 9.6 added | 221478 |
| | | Para. 4.2.5 | : Deviation for Para. 9.6 added | 221478 |
| | | Para. 4.3.3 | : "(4 Pounds)" deleted from Applied Force | 221478 |
| | | Para. 4.5.1 | : Existing text deleted and new text added | 221478 |
| | | Para. 4.5.2 | : Title and text amended | 221478 |
| | | Para. 4.5.3 | : "Type Variant" amended | 221478 |
| | | Para. 4.5.5 | : Deleted in toto | 221478 |
| | | Para. 4.7.2 | : New paragraph entry added | 221478 |
| | | | : Existing paragraph renumbered as "4.7.3", "Power" added to Title and text and in the second sentence, "5" amended to "5(b)" | 221478 |
| | | Para. 4.7.3 | : Renumbered as "4.7.4" and Title amended | 221478 |
| | | Para. 4.7.5 | : New entry added | 221478 |
| | | Table 5(a) | : Entry added | 221478 |
| | | Table 5 | : Title amended | 221478 |
| | | | : No. 2, Characteristics and Symbol amended | 221478 |
| | | | : No. 6, Item deleted | 221478 |
| | | Para. 4.8.1 | : "Unless otherwise stated," added at the beginning of the second sentence | 221478 |
| | | Paras. 4.8.2 and 4.8.3 | : Paragraphs deleted and replaced by a single new paragraph | 221478 |
| | | | : All subsequent paragraphs renumbered | 221478 |
| | | Para. 4.8.4 | : (New Para. 4.8.3). Second sentence amended | 221478 |
| | | Para. 4.8.6 | : (New Para. 4.8.5). Second sentence deleted and new sentence added | 221478 |

| | | |
|---|--|---------------------------|
|  | <p style="text-align: center;">ESA/SCC Detail Specification No. 5103/005</p> | <p>PAGE 3 ISSUE 2</p> |
|---|--|---------------------------|

TABLE OF CONTENTS

| | | <u>Page</u> |
|-----------|---|-------------|
| 1. | <u>GENERAL</u> | 5 |
| 1.1 | Scope | 5 |
| 1.2 | Component Type Variants | 5 |
| 1.3 | Maximum Ratings | 5 |
| 1.4 | Parameter Derating Information | 5 |
| 1.5 | Physical Dimensions | 5 |
| 1.6 | Functional Diagram | 5 |
| 1.7 | High Temperature Test Precautions | 5 |
| 2. | <u>APPLICABLE DOCUMENTS</u> | 5 |
| 3. | <u>TERMS, DEFINITIONS, ABBREVIATIONS, SYMBOLS AND UNITS</u> | 5 |
| 4. | <u>REQUIREMENTS</u> | 9 |
| 4.1 | General | 9 |
| 4.2 | Deviations from Generic Specification | 9 |
| 4.2.1 | Deviations from Special In-process Controls | 9 |
| 4.2.2 | Deviations from Final Production Tests | 9 |
| 4.2.3 | Deviations from Burn-in and Electrical Measurements | 9 |
| 4.2.4 | Deviations from Qualification Tests | 9 |
| 4.2.5 | Deviations from Lot Acceptance Tests | 9 |
| 4.3 | Mechanical Requirements | 10 |
| 4.3.1 | Dimension Check | 10 |
| 4.3.2 | Weight | 10 |
| 4.3.3 | Terminal Strength | 10 |
| 4.4 | Materials and Finishes | 10 |
| 4.4.1 | Case | 10 |
| 4.4.2 | Lead Material and Finish | 10 |
| 4.5 | Marking | 10 |
| 4.5.1 | General | 10 |
| 4.5.2 | Polarity | 10 |
| 4.5.3 | The SCC Component Number | 11 |
| 4.5.4 | Traceability Information | 11 |
| 4.6 | Electrical Measurements | 11 |
| 4.6.1 | Electrical Measurements at Room Temperature | 11 |
| 4.6.2 | Electrical Measurements at High and Low Temperatures | 11 |
| 4.6.3 | Circuits for Electrical Measurements | 11 |
| 4.7 | Burn-in Tests | 11 |
| 4.7.1 | Parameter Drift Values | 11 |
| 4.7.2 | Conditions for High Temperature Reverse Bias Burn-in | 11 |
| 4.7.3 | Conditions for Power Burn-in | 11 |
| 4.7.4 | Electrical Circuits for High Temperature Reverse Bias Burn-in | 11 |
| 4.7.5 | Electrical Circuits for Power Burn-in | 11 |
| 4.8 | Environmental and Endurance Tests | 15 |
| 4.8.1 | Electrical Measurements on Completion of Environmental Tests | 15 |
| 4.8.2 | Electrical Measurements at Intermediate Points and on Completion of Endurance Tests | 15 |
| 4.8.3 | Conditions for Operating Life Tests | 15 |
| 4.8.4 | Electrical Circuits for Operating Life Tests | 15 |
| 4.8.5 | Conditions for High Temperature Storage Test | 15 |

TABLES



| | | <u>Page</u> |
|------|---|-------------|
| 1(a) | Type Variants | 6 |
| 1(b) | Maximum Ratings | 6 |
| 2 | Electrical Measurements at Room Temperature - d.c. Parameters | 12 |
| | Electrical Measurements at Room Temperature - a.c. Parameters | 12 |
| 3 | Electrical Measurements at High and Low Temperatures | 12 |
| 4 | Parameter Drift Values | 13 |
| 5(a) | Conditions for High Temperature Reverse Bias Burn-in | N/A |
| 5(b) | Conditions for Power Burn-in and Operating Life Tests | 14 |
| 6 | Electrical Measurements at Intermediate Points and on Completion of Endurance Testing | 15 |

FIGURES

| | | |
|------|---|-----|
| 1 | Parameter Derating Information | 7 |
| 2 | Physical Dimensions | 8 |
| 3 | Functional Diagram | 8 |
| 4 | Circuits for Electrical Measurement | 13 |
| 5(a) | Electrical Circuit for High Temperature Reverse Bias Burn-in | N/A |
| 5(b) | Electrical Circuit for Power Burn-in and Operating Life Tests | N/A |

APPENDICES (Applicable to specific Manufacturers only)

None.

| | | |
|---|--|---------------------------|
|   | <p style="text-align: center;">ESA/SCC Detail Specification No. 5103/005</p> | <p>PAGE 5 ISSUE 2</p> |
|---|--|---------------------------|

1. GENERAL

1.1 SCOPE

This specification details the ratings, physical and electrical characteristics, test and inspection data for Diodes, Switching, based on Type UTX 225. It shall be read in conjunction with ESA/SCC Generic Specification No. 5000, the requirements of which are supplemented herein.

1.2 COMPONENT TYPE VARIANTS

Variants of the basic type diodes specified herein, which are also covered by this specification, are given in Table 1(a).

1.3 MAXIMUM RATINGS

The maximum ratings, which shall not be exceeded at any time during use or storage, applicable to the diodes specified herein, are as scheduled in Table 1(b).

1.4 PARAMETER DERATING INFORMATION

The applicable derating information for the diodes specified herein is shown in Figure 1.

1.5 PHYSICAL DIMENSIONS

The physical dimensions of the diodes specified herein are shown in Figure 2.

1.6 FUNCTIONAL DIAGRAM

The functional diagram, showing lead identification of the diodes specified herein, is shown in Figure 3.

1.7 HIGH TEMPERATURE TEST PRECAUTIONS

For tin-lead plated or solder-dipped lead finish, all tests to be performed at a temperature that exceeds +125°C shall be carried out in a 100% inert atmosphere.

2. APPLICABLE DOCUMENTS

The following documents form part of this specification and shall be read in conjunction with it:-

- (a) ESA/SCC Generic Specification No. 5000 for Discrete Semiconductors.
- (b) MIL-STD-750, Test Methods and Procedures for Semiconductor Devices.
- (c) MIL-STD-105, Sampling Procedures and Tables for Inspection by Attributes.

3. TERMS, DEFINITIONS, ABBREVIATIONS, SYMBOLS AND UNITS

For the purpose of this specification, the terms, definitions, abbreviations, symbols and units specified in ESA/SCC Basic Specification No. 21300 shall apply. In addition, the following abbreviation is used:-

C_J = Junction Capacitance.

TABLE 1(a) - TYPE VARIANTS

| VARIANT | BASED ON TYPE | LEAD MATERIAL AND FINISH |
|---------|---------------|--------------------------|
| 01 | UTX 225 | O1 |
| 02 | UTX 225 | A4 |

TABLE 1(b) - MAXIMUM RATINGS

| No. | CHARACTERISTICS | SYMBOL | MAXIMUM RATINGS | UNIT | REMARKS |
|-----|----------------------------------|-----------|-----------------|-------|---------------|
| 1 | Reverse Voltage | V_R | 250 | V | |
| 2 | Forward Surge Current | I_{FSM} | 25 | A(pk) | Note 1 |
| 3 | Average Output Rectified Current | I_O | 2.0 | A | Notes 2 and 3 |
| 4 | Operating Temperature Range | T_{op} | - 65 to +175 | °C | |
| 5 | Storage Temperature Range | T_{stg} | - 65 to +175 | °C | |
| 6 | Soldering Temperature | T_{sol} | +245 | °C | Note 4 |

NOTES

1. Sinusoidal, with period = 8.3ms maximum.
2. At $T_L \leq +25^\circ\text{C}$. For derating at $T_L > +75^\circ\text{C}$, see Figure 1.
3. Lead temperature is measured at 9.53mm from the device body.
4. Duration 10 seconds maximum at a distance of not less than 1.5mm from the device body and the same lead shall not be resoldered until 3 minutes have elapsed.



FIGURE 1 - PARAMETER DERATING INFORMATION

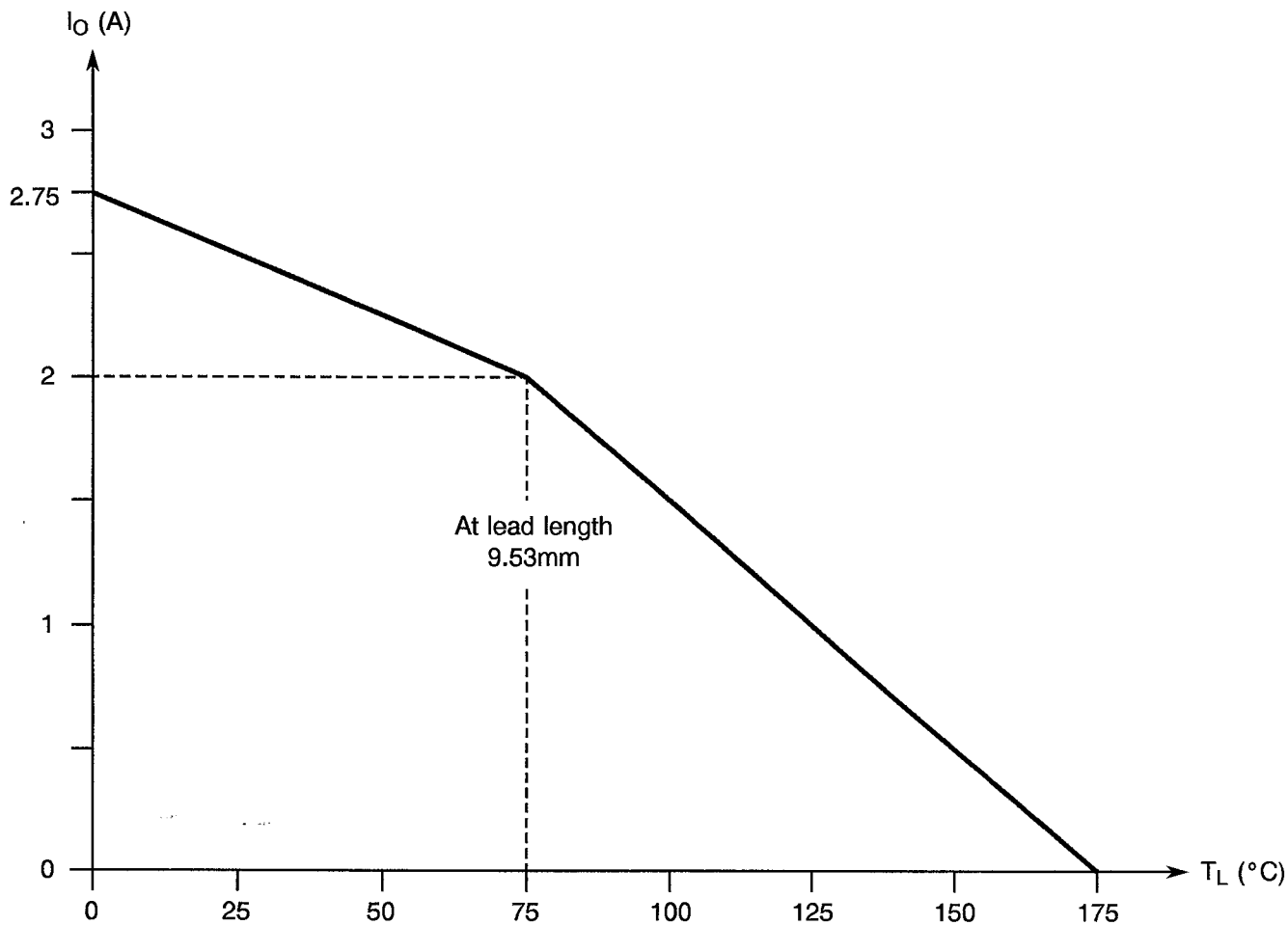

Average Output Rectified Current versus Temperature

FIGURE 2 - PHYSICAL DIMENSIONS

DO5 OUTLINE

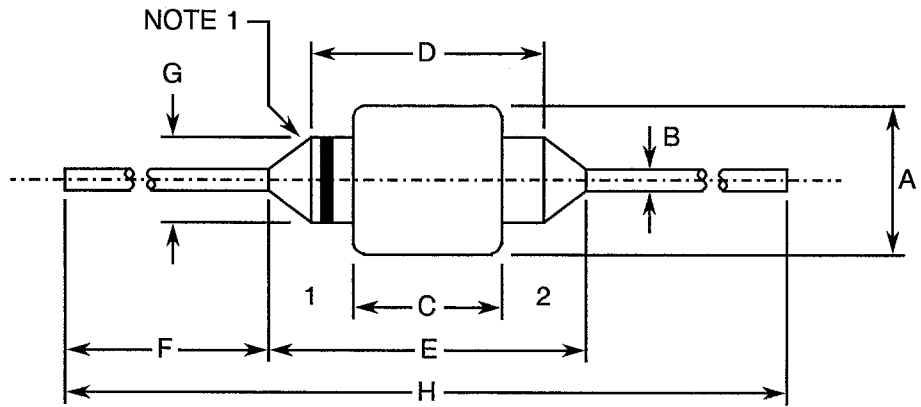

| SYMBOL | MILLIMETRES | | NOTES |
|--------|-------------|------|-------|
| | MIN. | MAX | |
| A | - | 2.20 | |
| B | 0.68 | 0.74 | |
| C | - | 2.30 | |
| D | - | 4.00 | |
| E | - | 6.35 | |
| F | 17.80 | - | |
| G | - | 1.50 | |
| H | 41.30 | - | |

FIGURE 3 - FUNCTIONAL DIAGRAM

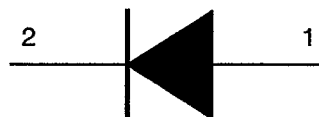

- 1. Anode.
- 2. Cathode.

NOTES

- 1. The cathode end shall be marked with a coloured ring.

| | | |
|---|--|-------------------|
|  | ESA/SCC Detail Specification No. 5103/005 | PAGE 9 ISSUE 2 |
|---|--|-------------------|

4. REQUIREMENTS

4.1 GENERAL

The complete requirements for procurement of the diodes specified herein shall be as stated in this specification and ESA/SCC Generic Specification No. 5000 for Discrete Semiconductors. Deviations from the Generic Specification, applicable to this specification only, are listed in Para. 4.2.

Deviations from the applicable Generic Specification and this Detail Specification, formally agreed with specific Manufacturers on the basis that the alternative requirements are equivalent to the ESA/SCC requirements and do not affect the components' reliability, are listed in the appendices attached to this specification.

4.2 DEVIATIONS FROM GENERIC SPECIFICATION

4.2.1 Deviations from Special In-process Controls

None.

4.2.2 Deviations from Final Production Tests (Chart II)

- (a) Para. 9.2.1, Bond Strength Test: Not applicable.
- (b) Para. 9.2.2, Die Shear Test: Not applicable.
- (c) Para. 9.6, Constant Acceleration: Not applicable.
- (d) Para. 9.7, Particle Impact Noise Detection (PIND) test: Not applicable.
- (e) The following test shall be added after Para. 9.8.2, Seal Test Gross Leak, and before Para. 9.9.3, Electrical Measurements at Room Temperature:-

Surge Current in accordance with Test Method 4066 of MIL-STD-750. The following test conditions shall apply:-

| | | |
|------------------|---|-------------------------------|
| T_{amb} | = | $+25 \pm 3$ °C. |
| I_{FSM} | = | 25A. |
| Number of pulses | = | 5. |
| Pulse Rate | = | 1 pulse/minute. |
| t_p | = | 8.3ms, Sinusoidal Pulse Form. |
| V_R | = | 250V. |

4.2.3 Deviations from Burn-in and Electrical Measurements (Chart III)



- (a) Para. 7.1.1(a), High Temperature Reverse Bias Burn-in Test: Not applicable.

4.2.4 Deviations from Qualification Tests (Chart IV)

- (a) Bond Strength Test: Not applicable.
- (b) Para. 9.2.4, Die Shear: Not applicable.
- (c) Para. 9.6, Constant Acceleration: Not applicable.

4.2.5 Deviations from Lot Acceptance Tests (Chart V)

- (a) Para. 9.6, Constant Acceleration: Not applicable.

| | | |
|---|--|--------------------|
|   | ESA/SCC Detail Specification No. 5103/005 | PAGE 10 ISSUE 1 |
|---|--|--------------------|

4.3 MECHANICAL REQUIREMENTS

4.3.1 Dimension Check

The dimensions of the diodes specified herein shall be checked. They shall conform to those shown in Figure 2.

4.3.2 Weight

The maximum weight of the diodes specified herein shall be 0.17 grammes.

4.3.3 Terminal Strength

The requirements for terminal strength testing are specified in Section 9 of ESA/SCC Generic Specification No. 5000. The test conditions shall be as follows:-

Test Condition: A.
 Applied Force: 17.8 Newtons.
 Duration: 15 seconds.

4.4 MATERIALS AND FINISHES

The materials and finishes shall be as specified herein. Where a definite material is not specified, a material which will enable the diodes specified herein to meet the performance requirements of this specification shall be used. Acceptance or approval of any constituent material does not guarantee acceptance of the finished product.

4.4.1 Case

The case shall be hermetically sealed and have a glass body.

4.4.2 Lead Material and Finish

The lead material shall be either Type 'A' with Type '4' finish or Type 'O' with Type '1' finish in accordance with the requirements of ESA/SCC Basic Specification No. 23500. (See Table 1(a) for Type Variants).

4.5 MARKING

4.5.1 General

The marking of all components delivered to this specification shall be in accordance with with the requirements of ESA/SCC Basic Specification No. 21700 and the following paragraphs. When the component is too small to accommodate all of the marking specified, as much as space permits shall be marked and the marking information, in full, shall accompany the component in its primary package.

The information to be marked and the order of precedence, shall be as follows:-

- (a) Polarity.
- (b) The SCC Component Number.
- (c) Traceability Information.

4.5.2 Polarity

Polarity shall be as shown in Figures 2 and 3.

4.5.3 The SCC Component Number

Each component shall bear the SCC Component Number which shall be constituted and marked as follows:

510300502B

Detail Specification Number _____

Type Variant (See Table 1(a)) _____

Testing Level (B or C, as applicable) _____

4.5.4 Traceability Information

Each component shall be marked in respect of traceability information in accordance with the requirements of ESA/SCC Basic Specification No. 21700.

4.6 ELECTRICAL MEASUREMENTS

4.6.1 Electrical Measurements at Room Temperature

The parameters to be measured at room temperature are scheduled in Table 2. Unless otherwise stated, the measurements shall be performed at $T_{amb} = +22 \pm 3 \text{ }^\circ\text{C}$.

4.6.2 Electrical Measurements at High and Low Temperatures

The parameters to be measured at high and low temperatures are scheduled in Table 3.

4.6.3 Circuits for Electrical Measurements

Circuits for use in performing the electrical measurements listed in Tables 2 and 3 are shown, where applicable, in MIL-STD-750 and Figure 4.

4.7 BURN-IN TESTS

4.7.1 Parameter Drift Values

The parameter drift values applicable to burn-in are specified in Table 4 of this specification. Unless otherwise stated, measurements shall be performed at $T_{amb} = +22 \pm 3 \text{ }^\circ\text{C}$. The parameter drift values (Δ) applicable to the parameters scheduled, shall not be exceeded. In addition to these drift value requirements, the appropriate limit value specified for a given parameter in Table 2 shall not be exceeded.

4.7.2 Conditions for High Temperature Reverse Bias Burn-in (Table 5(a))

Not applicable.

4.7.3 Conditions for Power Burn-in

The requirements for power burn-in are specified in Section 7 of ESA/SCC Generic Specification No. 5000. The conditions for power burn-in shall be as specified in Table 5(b) of this specification.

4.7.4 Electrical Circuits for High Temperature Reverse Bias Burn-in (Figure 5(a))

Not applicable.

4.7.5 Electrical Circuits for Power Burn-in (Figure 5(b))

Not applicable.

TABLE 2 - ELECTRICAL MEASUREMENTS AT ROOM TEMPERATURE - d.c. PARAMETERS

| No. | CHARACTERISTICS | SYMBOL | MIL-STD-750 TEST METHOD | TEST CONDITIONS | LIMITS | | UNIT |
|-----|-----------------|--------|-------------------------------|--------------------------|--------|------|---------|
| | | | | | MIN. | MAX. | |
| 1 | Reverse Current | I_R | 4016 | $V_R = -250V$ | - | 3.0 | μA |
| 2 | Forward Voltage | V_F | 4011 | $I_F = 1.0A$ (Note 1) | - | 1.0 | V |
| 3 | Reverse Voltage | V_R | 4021 | $I_R = 100\mu A$ | 270 | - | V |

NOTES

1. Voltage limit applies after current is applied for at least 1 second.

TABLE 2 - ELECTRICAL MEASUREMENTS AT ROOM TEMPERATURE - a.c. PARAMETERS

| No. | CHARACTERISTICS | SYMBOL | MIL-STD-750 TEST METHOD | TEST CONDITIONS | LIMITS | | UNIT |
|-----|-----------------------|----------|-------------------------------|---|--------|------|------|
| | | | | | MIN. | MAX. | |
| 4 | Junction Capacitance | C_J | 4001 | $V_R = -10V$ $f = 1.0MHz$ | - | 65 | pF |
| 5 | Reverse Recovery Time | t_{rr} | 4031 | $I_F = 10mA$ $I_R = -10mA$ $I_{RR} = 5.0mA$ (Note 1) | - | 75 | ns |

NOTES

1. Test Circuit Figure 4.

TABLE 3 - ELECTRICAL MEASUREMENTS AT HIGH AND LOW TEMPERATURES

| No. | CHARACTERISTICS | SYMBOL | MIL-STD-750 TEST METHOD | TEST CONDITIONS | LIMITS | | UNIT |
|-----|-----------------|--------|-------------------------------|--|--------|------|---------|
| | | | | | MIN. | MAX. | |
| 1 | Reverse Current | I_R | 4016 | $V_R = -250V$ $T_{amb} = +100(+0-5) ^\circ C$ (Note 1) | - | 50 | μA |

NOTES

1. Measurement at low temperature: Not applicable.



FIGURE 4 - CIRCUITS FOR ELECTRICAL MEASUREMENT

REVERSE RECOVERY TIME

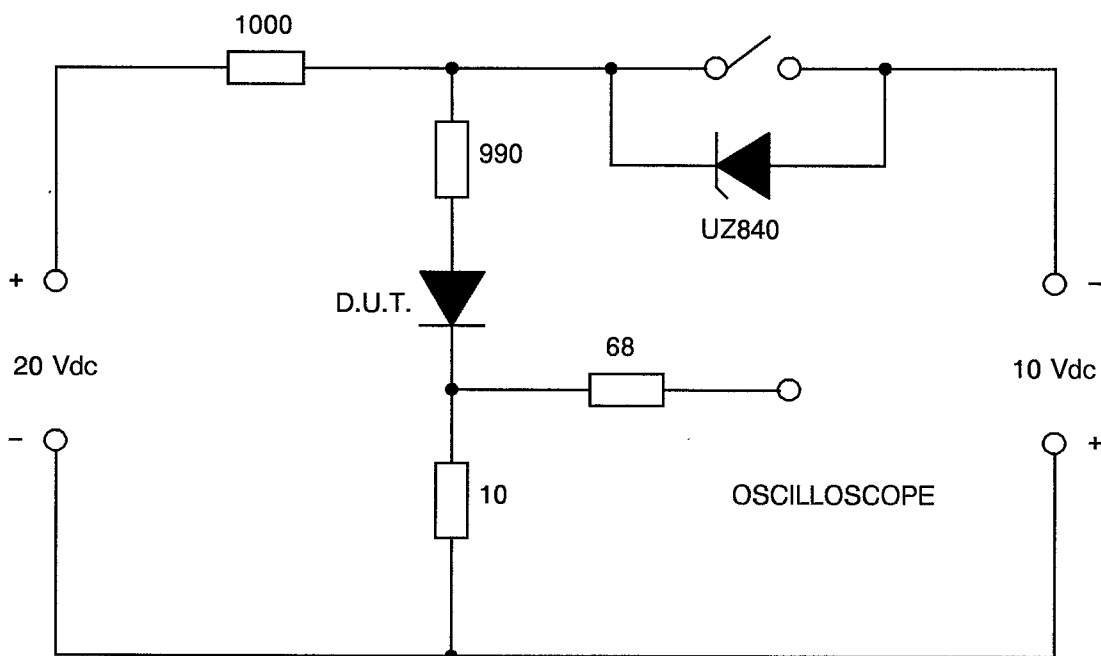

NOTES

1. All resistance values are nominal and in Ohms.

TABLE 4 - PARAMETER DRIFT VALUES

| No. | CHARACTERISTICS | SYMBOL | SPEC. AND/OR TEST METHOD | TEST CONDITIONS | CHANGE LIMIT (Δ) | UNIT |
|-----|-----------------|--------|--------------------------|-----------------|----------------------------|--------------|
| 1 | Reverse Current | I_R | As per Table 2 | As per Table 2 | 0.5 or (1) ± 100 | μA % |
| 2 | Forward Voltage | V_F | As per Table 2 | As per Table 2 | 50 | mV |

NOTES

1. Whichever is greater with respect to the initial value.

TABLE 5(a) - CONDITIONS FOR HIGH TEMPERATURE REVERSE BIAS BURN-IN

Not applicable.

TABLE 5(b) - CONDITIONS FOR POWER BURN-IN AND OPERATING LIFE TESTS

| No. | CHARACTERISTICS | SYMBOL | CONDITION | UNIT |
|-----|----------------------------------|-----------|-------------|-----------|
| 1 | Ambient Temperature | T_{amb} | + 100(± 3) | °C |
| 2 | Working Peak Reverse Voltage | V_{RWM} | 150 | V_{RMS} |
| 3 | Frequency | f | 50 or 60 | Hz |
| 4 | Average Output Rectified Current | I_o | 500 | mA |
| 5 | Test Method 1038 of MIL-STD-750 | - | A | - |

FIGURE 5(a) - ELECTRICAL CIRCUIT FOR HIGH TEMPERATURE REVERSE BIAS BURN-IN

Not applicable.

FIGURE 5(b) - ELECTRICAL CIRCUIT FOR POWER BURN-IN AND OPERATING LIFE TESTS

Not applicable.

4.8 ENVIRONMENTAL AND ENDURANCE TESTS (CHARTS IV AND V OF ESA/SCC GENERIC SPECIFICATION NO. 5000)

4.8.1 Electrical Measurements on Completion of Environmental Tests

The parameters to be measured on completion of environmental tests are scheduled in Table 2. Unless otherwise stated, the measurements shall be performed at $T_{amb} = +22 \pm 3$ °C.

4.8.2 Electrical Measurements at Intermediate Points and on Completion of Endurance Tests

The parameters to be measured at intermediate points and on completion of endurance tests are scheduled in Table 6 of this specification. Unless otherwise stated, the measurements shall be performed at $T_{amb} = +22 \pm 3$ °C.

4.8.3 Conditions for Operating Life Tests (Part of Endurance Testing)

The requirements for operating life testing are specified in Section 9 of ESA/SCC Generic Specification No. 5000. The conditions for operating life testing shall be the same as specified in Table 5(b) for the power burn-in.

4.8.4 Electrical Circuits for Operating Life Tests (Figure 5(b))

Not applicable.

4.8.5 Conditions for High Temperature Storage Test (Part of Endurance Testing)

The requirements for the high temperature storage test are specified in Section 9 of ESA/SCC Generic Specification No. 5000. The temperature to be applied shall be the maximum storage temperature specified in Table 1(b) of this specification.

TABLE 6 - ELECTRICAL MEASUREMENTS AT INTERMEDIATE POINTS AND ON COMPLETION OF ENDURANCE TESTING

| No. | CHARACTERISTICS | SYMBOL | SPEC. AND/OR TEST METHOD | TEST CONDITIONS | LIMITS | | UNIT |
|-----|-----------------------|----------|--------------------------|-----------------|--------|------|---------|
| | | | | | MIN. | MAX. | |
| 1 | Reverse Current | I_R | As per Table 2 | As per Table 2 | - | 3.0 | μA |
| 2 | Forward Voltage | V_F | As per Table 2 | As per Table 2 | - | 1.0 | V |
| 5 | Reverse Recovery Time | t_{rr} | As per Table 2 | As per Table 2 | - | 75 | ns |