



european space agency
agence spatiale européenne

Pages 1 to 17

DIODES, SILICON, FAST RECOVERY RECTIFIER

(LOW FORWARD VOLTAGE DROP),

BASED ON SERIES BYW77

ESA/SCC Detail Specification No. 5103/013



**space components
coordination group**

Issue/Rev.	Date	Approved by	
		SCCG Chairman	ESA Director General or his Deputy
Issue 2	July 1981	-	-
Revision 'A'	November 1986	-	
Revision 'B'	July 1993	<i>P. Romanus</i>	<i>F. Lat</i>

**ESCC**

ESA/SCC Detail Specification
No. 5103/013

Rev. 'B'

PAGE 2

ISSUE 2

DOCUMENTATION CHANGE NOTICE

Rev. Letter	Rev. Date	Reference	CHANGE Item	Approved DCR No.
		<p>This issue supersedes Issue 1 and incorporates all modifications agreed on the basis of the following DCR's:-</p> <p>Reference to Appendices</p> <p>Table 1(a) : V_{RRM} values amended</p> <p>Table 1(a) : Variant 01: V_{RSM} value amended</p> <p>Para. 4.1 : Reference to Appendices</p> <p>Para. 4.2.3 : Modified to read: HTRB shall be performed</p> <p>Table 2 : I_R limit changed to 25μA maximum</p> <p>Table 2 : t_{rr} unit column amended</p> <p>Table 3 : limit amended</p> <p>Table 6 : I_R limit changed to 25μA maximum</p>		<p>21019</p> <p>22095</p> <p>22095</p> <p>21019</p> <p>22095</p> <p>22095</p> <p>22095</p> <p>22095</p>
'A'	Nov. '86	<p>P1. Cover Page</p> <p>P2. DCN</p> <p>P4. T of C : Appendix A for Thomson-CSF added</p> <p>P17. Appendix A : New page</p>		<p>None</p> <p>None</p> <p>24040</p> <p>24040</p>
'B'	July '93	<p>P1. Cover Page</p> <p>P2. DCN</p> <p>P6. Table 1(a) : "Lead Material and/or Finish" column added</p> <p>P9. Para. 4.2.2 : PIND deviation amended</p> <p>Para. 4.2.3 : H.T.R.B. deviation deleted</p> <p>P10. Para. 4.4.2 : Paragraph amended</p>		<p>None</p> <p>None</p> <p>21025</p> <p>21043</p> <p>23499</p> <p>21025</p>
		<p>This document has been transferred from hardcopy to electronic format. The content is unchanged but minor differences in presentation exist.</p>		



TABLE OF CONTENTS

	<u>Page</u>
1. <u>GENERAL</u>	5
1.1 Scope	5
1.2 Component Type Variants	5
1.3 Maximum Ratings	5
1.4 Parameter Derating Information	5
1.5 Physical Dimensions	5
1.6 Functional Diagram	5
2. <u>APPLICABLE DOCUMENTS</u>	9
3. <u>TERMS, DEFINITIONS, ABBREVIATIONS, SYMBOLS AND UNITS</u>	9
4. <u>REQUIREMENTS</u>	9
4.1 General	9
4.2 Deviations from Generic Specification	9
4.2.1 Deviations from Special In-process Controls	9
4.2.2 Deviations from Final Production Tests (Chart II)	9
4.2.3 Deviations from Burn-in and Electrical Measurements (Chart III)	9
4.2.4 Deviations from Qualification Tests (Chart IV)	9
4.2.5 Deviations from Lot Acceptance Tests (Chart V)	9
4.3 Mechanical Requirements	10
4.3.1 Dimension Check	10
4.3.2 Weight	10
4.3.3 Terminal Strength	10
4.4 Materials and Finishes	10
4.4.1 Case	10
4.4.2 Lead Material and Finish	10
4.5 Marking	11
4.5.1 General	11
4.5.2 Lead Identification	11
4.5.3 The SCC Component Number	11
4.5.4 Traceability Information	11
4.5.5 Marking of Small Components	11



	<u>Page</u>	
4.6	Electrical Measurements	12
4.6.1	Electrical Measurements at Room Temperature	12
4.6.2	Electrical Measurements at High and Low Temperatures	12
4.6.3	Circuits for Electrical Measurements	12
4.7	Burn-in Tests	12
4.7.1	Parameter Drift Values	12
4.7.2	Conditions for Burn-in	12
4.7.3	Electrical Circuits for Burn-in	12
4.7.4	Conditions and Electrical Circuits for HTRB	12
4.8	Environmental and Endurance Tests	15
4.8.1	Electrical Measurements on Completion of Environmental Tests	15
4.8.2	Electrical Measurements at Intermediate Points and on Completion of Endurance Tests	15
4.8.3	Conditions for Operating Life Tests (Part of Endurance Testing)	15
4.8.4	Electrical Circuits for Operating Life Tests	15
4.8.5	Conditions for High Temperature Storage Test (Part of Endurance Testing)	15

TABLES

1(a)	Type Variants	6
1(b)	Maximum Ratings	6
2	Electrical Measurements at Room Temperature (d.c. and a.c. Parameters)	13
3	Electrical Measurements at High and Low Temperatures	14
4	Parameter Drift Values	14
5(a)	Conditions for Burn-in - Reverse Bias	14
5(b)	Conditions for Operating Burn-in	14
6	Electrical Measurements at Intermediate Points and on Completion of Endurance Testing	16

FIGURES

1	Parameter Derating Information	7
2)	Physical Dimensions	8
3	Functional Diagram	8
4	Test Circuits	13
5	Electrical Circuit for HTRB and Burn-in	N.A.

APPENDICES (Applicable to specific Manufacturers only)

'A'	Agreed Deviations for Thomson-CSF (F)	17
-----	---------------------------------------	----

**1. GENERAL****1.1 SCOPE**

This specification details the ratings, physical and electrical characteristics, test and inspection data for Diodes, Fast Recovery Rectifier, Low Forward Voltage Drop, based on Series BYW77.

It shall be read in conjunction with ESA/SCC Generic Specification No. 5000, the requirements of which are supplemented herein.

1.2 COMPONENT TYPE VARIANTS

Variants of the basic diodes specified herein, which are also covered by this specification, are listed in Table 1(a).

1.3 MAXIMUM RATINGS

The maximum ratings, which shall not be exceeded at any time during use or storage, applicable to the diodes specified herein, are scheduled in Table 1(b).

1.4 PARAMETER DERATING INFORMATION

The derating information applicable to the diodes specified herein is shown in Figure 1.

1.5 PHYSICAL DIMENSIONS

The physical dimensions of the diodes specified herein are shown in Figure 2.

1.6 FUNCTIONAL DIAGRAM

The functional diagram, showing lead identification, of the diodes specified herein, is shown in Figure 3.

**TABLE 1(a) - COMPONENT TYPE VARIANTS**

(1) VARIANT	(2) BASED ON TYPE	(3) V_R (V)	(4) V_{RWM} (V)	(5) V_{RRM} (V)	(6) V_{RSM} (V)	(7) Lead Material and Finish
01	BYW 77 - 50	50	50	50	55	3 or 4
02	BYW 77 - 100	100	100	100	110	3 or 4
03	BYW 77 - 150	150	150	150	165	3 or 4
04	BYW 77 - 200	200	200	200	220	3 or 4

TABLE 1(b) - MAXIMUM RATINGS

No.	CHARACTERISTIC	SYMBOL	MAXIMUM RATING	UNIT	REMARKS
1	Surge Forward Current	I_{FSM}	500	A	$T_{(vj)} = +150^{\circ}\text{C}$
2	Operating Temperature Range	T_{op}	-40 to +150	$^{\circ}\text{C}$	T_{amb}
3	Storage Temperature Range	T_{stg}	-65 to +175	$^{\circ}\text{C}$	
4	Soldering Temperature	T_{sol}	+260	$^{\circ}\text{C}$	Time: $\leq 10\text{s}$ Distance from case: $\geq 1.5\text{mm}$
5	Average Forward Current	I_o	20	A	$T_{case} = +122^{\circ}\text{C}$



FIGURE 1 - PARAMETER DERATING INFORMATION

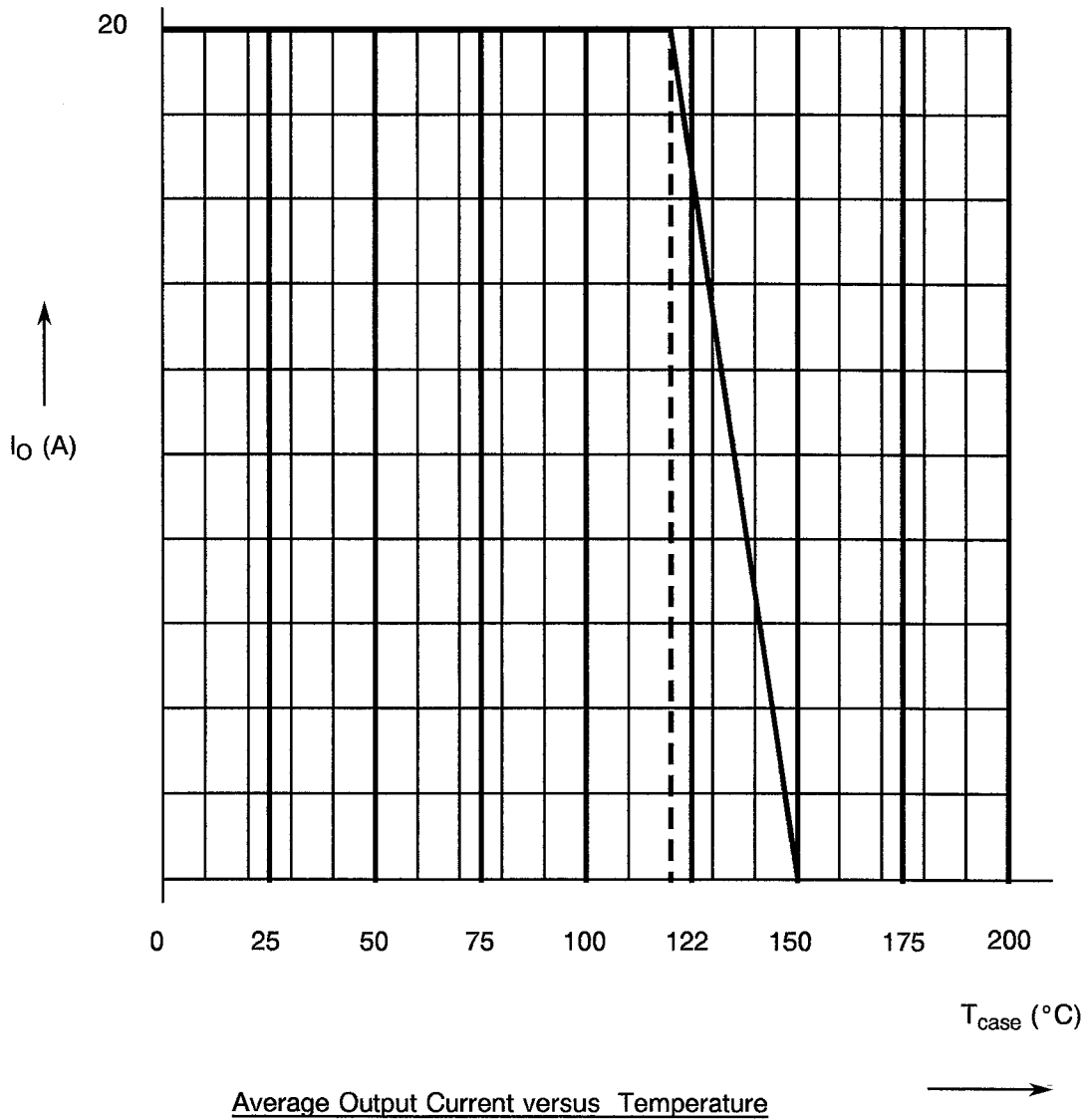
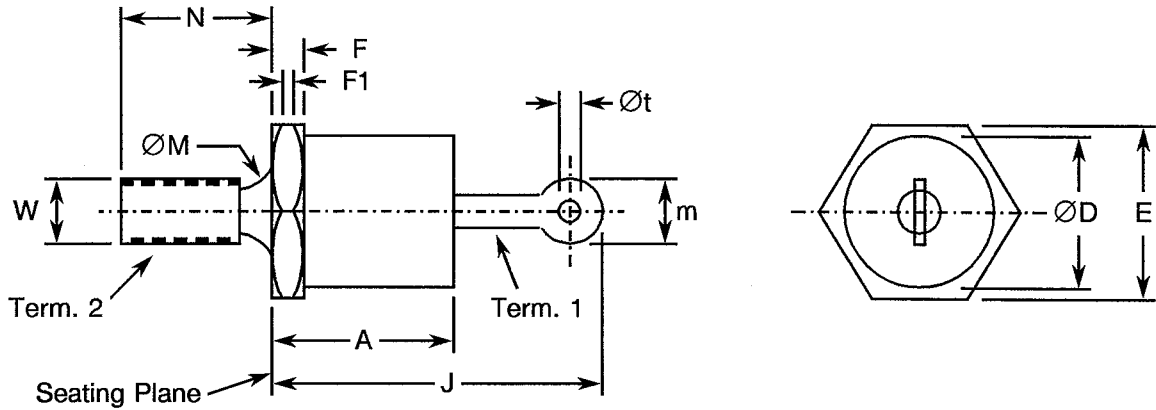



FIGURE 2 - PHYSICAL DIMENSIONS



SYMBOL	INCHES		MILLIMETRES		NOTES
	MIN.	MAX.	MIN.	MAX.	
A	-	0.405	-	10.29	
ØD	-	0.424	-	10.77	
E	0.424	0.437	10.77	11.10	
F	0.075	0.175	1.91	4.45	
F1	0.060	-	1.52	-	
J	-	0.800	-	20.32	
ØM	0.163	0.189	4.14	4.80	1
m	-	0.250	-	6.35	2
N	0.422	0.453	10.72	11.51	
Øt	0.060	-	1.52	-	
W	-	-	-	-	3

NOTES

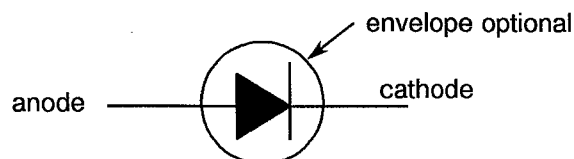

1. Complete threads to extend to within 2-1/2 thread of seating plane.
2. Angular orientation of this terminal is undefined.
3. 10-32 UNF-2A maximum pitch diameter of plated threads shall be basic pitch diameter (0.16697", 4.29mm) ref. (Screw thread standards for Federal Services 1957) Handbook H28 P1.

FIGURE 3 - FUNCTIONAL DIAGRAM



NOTES

1. The cathode is connected to the stud.

		<p style="text-align: center;">ESA/SCC Detail Specification No. 5103/013</p>	<p style="text-align: center;">Rev. 'B'</p>	<p>PAGE 9 ISSUE 2</p>
--	--	--	---	---------------------------

2. APPLICABLE DOCUMENTS

The following documents form part of this specification and shall be read in conjunction with it:-

- (a) ESA/SCC Generic Specification No. 5000 for Discrete Semiconductors.
- (b) MIL-STD-750, Test Methods and Procedures for Semiconductor Devices.

3. TERMS, DEFINITIONS, ABBREVIATIONS, SYMBOLS AND UNITS

For the purpose of this specification, the terms, definitions, abbreviations, symbols and units specified in ESA/SCC Basic Specification No. 21300 shall apply.

4. REQUIREMENTS

4.1 GENERAL

The complete requirements for procurement of the diodes specified herein are stated in this specification and ESA/SCC Generic Specification No. 5000 for Discrete Semiconductors. Deviations from the Generic Specification applicable to this specification only, are listed in Para. 4.2.

Deviations from the applicable Generic Specification and this Detail Specification, formally agreed with specific Manufacturers on the basis that the alternative requirements are equivalent to the ESA/SCC requirements and do not affect the components' reliability, are listed in the appendices attached to this specification.

4.2 DEVIATIONS FROM GENERIC SPECIFICATION

4.2.1 Deviations from Special In-process Controls

None.

4.2.2 Deviations from Final Production Tests (Chart II)

- (a) Para. 9.2.1, Bond Strength Test: Shall not be performed.
- (b) Para. 9.7, Particle Impact Noise Detection (PIND) Test: Not applicable.
- (c) Para. 9.5, Thermal Shock Test: To be performed in accordance with MIL-STD-202, Test Method 107, Test Condition 'B'.

4.2.3 Deviations from Burn-in and Electrical Measurements (Chart III)

None.

4.2.4 Deviations from Qualification Tests (Chart IV)

- (a) The Bond Strength Test (Subgroup III): Not required.

4.2.5 Deviations from Lot Acceptance Tests (Chart V)

None.



4.3 MECHANICAL REQUIREMENTS

4.3.1 Dimension Check

The dimensions of the diodes specified herein shall be checked. They shall conform to those shown in Figure 2.

4.3.2 Weight

The maximum weight of the diodes specified herein shall be 7.0 grammes.

4.3.3 Terminal Strength

The requirements for terminal strength testing are specified in Section 9 of ESA/SCC Generic Specification No. 5000. The test conditions shall be as follows:-

Test Condition : 'A'.
Applied Force : 20 Newtons.
Duration : 10 seconds.

4.4 MATERIALS AND FINISHES

The materials and finishes shall be as specified herein. Where a definite material is not specified, a material which will enable the diodes specified herein to meet the performance requirements of this specification shall be used. Acceptance or approval of any constituent material does not guarantee acceptance of the finished product.

4.4.1 Case

Metal, hermetically sealed.

4.4.2 Lead Material and Finish

The finish shall be Type '3 or 4' in accordance with the requirements of ESA/SCC Basic Specification No. 23500 (See Table 1(a) for Type Variants).



4.5 MARKING

4.5.1 General

The marking of all components delivered to this specification shall be in accordance with the requirements of ESA/SCC Basic Specification No. 21700. Each component shall be marked in respect of:-

- (a) Lead Identification.
- (b) The SCC Component Number.
- (c) Traceability Information.

4.5.2 Lead Identification

Lead identification shall be as shown in Figures 2 and 3.

4.5.3 The SCC Component Number

Each component shall bear the SCC Component Number which shall be constituted and marked as follows:

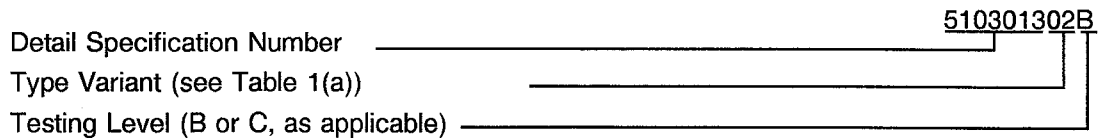

4.5.4 Traceability Information

Each component shall be marked in respect of traceability information in accordance with the requirements of ESA/SCC Basic Specification No. 21700.

4.5.5 Marking of Small Components

When it is considered that the component is too small to accommodate the marking as specified above, as much as space permits shall be marked. The order of precedence shall be as follows:-

- (a) Lead Identification.
- (b) The SCC Component Number.
- (c) Traceability Information.

The marking information in full shall accompany each component in its primary package.



4.6 ELECTRICAL MEASUREMENTS

4.6.1 Electrical Measurements at Room Temperature

The parameters to be measured at room temperature are scheduled in Table 2. The measurements shall be performed at $T_{amb} = +22 \pm 3$ °C.

4.6.2 Electrical Measurements at High and Low Temperatures

The parameters to be measured at high and low temperatures are scheduled in Table 3.

4.6.3 Circuits for Electrical Measurements

Circuits for use in performing the electrical measurements listed in Tables 2 and 3 are shown in Figure 4.

4.7 BURN-IN TESTS

4.7.1 Parameter Drift Values

The parameter drift values applicable to burn-in are specified in Table 4 of this specification. Unless otherwise stated, the measurements shall be performed at $T_{amb} = +22 \pm 3$ °C. The parameter drift values (Δ) applicable to the parameters scheduled, shall not be exceeded. In addition to these drift value requirements, the appropriate limit value specified for a given parameter in Table 2 shall not be exceeded.

4.7.2 Conditions for Burn-in

The requirements for burn-in are specified in Section 7 of ESA/SCC Generic Specification No. 5000. The conditions for burn-in shall be as shown in Table 5(b) of this specification.

4.7.3 Electrical Circuits for Burn-in

Circuits for use in performing the burn-in tests are shown in Figure 5 of this specification.

4.7.4 Conditions and Electrical Circuits for High Temperature Reverse Bias

The requirements for the High Temperature Reverse Bias test are specified in Section 7 of ESA/SCC Generic Specification No. 5000. The conditions shall be as specified in Table 5(a), the electrical circuits to be used are shown in Figure 5 of this specification.



TABLE 2 - ELECTRICAL MEASUREMENTS AT ROOM TEMPERATURE - d.c. PARAMETERS

No.	CHARACTERISTICS	SYMBOL	SPEC AND/OR TEST METHOD	TEST CONDITION	LIMITS		UNIT
					MIN.	MAX.	
1	Reverse Current	I_R	MIL-STD-750, Method 4016	$V_R = (1)$	-	25	μA
2	Forward Voltage	V_{F1}	MIL-STD-750, Method 4011	$I_{F1} = 5.0A (2)$	-	0.8	V
		V_{F2}		$I_{F2} = 20A (2)$	-	0.95	

NOTES

1. See Column 3 of Table 1(a).
2. Pulse Measurement: Pulse length $\leq 300\mu s$; Duty Cycle $\leq 2\%$.

(a.c. PARAMETERS)

No.	CHARACTERISTICS	SYMBOL	SPEC AND/OR TEST METHOD	TEST CONDITION	LIMITS		UNIT
					MIN.	MAX.	
1	Reverse Recovery Time	t_{rr}	MIL-STD-750, Method 4031, Cond. 'B'	$I_F = 1.0A$ $dI_F/dt = -50A/\mu s$ $I_{RR} = 0.2I_{RM}$ $V_R = 30V$ See Figure 4	-	50	ns

FIGURE 4 - TEST CIRCUITS

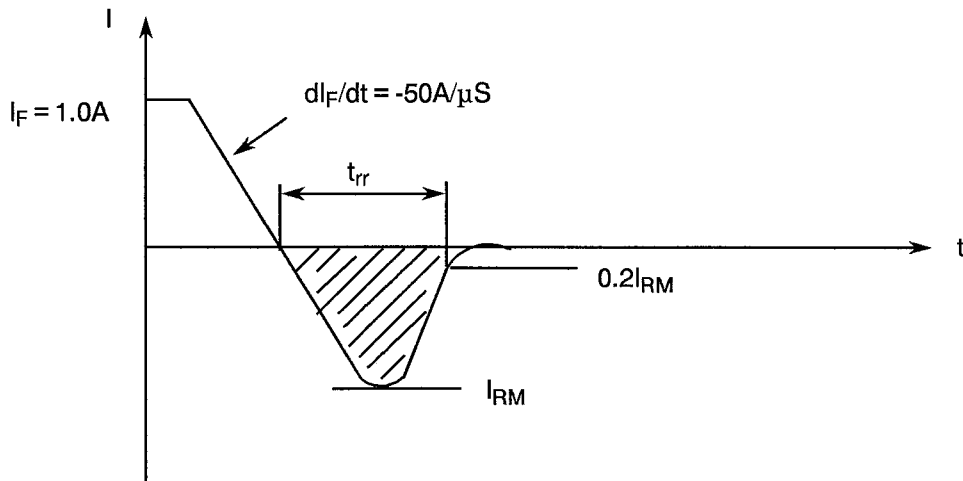

**TABLE 3 - ELECTRICAL MEASUREMENTS AT HIGH AND LOW TEMPERATURES**

No.	CHARACTERISTICS	SYMBOL	SPEC. AND/OR TEST METHOD	TEST CONDITIONS	LIMITS		UNIT
					MIN.	MAX.	
1	Reverse Current	I_R	MIL-STD-750 Method 4016	$T_{amb} = +100\text{ }^\circ\text{C}$ $V_R = (1)\text{ V}$	-	2.5	mA

NOTES

- See Column 3 of Table 1(a).

TABLE 4 - PARAMETER DRIFT VALUES

No.	CHARACTERISTICS	SYMBOL	SPEC. AND/OR TEST METHOD	TEST CONDITION	CHANGE LIMITS (Δ)	UNIT
1	Forward Voltage	V_F	MIL-STD-750 Method 4011	$I_F = I_O = 20\text{A}$	± 100	mV
2	Reverse Current	I_R	MIL-STD-750 Method 4016	$V_R = (1)\text{ V}$	100 or 2.0	% μA

NOTES

- See Column 3 of Table 1(a).

TABLE 5(a) - CONDITIONS FOR BURN-IN - REVERSE BIAS

No.	CHARACTERISTICS	SYMBOL	CONDITION	UNIT
1	Case Temperature	T_{case}	+125	$^\circ\text{C}$
2	Reverse Voltage	V_R	$0.8V_R (1)$	V

NOTES



- See Column 3 of Table 1(a). Duration of HTRB shall be 72 hours.

TABLE 5(b) - CONDITIONS FOR OPERATING BURN-IN

No.	CHARACTERISTICS	SYMBOL	CONDITION	UNIT
1	Case Temperature	T_{case}	+100	$^\circ\text{C}$
2	Reverse Current	I_F	20	A

FIGURE 5 - ELECTRICAL CIRCUITS FOR HTRB AND BURN-IN

Not applicable.

 	ESA/SCC Detail Specification No. 5103/013		PAGE 15 ISSUE 2
---	--	--	--------------------

4.8 ENVIRONMENTAL AND ENDURANCE TESTS (CHARTS IV AND V OF ESA/SCC GENERIC SPECIFICATION NO. 5000)

4.8.1 Electrical Measurements on Completion of Environmental Tests

The parameters to be measured on completion of environmental tests are scheduled in Table 2. The measurements shall be performed at $T_{amb} = +22 \pm 3 \text{ }^\circ\text{C}$.

4.8.2 Electrical Measurements at Intermediate Points and on Completion of Endurance Tests

The parameters to be measured at intermediate points and on completion of endurance testing are scheduled in Table 6.

4.8.3 Conditions for Operating Life Tests (Part of Endurance Testing)

The requirements for operating life testing are specified in Section 9 of ESA/SCC Generic Specification No. 5000. The conditions for operating life testing shall be the same as specified in Table 5(b) for the burn-in test.

4.8.4 Electrical Circuits for Operating Life Test

The circuit to be used for performance of the operating life tests shall be the same as shown in Figure 5 for burn-in.

4.8.5 Conditions for High Temperature Storage Test (Part of Endurance Testing)

The requirements for the high temperature storage test are specified in ESA/SCC Generic Specification No. 5000. The temperature to be applied shall be the maximum storage temperature specified in Table 1(b) of this specification.

**SCC**ESA/SCC Detail Specification
No. 5103/013

PAGE 16

ISSUE 2

**TABLE 6 - ELECTRICAL MEASUREMENTS AT INTERMEDIATE POINTS AND ON
COMPLETION OF ENDURANCE TESTING**

No.	CHARACTERISTICS	SYMBOL	SPEC. AND/OR TEST METHOD	TEST CONDITION	LIMITS		UNIT
					MIN.	MAX.	
1	Forward Voltage	V_{F2}	MIL-STD-750, Method 4011	$I_F = I_o = 20A$	-	0.95	V
2	Reverse Current	I_R	MIL-STD-750, Method 4016	$V_R = (1) V$	-	25	μA

NOTES

1. See Column 3 of Table 1(a).

**SCC**ESA/SCC Detail Specification
No. 5103/013

Rev. 'A'

PAGE 17

ISSUE 2

APPENDIX 'A'Page 1 of 1**AGREED DEVIATIONS FOR THOMSON-CSF (F)**

ITEMS AFFECTED	DESCRIPTION OF DEVIATIONS
Para. 4.2.4) Para. 4.2.5)	Deviations from Environmental and Endurance Tests (Chart IV) and from Lot Acceptance Tests (Chart V). "Moisture Resistance", Para. 9.16, according to MIL-STD-750, Method 1021, shall be replaced by:- "Climatic Sequence" according to IEC Publication No. 68-1; Applicable condition: Phase 'D': Option 2, 5 cycles. Phase 'F' (Low Air Pressure): Not applicable.