



**europaean space agency
agence spatiale européenne**

Pages 1 to 19

**DIODES, SILICON, POWER RECTIFIER,
FAST RECOVERY,
BASED ON TYPES 1N5614, 1N5616, 1N5618,
1N5620, 1N5622, 1N5614US, 1N5616US, 1N5618US,
1N5620US AND 1N5622US**

ESA/SCC Detail Specification No. 5103/024



**space components
coordination group**

Issue/Rev.	Date	Approved by	
		SCCG Chairman	ESA Director General or his Deputy
Issue 2	November 1998		



DOCUMENTATION CHANGE NOTICE

Rev. Letter	Rev. Date	Reference	CHANGE Item	Approved DCR No.
		This Issue supersedes Issue 1 and incorporates all modifications defined in Revision 'A' to Issue 1 and the changes agreed in the following DCRs:-		
		Cover Page	: Title amended to include new part types	221505
		DCN		None
		Para. 1.1	: First sentence amended to include new part types	221505
		Para. 1.7	: New paragraph added	221505
		Para. 1.8	: New paragraph added	221505
		Table 1(a)	: Table restructured	221505
			: Variants 11 to 15 added	221505
		Table 1(b)	: No. 1, Remarks amended	221505
			: No. 2, Renumbered as "3" and amended	221505
			: , New No. 2 added	221505
			: No. 3, Renumbered as "4"	221505
			: No. 4, Renumbered as "5" and Maximum Ratings amended	221505
			: No. 5, Renumbered as "6", Maximum Ratings expanded and Remarks amended	221505
			: Nos. 7 and 8, New Items added	221505
			: Note 1 renumbered as "6" and Note 2 deleted	221505
			: New Notes 1 to 5 and 7 and 8 added	221505
		Figure 1	: Title and Graph amended	221505
		Figure 2(a)	: Title amended	221505
			: Existing Figure deleted and new Figure added	221505
			: In the Table, Dimensions "G" and "L" amended	221505
			: Notes added	221505
		Figure 2(b)	: Title amended and parenthesised information deleted from Notes heading	221505
		Figure 2(c)	: New Figure added	221505
		Figure 3	: Note amended	221505
		Para. 4.2.2	: Deviation (c) deleted and new Deviation added	221505
			: Deviation (f) amended	221505
			: New Deviations (g) and (h) added	221505
		Para. 4.2.3	: Existing Deviation (a) deleted and new Deviation added	221505
			: Deviation (b) amended	221505
			: New Deviation (c) added	221505
		Para. 4.2.4	: Deviation (d) renumbered as "(c)" and amended	221505
			: Deviation (c) renumbered as "(d)"	221505
		Para. 4.2.5	: Deviation (a) renumbered as "(b)"	221505
			: Deviation (b) renumbered as "(a)" and amended	221505
		Para. 4.3.2	: Existing text deleted and new text added	221505
		Para. 4.3.3	: "For Variants 01 to 10," added at the beginning of the second sentence	221505
		Para. 4.4.2	: Existing text deleted and new text added	221505
		Para. 4.5.1	: Existing text deleted and new text added	221505
		Para. 4.5.2	: Title and text amended to "Polarity"	221505
		Para. 4.5.5	: Deleted in toto	221505
		Para. 4.7.2	: Existing paragraph renumbered to "4.7.3" and second sentence amended	221505
			: New paragraph added	221505

**DOCUMENTATION CHANGE NOTICE**

Rev. Letter	Rev. Date	Reference	CHANGE Item	Approved DCR No.	
		Para. 4.7.3	: Renumbered to "4.7.5" and Title amended	221505	
		Para. 4.7.4	: New paragraph entry added	221505	
		Table 2 d.c.	: No. 1, Renumbered to "2" and Test Conditions amended	221505	
			: No. 2, Renumbered to "1" and Test Conditions amended	221505	
			: Note 1 renumbered as "2" and "3" amended to "6"	221505	
			: Note 2 renumbered as "1"	221505	
			: In Note 3, "7" amended to "5"	221505	
			Table 2 a.c.	: No. 4, Test Conditions amended	221505
				: No. 5, "(Note 1)" added to Test Conditions	221505
		: No. 6, New Item added		221505	
		Table 3	: Existing Note numbered as "1" and amended	221505	
			: New Note 2 added	221505	
			: No. 1, Renumbered as "2" and Test Conditions amended	221505	
		Table 4	: In Note 1, "3" amended to "6"	221505	
			: No. 1, Renumbered as "2", No. 2, renumbered as "1" and the tests reversed in sequence	221505	
			: No. 2, Renumbered as "1" and tests reversed in sequence	221505	
		Table 5(a)	: New Table added	221505	
		Table 5	: Renumbered as "5(b)" and Table amended	221505	
			: Note amended	221505	
		Figure 5(a)	: New Figure entry added	221505	
		Figure 5	: Title amended to "5(b)"	221505	
		Para. 4.8.1	: "Unless otherwise stated," added at the beginning of the second sentence	221505	
		Para. 4.8.2	: "Unless otherwise stated," added at the beginning of the second sentence	221505	
		Para. 4.8.3	: In the second sentence, "5" amended to "5(b)"	221505	
		Table 6	: No. 1, Renumbered as "2" and Change Limits added	221505	
			: No. 2, Renumbered as "1", Change Limits added and then the Tests reversed in sequence	221505	
			: Note added	221505	
		Appendix 'A'	: Existing Appendix deleted and new Appendix added	221505	



	<p style="text-align: center;">ESA/SCC Detail Specification No. 5103/024</p>		<p>PAGE 3 ISSUE 2</p>
---	--	--	---------------------------

TABLE OF CONTENTS

		<u>Page</u>
1.	<u>GENERAL</u>	5
1.1	Scope	5
1.2	Component Type Variants	5
1.3	Maximum Ratings	5
1.4	Parameter Derating Information	5
1.5	Physical Dimensions	5
1.6	Functional Diagram	5
1.7	High Temperature Test Precautions	5
1.8	Handling Precautions	5
2.	<u>APPLICABLE DOCUMENTS</u>	5
3.	<u>TERMS, DEFINITIONS, ABBREVIATIONS, SYMBOLS AND UNITS</u>	5
4.	<u>REQUIREMENTS</u>	11
4.1	General	11
4.2	Deviations from Generic Specification	11
4.2.1	Deviations from Special In-process Controls	11
4.2.2	Deviations from Final Production Tests	11
4.2.3	Deviations from Burn-in and Electrical Measurements	12
4.2.4	Deviations from Qualification Tests	12
4.2.5	Deviations from Lot Acceptance Tests	12
4.3	Mechanical Requirements	12
4.3.1	Dimension Check	12
4.3.2	Weight	12
4.3.3	Terminal Strength	12
4.4	Materials and Finishes	12
4.4.1	Case	12
4.4.2	Lead Material and Finish	12
4.5	Marking	13
4.5.1	General	13
4.5.2	Polarity	13
4.5.3	The SCC Component Number	13
4.5.4	Traceability Information	13
4.6	Electrical Measurements	13
4.6.1	Electrical Measurements at Room Temperature	13
4.6.2	Electrical Measurements at High and Low Temperatures	13
4.6.3	Circuits for Electrical Measurements	13
4.7	Burn-in Tests	13
4.7.1	Parameter Drift Values	13
4.7.2	Conditions for High Temperature Reverse Bias Burn-in	14
4.7.3	Conditions for Power Burn-in	14
4.7.4	Electrical Circuits for High Temperature Reverse Bias Burn-in	14
4.7.5	Electrical Circuits for Power Burn-in	14
4.8	Environmental and Endurance Tests	14
4.8.1	Electrical Measurements on Completion of Environmental Tests	18
4.8.2	Electrical Measurements at Intermediate Points and on Completion of Endurance Tests	18
4.8.3	Conditions for Operating Life Tests	18
4.8.4	Electrical Circuits for Operating Life Tests	18
4.8.5	Conditions for High Temperature Storage Test	18

		ESA/SCC Detail Specification No. 5103/024		PAGE 4 ISSUE 2
---	---	--	--	-------------------

<u>TABLES</u>		<u>Page</u>
1(a)	Type Variants	6
1(b)	Maximum Ratings	7
2	Electrical Measurements at Room Temperature - D.C. parameters	15
	Electrical Measurements at Room Temperature - A.C. parameters	15
3	Electrical Measurements at High and Low Temperatures	16
4	Parameter Drift Values	17
5(a)	Conditions for High Temperature Reverse Bias Burn-in	17
5(b)	Conditions for Power Burn-in and Operating Life Tests	17
6	Electrical Measurements at Intermediate Points and on Completion of Endurance Testing	18

<u>FIGURES</u>		
1	Parameter Derating Information	8
2	Physical Dimensions	9
3	Functional Diagram	10
4	Circuits for Electrical Measurements	16
5(a)	Electrical Circuit for High Temperature Reverse Bias Burn-in	N/A
5(b)	Electrical Circuit for Power Burn-in and Operating Life Tests	N/A

<u>APPENDICES (Applicable to specific Manufacturers only)</u>		
'A'	Agreed Deviations for Microsemi (IRL)	19

**1. GENERAL****1.1 SCOPE**

This specification details the ratings, physical and electrical characteristics, test and inspection data for Diodes, Silicon, Power Rectifier, Fast Recovery, based on Types 1N5614, 1N5616, 1N5618, 1N5620, 1N5622, 1N5614US, 1N5616US, 1N5618US, 1N5620US and 1N5622US. It shall be read in conjunction with ESA/SCC Generic Specification No. 5000, the requirements of which are supplemented herein.

1.2 COMPONENT TYPE VARIANTS

Variants of the basic diodes specified herein, which are also covered by this specification, are listed in Table 1(a).

1.3 MAXIMUM RATINGS

The maximum ratings, which shall not be exceeded at any time during use or storage, applicable to the diodes specified herein, are scheduled in Table 1(b).

1.4 PARAMETER DERATING INFORMATION

The derating information applicable to the diodes specified herein is shown in Figure 1.

1.5 PHYSICAL DIMENSIONS

The physical dimensions of the diodes specified herein are shown in Figure 2.

1.6 FUNCTIONAL DIAGRAM

The functional diagram, showing lead identification, of the diodes specified herein, is shown in Figure 3.

1.7 HIGH TEMPERATURE TEST PRECAUTIONS

For tin-lead plated or solder-dipped lead finish, all tests to be performed at a temperature that exceeds +125°C shall be carried out in 100% inert atmosphere.

1.8 HANDLING PRECAUTIONS

These devices are susceptible to damage by electrostatic discharge. Therefore, suitable precautions shall be employed for protection during all phases of manufacture, testing, packaging, shipment and any handling.

The components are categorised as Class 3 with a Minimum Critical Path Failure Voltage of > 15 000V.

2. APPLICABLE DOCUMENTS

The following documents form part of this specification and shall be read in conjunction with it:-

- (a) ESA/SCC Generic Specification No. 5000 for Discrete Semiconductors.
- (b) MIL-STD-202, Test Methods for Electronic and Electrical Component Parts.
- (c) MIL-STD-750, Test Methods and Procedures for Semiconductor Devices.

3. TERMS, DEFINITIONS, ABBREVIATIONS, SYMBOLS AND UNITS

For the purpose of this specification, the terms, definitions, abbreviations, symbols and units specified in ESA/SCC Basic Specification No. 21300 shall apply.



SCC

ESA/SCC Detail Specification

No. 5103/024

PAGE 6

ISSUE 2

TABLE 1(a) - TYPE VARIANTS

(1) VARIANT	(2) BASED ON TYPE	(3) CASE	(4) FIGURE	(5) BREAKDOWN VOLTAGE $I_R = 50\mu A$ $V_{(BR)}(V)$	(6) WORKING PEAK REVERSE VOLTAGE $V_{RWM}(V)$	(7) REVERSE RECOVERY TIME $t_{rr}(ns)$	(8) CAPACITANCE C(pF)	(9) LEAD/END-CAP MATERIAL AND FINISH
01	1N5614	A	2(a)	220	200	2.0	50	A3 or A4
02	1N5616	A	2(a)	440	400	2.0	50	A3 or A4
03	1N5618	A	2(a)	660	600	2.0	50	A3 or A4
04	1N5620	A	2(a)	880	800	2.0	50	A3 or A4
05	1N5622	A	2(a)	1100	1000	2.0	50	A3 or A4
06	1N5614	AA	2(b)	220	200	2.0	50	K3 or K4
07	1N5616	AA	2(b)	440	400	2.0	50	K3 or K4
08	1N5618	AA	2(b)	660	600	2.0	50	K3 or K4
09	1N5620	AA	2(b)	880	800	2.0	50	K3 or K4
10	1N5622	AA	2(b)	1100	1000	2.0	50	K3 or K4
11	1N5614US	MELF	2(c)	220	200	2.0	50	O4
12	1N5616US	MELF	2(c)	440	400	2.0	50	O4
13	1N5618US	MELF	2(c)	660	600	2.0	50	O4
14	1N5620US	MELF	2(c)	880	800	2.0	50	O4
15	1N5622US	MELF	2(c)	1100	1000	2.0	50	O4

**TABLE 1(b) - MAXIMUM RATINGS**

NO.	CHARACTERISTICS	SYMBOL	MAXIMUM RATINGS	UNIT	REMARKS
1	Forward Surge Current	I_{FSM}	30	A(pk)	At $T_{amb} \leq +100^{\circ}C$ $I_O = 750mA$ (Note 1)
2	Working Peak Reverse Voltage	V_{RWM}	Note 2	V(pk)	At $T_{amb} \leq +25^{\circ}C$
3	Average Output Rectified Current	I_O	1.0 (3)	A	Notes 5 and 6
			0.75 (4)		
4	Operating Temperature Range	T_{op}	- 65 to + 175	$^{\circ}C$	T_{amb}
5	Storage Temperature Range	T_{stg}	- 65 to + 175	$^{\circ}C$	
6	Soldering Temperature Variants 01 to 10 Variants 11 to 15	T_{sol}	+ 260	$^{\circ}C$	Note 7 Note 8
			+ 245		
7	Thermal Resistance (Junction to Lead)	$R_{TH(J-L)}$	38	$^{\circ}C/W$	Note 5
8	Thermal Resistance (Junction to End-Cap)	$R_{TH(J-EC)}$	7.0	$^{\circ}C/W$	

NOTES

1. Sinusoidal, with period = 8.3ms maximum.
2. See Column 6 of Table 1(a).
3. At $T_L \leq +55^{\circ}C$ for Variants 01 to 10 and $T_{EC} = +110^{\circ}C$ for Variants 11 to 15. For derating at $T_L > +55^{\circ}C$ to $T_L \leq +100^{\circ}C$ and $T_{EC} > +110^{\circ}C$, see Figure 1.
4. At $T_L = +100^{\circ}C$ for Variants 01 to 10. For derating at $T_L > +100^{\circ}C$, see Figure 1.
5. Leads shall be maintained at ambient temperature 9.53mm from the body.
6. No special mounting, heat-sinking or forced-air flow across exposed areas of the device is necessary.
7. Duration 10 seconds maximum at a distance of not less than 1.5mm from the device body and the same lead shall not be resoldered until 3 minutes have elapsed.
8. Duration 10 seconds maximum and the same termination shall not be resoldered until 3 minutes have elapsed.



FIGURE 1 - PARAMETER DERATING INFORMATION

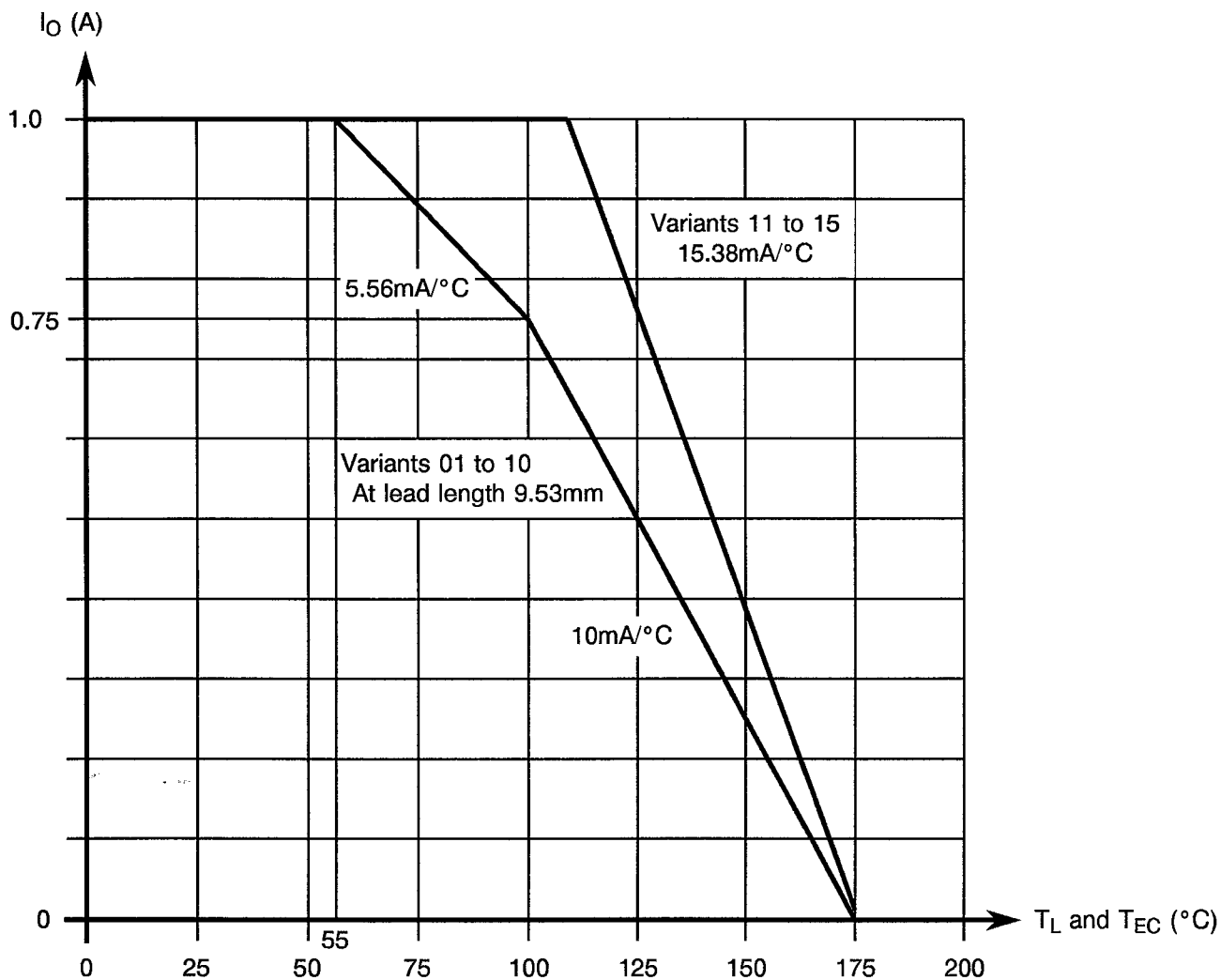

Average Output Rectified Current versus Temperature

FIGURE 2 - PHYSICAL DIMENSIONS

FIGURE 2(a) - VARIANTS 01 TO 05

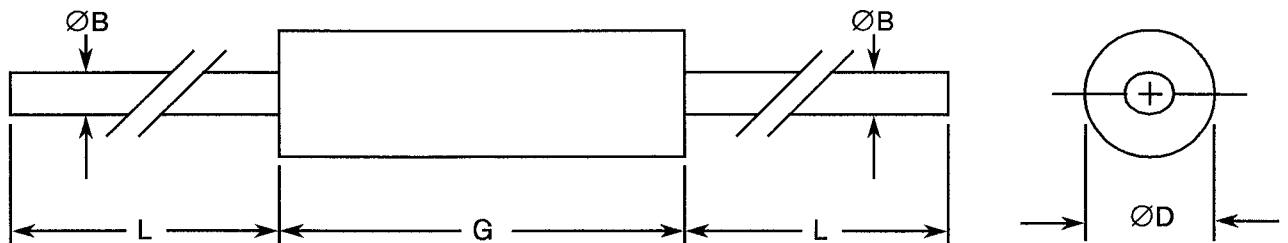

SYMBOL	MILLIMETRES		NOTES
	MIN.	MAX.	
ØB	0.66	0.84	-
ØD	1.65	2.79	1
G	3.18	6.35	2
L	17.78	33.02	-

NOTES

1. Dimension ØD shall be measured at the largest diameter.
2. Dimension G shall include the sections of the lead over which the diameter is uncontrolled. This uncontrolled area is defined as the zone between the edge of the diode body and extending 1.27mm onto the leads.

FIGURE 2(b) - VARIANTS 06 TO 10

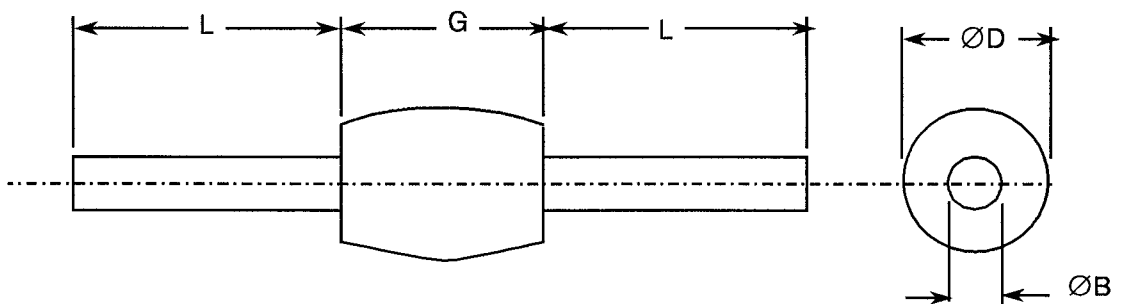

SYMBOL	MILLIMETRES		NOTES
	MIN.	MAX.	
ØB	0.75	0.85	-
ØD	2.70	3.50	1
G	3.90	4.60	2
L	25.00	31.70	-

NOTES

1. Dimension ØD shall be measured at the largest diameter.
2. The 'G' dimension shall include all uncontrolled areas of the device leads.



FIGURE 2 - PHYSICAL DIMENSIONS (CONTINUED)

FIGURE 2(c) - VARIANTS 11 TO 15

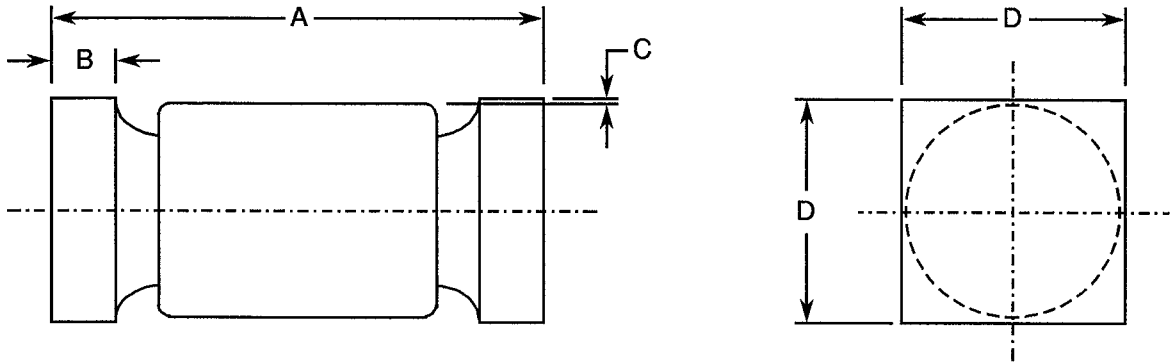

SYMBOL	MILLIMETRES	
	MIN.	MAX.
A	4.27	5.08
B	0.48	0.71
C	0.08	-
D	2.31	2.62

FIGURE 3 - FUNCTIONAL DIAGRAM

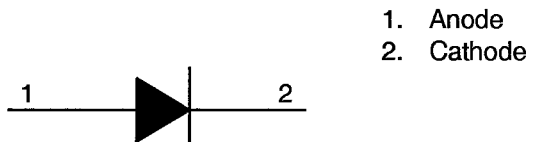

NOTES

1. For Variants 01 to 10, the cathode end shall be marked with a contrasting coloured ring.

For Variants 11 to 15, the cathode end shall be marked with a minimum of 3 contrasting coloured dots or a black band.



4. REQUIREMENTS

4.1 GENERAL

The complete requirements for procurement of the diodes specified herein are stated in this specification and ESA/SCC Generic Specification No. 5000 for Discrete Semiconductors. Deviations from the Generic Specification applicable to this specification only, are listed in Para. 4.2.

Deviations from the applicable Generic Specification and this Detail Specification, formally agreed with specific Manufacturers on the basis that the alternative requirements are equivalent to the ESA/SCC requirements and do not affect the components' reliability, are listed in the appendices attached to this specification.

4.2 DEVIATIONS FROM GENERIC SPECIFICATION

4.2.1 Deviations from Special In-process Controls

None.

4.2.2 Deviations from Final Production Tests (Chart II)

(a) Para. 9.2.1, Bond Strength Test: Not applicable.

(b) Para. 9.2.2, Die-shear Test: Not applicable.

(c) At any time following Para. 9.5.1, Thermal Shock Test, Thermal Impedance measurements shall be performed in accordance with MIL-STD-750, Test Method 3101 as specified in Table 2, Item 6 of this specification.

(d) Para. 9.6, Constant Acceleration: Not applicable.

(e) Para. 9.7, Particle Impact Noise Detection (PIND) Test: Not applicable.

(f) Para. 9.8.1, Seal Test Fine Leak: Not applicable.

(g) Immediately following Para. 9.9.3, Electrical Measurements at Room Temperature, a Surge Current test shall be performed on a sample basis, LTPD=7 or lower, in accordance with MIL-STD-750, Test Method 4066 using the following conditions:

- $I_{FSM} = 30A(pk)$.
- $I_O = 750mA$.
- $V_{RWM} = \text{See Column 6 of Table 1(a)}$.
- At $T_{amb} = +22 \pm 3 \text{ }^\circ\text{C}$.

10 surges at a rate of 1 per minute maximum and of duration 1/100 or 1/120 seconds.

Before and after Surge Current application, the sample devices shall be electronically tested in accordance with Table 6 of this specification.

(h) Immediately following the Surge Current test specified in (g) above, a "Scope-display Evaluation" shall be made of the reverse breakdown characteristics as follows:

- Display calibration: 5.0 to 20 μ A and 50 to 200V per division.
- Reverse current over the knee: 50 μ A minimum.

Each device may exhibit a sharp knee characteristic and any discontinuity or dynamic instability of the trace shall be cause for rejection.



4.2.3 Deviations from Burn-in and Electrical Measurements (Chart III)

- (a) Para. 9.9.5, Safe Operating Area: Not applicable.
- (b) Para. 9.8.1, Seal Test Fine Leak: Not applicable.
- (c) Para. 9.12, Radiographic Inspection: Not applicable.

4.2.4 Deviations from Qualification Tests (Chart IV)

- (a) Para. 9.2.3, Bond Strength Test: Not applicable.
- (b) Para. 9.2.4, Die-shear Test: Not applicable.
- (c) Para. 9.8.1, Seal Test Fine Leak: Not applicable.
- (d) Para. 9.15, Constant Acceleration: Not applicable.

4.2.5 Deviations from Lot Acceptance Tests (Chart V)

- (a) Para. 9.8.1, Seal Test Fine Leak: Not applicable.
- (b) Para. 9.15, Constant Acceleration: Not applicable.

4.3 MECHANICAL REQUIREMENTS

4.3.1 Dimension Check

The dimensions of the diodes specified herein shall be checked. They shall conform to those shown in Figure 2.

4.3.2 Weight

The maximum weight of the diodes specified herein shall be 0.4 grammes for Variants 01 to 05, 0.5 grammes for Variants 06 to 10 and 0.3 grammes for Variants 11 to 15.

4.3.3 Terminal Strength

The requirements for terminal strength testing are specified in Section 9 of ESA/SCC Generic Specification No. 5000. For Variants 01 to 10, the test conditions shall be as follows:-

Test Condition : 'A' (Tension).
Applied Force : 10 Newtons.
Duration : 10 seconds.

4.4 MATERIALS AND FINISHES

The materials and finishes shall be as specified herein. Where a definite material is not specified, a material which will enable the diodes specified herein to meet the performance requirements of this specification shall be used. Acceptance or approval of any constituent material does not guarantee acceptance of the finished product.

4.4.1 Case

The case shall be hermetically sealed and have a sintered glass body.

4.4.2 Lead Material and Finish

For Variants 01 to 10, the lead material shall be either Type 'A' or Type 'K' with Type '3 or 4' finish in accordance with the requirements of ESA/SCC Basic Specification No. 23500. (See Table 1(a) for Type Variants).

For Variants 11 to 15, the termination material shall be Type 'O' with Type '4' finish in accordance with the requirements of ESA/SCC Basic Specification No. 23500. (See Table 1(a) for Type Variants).



4.5 MARKING

4.5.1 General

The marking of all components delivered to this specification shall be in accordance with the requirements of ESA/SCC Basic Specification No. 21700 and the following paragraphs. When the component is too small to accommodate all of the marking specified, as much as space permits shall be marked and the marking information, in full, shall accompany the component in its primary package.

The information to be marked and the order of precedence, shall be as follows:-

- (a) Polarity.
- (b) The SCC Component Number.
- (c) Traceability Information.

4.5.2 Polarity

Polarity shall be as shown in Figure 3.

4.5.3 The SCC Component Number

Each component shall bear the SCC Component Number which shall be constituted and marked as follows:

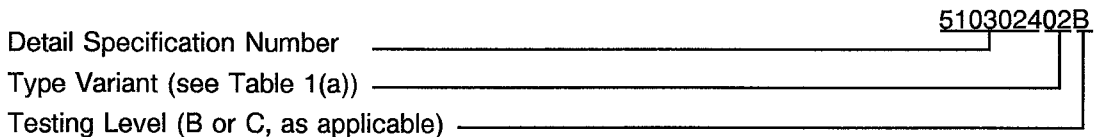

4.5.4 Traceability Information

Each component shall be marked in respect of traceability information in accordance with the requirements of ESA/SCC Basic Specification No. 21700.

4.6 ELECTRICAL MEASUREMENTS

4.6.1 Electrical Measurements at Room Temperature

The parameters to be measured at room temperature are scheduled in Table 2. Unless otherwise specified, the measurements shall be performed at $T_{amb} = +22 \pm 3$ °C.

4.6.2 Electrical Measurements at High and Low Temperatures

The parameters to be measured at high and low temperatures are scheduled in Table 3.

4.6.3 Circuits for Electrical Measurements

Circuits for use in performing the electrical measurements listed in Tables 2 and 3 are shown in Figure 4 of this specification.

4.7 BURN-IN TESTS

4.7.1 Parameter Drift Values

The parameter drift values applicable to burn-in are specified in Table 4 of this specification. Unless otherwise stated, the measurements shall be performed at $T_{amb} = +22 \pm 3$ °C. The parameter drift values (Δ) applicable to the parameters scheduled, shall not be exceeded. In addition to these drift value requirements, the appropriate limit value specified for a given parameter in Table 2 shall not be exceeded.



4.7.2 Conditions for High Temperature Reverse Bias Burn-in

The requirements for high temperature reverse bias burn-in are specified in Section 7 of ESA/SCC Generic Specification No. 5000. The conditions for high temperature reverse bias burn-in shall be as specified in Table 5(a) of this specification.

4.7.3 Conditions for Power Burn-in

The requirements for power burn-in are specified in Section 7 of ESA/SCC Generic Specification No. 5000. The conditions for power burn-in shall be as shown in Table 5(b) of this specification.

4.7.4 Electrical Circuits for High Temperature Reverse Bias Burn-in (Figure 5(a))

Not applicable.

4.7.5 Electrical Circuits for Power Burn-in (Figure 5(b))

Not applicable.

TABLE 2 - ELECTRICAL MEASUREMENTS AT ROOM TEMPERATURE - D.C. PARAMETERS

No.	CHARACTERISTICS	SYMBOL	TEST METHOD MIL-STD-750	TEST CONDITION	LIMITS		UNIT
					MIN.	MAX.	
1	Forward Voltage	V_F	4011	$I_F = 3.0A$ (Note 1)	0.8	1.3	Vdc
2	Reverse Current	I_R	4016	D.C. Method $V_R = V_{RWM} = \text{Note 2}$	-	0.5	μA
3	Breakdown Voltage	$V_{(BR)}$	4021	$I_R = -50\mu A$	(3)	-	Vdc

NOTES

1. Pulsed Measurement: Pulse length $\leq 300\mu s$; Duty Cycle $\leq 2\%$.
2. See Column 6 of Table 1(a).
3. See Column 5 of Table 1(a).

TABLE 2 - ELECTRICAL MEASUREMENTS AT ROOM TEMPERATURE - A.C. PARAMETERS

No.	CHARACTERISTICS	SYMBOL	TEST METHOD MIL-STD-750	TEST CONDITION	LIMITS		UNIT
					MIN.	MAX.	
4	Reverse Recovery Time	t_{rr}	4031 Cond. 'B'	$I_F = 0.5A$ $I_R = 1.0A$ $I_{RR} = 0.25A$ See Figure 4(a) (Note 1)	-	2.0	μs
5	Capacitance	C	4001	$V_R = 12.0V$ $0.1MHz \leq f < 1.0MHz$ (Note 1)	-	50	pF
6	Thermal Impedance	$Z_{TH(J-C)}$	3101	$I_H = 10A$ $t_H = 10ms$ $I_M = 10mA$ $t_{md} = 100\mu s$ maximum (Note 2)	-	4.5	$^{\circ}C/W$

NOTES

1. Measurements shall be performed on a sample basis, LTPD = 7 or lower.
2. During Chart II only.



TABLE 3 - ELECTRICAL MEASUREMENTS AT HIGH AND LOW TEMPERATURES

No.	CHARACTERISTICS	SYMBOL	TEST METHOD MIL-STD-750	TEST CONDITIONS	LIMITS		UNIT
					MIN.	MAX.	
2	Reverse Current	I_R	4016	D.C. Method $V_R = V_{RWM} = \text{Note 1}$ $T_{amb} = +100(+0-5) \text{ }^\circ\text{C}$ (Note 2)	-	25	μA

NOTES

1. See Column 6 of Table 1(a).
2. Measurements at low temperature are not applicable.

FIGURE 4 - CIRCUITS FOR ELECTRICAL MEASUREMENTS

FIGURE 4(a) - REVERSE RECOVERY TIME

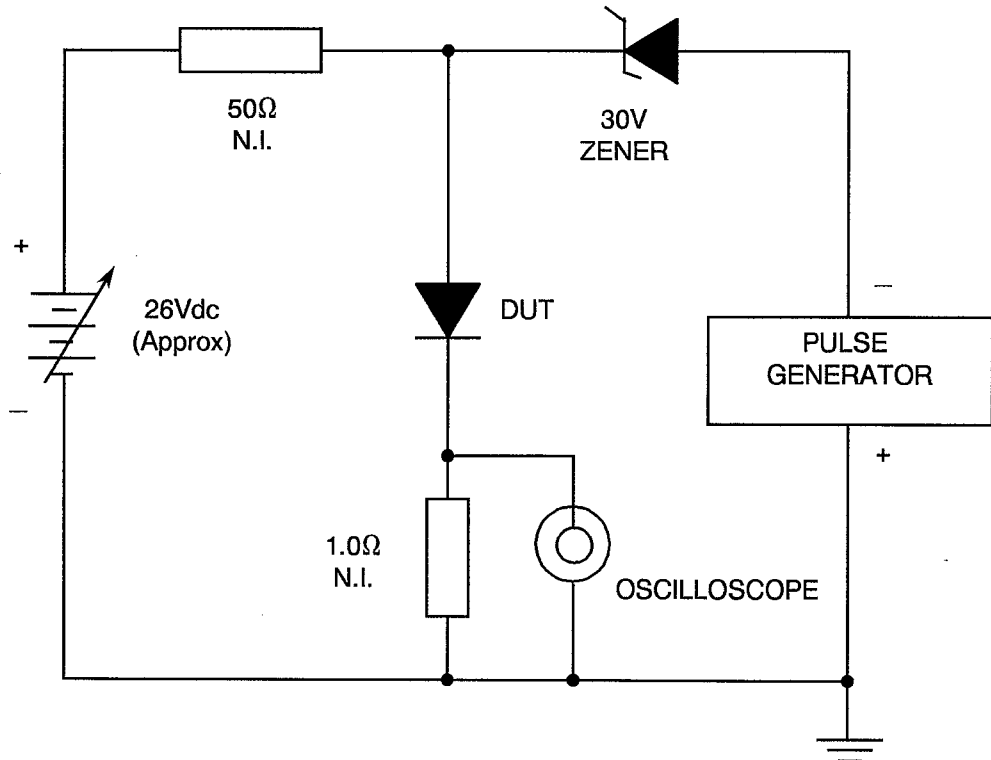

NOTES

1. Oscilloscope : $t_r \leq 7.0\text{ns}$; $Z_{IN} = 1.0\text{M}\Omega$, 22pF .
2. Pulse Generator : $t_r \leq 10\text{ns}$; $Z_S = 50\Omega$.

TABLE 4 - PARAMETER DRIFT VALUES

No.	CHARACTERISTICS	SYMBOL	SPEC. AND/OR TEST METHOD	TEST CONDITION	CHANGE LIMITS (Δ)	UNIT
1	Forward Voltage	V_F	As per Table 2	As per Table 2	± 100	mV
2	Reverse Current	I_R	As per Table 2	As per Table 2	± 100 or (1) ± 100	nA %

NOTES

1. Whichever is greater, referred to the initial value.

TABLE 5(a) - CONDITIONS FOR HIGH TEMPERATURE REVERSE BIAS BURN-IN

No.	CHARACTERISTICS	SYMBOL	CONDITION	UNIT
1	Ambient Temperature	T_{amb}	+ 150(+ 0 - 5)	$^{\circ}C$
2	Reverse Voltage	V_R	Variants 01, 06, 11 : 160 Variants 02, 07, 12 : 320 Variants 03, 08, 13 : 480 Variants 04, 09, 14 : 640 Variants 05, 10, 15 : 800	V
3	Duration	t	72	Hours

TABLE 5(b) - CONDITIONS FOR POWER BURN-IN AND OPERATING LIFE TESTS

No.	CHARACTERISTICS	SYMBOL	CONDITION	UNIT
1	Ambient Temperature	T_{amb}	MIL-STD-750	$^{\circ}C$
2	Working Peak Reverse Voltage	V_{RWM}	Note 1	V
3	Average Output Rectified Current	I_O	1.0 f = 50 to 60 Hz	A

NOTES

1. See Column 6 of Table 1(a).

FIGURE 5(a) - ELECTRICAL CIRCUIT FOR HIGH TEMPERATURE REVERSE BIAS BURN-IN

Not applicable.

FIGURE 5(b) - ELECTRICAL CIRCUIT FOR POWER BURN-IN AND OPERATING LIFE TESTS

Not applicable.

**4.8 ENVIRONMENTAL AND ENDURANCE TESTS (CHARTS IV AND V OF ESA/SCC GENERIC SPECIFICATION NO. 5000)****4.8.1 Electrical Measurements on Completion of Environmental Tests**

The parameters to be measured on completion of environmental tests are scheduled in Table 2. Unless otherwise stated, the measurements shall be performed at $T_{amb} = +22 \pm 3$ °C.

4.8.2 Electrical Measurements at Intermediate Points and on Completion of Endurance Tests

The parameters to be measured at intermediate points and on completion of endurance testing are scheduled in Table 6. Unless otherwise stated, the measurements shall be performed at $T_{amb} = +22 \pm 3$ °C.

4.8.3 Conditions for Operating Life Tests (Part of Endurance Testing)

The requirements for operating life testing are specified in Section 9 of ESA/SCC Generic Specification No. 5000. The conditions for operating life testing shall be as specified in Table 5(b) for the burn-in test.

4.8.4 Electrical Circuits for Operating Life Tests (Figure 5(b))

Not applicable.

4.8.5 Conditions for High Temperature Storage Test (Part of Endurance Testing)



The requirements for the high temperature storage test are specified in ESA/SCC Generic Specification No. 5000. The conditions for high temperature storage shall be the maximum storage temperature specified in Table 1(b) of this specification.

TABLE 6 - ELECTRICAL MEASUREMENTS AT INTERMEDIATE POINTS AND ON COMPLETION OF ENDURANCE TESTING

No.	CHARACTERISTICS	SYMBOL	SPEC. AND/OR TEST METHOD	TEST CONDITIONS	CHANGE LIMITS (Δ)	LIMITS		UNIT
						MIN.	MAX.	
1	D.C. Forward Voltage	V_F	As per Table 2	As per Table 2	$\pm 0.1V$	0.8	1.3	V
2	D.C. Reverse Current	I_R	As per Table 2	As per Table 2	$\pm 100nA$ or (1) $\pm 100\%$	-	0.5	μA

NOTES

1. Whichever is greater, referred to the initial value.

		ESA/SCC Detail Specification No. 5103/024		PAGE 19 ISSUE 2
---	---	--	--	--------------------

APPENDIX 'A'

Page 1 of 1

AGREED DEVIATIONS FOR MICROSEMI (IRL)

ITEMS AFFECTED	DESCRIPTION OF DEVIATIONS
Para. 4.2.2	Para. 9.5.1, Thermal Shock may be performed in accordance with MIL-STD-750, Test Method 1051, Test Condition 'C'. The maximum load temperature shall be + 175°C. Para. 9.8.2, Seal Test Gross Leak may be performed using Test Condition 'E'.