



europaean space agency  
agence spatiale européenne

Pages 1 to 18

**CAPACITORS, VARIABLE, CONCENTRIC**

**TRIMMER, AIR DIELECTRIC, 1 TO 10 pF,**

**BODY DIAMETER 6.2mm**

**ESA/SCC Detail Specification No. 3010/011**



**space components  
coordination group**

Issue/Rev.	Date	Approved by	
		SCCG Chairman	ESA Director General or his Deputy
Issue 3	August 1995		
Revision 'A'	June 1996		
Revision 'B'	February 2002		



**DOCUMENTATION CHANGE NOTICE**

Rev. Letter	Rev. Date	Reference	CHANGE Item	Approved DCR No.
		<p>This Issue supersedes Issue 2 and incorporates all changes agreed in the following DCR's:-</p> <p>Cover page DCN Table 1(b) : Notes rearranged Figure 2 : Clarity of Drawings improved Para. 3 : Test Voltage added Para. 4.2.3 : Title amended and deviations ref. Para. 9.3.3 deleted and incorporated as Note to Table 2 Para. 4.2.4 : Deviations ref. Para. 9.12 deleted and incorporated within Table 6 Para. 4.3.3 : Test conditions deleted Para. 4.3.5 : Deleted in toto Para. 4.7 : Title amended Para. 4.7.3 : New entry added Table 2 : Notes moved Table 3 : Test Numbers and Temperature Coefficient amended and related Notes revised Table 4 : Columns and Symbol changed Figure 5 : New entry added Para. 4.8 : Title amended Para. 4.8.1 to 4.8.3 : First sentence revised Para. 4.8.4 : At end of last sentence, reference to "Burn-in test" added Para. 4.8.5 : New entry added Table 6 : Reformatted</p>		<p>None None 23748 23748 23748 23748 23748 221282 221282 23748 23748 23748 23748 221282/ 23748 23748 23748 23748 23748 23748 23748 23748 23748 23748 23748 23748 23748</p>
'A'	June '96	P1. Cover Page P2. DCN P4. T of C P18. Appendix 'A'	: Page count amended  : "None" deleted and Appendix 'A' entry added : New page added	221305 None 221305 221305
'B'	Feb. '02	P1. Cover Page P2. DCN P18. Annex 'A'	: : : New sentence added	None None 221660

**TABLE OF CONTENTS**

	<u>Page</u>
<b>1. <u>GENERAL</u></b>	<b>5</b>
1.1 Scope	5
1.2 Type Variants	5
1.3 Maximum Ratings	5
1.4 Parameter Derating Information	5
1.5 Physical Dimensions	5
1.6 Functional Diagram	5
<b>2. <u>APPLICABLE DOCUMENTS</u></b>	<b>5</b>
<b>3. <u>TERMS, DEFINITIONS, ABBREVIATIONS, SYMBOLS AND UNITS</u></b>	<b>5</b>
<b>4. <u>REQUIREMENTS</u></b>	<b>10</b>
4.1 General	10
4.2 Deviations from Generic Specification	10
4.2.1 Deviations from Special In-process Controls	10
4.2.2 Deviations from Final Production Tests	10
4.2.3 Deviations from Burn-in and Electrical Measurements	10
4.2.4 Deviations from Qualification Tests	10
4.2.5 Deviations from Lot Acceptance Tests	10
4.3 Mechanical Requirements	10
4.3.1 Dimension Check	10
4.3.2 Weight	10
4.3.3 Robustness of Terminations	11
4.3.4 Resistance to Soldering Heat	11
4.4 Materials and Finishes	11
4.4.1 Body	11
4.4.2 Terminals	11
4.5 Marking	11
4.5.1 General	11
4.5.2 The SCC Component Number	11
4.5.3 Traceability Information	12
4.6 Electrical Measurements	12
4.6.1 Electrical Measurements at Room Temperature	12
4.6.2 Electrical Measurements at High and Low Temperatures	12
4.6.3 Circuits for Electrical Measurements	12
4.7 Burn-in Tests	12
4.8 Environmental and Endurance Tests	15
4.8.1 Measurements and Inspections on Completion of Environmental Tests	15
4.8.2 Measurements and Inspections at Intermediate Points during Endurance Tests	15
4.8.3 Measurements and Inspections on Completion of Endurance Tests	15
4.8.4 Conditions for Operating Life Tests	15
4.8.5 Electrical Circuit for Operating Life Tests	15

**ESC**ESA/SCC Detail Specification  
No. 3010/011

Rev. 'A'

PAGE 4

ISSUE 3

**TABLES**Page

1(a)	Type Variants	6
1(b)	Maximum Ratings	6
2	Electrical Measurements at Room Temperature	13
3	Electrical Measurements at High and Low Temperatures	13
4	Parameter Drift Values	14
5	Conditions for Operating Life Tests	14
6	Measurements and Inspections on Completion of Environmental Tests and at Intermediate Points and on Completion of Endurance Testing	16

**FIGURES**

1	Parameter Derating Information	N/A
2	Physical Dimensions	7
3	Functional Diagram	9
4	Circuits for Electrical Measurements	14
5	Electrical Circuit for Operating Life Tests	14

**APPENDICES (Applicable to specific Manufacturers only)**

'A'	Agreed Deviations for Tekelec (F)	18
-----	-----------------------------------	----

**1. GENERAL****1.1 SCOPE**

This specification details the ratings, physical and electrical characteristics, test and inspection data for Capacitors, Variable, Concentric Trimmer, Air Dielectric, 1 to 10 pF. It shall be read in conjunction with ESA/SCC Generic Specification No. 3010, the requirements of which are supplemented herein.

**1.2 TYPE VARIANTS**

The type variants covered by this specification are scheduled in Table 1(a).

**1.3 MAXIMUM RATINGS**

The maximum ratings, which shall not be exceeded at any time during use or storage, applicable to the capacitors specified herein are scheduled in Table 1(b).

**1.4 PARAMETER DERATING INFORMATION (FIGURE 1)**

Not applicable.

**1.5 PHYSICAL DIMENSIONS**

The physical dimensions of the capacitors specified herein are shown in Figure 2.

**1.6 FUNCTIONAL DIAGRAM**

The functional diagram for the capacitors specified herein is shown in Figure 3.

**2. APPLICABLE DOCUMENTS**

The following documents form part of this specification and shall be read in conjunction with it:-

- (a) ESA/SCC Generic Specification No. 3010 for Capacitors, Variable, Concentric Trimmer.
- (b) IEC Publication No. 68-2-21, Robustness of Terminations.

**3. TERMS, DEFINITIONS, ABBREVIATIONS, SYMBOLS AND UNITS**

For the purpose of this specification, the terms, definitions, abbreviations, symbols and units specified in ESA/SCC Basic Specification No. 21300 shall apply. In addition the following symbols are used:-

$T_{q0}$  = Operating Torque.

$V_T$  = Test Voltage.

**TABLE 1(a) - TYPE VARIANTS**

Variant	Capacitance (pF)		Temperature Coefficient (10 <sup>-6</sup> /°C)	Figure
	Min.	Max.		
01	1.0	10	± 50	2(a)
02	1.0	10	± 50	2(b)
03	1.0	10	± 50	2(c)
04	1.2	10	± 50	2(d)
05	1.0	10	± 50	2(e)

**TABLE 1(b) - MAXIMUM RATINGS**

No.	Characteristics	Symbol	Limits		Unit	Remarks
			Min.	Max.		
1	Rated Voltage	U <sub>R</sub>	-	250	V	-
2	Operating Temperature Range	T <sub>op</sub>	- 55	+ 125	°C	Without derating
3	Storage Temperature Range	T <sub>stg</sub>	- 55	+ 125	°C	-
4	Soldering Temperature	T <sub>sol</sub>	-	+ 260	°C	Note 1
5	Panel Mounting Nut Tightening Torque	-	-	20	cm.N	Note 2
6	Sealing Cap Tightening Torque	-	-	6.0	cm.N	Note 2

**NOTES**

- Duration 5.0 seconds maximum.
- Handling precautions:
  - Use appropriate turning tool.
  - Rotor shall not be disconnected from stator.
  - When cleaning with solvent, it is absolutely necessary to screw on a sealing cap.
  - Sealing cap shall not be used on flight units.
  - Sealing cap shall be supplied with all units.

**FIGURE 1 - PARAMETER DERATING INFORMATION**

Not applicable.



**FIGURE 2 - PHYSICAL DIMENSIONS**

**FIGURE 2(a) - VARIANT 01, LUG PANEL MOUNT**

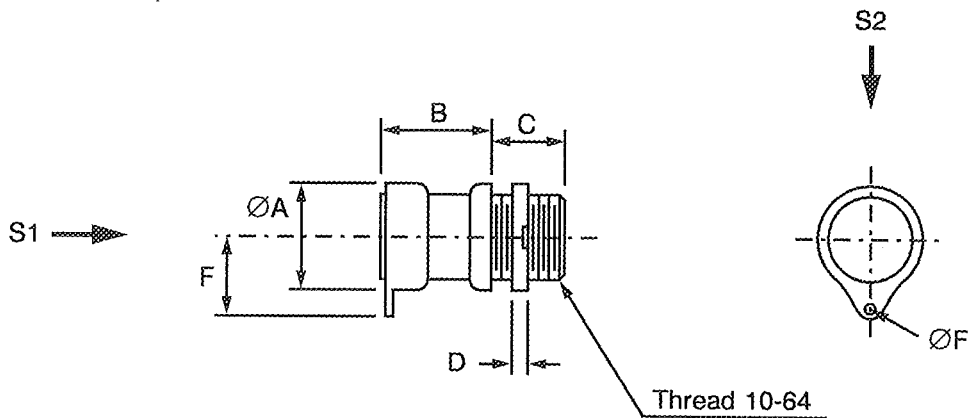

S1, S2 - Vibration and shock axis

		ØA	B	C	D	E	ØF
mm	MIN.	-	6.80	5.36	1.40	-	1.10
	MAX.	6.20	7.20	5.46	1.60	5.70	1.30

**FIGURE 2(b) - VARIANT 02, TURRET PANEL MOUNT**

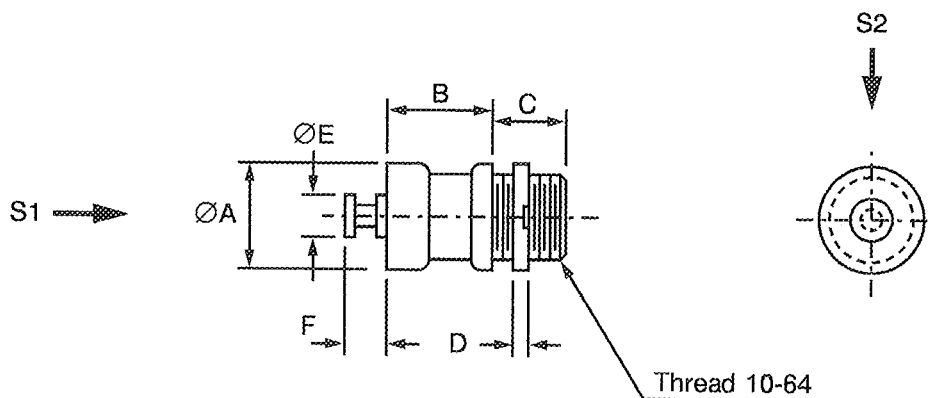

S1, S2 - Vibration and shock axis

		ØA	B	C	D	ØE	F
mm	MIN.	-	6.70	5.36	1.40	2.30	1.80
	MAX.	6.20	7.10	5.46	1.60	2.50	2.20



**FIGURE 2 - PHYSICAL DIMENSIONS (CONTINUED)**

**FIGURE 2(c) - VARIANT 03, P.C.B. MOUNT**

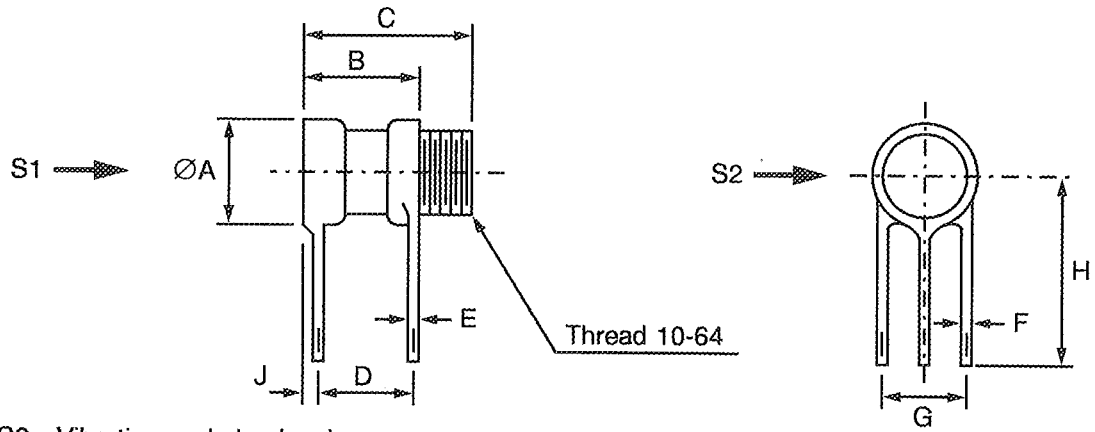

S1, S2 - Vibration and shock axis

		ØA	B	C	D	E	F	G	H	J
mm	MIN.	-	7.10	12.20	6.50	0.35	0.75	3.95	6.30	-
	MAX.	6.20	7.50	12.60	6.90	0.45	0.85	4.05	-	0.50

**FIGURE 2(d) - VARIANT 04, VERTICAL MOUNT**

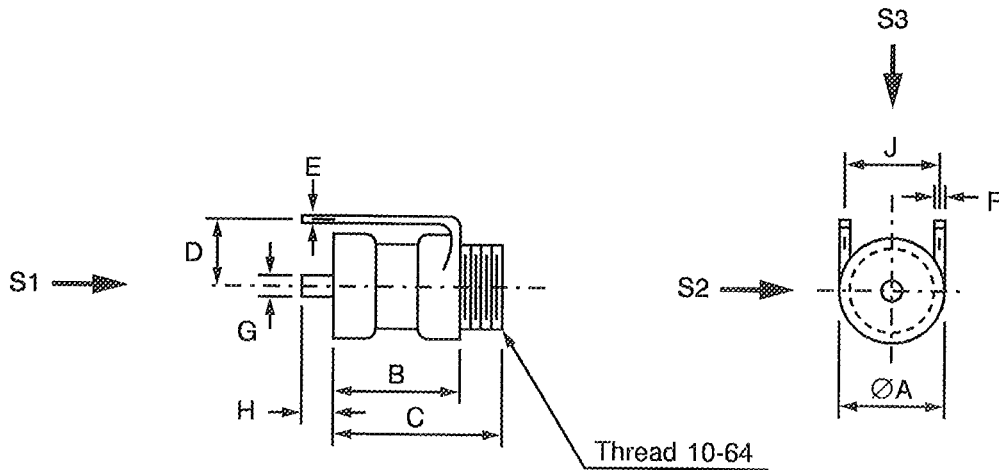

S1, S2, S3 - Vibration and shock axis

		ØA	B	C	D	E	F	G	H	J
mm	MIN.	-	7.10	12.20	3.80	0.35	0.75	1.05	-	3.95
	MAX.	6.20	7.50	12.60	4.20	0.45	0.85	1.15	3.00	4.05





**FIGURE 2 - PHYSICAL DIMENSIONS (CONTINUED)**

**FIGURE 2(e) - VARIANT 05, STRIP LINE MOUNT**

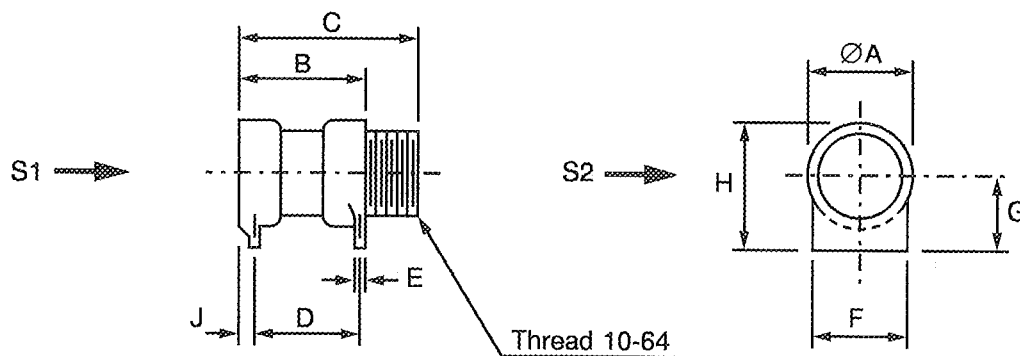

S1, S2 - Vibration and shock axis

		$\varnothing A$	B	C	D	E	F	G	H	J
mm	MIN.	-	7.10	12.20	6.50	0.35	5.55	3.15	-	-
	MAX.	6.20	7.50	12.60	6.90	0.45	5.60	3.25	6.40	0.50

**FIGURE 3 - FUNCTIONAL DIAGRAM**

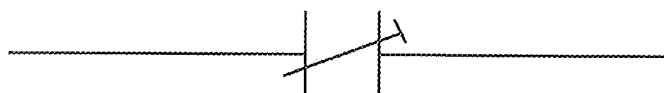



#### 4. REQUIREMENTS

##### 4.1 GENERAL

The complete requirements for procurement of the capacitors specified herein are stated in this specification and ESA/SCC Generic Specification No. 3010 for Capacitors, Variable, Concentric Trimmer. Deviations from the Generic Specification, applicable to this specification only, are listed in Para. 4.2.

Deviations from the applicable Generic Specification and this Detail Specification, formally agreed with specific Manufacturers on the basis that the alternative requirements are equivalent to the ESA/SCC requirements and do not affect the components' reliability, are listed in the appendices attached to this specification.

##### 4.2 DEVIATIONS FROM GENERIC SPECIFICATION

###### 4.2.1 Deviations from Special In-process Controls

None.

###### 4.2.2 Deviations from Final Production Tests (Chart II)

(a) Serialisation: Not applicable.

###### 4.2.3 Deviations from Burn-in and Electrical Measurements (Chart III)

(a) Para. 7.1, "Burn-in": Not applicable.

(b) Para. 9.3.2, "Parameter Drift Value Measurements": Not applicable.

###### 4.2.4 Deviations from Qualification Tests (Chart IV)

(a) Para. 9.15, "Mechanical Endurance": The 50 cycles shall be divided into 10 groups of 5 cycles. Upon completion of each group of 5 cycles, 1 minute of standing by shall be observed.

###### 4.2.5 Deviations from Lot Acceptance Tests (Chart V)

(a) Para. 9.15, "Mechanical Endurance": The 50 cycles shall be divided into 10 groups of 5 cycles. Upon completion of each group of 5 cycles, 1 minute of standing by shall be observed.

##### 4.3 MECHANICAL REQUIREMENTS

###### 4.3.1 Dimension Check

The dimensions of the capacitors specified herein shall be verified in accordance with the requirements set out in Para. 9.5 of ESA/SCC Generic Specification No. 3010 and they shall conform to those shown in Figure 2 of this specification.

###### 4.3.2 Weight

The maximum weight of the capacitors specified herein shall be 2.0 grammes.



4.3.3 Robustness of Terminations

The requirements for robustness of terminations are specified in Section 9 of ESA/SCC Generic Specification No. 3010.

Applicable to Variants 03 and 04 only.

4.3.4 Resistance to Soldering Heat

The requirements for resistance to soldering heat are specified in Section 9 of ESA/SCC Generic Specification No. 3010. The test conditions shall be as follows:-

Immersion Depth: To within 1.0mm from the body.

Immersion Time: 3.5 ± 0.5 seconds.

4.4 MATERIALS AND FINISHES

The materials and finishes shall be as specified herein. Where a definite material is not specified, a material which will enable the capacitors specified herein to meet the performance requirements of this specification shall be used. Acceptance or approval of any constituent material does not guarantee acceptance of the finished product.

4.4.1 Body

Ceramic.

4.4.2 Terminals

Terminals shall be gold-plated or tinned.

4.5 MARKING

4.5.1 General

The marking of components delivered to this specification shall be in accordance with the requirements of ESA/SCC Basic Specification No. 21700 and the following paragraphs. When the component is too small to accommodate all of the marking specified, as much as space permits shall be marked and the marking information, in full, shall accompany the component in its primary package.

The information to be marked and the order of precedence, shall be as follows:-

(a) The SCC Component Number.

(b) Traceability Information.

4.5.2 The SCC Component Number

The SCC Component Number shall be constituted and marked as follows:-

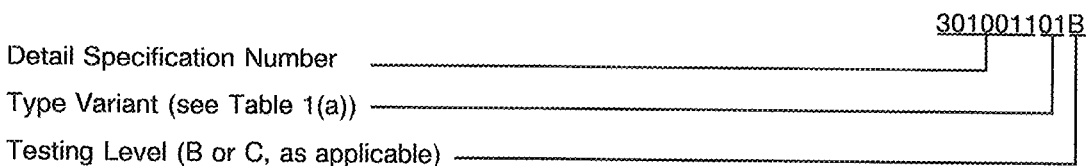



#### 4.5.3 Traceability Information

Traceability information shall be marked in accordance with the requirements of ESA/SCC Basic Specification No. 21700.

- (a) Manufacturing Date Code.
- (b) Serial Number.
- (c) Manufacturer's Name.

#### 4.6 ELECTRICAL MEASUREMENTS

##### 4.6.1 Electrical Measurements at Room Temperature

The parameters to be measured at room temperature are scheduled in Table 2. Unless otherwise specified, measurements shall be performed at  $T_{amb} = +22 \pm 3$  °C.

##### 4.6.2 Electrical Measurements at High and Low Temperatures

The parameters to be measured at high and low temperatures are scheduled in Table 3.

##### 4.6.3 Circuits for Electrical Measurements

Not applicable.

#### 4.7 BURN-IN TESTS

Not applicable.

**TABLE 2 - ELECTRICAL MEASUREMENTS AT ROOM TEMPERATURE**

No.	Characteristics	Symbol	ESA/SCC 3010 Test Method	Test Conditions	Limits		Unit
					Min	Max	
1	Minimum Capacitance	C <sub>m</sub>	Para. 9.3.1.1	1.0 ± 0.1MHz	-	1.0 (1)	pF
2	Maximum Capacitance	C <sub>M</sub>	Para. 9.3.1.1	1.0 ± 0.1MHz	10	-	pF
3	Change in Capacitance	-	Para. 9.3.1.2	1.0 ± 0.1MHz Note 2	-	-	-
4	Insulation Resistance	R <sub>i</sub>	Para. 9.3.1.3	500V ± 25V	10 <sup>6</sup>	-	MΩ
5	Voltage Proof	VP	Para. 9.3.1.4	-	500	-	V
6	Quality Factor	Q	Para. 9.3.1.5	100 ± 5.0MHz Note 3	7500	-	-
7	Operating Torque	T <sub>q0</sub>	Para. 9.3.1.6	C minimum to maximum	0.3	2.8	N.cm

**NOTES**

1. Except 1.2pF for Variant 04.
2. No change of sign over the entire adjustment range.
3. Sampling Level II, AQL = 1.0%.

**TABLE 3 - ELECTRICAL MEASUREMENTS AT HIGH AND LOW TEMPERATURES**

No.	Characteristics	Symbol	ESA/SCC 3010 Test Method	Test Conditions (Note 1)	Limits		Unit
					Min	Max	
4	Insulation Resistance at T <sub>amb</sub> = +125 ± 3 °C	R <sub>i</sub>	Para. 9.3.1.3	500V ± 25V	10 <sup>5</sup>	-	MΩ
8(i)	Temperature Coefficient	TC1	Para. 9.18	Between -55 and +22 °C Note 2	-50	+50	10 <sup>-6</sup> /°C
8(ii)	Temperature Coefficient	TC2	Para. 9.18	Between +22 and +125 °C Note 2	-50	+50	10 <sup>-6</sup> /°C

**NOTES**

1. Inspection Level II, AQL 2.5%.
2. Trimmers set at approx. 75% of rated max. capacitance.

**FIGURE 4 - CIRCUITS FOR ELECTRICAL MEASUREMENTS**

Not applicable.

**TABLE 4 - PARAMETER DRIFT VALUES**

Not applicable.

**TABLE 5 - CONDITIONS FOR OPERATING LIFE TESTS**

No.	Characteristic	Symbol	Condition	Unit
1	Ambient Temperature	$T_{amb}$	+ 125(+ 0 - 3)	°C
2	Test Voltage	$V_T$	375	V

**FIGURE 5 - ELECTRICAL CIRCUIT FOR OPERATING LIFE TESTS**

Not applicable.



- 4.8 ENVIRONMENTAL AND ENDURANCE TESTS (CHARTS IV AND V OF ESA/SCC GENERIC SPECIFICATION No. 3010)
- 4.8.1 Measurements and Inspections on Completion of Environmental Tests  
The parameters to be measured and inspections to be performed on completion of environmental tests are scheduled in Table 6. Unless otherwise specified, the measurements shall be performed at  $T_{amb} = +22 \pm 3$  °C.
- 4.8.2 Measurements and Inspections at Intermediate Points during Endurance Tests  
The parameters to be measured and inspections to be performed at intermediate points during endurance tests are scheduled in Table 6. Unless otherwise specified, the measurements shall be performed at  $T_{amb} = +22 \pm 3$  °C.
- 4.8.3 Measurements and Inspections on Completion of Endurance Tests  
The parameters to be measured and inspections to be performed on completion of endurance testing are scheduled in Table 6. Unless otherwise specified, the measurements shall be performed at  $T_{amb} = +22 \pm 3$  °C.
- 4.8.4 Conditions for Operating Life Tests (Part of Endurance Testing)  
The requirements for operating life testing are specified in Section 9 of ESA/SCC Generic Specification No. 3010. The conditions for operating life testing shall be as specified in Table 5 for the Burn-in test
- 4.8.5 Electrical Circuit for Operating Life Tests (Figure 5)  
Not applicable.



**TABLE 6 - MEASUREMENTS AND INSPECTIONS ON COMPLETION OF ENVIRONMENTAL TESTS AND AT INTERMEDIATE POINTS AND ON COMPLETION OF ENDURANCE TESTING**

NO.	ESA/SCC GENERIC SPEC. NO. 3010		MEASUREMENTS AND INSPECTIONS		SYMBOL	LIMITS		UNIT
	ENVIRONMENTAL AND ENDURANCE TESTS (1)	TEST METHOD AND CONDITIONS	IDENTIFICATION	CONDITIONS		MIN.	MAX.	
01	Rapid Change of Temperature	Para. 9.2	<b>Initial Measurements</b> Capacitance  <b>Final Measurements</b> Capacitance Drift	Table 2 Items 1 & 2  After a recovery period of 24 ± 3 hrs Table 2 Items 1 & 2	CM & Cm  ΔCM & ΔCm	Table 2  - 0.05    + 0.05 - 0.5     + 0.5		pF  pF or (4) %
02	Electrical and Mechanical Measurements	Para. 9.3.4	Electrical and Mechanical Measurements	Table 2		Table 2		
03	Robustness of Terminations	Para. 9.6 & Para. 4.3.3 of this spec.	None	-	-	-	-	-
04	Solderability	Para. 9.7	Visual Examination	Magn. 10X to 30X	-	-	-	-
05	Resistance to Soldering Heat	Para. 9.8 & Para. 4.3.4 of this spec.	<b>Initial Measurements</b> Capacitance  <b>Final Measurements</b> Capacitance Drift  Voltage Proof Quality Factor	Table 2 Item 1 at 0.75 CM After a recovery period of 24 ± 3 hrs Table 2 Item 1 at 0.75 CM Table 2 Item 5 Table 2 Item 6	C  ΔC Vp Q	-  - 0.05 500 7500	-  + 0.05 + 1.0 -	pF  pF or (4) % V -
06	Vibration	Para. 9.9	<b>Initial Measurements</b> Capacitance  <b>During Test</b> Visual Examination  <b>Final Measurements</b> Capacitance Drift	Table 2 Item 1 at 0.75 CM  No arcing or shorting > 0.5ms  Table 2 Item 1 at 0.75 CM	C  -  ΔC	-  -  - 0.05 - 1.0	-  -  + 0.05 + 1.0	pF  -  pF or (4) %
07	Shock or Bump	Para. 9.10	<b>Initial Measurements</b> Capacitance  <b>During Test</b> Visual Examination  <b>Final Measurements</b> Capacitance Drift	Table 2 Item 1 at 0.75 CM  No arcing or shorting > 0.5ms  Table 2 Item 1 at 0.75 CM	C  -  ΔC	-  -  - 0.05 - 1.0	-  -  + 0.05 + 1.0	pF  -  pF or (4) %
08	Climatic Sequence	Para. 9.11	<b>Initial Measurements</b> Capacitance  <b>During Test</b> Visual Examination  <b>Final Measurements</b> Visual Examination Capacitance Drift  Quality Factor Insulation Resistance Voltage Proof Operating Torque	Table 2 Item 1 at 0.75 CM Post Dry Heat & Cold Tests No evidence of mechanical damage After a recovery period of 24 ± 3 hrs No evidence of damage Table 2 Item 1 at 0.75 CM Table 2 Item 6 Table 2 Item 4 Table 2 Item 5 Table 2 Item 7	C  -  -  ΔC Q Ri Vp T <sub>qo</sub>	-  -  -  - 0.05 - 1.0 7500 10 <sup>5</sup> 500 0.3	-  -  -  + 0.05 + 1.0 - - - 2.8	pF  -  -  pF or (4) % - MΩ V N.cm

- NOTES**
1. The tests in this Table refer to either Chart IV or V and shall be used as applicable.
  2. No change of sign over the entire adjustment range.
  3. 1000 hrs Intermediate and 2000 hrs Final relate to Qualification Testing (Chart IV) only
  4. Whichever is greater.





**TABLE 6 - MEASUREMENTS AND INSPECTIONS ON COMPLETION OF ENVIRONMENTAL TESTS AND AT INTERMEDIATE POINTS AND ON COMPLETION OF ENDURANCE TESTING (CONT'D)**

NO.	ESA/SCC GENERIC SPEC. NO. 3010		MEASUREMENTS AND INSPECTIONS		SYMBOL	LIMITS		UNIT
	ENVIRONMENTAL AND ENDURANCE TESTS (1)	TEST METHOD AND CONDITIONS	IDENTIFICATION	CONDITIONS		MIN.	MAX.	
09	Damp Heat, Steady State	Para. 9.12 and Para. 4.3.5 of this specification Half of components with $U_R$ applied, half of components without $U_R$ applied.	<b>Initial Measurements</b> Capacitance  <b>Final Measurements</b> Capacitance Drift  Quality Factor Insulation Resistance Insulation Resistance Voltage Proof Operating Torque	Table 2 Items 1 & 2  After a recovery period of $24 \pm 2$ hrs Table 2 Items 1 & 2  Table 2 Item 6 Table 2 Item 4 Table 2 Item 4 Table 2 Item 5 Table 2 Item 7	CM & Cm  $\Delta$ CM & $\Delta$ Cm Q Ri CM Ri CM Vp T <sub>qo</sub>	Table 2  -0.05 -2.0 7500 10 <sup>5</sup> 10 <sup>5</sup> 500 0.3		+0.05 +2.0 - - - - 2.8  pF pF or (4) % - MΩ MΩ V N.cm
10	End Stop Torque	Para. 9.13 Torque: 4.0 N.cm Duration: $5.0 \pm 1$ s	<b>Final Measurements</b> Minimum Capacitance Maximum Capacitance External Visual Inspection	Table 2 Item 1 Table 2 Item 2 Para 9.4 of ESA/SCC 3010	Cm CM -	- Tab.1(a) -	Tab.1(a) - -	pF pF -
11	Axial Thrust	Para. 9.14 Thrust: 6.0 N max.	<b>Initial Measurements</b> Capacitance  <b>During Test</b> Capacitance Drift	Table 2 Item 1 at 0.75 CM With Thrust applied Table 2 Item 1 at 0.75 CM	C  $\Delta$ C	-  -0.05 -1.0	-  +0.05 +1.0	pF  pF or (4) %
12	Mechanical Endurance	Para. 9.15	<b>During Test</b> Voltage Proof Capacitance vs Rotation  Operating Torque Insulation Resistance  <b>Final Measurements</b> Voltage Proof Minimum Capacitance Maximum Capacitance Insulation Resistance Insulation Resistance Quality Factor	After initial 50 cycles Table 2 Item 5 Para. 9.15 of ESA/SCC 3010 Table 2 Item 7 Between rotor screw and base, Para. 9.15 of ESA/SCC 3010  Table 2 Item 5 Table 2 Item 1 Table 2 Item 2 Table 2 Item 4 Table 2 Item 4 Table 2 Item 6	Vp $\Delta$ C  T <sub>qo</sub> Ri  Vp Cm CM Ri CM Ri CM Q	500 Deviation $\pm 10\%$ max. (2) 0.15 3.8 Table 2 Item 4  500 - Tab.1(a) 10 <sup>6</sup> 10 <sup>6</sup> 7500	-  - 3.8 - Tab.1(a) - - -	V - N.cm MΩ  V pF pF MΩ MΩ -
13	Operating Life	Para. 9.16 Change limits relate to initial (0- hour) measurements	<b>Initial Measurements</b> Capacitance <b>Intermediate Measurements</b>  Capacitance Drift  Insulation Resistance Voltage Proof Quality Factor Operating Torque <b>Final Measurements</b>  Capacitance Drift  Insulation Resistance Voltage Proof Quality Factor Operating Torque	Table 2 Item 1 500 & 1000 hrs (3) After a recovery period of $4 \pm 2$ hrs Table 2 Item 1  Table 2 Item 4 Table 2 Item 5 Table 2 Item 6 Table 2 Item 7 1000 & 2000 hrs (3) After a recovery period of $24 \pm 2$ hrs Table 2 Item 1  Table 2 Item 4 Table 2 Item 5 Table 2 Item 6 Table 2 Item 7	CM  $\Delta$ CM  Ri CM Vp Q T <sub>qo</sub>  $\Delta$ CM  Ri CM Vp Q T <sub>qo</sub>	Table 2  -0.05 -2.0 +0.05 +2.0 pF or (4) % MΩ V - N.cm  -0.05 -2.0 +0.05 +2.0 pF or (4) % MΩ V - N.cm		
14	Temperature Coefficient	Para. 9.18	Temperature Coefficient	Table 3 Item 8(i) or 8(ii)	TC	Table 1(a)		$10^{-6}/^{\circ}\text{C}$

NOTES: See Page 16.



APPENDIX 'A'

Page 1 of 1

AGREED DEVIATIONS FOR TEKELEC (F)

Para. 9.3.1.5, Quality Factor of ESA/SCC Generic Specification No. 3010 and Table 2 of this specification.

Measurement of the Q factor shall be performed at frequencies comprised between 100 and 400 MHz.

The value of the Q factor shall be determined at 100MHz by using the following formula:

$$Q_{fo} = Q_m \times (f_m/f_o)^{3/2}$$

where  $Q_m$  is the Q factor read at frequency  $f_m$  ( $f_m$  is that frequency where the quarter-wave line, including the capacitance being measured, is resonating) and  $f_o = 100\text{MHz}$ .

The record sheet shall indicate the Q factor at 100MHz, as required by Table 2 of this specification, as well as the frequency  $f_m$  at which the Q factor was read.

For LAT level 3: The measurements of the Q factor required by Table 2 of this specification must be done before solderability.