



europaean space agency
agence spatiale européenne

Pages 1 to 16

CAPACITORS, FIXED, CHIP, HIGH VOLTAGE (1.0 To 3.0 kV)



CERAMIC DIELECTRIC, TYPE II

BASED ON TYPES 1812 AND 1825

ESA/SCC Detail Specification No. 3009/034

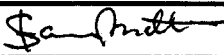
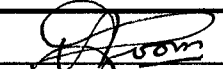

**space components
coordination group**

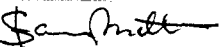
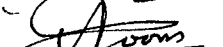
Issue/Rev.	Date	Approved by	
		SCCG Chairman	ESA Director General or his Deputy
Issue 1	September 1997		
Revision 'A'	January 1999		
Revision 'B'	April 1999		

**SCC**ESA/SCC Detail Specification
No. 3009/034

Rev. 'B'

PAGE 2

ISSUE 1

DOCUMENTATION CHANGE NOTICE

Rev. Letter	Rev. Date	Reference	CHANGE Item	Approved DCR No.
'A'	Jan. '99	P1. P2. P11.	Cover page DCN Table 2 d.c. : No. 4, Test Conditions corrected	None None 23898
'B'	Apr. '99	P1. P2. P16.	Cover page DCN Appendix 'A' : In the Para. 4.2.1 entry the document reference amended	None None 23906

**TABLE OF CONTENTS**

	<u>Page</u>
1. <u>GENERAL</u>	5
1.1 Scope	5
1.2 Component Type Variants	5
1.3 Maximum Ratings	5
1.4 Parameter Derating Information	5
1.5 Physical Dimensions	5
1.6 Functional Diagram	5
2. <u>APPLICABLE DOCUMENTS</u>	5
3. <u>TERMS, DEFINITIONS, ABBREVIATIONS, SYMBOLS AND UNITS</u>	5
4. <u>REQUIREMENTS</u>	8
4.1 General	8
4.2 Deviations from Generic Specification	8
4.2.1 Deviations from Special In-process Controls	8
4.2.2 Deviations from Final Production Tests	8
4.2.3 Deviations from Burn-in and Electrical Measurements	8
4.2.4 Deviations from Qualification Tests	8
4.2.5 Deviations from Lot Acceptance Tests	8
4.3 Mechanical Requirements	8
4.3.1 Dimension Check	8
4.3.2 Weight	8
4.3.3 Adhesion	8
4.4 Materials and Finishes	9
4.4.1 Terminations	9
4.5 Marking	9
4.5.1 General	9
4.5.2 The SCC Component Number	9
4.5.3 Electrical Characteristics	9
4.5.4 Traceability Information	10
4.6 Electrical Measurements	10
4.6.1 Electrical Measurements at Room Temperature	10
4.6.2 Electrical Measurements at High and Low Temperatures	10
4.6.3 Circuits for Electrical Measurements	10
4.7 Burn-in Tests	10
4.7.1 Parameter Drift Values	10
4.7.2 Conditions Burn-in	10
4.7.3 Electrical Circuit for Burn-in	10
4.8 Environmental and Endurance Tests	13
4.8.1 Measurements and Inspections on Completion of Environmental Tests	13
4.8.2 Measurements and Inspections at Intermediate Points during Endurance Tests	13
4.8.3 Measurements and Inspections on Completion of Endurance Tests	13
4.8.4 Conditions for Operating Life Test	13
4.8.5 Electrical Circuit for Operating Life Test	13



TABLES

	<u>Page</u>
1(a) Type Variants	6
1(b) Maximum Ratings	6
2 Electrical Measurements at Room Temperature	11
3 Electrical Measurements at High and Low Temperatures	11
4 Parameter Drift Values	12
5 Conditions for Burn-in and Operating Life Test	12
6 Electrical Measurements on Completion of Environmental Tests and at Intermediate Points, and on Completion of Endurance Tests.	14

FIGURES

1 Parameter Derating Information	N/A
2 Physical Dimensions	7
3 Functional Diagram	7
4 Circuits for Electrical Measurements	N/A
5 Electrical Circuits for Burn-in and Operating Life Test	N/A

APPENDICES (Applicable to specific Manufacturers only)

'A' Agreed Deviations for AVX Ltd., Coleraine (U.K.)	16
--	----

	<p style="text-align: center;">ESA/SCC Detail Specification No. 3009/034</p>	<p>PAGE 5 ISSUE 1</p>
---	--	---------------------------

1. GENERAL

1.1 SCOPE

This specification details the ratings, physical and electrical characteristics, test and inspection data for a Capacitors, Fixed, Chip, High Voltage (1.0 to 3.0 kV), Ceramic Dielectric, Type II, based on Types 1812 and 1825. It shall be read in conjunction with ESA/SCC Generic Specification No. 3009, the requirements of which are supplemented herein.

1.2 COMPONENT TYPE VARIANTS

Variants of the basic type capacitors specified herein, which are also covered by this specification, are given in Table 1(a).

1.3 MAXIMUM RATINGS

The maximum ratings, which shall not be exceeded at any time during use or storage, applicable to the capacitors specified herein are scheduled in Table 1(b).

1.4 PARAMETER DERATING INFORMATION

Not applicable.

1.5 PHYSICAL DIMENSIONS

The physical dimensions of the capacitors specified herein are shown in Figure 2.

1.6 FUNCTIONAL DIAGRAM

The functional diagram of the capacitors specified herein, is shown in Figure 3.

2. APPLICABLE DOCUMENTS

The following documents form part of this specification and shall be read in conjunction with it:-

- (a) ESA/SCC Generic Specification No. 3009 for Capacitors, Fixed, Chips, Ceramic Dielectric, Types I and II.

3. TERMS, DEFINITIONS, ABBREVIATIONS, SYMBOLS AND UNITS

For the purpose of this specification, the terms, definitions, abbreviations, symbols and units specified in ESA/SCC Basic Specification No. 21300 shall apply.

TABLE 1(a) - TYPE VARIANTS

VARIANT	BASED ON TYPE	RATED VOLTAGE (kV)	TOLERANCE (%)	CAPACITANCE RANGE (pF) (E12)	
01 and 13	1812	1.0	± 10	3 900 to 22 000	
02 and 14			± 20		
03 and 15		2.0	± 10		1 500 to 1 800
04 and 16			± 20		
05 and 17		3.0	± 10		820 to 1 000
06 and 18			± 20		
07 and 19	1825	1.0	± 10	27 000 to 56 000	
08 and 20			± 20		
09 and 21		2.0	± 10		2 200 to 6 800
10 and 22			± 20		
11 and 23		3.0	± 10		820 to 3 900
12 and 24			± 20		

TABLE 1(b) - MAXIMUM RATINGS

No.	CHARACTERISTICS	SYMBOL	MAXIMUM RATINGS		UNIT	REMARKS
			MIN.	MAX.		
1	Rated Voltage	U_R	See Table 1(a)		V	
2	Operating Temperature Range	T_{op}	- 55	+ 125	°C	
3	Storage Temperature Range	T_{stg}	- 55	+ 125	°C	
4	Soldering Temperature	T_{sol}	-	+ 260	°C	Note 1

NOTES

1. Soldering time 5 seconds maximum.

FIGURE 1 - PARAMETER DERATING INFORMATION

Not applicable.

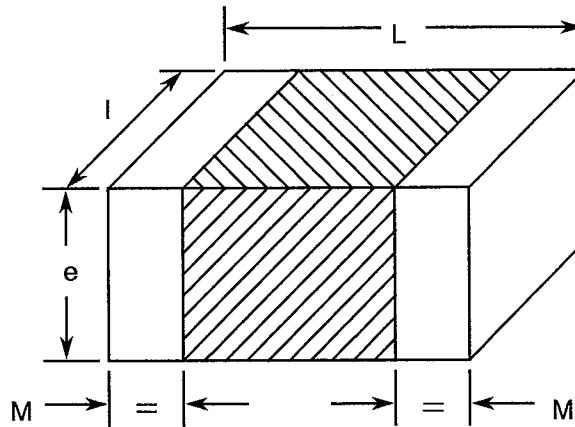

FIGURE 2 - PHYSICAL DIMENSIONS

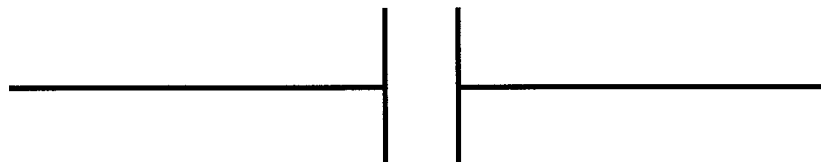

SYMBOL	DIMENSIONS (mm)							
	VARIANTS 01 to 06		VARIANTS 07 to 12		VARIANTS 13 to 18		VARIANTS 19 to 24	
	MIN.	MAX.	MIN.	MAX.	MIN.	MAX.	MIN.	MAX.
L	4.2	5.0	4.2	5.0	4.2	5.5	4.2	5.5
l	2.8	3.6	5.67	6.67	2.8	4.1	5.67	7.17
e	-	3.0	-	3.3	-	3.5	-	3.8
M	0.25	0.75	0.25	0.75	0.25	0.75	0.25	0.75

FIGURE 3 - FUNCTIONAL DIAGRAM



 	ESA/SCC Detail Specification No. 3009/034	PAGE 8 ISSUE 1
---	--	-------------------

4. REQUIREMENTS

4.1 GENERAL

The complete requirements for procurement of the capacitors specified herein are stated in this specification and ESA/SCC Generic Specification No. 3009. Capacitors, Fixed, Chips, Ceramic Dielectric, Types I and II. Deviations from the Generic Specification, applicable to this specification only, are listed in Para. 4.2.

Deviations from the applicable Generic Specification and this Detail Specification, formally agreed with specific Manufacturers on the basis that the alternative requirements are equivalent to the ESA/SCC requirements and do not affect the components' reliability, are listed in the appendices attached to this specification.

4.2 DEVIATIONS FROM GENERIC SPECIFICATION

4.2.1 Deviations from Special In-process Controls

None.

4.2.2 Deviations from Final Production Tests (Chart II)

Para. 9.2.2, Preconditioning: Shall not be performed.

4.2.3 Deviations from Burn-in and Electrical Measurements (Chart III)

None.

4.2.4 Deviations from Qualification Tests (Chart IV)

None.

4.2.5 Deviations from Lot Acceptance Tests (Chart V)

None.

4.3 MECHANICAL REQUIREMENTS

4.3.1 Dimension Check

The dimensions of the capacitors specified herein shall be verified in accordance with the requirements set out in Para. 9 of ESA/SCC Generic Specification No. 3009 and shall conform to those shown in Figure 2 of this specification.

4.3.2 Weight

The maximum weight of the capacitors specified herein shall be:

- Variants 01 to 06 and 13 to 18 (1812) - 0.3 grammes.
- Variants 07 to 12 and 19 to 24 (1825) - 0.6 grammes.

4.3.3 Adhesion

The requirements for adhesion are specified in Para. 9 of ESA/SCC Generic Specification No. 3009.

4.4 MATERIALS AND FINISHES

The materials and finishes shall be as specified herein. Where a definite material is not specified, a material which will enable the capacitors specified herein to meet the performance requirements of this specification shall be used. Acceptance or approval of any constituent material does not guarantee acceptance of the finished product.

4.4.1 Terminations

(a) Variants 01 to 12

The capacitors shall be terminated with metallised pads.

(b) Variants 13 to 24

The capacitors shall be terminated with solder coating, 188°C, 62% Sn, 36% Pb, 2% Ag.

4.5 MARKING

4.5.1 General

The marking of all components delivered to this specification shall be in accordance with the requirements of ESA/SCC Basic Specification No. 21700 and the following paragraphs. When the component is too small to accommodate all of the marking specified, as much as space permits shall be marked and the marking information, in full, shall accompany the component in its primary package.

The information to be marked and the order of precedence, shall be as follows:-

- (a) The SCC Component Number.
- (b) Electrical Characteristics.
- (c) Traceability Information.

4.5.2 The SCC Component Number

Each component shall bear the SCC Component Number which shall be constituted and marked as follows:-

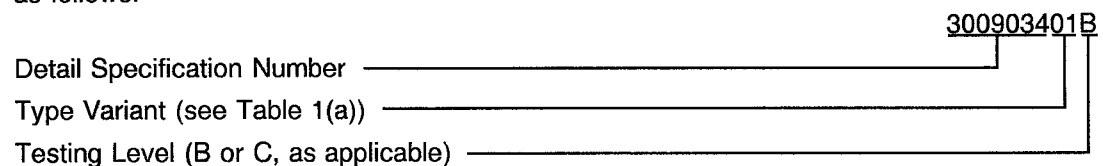

4.5.3 Electrical Characteristics

The electrical characteristics to be marked are:-

- (a) Capacitance Value.

The information shall be constituted and marked as follows:-

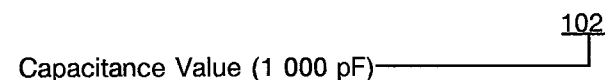

4.5.3.1 Capacitance Values

The capacitance values shall be expressed by means of the following codes. The unit quantity for marking shall be picofarads.

CAPACITANCE VALUE	CODE
XX10 ¹	XX1
XX10 ²	XX2
XX10 ³	XX3

4.5.4 Traceability Information

Each component shall be marked in respect of traceability information in accordance with the requirements of ESA/SCC Basic Specification No. 21700.

4.6 ELECTRICAL MEASUREMENTS

4.6.1 Electrical Measurements at Room Temperature

The parameters to be measured at room temperature are scheduled in Table 2. Unless otherwise specified, measurements shall be performed at $T_{amb} = +22 \pm 3$ °C.

4.6.2 Electrical Measurements at High and Low Temperatures

The parameters to be measured at high and low temperatures are scheduled in Table 3. The measurements shall be performed at $T_{amb} = -55$ °C and $+125$ °C

4.6.3 Circuits for Electrical Measurements (Figure 4).

Not applicable.

4.7 BURN-IN TESTS

4.7.1 Parameter Drift Values

The parameter drift values applicable to burn-in are specified in Table 4 of this specification. Unless otherwise stated, measurements shall be performed at $T_{amb} = +22 \pm 3$ °C. The parameter drift values (Δ) applicable to the parameters scheduled shall not be exceeded. In addition to these drift value requirements for a given parameter, the appropriate limit value specified in Table 2 shall not be exceeded.

4.7.2 Conditions for Burn-in

The requirements for burn-in are specified in Section 7 of ESA/SCC Generic Specification No. 3009. The conditions for burn-in are specified in Table 5 of this specification.

4.7.3 Electrical Circuit for Burn-in (Figure 5)

Not applicable.

TABLE 2 - ELECTRICAL MEASUREMENTS AT ROOM TEMPERATURE - a.c. PARAMETERS

No.	CHARACTERISTICS	SYMBOL	ESA/SCC 3009 TEST CONDITIONS	LIMITS		UNIT
				MIN.	MAX.	
1	Capacitance	C	Para. 9.4.1.1	-10 -20	+10 +20	%
2	Tangent of Loss Angle	$T_g\delta$	Para. 9.4.1.2	-	250	10^{-4}
3	Insulation Resistance	Ri Ri x C	Para. 9.4.1.3 C ≤ 10 000pF C > 10 000pF	100 1 000	- -	GΩ sec.
4	Voltage Proof	VP	Para. 9.4.1.4 $U_R \leq 1\ 250V$ $U_R > 1\ 250V$	1.5U _R 1.3U _R	- -	V

TABLE 3 - ELECTRICAL MEASUREMENTS AT HIGH AND LOW TEMPERATURES

No.	CHARACTERISTICS	SYMBOL	ESA/SCC 3009 TEST CONDITIONS	LIMITS		UNIT	NOTES
				MIN.	MAX.		
3	Insulation Resistance	Ri Ri x C	Para. 9.4.1.3 T _{amb} = +125 ± 3 °C C ≤ 10 000pF C > 10 000pF	10 100	- -	GΩ sec.	Note 1
5(i)	Temperature Characteristic $\Delta C/C = f(T)$	TCC	Para. 9.12 V _T = 0V V _T = 500V	-20 -30	+20 +50	%	5 parts for each capacitance value Notes 2 and 4
5(ii)	Temperature Characteristic $\Delta C/C = f(T)$	TCC	Para. 9.12 V _T = 0V V _T = 500V	-20 -30	+20 +50	%	5 parts for each fired ceramic lot Notes 3 and 4

NOTES

1. Single sample; Inspection Level S3; AQL = 2.5%.
2. Applicable to Level 'B' only.
3. Applicable to Level 'C' only.
4. If 1 failure out of 5 parts, then test 100%. 1% rejects maximum allowed in the case of 100% testing.

FIGURE 4 - CIRCUITS FOR ELECTRICAL MEASUREMENTS

Not applicable.

TABLE 4 - PARAMETER DRIFT VALUES

No.	CHARACTERISTICS	SYMBOL	SPEC. AND/OR TEST METHOD	TEST CONDITIONS	CHANGE LIMITS (Δ)	UNIT
1	Capacitance Change	$\Delta C/C$	As per Table 2	As per Table 2	± 10	%

TABLE 5 - CONDITIONS FOR BURN-IN AND OPERATING LIFE TESTS

No.	CHARACTERISTICS	SYMBOL	CONDITIONS	UNIT
1	Ambient Temperature	T_{amb}	+ 125 (+0 - 3)	°C
2	Test Voltage	V_T	$U_R \leq 1\ 250V - 1.3\ U_R$ $U_R > 1\ 250V - 1.0\ U_R$	V

FIGURE 5 - ELECTRICAL CIRCUIT FOR BURN-IN AND OPERATING LIFE TESTS

Not applicable.

	<p style="text-align: center;">ESA/SCC Detail Specification No. 3009/034</p>	<p>PAGE 13 ISSUE 1</p>
---	--	----------------------------

4.8 ENVIRONMENTAL AND ENDURANCE TESTS (CHARTS IV AND V OF ESA/SCC GENERIC SPECIFICATION No. 3009)

4.8.1 Measurements and Inspections on Completion of Environmental Tests

The parameters to be measured and inspections to be performed on completion of environmental tests are scheduled in Table 6. Unless otherwise stated, the measurements shall be performed at $T_{amb} = +22 \pm 3 \text{ }^\circ\text{C}$.

4.8.2 Measurements and Inspections at Intermediate Points during Endurance Tests

The parameters to be measured and inspections to be performed at intermediate points during endurance testing are scheduled in Table 6 of this specification. Unless otherwise stated, the measurements shall be performed at $T_{amb} = +22 \pm 3 \text{ }^\circ\text{C}$.

4.8.3 Measurements and Inspections on Completion of Environmental Tests

The parameters to be measured and inspections to be performed on completion of environmental testing are scheduled in Table 6 of this specification. Unless otherwise stated, the measurements shall be performed at $T_{amb} = +22 \pm 3 \text{ }^\circ\text{C}$.

4.8.4 Conditions for Operating Life Tests (Part of Endurance Testing)

The requirements for operating life testing are specified in Section 9 of ESA/SCC Generic Specification No. 3009. The conditions for operating life testing shall be the same as specified in Table 5 for the burn-in test.

4.8.5 Electrical Circuits for Operating Life Tests (Figure 5)

Not applicable.

TABLE 6 - MEASUREMENTS AND INSPECTIONS ON COMPLETION OF ENVIRONMENTAL TESTS AND AT INTERMEDIATE POINTS AND ON COMPLETION OF ENDURANCE TESTING

NO.	ESA/SCC GENERIC SPECIFICATION NO. 3009		MEASUREMENTS AND INSPECTIONS		SYMBOL	LIMITS		UNIT
	ENVIRONMENTAL AND ENDURANCE TESTS (1)	TEST METHOD AND CONDITIONS	IDENTIFICATION	CONDITIONS		MIN.	MAX.	
01	Mounting	Para. 9.15	Final Examination Terminals Final Measurements Capacitance Tangent of Loss Angle Insulation Resistance	Good Tinning Table 2 Item 1 Table 2 Item 2 Table 2 Item 3	- C T _{gδ} Ri	- Record Values Table 2 Item 2 Table 2 Item 3	- pF - -	
02	Visual Inspection	Para. 9.1	Visual Inspection	SCC No. 20400	-	-	-	
03	Adhesion	Para. 9.5	Final Examination Visual Examination Capacitance	No damage or loosening Table 2 Item 1	- C	- Table 2 Item 1	- -	
04	Solderability	Para. 9.6	Final Examination Visual Examination	Para. 9.6	-	-	-	
05	Rapid Change of Temperature	Para. 9.7	Initial Measurements Capacitance Final Measurements Visual Examination Capacitance Change Tangent of Loss Angle	Table 2 Item 1 Recovery period 24 ± 2 hrs No damage Table 2 Item 1 Table 2 Item 2	C - ΔC/C T _{gδ}	Item 01 Value - - 10 + 10 - (2)	pF - % -	
06	Climatic Test Sequence	Para. 9.8	Initial Measurements Capacitance Final Measurements Visual Inspection Capacitance Change Tangent of Loss Angle Insulation Resistance	Table 2 Item 1 Recovery period 1 to 24 hrs SCC No. 20400 Table 2 Item 1 Table 2 Item 2 Table 2 Item 3	C - ΔC/C T _{gδ} Ri	Item 01 Value - - 10 + 10 - (2) 3.0 (3)	pF - % - GΩ	
07	Damp Heat Steady State	Para. 9.9	Initial Measurements Capacitance Final Measurements Visual Examination Capacitance Change Tangent of Loss Angle Insulation Resistance	Table 2 Item 1 Recovery period 6 to 24 ± 2 hrs No damage Table 2 Item 2 Table 2 Item 3 Table 2 Item 3	C - ΔC/C T _{gδ} Ri	Item 01 Value - - 10 + 10 - (2) 3.0 (3)	pF - % - GΩ	

NOTES

1. The tests in this table refer to either Chart IV or V and shall be used as applicable.
2. Twice the value specified in Table 2 of this specification.
3. Or 30 seconds for C > 10 000pF.
4. Or 100 seconds for C > 10 000pF.

TABLE 6 - MEASUREMENTS AND INSPECTIONS ON COMPLETION OF ENVIRONMENTAL TESTS AND AT INTERMEDIATE POINTS AND ON COMPLETION OF ENDURANCE TESTING (CONT'D)

NO.	ESA/SCC GENERIC SPECIFICATION NO. 3009		MEASUREMENTS AND INSPECTIONS		SYMBOL	LIMITS		UNIT	
	ENVIRONMENTAL AND ENDURANCE TESTS (1)	TEST METHOD AND CONDITIONS	IDENTIFICATION	CONDITIONS		MIN.	MAX.		
08	Operating Life	Para. 9.10	Initial Measurements	Table 2 Item 1 To be performed at 1000 hrs (Chart IV)	C	Item 01 Value		pF	
			Intermediate Measurements						
			Capacitance Change		Table 2 Item 1	$\Delta C/C$	-15	+15	%
			Insulation Resistance		Table 2 Item 3	Ri	10 (4)	-	G Ω
			Final Measurements		Recovery Period 24 \pm 2 hrs				
			Capacitance Change		Table 2 Item 1	$\Delta C/C$	-15	+15	%
			Tangent of Loss Angle		Table 2 Item 2	T $_{gd}$	-	(2)	-
			Insulation Resistance		Table 2 Item 3	Ri	10 (4)	-	G Ω
	Voltage Proof	Table 2 Item 4	VP	Table 2 Item 4		V			
	Visual Examination	No damage	-	-	-	-			
09	Temperature Characteristic	Para. 9.12	Capacitance Changes	Table 3 Item 5(i) or 5(ii)	TCC	Table 3 Item 5(i) or 5(ii)		10 ⁻⁶ /°C	
10	Permanence of Marking	Para. 9.14	Visual Examination	Gen 3009 Para. 9.14	-	Para. 9.14		-	

NOTES

1. The tests in this table refer to either Chart IV or V and shall be used as applicable.
2. Twice the value specified in Table 2 of this specification.
3. Or 30 seconds for C > 10 000pF.
4. Or 100 seconds for C > 10 000pF.

**SCC**ESA/SCC Detail Specification
No. 3009/034

Rev. 'B'

PAGE 16

ISSUE 1

APPENDIX 'A'Page 1 of 1**AGREED DEVIATIONS FOR AVX LTD., COLERAINE (UK)**

ITEMS AFFECTED	DESCRIPTION OF DEVIATIONS
Para. 4.2.1	Microsectioning may be performed using AVX document COL/EMP/04-20 (Issue as per P.I.D.).