



europaean space agency
agence spatiale européenne

Pages 1 to 18

**DIODES, POWER,
SCHOTTKY BARRIER
BASED ON TYPE STPS20H100
ESA/SCC Detail Specification No. 5106/016**



**space components
coordination group**

Issue/Rev.	Date	Approved by	
		SCCG Chairman	ESA Director General or his Deputy
Issue 1	October 2000		
Revision 'A'	July 2002		



SCC

ESA/SCC Detail Specification
No. 5106/016

Rev. 'A'

PAGE 2

ISSUE 1

DOCUMENTATION CHANGE NOTICE

Rev. Letter	Rev. Date	Reference	CHANGE Item	Approved DCR No.
'A'	July '02	P1. Cover page P2. DCN P4. T of C P18. Appendix 'A'	: Page count incremented by 1 : "None" deleted and Appendix 'A' added : New page added	None None None 221672

**TABLE OF CONTENTS**

	<u>Page</u>
1. <u>GENERAL</u>	5
1.1 Scope	5
1.2 Component Type Variants	5
1.3 Maximum Ratings	5
1.4 Parameter Derating Information	5
1.5 Physical Dimensions	5
1.6 Functional Diagram	5
1.7 High Temperature Test Precautions	5
2. <u>APPLICABLE DOCUMENTS</u>	5
3. <u>TERMS, DEFINITIONS, ABBREVIATIONS, SYMBOLS AND UNITS</u>	5
4. <u>REQUIREMENTS</u>	11
4.1 General	11
4.2 Deviations from Generic Specification	11
4.2.1 Deviations from Special In-process Controls	11
4.2.2 Deviations from Final Production Tests	11
4.2.3 Deviations from Burn-in and Electrical Measurements	11
4.2.4 Deviations from Qualification Tests	11
4.2.5 Deviations from Lot Acceptance Tests	11
4.3 Mechanical Requirements	11
4.3.1 Dimension Check	11
4.3.2 Weight	11
4.3.3 Terminal Strength	11
4.4 Materials and Finishes	11
4.4.1 Case	12
4.4.2 Lead Material and Finish	12
4.5 Marking	12
4.5.1 General	12
4.5.2 Lead Identification	12
4.5.3 The SCC Component Number	12
4.5.4 Traceability Information	12
4.6 Electrical Measurements	12
4.6.1 Electrical Measurements at Room Temperature	12
4.6.2 Electrical Measurements at High and Low Temperatures	13
4.6.3 Circuits for Electrical Measurements	13
4.7 Burn-in Tests	13
4.7.1 Parameter Drift Values	13
4.7.2 Conditions for High Temperature Reverse Bias Burn-in	13
4.7.3 Conditions for Power Burn-in	13
4.7.4 Electrical Circuits for High Temperature Reverse Bias Burn-in	13
4.7.5 Electrical Circuits for Power Burn-in	13
4.8 Environmental and Endurance Tests	17
4.8.1 Electrical Measurements on Completion of Environmental Tests	17
4.8.2 Electrical Measurements at Intermediate Points and on Completion of Endurance Tests	17
4.8.3 Conditions for Operating Life Tests	17
4.8.4 Electrical Circuits for Operating Life Tests	17
4.8.5 Conditions for High Temperature Storage Test	17



TABLES



	<u>Page</u>
1(a) Type Variants	6
1(b) Maximum Ratings	6
2 Electrical Measurements at Room Temperature - d.c. Parameters	14
Electrical Measurements at Room Temperature - a.c. Parameters	14
3(a) Electrical Measurements at High Temperature	14
3(b) Electrical Measurements at Low Temperature	15
4 Parameter Drift Values	15
5(a) Conditions for High Temperature Reverse Bias Burn-in	16
5(b) Conditions for Power Burn-in and Operating Life Tests	16
6 Electrical Measurements at Intermediate Points and on Completion of Endurance Testing	17

FIGURES

1 Parameter Derating Information	7
2 Physical Dimensions	8
3 Functional Diagram	10
4 Circuits for Electrical Measurements	N/A
5(a) Electrical Circuit for High Temperature Reverse Bias Burn-in	N/A
5(b) Electrical Circuit for Power Burn-in and Operating Life Tests	N/A

APPENDICES (Applicable to specific Manufacturers only)

'A' Agreed Deviations for STMicroelectronics	18
--	----

		<p style="text-align: center;">ESA/SCC Detail Specification No. 5106/016</p>		<p>PAGE 5 ISSUE 1</p>
--	--	--	--	---------------------------

1. GENERAL

1.1 SCOPE

This specification details the ratings, physical and electrical characteristics, test and inspection data for Diodes, Power, Schottky Barrier, based on Type STPS20H100. It shall be read in conjunction with ESA/SCC Generic Specification No. 5000, the requirements of which are supplemented herein.

1.2 COMPONENT TYPE VARIANTS

Variants of the basic type diodes specified herein, which are also covered by this specification, are given in Table 1(a).

1.3 MAXIMUM RATINGS

The maximum ratings, which shall not be exceeded at any time during use or storage, applicable to the diodes specified herein, are as scheduled in Table 1(b).

1.4 PARAMETER DERATING INFORMATION

The applicable derating information for the diodes specified herein is shown in Figure 1.

1.5 PHYSICAL DIMENSIONS

The physical dimensions of the diodes specified herein are shown in Figure 2.

1.6 FUNCTIONAL DIAGRAM

The functional diagram, showing lead identification of the diodes specified herein, is shown in Figure 3.

1.7 HIGH TEMPERATURE TEST PRECAUTIONS

For tin-lead plated or solder-dipped lead finish, all tests to be performed at a temperature that exceeds +125°C shall be carried out in a 100% inert atmosphere.

2. APPLICABLE DOCUMENTS

The following documents form part of this specification and shall be read in conjunction with it:-

- (a) ESA/SCC Generic Specification No. 5000 for Discrete Semiconductors.
- (b) MIL-STD-750, Test Methods and Procedures for Semiconductor Devices.

3. TERMS, DEFINITIONS, ABBREVIATIONS, SYMBOLS AND UNITS

For the purpose of this specification, the terms, definitions, abbreviations, symbols and units specified in ESA/SCC Basic Specification No. 21300 shall apply. In addition, the following abbreviation is used:-

C_J = Junction Capacitance.

**TABLE 1(a) - TYPE VARIANTS**

VARIANT	BASED ON TYPE	CASE	FIGURE	LEAD MATERIAL AND FINISH
01	STPS20H100FSY	TO254	2(a)	H9
02	STPS20H100AFSY	TO254	2(a)	H9
03	STPS20H100CFSY	TO254	2(a)	H9
04	STPS20H100SFSY	TO254	2(a)	H9
05	STPS20H100N5	SMD.5	2(b)	P14

TABLE 1(b) - MAXIMUM RATINGS

No.	CHARACTERISTICS	SYMBOL	MAXIMUM RATINGS	UNIT	REMARKS
1	Forward Surge Current Per Diode	I_{FSM}	250	A	Note 1
2	Repetitive Peak Reverse Voltage	V_{RRM}	100	V	
3	Repetitive Peak Reverse Current	I_{RRM}	1.0	A	Note 2
4	Average Output Rectified Current Per Diode Per Device	I_O	20 40	A	$\delta = 0.5$ Note 3
5	RMS Forward Current Per Diode	$I_{F(RMS)}$	30	A	
6	Junction Temperature	T_J	+ 175	°C	
7	Storage Temperature Range	T_{stg}	- 55 to + 175	°C	
8	Soldering Temperature	T_{sol}	+ 260	°C	Note 4
9	Critical Rate of Rise of Reverse Voltage	dV/dt	10 000	V/ μ s	
10	Thermal Resistance (Junction to Case) Per Diode Total	$R_{TH(J-C)}$	1.65 0.85	°C/W	

NOTES

1. Sinusoidal, with period = 10ms.
2. Period 2.0 μ s, f = 1.0kHz.
3. At $T_{case} = +142^\circ\text{C}$. For derating at $T_{case} > +142^\circ\text{C}$, see Figure 1.
4. For Variants 01 to 04, duration 10 seconds maximum at a distance of not less than 1.5mm from the device body and the same lead shall not be resoldered until 3 minutes have elapsed.



FIGURE 1 - PARAMETER DERATING INFORMATION

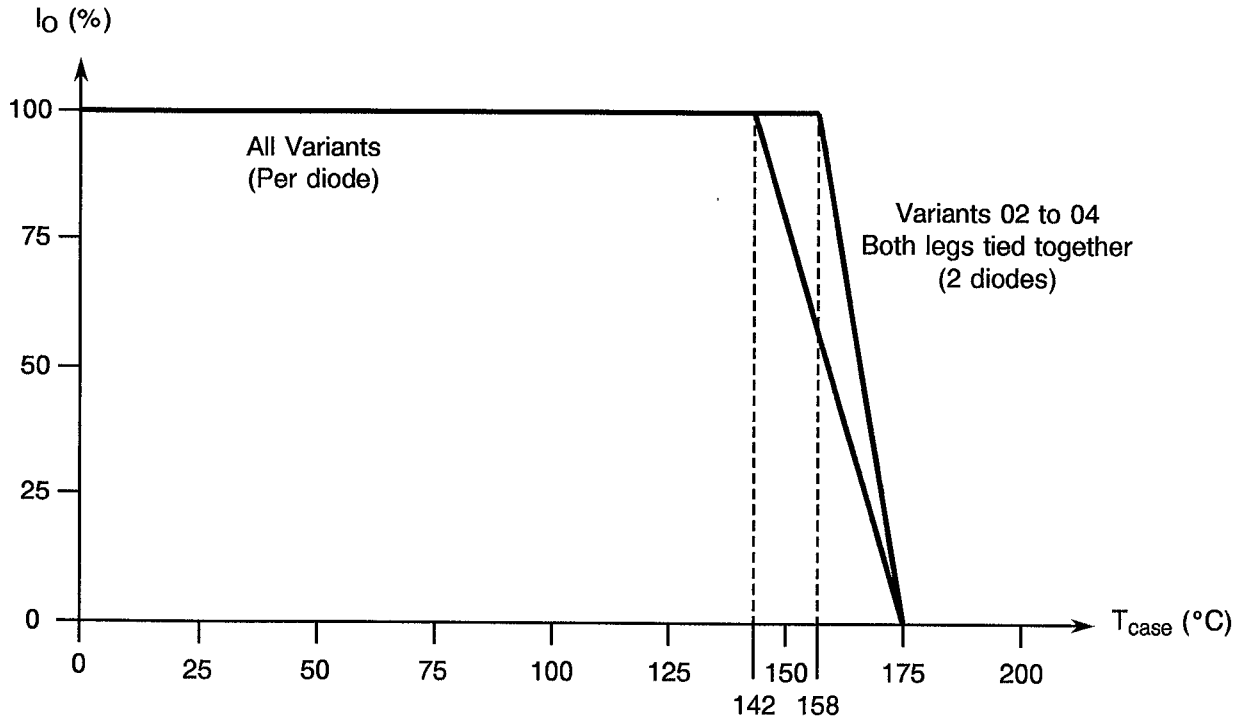

Average Output Rectified Current versus Temperature



FIGURE 2 - PHYSICAL DIMENSIONS

FIGURE 2(a) - VARIANTS 01 TO 04

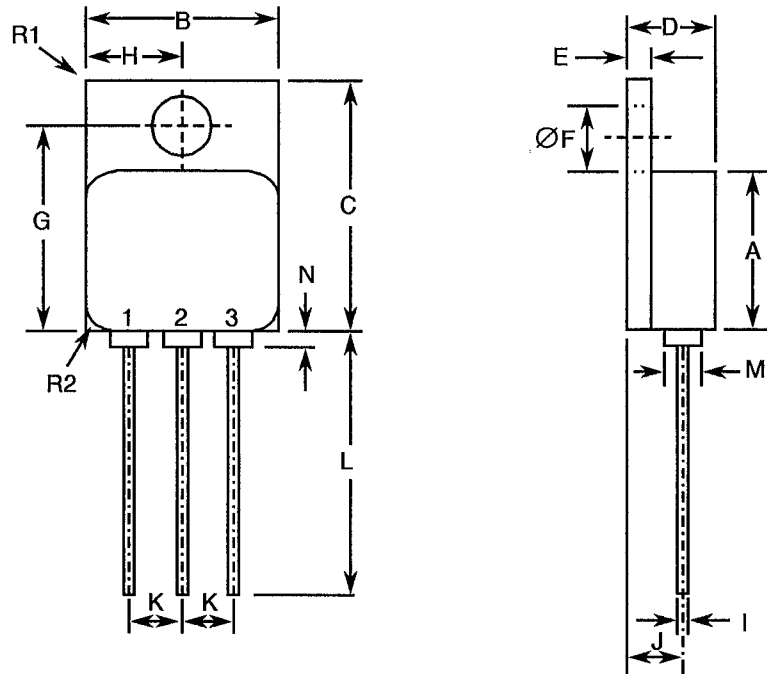

SYMBOL	MILLIMETRES	
	MIN.	MAX.
A	13.59	13.84
B	13.59	13.84
C	20.07	20.32
D	6.3	6.7
E	1.0	1.35
ØF	3.5	3.9
G	16.89	17.4
H	6.86 Typical	
I	0.89	1.14
J	3.81 Typical	
K	3.81 Typical	
L	12.95	14.5
M	3.05 Typical	
N	-	0.71
R1	-	1.0
R2	1.65 Typical	

NOTES

1. All terminals are isolated from case.



FIGURE 2 - PHYSICAL DIMENSIONS

FIGURE 2(b) - VARIANT 05

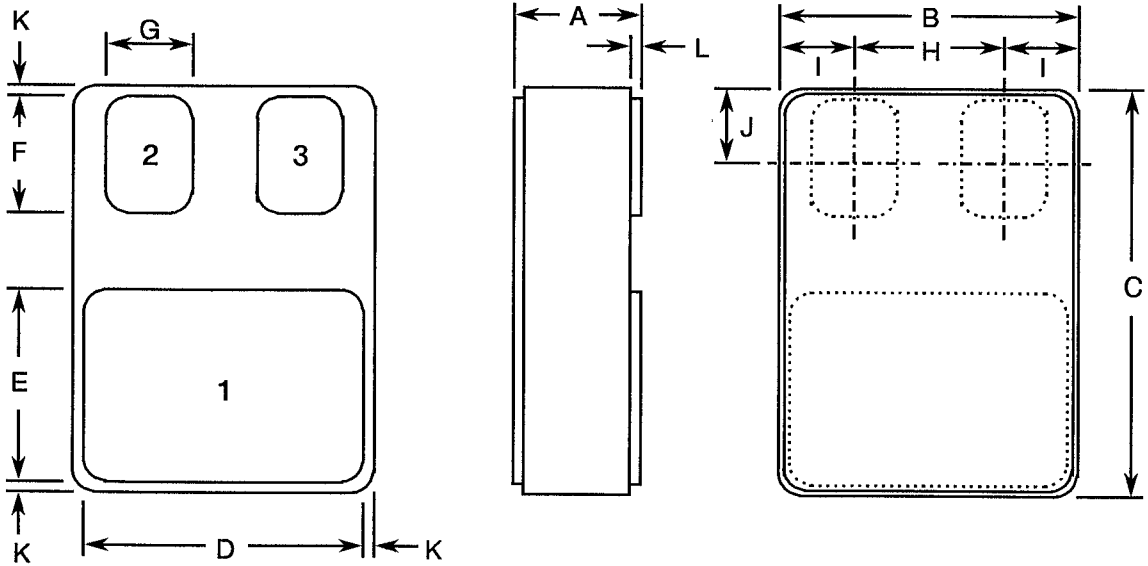

SYMBOL	MILLIMETRES	
	MIN.	MAX.
A	2.82	3.1
B	7.39	7.65
C	10.03	10.29
D	7.14	7.39
E	5.59	5.84
F	2.92	3.18
G	2.29	2.54
H	3.68	3.94
I	1.85 Typical	
J	2.11 Typical	
K	0.13 Typical	
L	0.38 Typical	



FIGURE 3 - FUNCTIONAL DIAGRAM

VARIANTS 01 TO 04

VARIANT 01

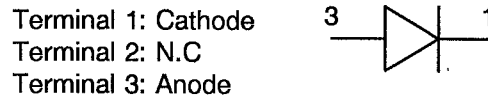

VARIANT 02

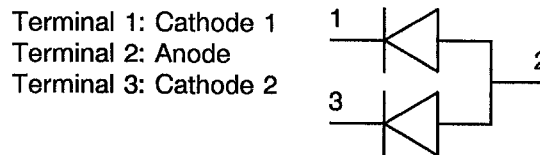

VARIANT 03

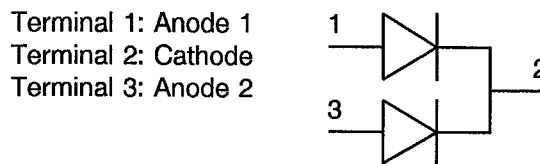

VARIANT 04

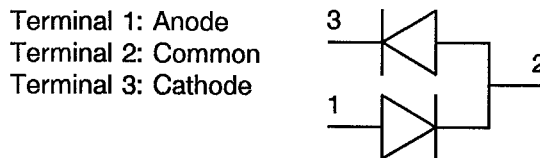

NOTES

1. All terminals are isolated from case.

VARIANT 05

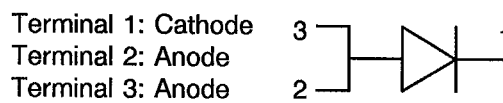



4. REQUIREMENTS

4.1 GENERAL

The complete requirements for procurement of the diodes specified herein shall be as stated in this specification and ESA/SCC Generic Specification No. 5000 for Discrete Semiconductors. Deviations from the Generic Specification, applicable to this specification only, are listed in Para. 4.2.

Deviations from the applicable Generic Specification and this Detail Specification, formally agreed with specific Manufacturers on the basis that the alternative requirements are equivalent to the ESA/SCC requirements and do not affect the components' reliability, are listed in the appendices attached to this specification.

4.2 DEVIATIONS FROM GENERIC SPECIFICATION

4.2.1 Deviations from Special In-process Controls

None.

4.2.2 Deviations from Final Production Tests (Chart II)

None.

4.2.3 Deviations from Burn-in and Electrical Measurements (Chart III)

(a) Para. 9.9.5, Safe Operating Area: Not applicable.

4.2.4 Deviations from Qualification Tests (Chart IV)

(a) Para. 9.15, Constant Acceleration: Not applicable.

(b) Para. 9.19, Terminal Strength: Not applicable for Variant 05.

4.2.5 Deviations from Lot Acceptance Tests (Chart V)

(a) Para. 9.15, Constant Acceleration: Not applicable.

(b) Para. 9.19, Terminal Strength: Not applicable for Variant 05.

4.3 MECHANICAL REQUIREMENTS

4.3.1 Dimension Check

The dimensions of the diodes specified herein shall be checked. They shall conform to those shown in Figure 2.

4.3.2 Weight

The maximum weight of the diodes specified herein shall be 10 grammes for Variants 01 to 04 and 2.0 grammes for Variant 05.

4.3.3 Terminal Strength

For Variants 01 to 04, the requirements for terminal strength testing are specified in Section 9 of ESA/SCC Generic Specification No. 5000. The test conditions shall be as follows:-

Test Condition: 'A' (Tension).

Applied Force: 10 Newtons.

Duration: 10 seconds.

4.4 MATERIALS AND FINISHES

The materials and finishes shall be as specified herein. Where a definite material is not specified, a material which will enable the diodes specified herein to meet the performance requirements of this specification shall be used. Acceptance or approval of any constituent material does not guarantee acceptance of the finished product.



4.4.1 Case

For Variants 01 to 04, the case shall be hermetically sealed and have a metal body. The Fe/Ni copper core pin shall pass through a ceramic eyelet brazed into the frame and the lid shall be welded.

For Variant 05, the case shall be hermetically sealed and have a ceramic body with kovar lid.

4.4.2 Lead Material and Finish

For Variants 01 to 04, the lead material shall be 'H' with Type '9' finish in accordance with the requirements of ESA/SCC Basic Specification No. 23500. (See Table 1(a) for Type Variants).

For Variant 05, the lead material shall be 'P' with Type '14' finish in accordance with the requirements of ESA/SCC Basic Specification No. 23500. (See Table 1(a) for Type Variants).

4.5 MARKING

4.5.1 General

The marking of all components delivered to this specification shall be in accordance with the requirements of ESA/SCC Basic Specification No. 21700 and the following paragraphs. When the component is too small to accommodate all of the marking specified, as much as space permits shall be marked and the marking information, in full, shall accompany the component in its primary package.

The information to be marked and the order of precedence, shall be as follows:-

- (a) Lead Identification.
- (b) The SCC Component Number.
- (c) Traceability Information.

4.5.2 Lead Identification

Lead identification shall be as shown in Figures 2 and 3 of this specification.

4.5.3 The SCC Component Number

Each component shall bear the SCC Component Number which shall be constituted and marked as follows:

510601601B

Detail Specification Number _____

Type Variant (See Table 1(a)) _____

Testing Level (B or C, as applicable) _____

4.5.4 Traceability Information

Each component shall be marked in respect of traceability information in accordance with the requirements of ESA/SCC Basic Specification No. 21700.

4.6 ELECTRICAL MEASUREMENTS

4.6.1 Electrical Measurements at Room Temperature

The parameters to be measured at room temperature are scheduled in Table 2. Unless otherwise stated, the measurements shall be performed at $T_{amb} = +22 \pm 3 \text{ }^\circ\text{C}$.



4.6.2 Electrical Measurements at High and Low Temperatures

The parameters to be measured at high and low temperatures are scheduled in Table 3. Unless otherwise specified, the measurements in Table 3(a) shall be performed at $T_{\text{case}} = +125(+0-5)^\circ\text{C}$ and the measurement in Table 3(b) at $T_{\text{case}} = -55(+5-0)^\circ\text{C}$.

4.6.3 Circuits for Electrical Measurements (Figure 4)

Not applicable.

4.7 BURN-IN TESTS

4.7.1 Parameter Drift Values

The parameter drift values applicable to burn-in are specified in Table 4 of this specification. Unless otherwise stated, measurements shall be performed at $T_{\text{amb}} = +22 \pm 3^\circ\text{C}$. The parameter drift values (Δ) applicable to the parameters scheduled, shall not be exceeded. In addition to these drift value requirements, the appropriate limit value specified for a given parameter in Table 2 shall not be exceeded.

4.7.2 Conditions for High Temperature Reverse Bias Burn-in

Not applicable.

4.7.3 Conditions for Power Burn-in

The requirements for power burn-in are specified in Section 7 of ESA/SCC Generic Specification No. 5000. The conditions for power burn-in shall be as specified in Table 5(b) of this specification.

4.7.4 Electrical Circuits for High Temperature Reverse Bias Burn-in (Figure 5(a))

Not applicable.

4.7.5 Electrical Circuits for Power Burn-in (Figure 5(b))

Not applicable.

**TABLE 2 - ELECTRICAL MEASUREMENTS AT ROOM TEMPERATURE - d.c. PARAMETERS**

No.	CHARACTERISTICS	SYMBOL	MIL-STD-750 TEST METHOD	TEST CONDITIONS (NOTE 1)	LIMITS		UNIT
					MIN.	MAX.	
1	Forward Voltage Drop 1	V_{F1}	4011	$I_F = 10A$ (Note 2)	-	0.78	V
2	Forward Voltage Drop 2	V_{F2}	4011	$I_F = 20A$ (Note 2)	-	1.0	V
3	Reverse Current	I_R	4016	D.C. Method $V_R = V_{RWM} = -100V$	-	30	μA

NOTES

- Measurements per each diode.
- Pulsed measurement: Pulse Width $\leq 300\mu s$, Duty Cycle $\leq 2.0\%$.

TABLE 2 - ELECTRICAL MEASUREMENTS AT ROOM TEMPERATURE - a.c. PARAMETERS

No.	CHARACTERISTICS	SYMBOL	MIL-STD-750 TEST METHOD	TEST CONDITIONS	LIMITS		UNIT
					MIN.	MAX.	
4	Junction Capacitance	C_J	4001	$V_R = -10V$ $f = 1.0MHz$	-	700	pF
5	Thermal Impedance	$Z_{TH(J-C)}$	3101	$I_H = 15$ to $40A$ $t_H = 50ms$ $I_M = 50mA$ $t_{md} = 100\mu s$ (Note 2)	-	1.0	$^{\circ}C/W$

NOTES

- Measurements per each diode.
- During Chart II only, go-no-go.

TABLE 3(a) - ELECTRICAL MEASUREMENTS AT HIGH TEMPERATURES

No.	CHARACTERISTICS	SYMBOL	MIL-STD-750 TEST METHOD	TEST CONDITIONS (NOTE 1)	LIMITS		UNIT
					MIN.	MAX.	
2	Forward Voltage Drop 2	V_{F2}	4011	$I_F = 20A$ (Note 2)	-	0.9	V
3	Reverse Current	I_R	4016	D.C. Method $V_R = V_{RWM} = -100V$	-	20	mA

NOTES

- Measurements per each diode.
- Pulsed measurement: Pulse Width $\leq 300\mu s$, Duty Cycle $\leq 2.0\%$.

TABLE 3(b) - ELECTRICAL MEASUREMENTS AT LOW TEMPERATURE

No.	CHARACTERISTICS	SYMBOL	MIL-STD-750 TEST METHOD	TEST CONDITIONS (NOTE 1)	LIMITS		UNIT
					MIN.	MAX.	
2	Forward Voltage Drop 2	V_{F2}	4011	$I_F = 20A$ (Note 2)	-	1.1	V

NOTES

- Measurements per each diode.
- Pulsed measurement: Pulse Width $\leq 300\mu s$, Duty Cycle $\leq 2.0\%$.

FIGURE 4 - CIRCUITS FOR ELECTRICAL MEASUREMENTS

Not applicable.

TABLE 4 - PARAMETER DRIFT VALUES

No.	CHARACTERISTICS	SYMBOL	SPEC. AND/OR TEST METHOD	TEST CONDITIONS	CHANGE LIMIT (Δ)	UNIT
1	Forward Voltage Drop 1	V_{F1}	As per Table 2	As per Table 2	± 10	mV
3	Reverse Current	I_R	As per Table 2	As per Table 2	± 4.0 or (1) ± 100	μA %

NOTES

- Whichever is greater, referred to the initial value.

TABLE 5(a) - CONDITIONS FOR HIGH TEMPERATURE REVERSE BIAS BURN-IN

Not applicable.

TABLE 5(b) - CONDITIONS FOR BURN-IN AND OPERATING LIFE TESTS

No.	CHARACTERISTICS	SYMBOL	CONDITION	UNIT
1	Maximum Junction Temperature	T_J	+ 150	°C
2	Reverse Voltage	V_R	- 80	V
3	Average Output Rectified Current	I_O	0	A
4	Reverse Current	I_R	Note 1	

NOTES

- To evaluate the reverse losses, use the following equation:-

$$P = V_R \cdot I_R.$$

$$\text{With } I_{R(T_J = +175^\circ\text{C})} = I_{R(T_{J1})} \text{ Exp } (-0.054 * (T_{J1} - T_{J = +175^\circ\text{C}})).$$

FIGURE 5(a) - ELECTRICAL CIRCUIT FOR HIGH TEMPERATURE REVERSE BIAS BURN-IN

Not applicable.

FIGURE 5(b) - ELECTRICAL CIRCUIT FOR BURN-IN AND OPERATING LIFE TESTS

Not applicable.

4.8 ENVIRONMENTAL AND ENDURANCE TESTS (CHARTS IV AND V OF ESA/SCC GENERIC SPECIFICATION NO. 5000)

4.8.1 Electrical Measurements on Completion of Environmental Tests

The parameters to be measured on completion of environmental tests are scheduled in Table 2. Unless otherwise stated, the measurements shall be performed at $T_{amb} = +22 \pm 3$ °C.

4.8.2 Electrical Measurements at Intermediate Points and on Completion of Endurance Tests

The parameters to be measured at intermediate points and on completion of endurance tests are scheduled in Table 6 of this specification. Unless otherwise stated, the measurements shall be performed at $T_{amb} = +22 \pm 3$ °C.

4.8.3 Conditions for Operating Life Tests (Part of Endurance Testing)

The requirements for operating life testing are specified in Section 9 of ESA/SCC Generic Specification No. 5000. The conditions for operating life testing shall be the same as specified in Table 5(b) for the power burn-in.

4.8.4 Electrical Circuits for Operating Life Tests (Figure 5(b))



Not applicable.

4.8.5 Conditions for High Temperature Storage Test (Part of Endurance Testing)

The requirements for the high temperature storage test are specified in Section 9 of ESA/SCC Generic Specification No. 5000. The temperature to be applied shall be the maximum storage temperature specified in Table 1(b) of this specification.

TABLE 6 - ELECTRICAL MEASUREMENTS AT INTERMEDIATE POINTS AND ON COMPLETION OF ENDURANCE TESTING

No.	CHARACTERISTICS	SYMBOL	SPEC. AND/OR TEST METHOD	TEST CONDITIONS	LIMITS		UNIT
					MIN.	MAX.	
1	Forward Voltage Drop 1	V_{F1}	As per Table 2	As per Table 2	-	0.78	V
3	Reverse Current	I_R	As per Table 2	As per Table 2	-	30	μA

		<p>ESA/SCC Detail Specification No. 5106/016</p>	<p>Rev. 'A'</p>	<p>PAGE 18 ISSUE 1</p>
--	--	--	-----------------	----------------------------

APPENDIX 'A'

Page 1 of 1

AGREED DEVIATIONS FOR STMicroelectronics (F)

ITEMS AFFECTED	DESCRIPTION OF DEVIATIONS
Para. 4.2.2	Para. 9.1 Internal Visual Inspection: Wedge bonds equal to 1.1 wire diameters are acceptable for bonding with a V-Groove tool.