



europaean space agency  
agence spatiale européenne

Pages 1 to 18

**POWER DIVIDERS, UNSEALED 4-PORT  
QUADRATURE, 3dB, SMA CONNECTORS,  
0.1 - 18 GHz**

**BASED ON TYPE R433\*11600**

**ESA/SCC Detail Specification No. 3404/001**





**space components  
coordination group**

Issue/Rev.	Date	Approved by	
		SCCG Chairman	ESA Director General or his Deputy
Issue 2	April 1996	<i>Pommes</i>	<i>Aloum</i>



**DOCUMENTATION CHANGE NOTICE**

Rev. Letter	Rev. Date	Reference	CHANGE Item	Approved DCR No.
			This Issue supersedes Issue 1 and incorporates all modifications defined in Revisions 'A', 'B' and 'C' to Issue 1 and the changes agreed in the following DCR's:-	
		Cover Page		None
		DCN		None
		Para. 2	: Second document Title corrected	23760
		Table 1(b)	: No. 1, Remarks replaced by "Note 1"	23760
			: Nos. 3 and 4, Renumbered as "6" and "7" and all subsequent items renumbered	23760
			: New Note 1 added	23760
		Figure 1	: Derating curves combined	23760
		Figure 2	: Connector mounting screws added	23760
		Figure 3	: Symbol explanation added	23760
		Figure 4	: Moved to follow Table 3	23760
		Para. 4.2.4	: Title amended	23760
			: Deviation for R.F. Leakage deleted	23760
		Para. 4.3.1	: "9.4" amended to "9.18"	23760
		Para. 4.5.1	: Text amended	23760
		Para. 4.5.2	: "as applicable" deleted and "See Para. 4.4.1" added	23760
		Para. 4.7.2	: In second sentence, "5" amended to "5(a)"	23760
		Table 2	: Symbols added	23760
		Table 3	: Symbol added	23760
		Table 4	: Nos. 1 and 2 renumbered as "3" and "7"	23760
			: No. 1, Symbol added	23760
		Table 5	: Renumbered as "5(a)"	23760
		Table 5(b)	: Transferred from redundant Table 7	23760
		Figure 5	: Entry added	23760
		Paras 4.8.1 to 4.8.3	: Paragraphs standardised	23760
		Paras 4.8.4 to 4.8.6	: Paragraphs added	23760
		Table 6	: Expanded and reformatted	23760
		Table 7	: Deleted and transferred to Table 5(b)	23760

 	<p style="text-align: center;">ESA/SCC Detail Specification No. 3404/001</p>		<p>PAGE 3 ISSUE 2</p>
---	--	--	---------------------------

## TABLE OF CONTENTS

		<u>Page</u>
<b>1.</b>	<b><u>GENERAL</u></b>	<b>5</b>
1.1	Scope	5
1.2	Component Type Variants and Range of Components	5
1.3	Maximum Ratings	5
1.4	Parameter Derating Information	5
1.5	Physical Dimensions	5
1.6	Functional Diagram	5
1.7	Storage Precautions	5
<b>2.</b>	<b><u>APPLICABLE DOCUMENTS</u></b>	<b>5</b>
<b>3.</b>	<b><u>TERMS, DEFINITIONS, ABBREVIATIONS, SYMBOLS AND UNITS</u></b>	<b>5</b>
<b>4.</b>	<b><u>REQUIREMENTS</u></b>	<b>10</b>
4.1	General	10
4.2	Deviations from Generic Specification	10
4.2.1	Deviations from Special In-process Controls	10
4.2.2	Deviations from Final Production Tests	10
4.2.3	Deviations from Burn-in and Electrical Measurements	10
4.2.4	Deviations from Qualification Tests	10
4.2.5	Deviations from Lot Acceptance Tests	10
4.3	Mechanical Requirements	10
4.3.1	Dimension Check	10
4.3.2	Weight	10
4.3.3	Female Contact Retention	10
4.4	Materials and Finishes	11
4.4.1	Connector Receptacle	11
4.4.2	Body	11
4.5	Marking	11
4.5.1	General	11
4.5.2	The SCC Component Number	11
4.5.3	Characteristics	12
4.5.4	Traceability Information	12
4.6	Electrical Measurements	12
4.6.1	Electrical Measurements at Room Temperature	12
4.6.2	Electrical Measurements at High and Low Temperatures	13
4.6.3	Circuits for Electrical Measurements	13
4.7	Burn-in Tests	13
4.7.1	Parameter Drift Values	13
4.7.2	Conditions for Burn-in	13
4.7.3	Electrical Circuit for Burn-in	13
4.8	Environmental and Endurance Tests	16
4.8.1	Measurements and Inspections on Completion of Environmental Tests	16
4.8.2	Measurements and Inspections at Intermediate Points during Endurance Tests	16
4.8.3	Measurements and Inspections on Completion of Endurance Tests	16
4.8.4	Conditions for Operating Life Tests	16
4.8.5	Electrical Circuit for Operating Life Tests	16
4.8.6	Conditions for High Temperature Storage Test	16

		<p>ESA/SCC Detail Specification No. 3404/001</p>	<p>PAGE 4 ISSUE 2</p>
---	---	--	---------------------------

**TABLES**

	<u>Page</u>
1(a) Range of Components	6
1(b) Maximum Ratings	6
2 Electrical Measurements at Room Temperature	14
3 Electrical Measurements at High and Low Temperatures	14
4 Parameter Drift Values	15
5(a) Conditions for Burn-in	15
5(b) Conditions for Operating Life Tests	15
6 Measurements and Inspections on Completion of Environmental Tests and at Intermediate Points and on Completion of Endurance Testing	17

**FIGURES**

1 Parameter Derating Information	7
2 Physical Dimensions	8
3 Functional Diagram	9
4 Test Weight Configuration	14
5 Electrical Circuit for Burn-in and Operating Life Tests	15

**APPENDICES (Applicable to specific Manufacturers only)**

None.

**1. GENERAL****1.1 SCOPE**

This specification details the ratings, physical and electrical characteristics, test and inspection data for Power Dividers, Unsealed, 4-Port Quadrature, 3dB SMA Connectors in the frequency range 0.1 - 18 GHz, based on Type R433\*11600. It shall be read in conjunction with ESA/SCC Generic Specification No. 3404, the requirements of which are supplemented herein.

**1.2 COMPONENT TYPE VARIANTS AND RANGE OF COMPONENTS**

The component type variants covered by this specification are given in Para. 4.4.1. Table 1(a) lists the range of components covered.

**1.3 MAXIMUM RATINGS**

The maximum ratings, which shall not be exceeded at any time during use or storage, applicable to the power dividers specified herein, are scheduled in Table 1(b).

**1.4 PARAMETER DERATING INFORMATION**

The derating information applicable to the power dividers specified herein is shown in Figure 1.

**1.5 PHYSICAL DIMENSIONS**

The physical dimensions of the power dividers specified herein, are shown in Figure 2.

**1.6 FUNCTIONAL DIAGRAM**

The functional diagram of the power dividers specified herein, is shown in Figure 3.

**1.7 STORAGE PRECAUTIONS**

These components being unsealed require protection against humidity as specified in Para. 4.2 of ESA/SCC Basic Specification No. 20600.

**2. APPLICABLE DOCUMENTS**

The following documents form part of this specification and shall be read in conjunction with it:-

- (a) ESA/SCC Generic Specification No. 3404, Power Dividers, Couplers, RF Coaxial.
- (b) ESA/SCC Detail Specification No. 3402/002, RF Coaxial Connectors, Type SMA (Female Contact).

**3. TERMS, DEFINITIONS, ABBREVIATIONS, SYMBOLS AND UNITS**

For the purpose of this specification, the terms, definitions, abbreviations, symbols and units specified in ESA/SCC Basic Specification No. 21300 shall apply.

**TABLE 1(a) - RANGE OF COMPONENTS**

FREQUENCY RANGE (NOTE 1) (GHz)	CODE LETTER	INSERTION LOSS (dB)	VSWR	MINIMUM ISOLATION (dB)	PHASE BALANCE (90°)	AMPLITUDE BALANCE (dB)
1.8 - 2.5 (2)	N	0.25	1.20	21	±1.5	±0.4
3.7 - 4.2	E	0.30	1.25	21	±1.5	±0.4
5.9 - 6.4	J	0.30	1.25	20	±1.5	±0.4
7.25 - 7.75	L	0.30	1.30	18	±3.0	±0.4
8.2 - 8.45	D	0.30	1.25	20	±3.0	±0.4
7.9 - 8.4	M	0.40	1.30	18	±3.0	±0.4
11.7 - 12.1	F	0.40	1.30	18	±3.0	±0.4
12.5 - 12.7	G	0.40	1.30	18	±3.0	±0.4
14.0 - 14.25	H	0.45	1.35	17	±3.0	±0.4

**NOTES**

- Additional frequency ranges may be specified within the 0.1 - 18 GHz range.
- Temperature range: - 120 to + 125 °C (different technology).

**TABLE 1(b) - MAXIMUM RATINGS**

No.	CHARACTERISTICS	SYMBOL	MAXIMUM RATINGS	UNIT	REMARKS
1	Input Power	$P_{IN}$	50	W	Note 1
2	Peak Power	$P_P$	250	W	For 1.0µs 1/1000 cyclic ratio
3	Frequency Range	F	0.1 to 18	GHz	
4	Impedance	Z	50	Ω	
5	RF Leakage	-	80 - F GHz	dB	
6	Operating Temperature Range	$T_{op}$	- 40 to + 100	°C	Note 2
7	Storage Temperature Range	$T_{stg}$	- 55 to + 125	°C	Note 2

**NOTES**

- At  $T_{amb} \leq +25^\circ\text{C}$ . For derating at  $T_{amb} > +25^\circ\text{C}$ , see Figure 1.
- Frequency Range 'N': - 120 to + 125 °C.



**FIGURE 1 - PARAMETER DERATING INFORMATION**

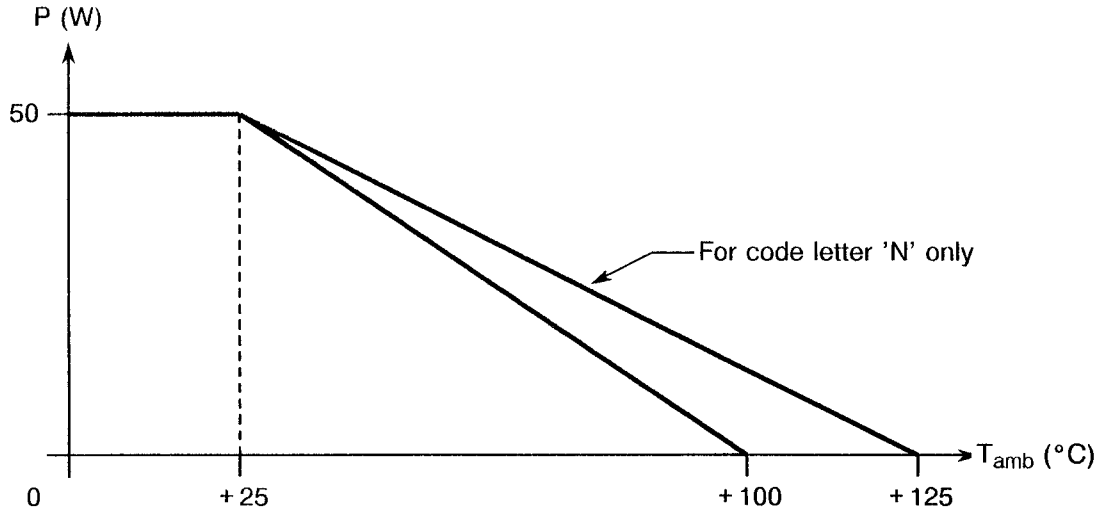

Rated Power versus Temperature



**FIGURE 2 - PHYSICAL DIMENSIONS**

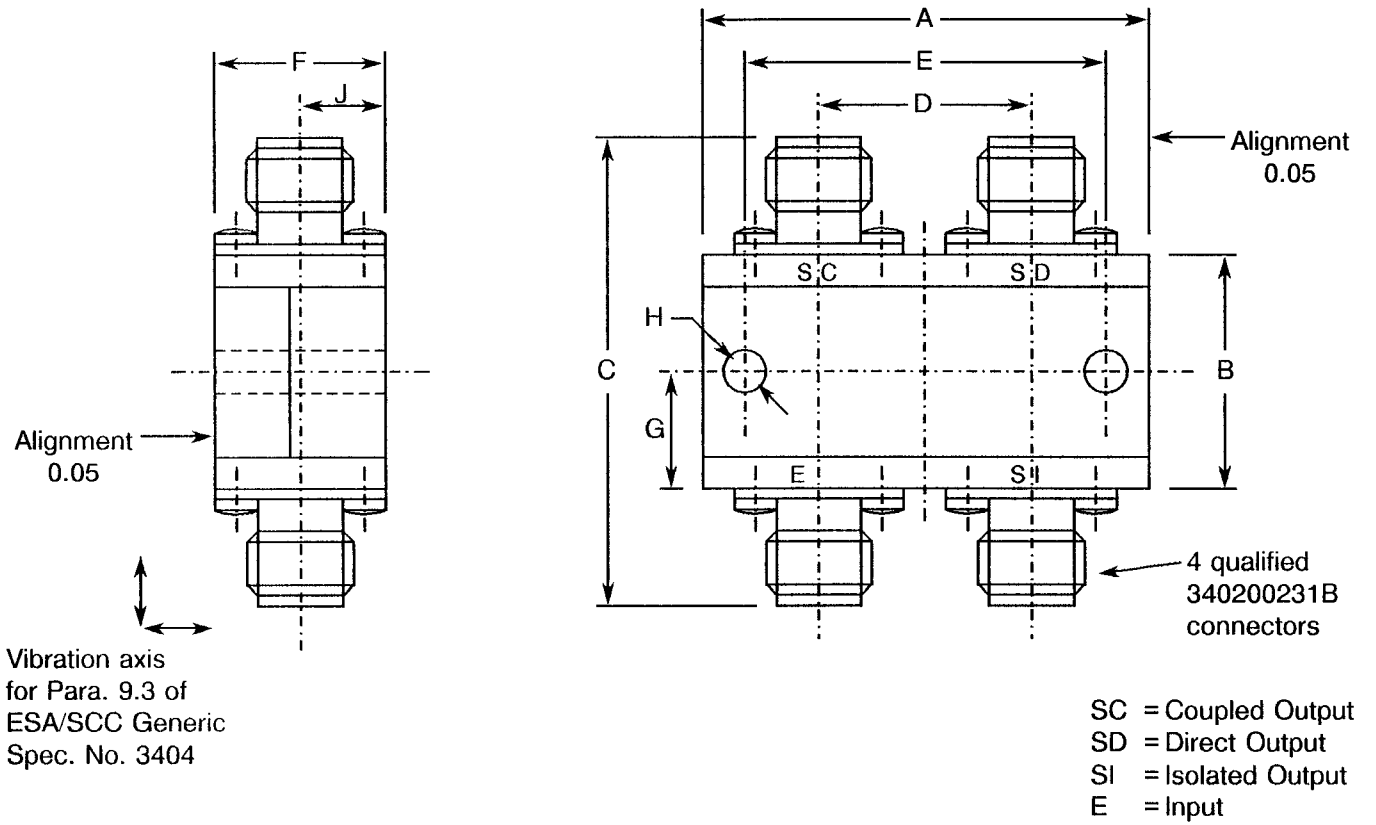

SYMBOL	MILLIMETRES		NOTES
	MIN.	MAX.	
A	-	32.5	Code Letter 'N' All Other Code Letters
B	17.8	18.2	
C	36.5	37.5	
D	15.8 12.5	16.2 12.9	
E	24.8	25.2	
F	-	12.9	
G	8.8	9.2	
H	2.6	3.0	
J	6.15	6.55	





**FIGURE 3 - FUNCTIONAL DIAGRAM**

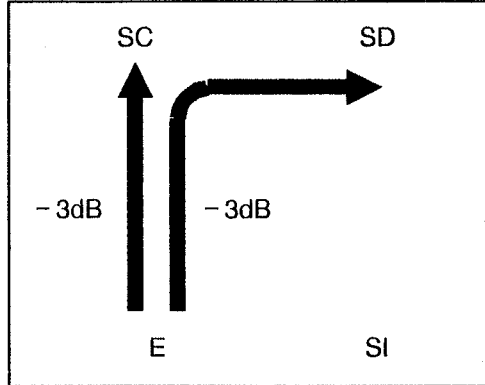

- E = Input.
- SC = Coupled Output.
- SD = Direct Output.
- SI = Isolated Output.



#### 4. REQUIREMENTS

##### 4.1 GENERAL

The complete requirements for procurement of the components specified herein are as stated in this specification and ESA/SCC Generic Specification No. 3404 for Power Dividers, Couplers, RF, Coaxial. Deviations from the Generic Specification, applicable to this specification only, are listed in Para. 4.2.

Deviations from the applicable Generic Specification and this Detail Specification, formally agreed with specific Manufacturers on the basis that the alternative requirements are equivalent to the ESA/SCC requirements and do not affect the components' reliability, are listed in the appendices attached to this specification.

##### 4.2 DEVIATIONS FROM GENERIC SPECIFICATION

###### 4.2.1 Deviations from Special In-process Controls

None.

###### 4.2.2 Deviations from Final Production Tests (Chart II)

None.

###### 4.2.3 Deviations from Burn-in and Electrical Measurements (Chart III)

None.

###### 4.2.4 Deviations from Qualification Tests (Chart IV)

(a) Para's 9.10.3 and 9.10.6, Damp Heat: Not applicable.

(b) Para. 9.11, Corrosion: Not applicable.

###### 4.2.5 Deviations from Lot Acceptance Tests (Chart V)

(a) Para's. 9.10.3 and 9.10.6, Damp Heat: Not applicable.

##### 4.3 MECHANICAL REQUIREMENTS

###### 4.3.1 Dimension Check

The dimensions of the power dividers specified herein shall be verified in accordance with the requirements set out in Para. 9.18 of ESA/SCC Generic Specification No. 3404 and shall conform to those shown in Figure 2.

###### 4.3.2 Weight

The maximum weight of the power dividers specified herein shall be 36 grammes.

###### 4.3.3 Female Contact Retention

The requirements for this test are specified in Section 9 of ESA/SCC Generic Specification No. 3404 and apply to female contacts only.

Female contacts shall be capable of lifting a weight of 42 grammes and the pin of such weight shall have the dimensions specified in Figure 4.

4.4 MATERIALS AND FINISHES

The materials and finishes shall be as specified herein. Where a definite material is not specified, a material which will enable the power dividers specified herein to meet the performance requirements of this specification shall be used. Acceptance or approval of any constituent material does not guarantee acceptance of the finished product.

4.4.1 Connector Receptacle

4.4.1.1 Variant 01

Beryllium copper, copper underplate, gold-plated as per ESA/SCC Detail Specification No. 3402/002.

4.4.1.2 Variant 02

Beryllium copper, nickel underplate, gold-plated as per ESA/SCC Detail Specification No. 3402/002.

4.4.1.3 Variant 03

Stainless steel as per ESA/SCC Detail Specification No. 3402/002.

4.4.1 Body

4.4.2.1 Package

Aluminium with Alodine 1200 surface treatment.

4.4.2.2 Lids

Aluminium, gold-plated 2.5 microns minimum over chemical nickel.

4.5 MARKING

4.5.1 General

The marking of all components delivered to this specification shall be in accordance with the requirements of ESA/SCC Basic Specification No. 21700 and the following paragraphs. When the component is too small to accommodate all of the marking specified, as much as space permits shall be marked and the marking information, in full, shall accompany the component in its primary package.

The information to be marked and the order of precedence, shall be as follows:-

- (a) The SCC Component Number.
- (b) Characteristics.
- (c) Traceability Information.

4.5.2 The SCC Component Number

Each component shall bear the SCC Component Number which shall be constituted and marked as follows:

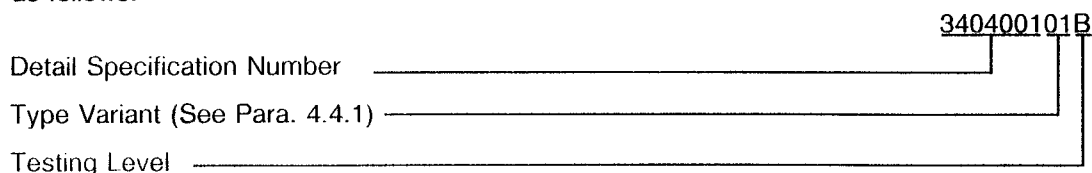



4.5.3 Characteristics

The characteristics to be marked in the following order of precedence are:-

- (a) Coupling.
- (b) Frequency Range.

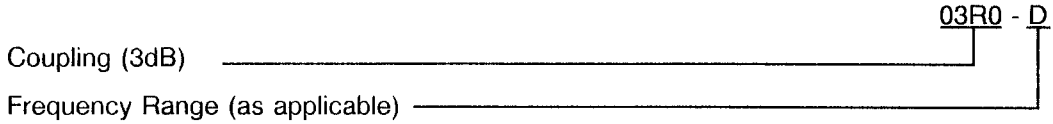

4.5.3.1 Coupling Values

Coupling values shall be expressed according to the following codes. The unit quantity for marking shall be decibels (dB).

Numerical Value	Code
X	0XR0
XX	XXR0

4.5.3.2 Frequency Range

Frequency ranges shall be expressed according to the following codes:-

Code Letter	Frequency Range (GHz)
D	8.2 - 8.45
E	3.7 - 4.2
F	11.7 - 12.1
G	12.5 - 12.7
H	14.0 - 14.25
J	5.9 - 6.4
L	7.25 - 7.75
M	7.9 - 8.4
N	1.8 - 2.5

4.5.4 Traceability Information

Each component shall be marked in respect of traceability information in accordance with the requirements of ESA/SCC Basic Specification No. 21700.

4.6 ELECTRICAL MEASUREMENTS

4.6.1 Electrical Measurements at Room Temperature

The parameters to be measured in respect of electrical characteristics are scheduled in Table 2. Unless otherwise specified, the measurements shall be performed at  $T_{amb} = +22 \pm 3$  °C.



#### 4.6.2 Electrical Measurements at High and Low Temperatures

The parameters to be measured at high and low temperatures are scheduled in Table 3.

#### 4.6.3 Circuits for Electrical Measurements

Circuits for use in performing electrical measurements are given in ESA/SCC Generic Specification No. 3404.

### 4.7 BURN-IN TESTS

#### 4.7.1 Parameter Drift Values

The parameter drift values applicable to burn-in are specified in Table 4 of this specification. Unless otherwise stated, measurements shall be performed at  $T_{amb} = +22 \pm 3$  °C. The parameter drift values ( $\Delta$ ) applicable to the parameters scheduled shall not be exceeded. In addition to these drift value requirements for a given parameter, the appropriate limit value specified in Table 2 shall not be exceeded.

#### 4.7.2 Conditions for Burn-in

The requirements for burn-in are specified in Section 7 of ESA/SCC Generic Specification No. 3404. The conditions for burn-in shall be as specified in Table 5(a) of this specification.

On completion of burn-in, a recovery period of  $24 \pm 2$  hours is necessary before performance of the end-measurements.

#### 4.7.3 Electrical Circuit for Burn-in (Figure 5)

Not applicable.



**TABLE 2 - ELECTRICAL MEASUREMENTS AT ROOM TEMPERATURE**

No.	CHARACTERISTICS	SYMBOL	ESA/SCC 3404 TEST METHOD AND CONDITION	LIMITS		UNIT
				MIN.	MAX.	
1	VSWR	RL	Para. 9.5.1.2.4	See Table 1(a)		
2	Average Coupling	AVc	Para. 9.5.1.2.1	-3.2	-3.0	dB
3	Amplitude Balance	AMb	Para. 9.5.1.2.2	-0.4	+0.4	dB
4	Phase Balance	PHb	Para. 9.5.1.2.3	See Table 1(a)		°
5	Isolation	ISO	Para. 9.5.1.2.6	See Table 1(a)		dB
6	Insertion Loss	IL	Para. 9.5.1.2.5	See Table 1(a)		dB

**TABLE 3 - ELECTRICAL MEASUREMENTS AT HIGH AND LOW TEMPERATURES**

No.	CHARACTERISTICS	SYMBOL	ESA/SCC 3404 TEST METHOD AND CONDITION	LIMITS		UNIT
				MIN.	MAX.	
3	Amplitude Balance	AMb	Para. 9.5.1.2.2	-0.4	+0.4	dB

**FIGURE 4 - TEST WEIGHT CONFIGURATION**

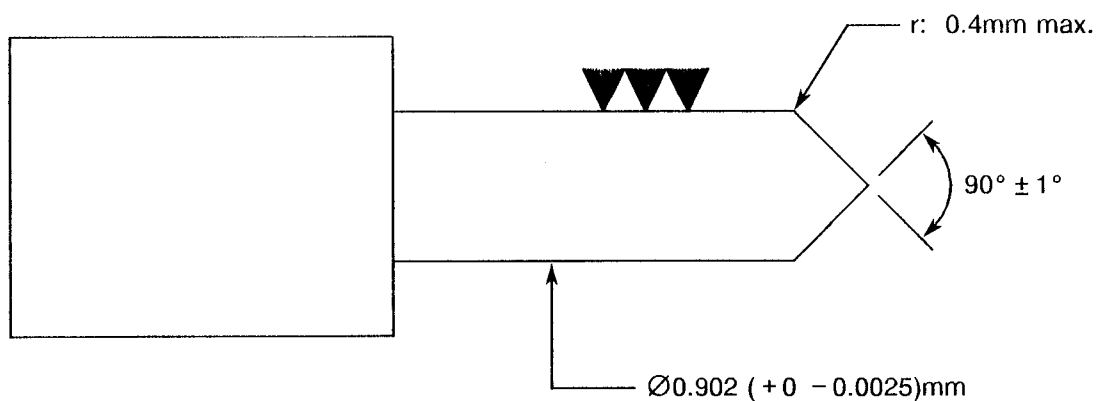

**TABLE 4 - PARAMETER DRIFT VALUES**

No.	CHARACTERISTICS	SYMBOL	SPEC. AND/OR TEST METHOD	TEST CONDITIONS	CHANGE LIMITS ( $\Delta$ )	UNIT
3	Amplitude Balance Drift	$\frac{\Delta AMb}{AMb}$	As per Table 2	As per Table 2	$\pm 0.1$	dB
7	Contact Resistance Drift	$\frac{\Delta RC}{RC}$	Note 1	Note 1	120	%

**NOTES**

1. Contact resistance shall be measured between E and SD and between SI and SC, using a 4-wire Ohm-meter.

**TABLE 5(a) - CONDITIONS FOR BURN-IN**

No.	CHARACTERISTICS	SYMBOL	CONDITION	UNIT
1	Ambient Temperature	$T_{amb}$	+100(+5-0) (Note 1)	$^{\circ}C$
2	Input Power	$P_{in}$	0	W

**NOTES**

1. +125(+5-0) $^{\circ}C$  for Frequency Range 'N'.

**TABLE 5(b) - CONDITIONS FOR OPERATING LIFE TESTS**

No.	CHARACTERISTICS	SYMBOL	CONDITION	UNIT
1	Ambient Temperature	$T_{amb}$	+90	$^{\circ}C$
2	Input Power DC	$P_{in}$	18 (Note 1)	W

**NOTES**

1. On each 2 ports E and SI. Power loads on SC and SD.

**FIGURE 5 - ELECTRICAL CIRCUIT FOR BURN-IN AND OPERATING LIFE TESTS**

Not applicable.

	<p style="text-align: center;">ESA/SCC Detail Specification No. 3404/001</p>	<p style="text-align: right;">PAGE 16 ISSUE 2</p>
---	--	---

4.8 ENVIRONMENTAL AND ENDURANCE TESTS (CHARTS IV AND V OF ESA/SCC GENERIC SPECIFICATION No. 3404)

4.8.1 Measurements and Inspections on Completion of Environmental Tests

The parameters to be measured and inspections to be performed on completion of environmental tests are scheduled in Table 6. Unless otherwise stated, the measurements shall be performed at  $T_{amb} = +22 \pm 3$  °C.

4.8.2 Measurements and Inspections at Intermediate Points during Endurance Tests

The parameters to be measured and inspections to be performed at intermediate points during endurance tests are scheduled in Table 6. Unless otherwise stated, the measurements shall be performed at  $T_{amb} = +22 \pm 3$  °C.

4.8.3 Measurements and Inspections on Completion of Endurance Tests

The parameters to be measured and inspections to be performed on completion of endurance testing are scheduled in Table 6. Unless otherwise stated, the measurements shall be performed at  $T_{amb} = +22 \pm 3$  °C.

4.8.4 Conditions for Operating Life Tests (Part of Endurance Testing)

The requirements for operating life testing are specified in Section 9 of ESA/SCC Generic Specification No. 3001. The conditions for operating life testing shall be as specified in Table 5(b) of this specification.

4.8.5 Electrical Circuit for Operating Life Tests (Figure 5)

Not applicable.

4.8.6 Conditions for High Temperature Storage Test (Part of Endurance Testing)

The requirements for high temperature storage test are specified in Section 9 of ESA/SCC Generic Specification No. 3404. The conditions for high temperature storage testing shall be as specified in Table 5(a) of this specification.





**TABLE 6 - MEASUREMENTS AND INSPECTIONS ON COMPLETION OF ENVIRONMENTAL TESTS AND AT INTERMEDIATE POINTS AND ON COMPLETION OF ENDURANCE TESTING**

NO.	ESA/SCC GENERIC SPEC. NO. 3404		MEASUREMENTS AND INSPECTIONS		SYMBOL	LIMITS		UNIT
	ENVIRONMENTAL AND ENDURANCE TESTS (1)	TEST METHOD AND CONDITIONS	IDENTIFICATION	CONDITIONS		MIN.	MAX.	
01	Vibration (2)	Para. 9.7	<b>During Test</b> Electrical Measurements <b>Final Measurements</b> Visual Examination	<b>Last Cycle</b> Intermittent, Open or Short Circuits <b>After Test</b> No damage	- -	- -	- -	- -
02	Shock or Bump	Para. 9.8	<b>Final Measurements</b> Visual Examination Electrical Measurements	<b>After Test</b> No damage Table 2 Items 1 to 6	- -	- Table 2	- -	- -
03	Rapid Change of Temperature	Para. 9.9	<b>Final Measurements</b> Visual Examination Electrical Measurements	<b>After 24 ± 2 hrs recovery</b> No damage Table 2 Items 1 to 6	- -	- Table 2	- -	- -
04	Climatic Sequence Dry Heat  Cold Test  Low Air Pressure	Para. 9.10 and Paras. 4.2.4 and 4.2.5 of this spec. Para. 9.10.2 Para. 9.10.4 Para. 9.10.5 Para. 9.10.7	<b>During Test</b> Electrical Measurements <b>During Test</b> Electrical Measurements <b>During Test</b> Rated Power <b>Final Measurements</b> Visual Inspection Electrical Measurements	<b>At High Temp.</b> Table 3 Item 3 <b>At Low Temp.</b> Table 3 Item 3 <b>At +35°C and 8500Pa (85mbar)</b> 40W <b>After 1 to 24 hrs recovery</b> ESA/SCC 20500 No damage Table 2 Items 1 to 6	- -	Table 3   Table 3   Table 2	- -	- -
05	Corrosion	Para. 9.11 and Para. 4.2.4 of this spec.	Not applicable	-	-	-	-	-
06	Operating Life	Para. 9.12 and Table 5(b) of this spec.	<b>Initial Measurements</b> Amplitude Balance Contact Resistance <b>Intermediate Measurements</b>  Electrical Measurements <b>Final Measurements</b>  Visual Examination Electrical Measurements	Table 2 Item 3 Table 4 Item 7 <b>At 168 and 500 hrs after 1 to 2 hrs recovery</b> Table 4 Item 7 <b>At 1000 hrs after 1 to 2 hrs recovery</b> No damage Table 2 Items 1, 2, 4, 5, 6 Table 4 Items 3 and 7	- -	Record Values Record Values   Table 4   Table 2   Table 4	- -	- -
07	RF Leakage	Para. 9.13	RF Leakage	Para. 9.13 of ESA/SCC 3404	-	Table 1(b) Item 5		dB
08	Power Level	Para. 9.14	<b>Final Measurements</b> Electrical Measurements	<b>At 1.5 × P<sub>IN</sub></b> <b>Until 15 mins after Thermal Equilibrium</b> Table 2 Items 1 to 6	-	Table 2		-

**NOTES**

- The tests in this Table refer to either Chart IV or V and shall be used as applicable.
- See Figure 2 reference vibration axis.



**TABLE 6 - MEASUREMENTS AND INSPECTIONS ON COMPLETION OF ENVIRONMENTAL TESTS AND AT INTERMEDIATE POINTS AND ON COMPLETION OF ENDURANCE TESTING (CONT'D)**

NO.	ESA/SCC GENERIC SPEC. NO. 3404		MEASUREMENTS AND INSPECTIONS		SYMBOL	LIMITS		UNIT
	ENVIRONMENTAL AND ENDURANCE TESTS (1)	TEST METHOD AND CONDITIONS	IDENTIFICATION	CONDITIONS		MIN.	MAX.	
09	High Temperature Storage	Para. 9.15 and Table 5(a) of this spec.	<b>Initial Measurements</b> Contact Resistance <b>Final Measurements</b> Visual Examination Contact Resistance Electrical Measurements	Table 4 Item 7 <b>After 1 to 2 hours recovery</b> No damage Table 4 Item 7 Table 2 Items 1 to 6	-	Record Values	-	-
10	Peak Power	Para. 9.16	<b>During Test</b>  <b>Final Measurements</b> Electrical Measurements	250W, 1.0µs pulse width at one pulse per second <b>After components reach room temp.</b> Table 2 Items 1 to 6	-	-	-	-
11	Permanence of Marking	Para. 9.17	-	-	-	-	-	-

**NOTES:** See Page 17.