



europaean space agency
agence spatiale européenne



Pages 1 to 39

**WAVEGUIDE FILTERS AND MULTIPLEXERS,
WITH WAVEGUIDE AND COAXIAL INTERFACES**

ESA/SCC Generic Specification No. 3102

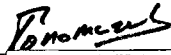
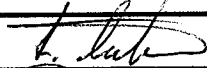
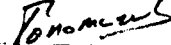
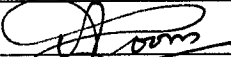

**space components
coordination group**

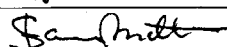
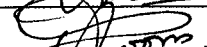
Issue/Rev.	Date	Approved by	
		SCCG Chairman	ESA Director General or his Deputy
Issue 1	November 1993		
Revision 'A'	August 1995		
Revision 'B'	August 1997		
Revision 'C'	April 1999		

**TABLE OF CONTENTS**

	<u>Page</u>
1. <u>INTRODUCTION</u>	7
1.1 Scope	7
1.2 Applicability	7
2. <u>APPLICABLE DOCUMENTS</u>	7
2.1 ESA/SCC Specifications	7
2.2 Other (Reference) Documents	8
2.3 Order of Precedence	8
3. <u>TERMS, DEFINITIONS, ABBREVIATIONS, SYMBOLS AND UNITS</u>	8
4. <u>REQUIREMENTS</u>	8
4.1 General	8
4.1.1 Specifications	8
4.1.2 Conditions and Methods of Test	8
4.1.3 Manufacturer's Responsibility for Performance of Tests and Inspections	9
4.1.4 Inspection Rights	9
4.1.5 Pre-assembly Inspection	9
4.1.6 Coaxial Connectors	9
4.2 Qualification Approval Requirements on a Manufacturer	9
4.3 Deliverable Components	9
4.3.1 Lot Failure	10
4.3.2 Testing and Lot Acceptance Levels	10
4.4 Marking	10
4.5 Materials and Finishes	10
5. <u>PRODUCTION CONTROL</u>	11
5.1 General	11
5.2 Special In-process Controls	11
5.2.1 Waveguide Flanges	11
5.2.2 Metallic Materials	11
5.2.3 Rework	11
5.2.4 Plating Thickness	11
5.2.5 Brazed Joints	11
5.2.6 Internal Solder Joints	11
5.2.7 Contact Engagement and Separation Forces	11
5.2.8 Documentation	11
6. <u>FINAL PRODUCTION TESTS</u>	13
6.1 General	13
6.2 Test Methods and Conditions	13
6.3 Failure Criteria	13
6.3.1 Parameter Limit Failure	13
6.3.2 Other Failures	13
6.4 Failed Components	13
6.5 Lot Failure	13
6.5.1 Lot Failure during 100% Testing	13
6.5.2 Lot Failure during Sample Testing	13
6.6 Documentation	14
7. <u>BURN-IN AND ELECTRICAL MEASUREMENTS</u>	14



	<u>Page</u>
8. <u>QUALIFICATION APPROVAL AND LOT ACCEPTANCE TESTS</u>	14
8.1 Qualification Testing	14
8.1.1 General	14
8.1.2 Distribution within the Qualification Test Lot	14
8.2 Lot Acceptance Testing	14
8.2.1 General	14
8.2.2 Distribution within the Sample for Lot Acceptance Testing	15
8.2.3 Lot Acceptance Level 3 Testing	15
8.2.4 Lot Acceptance Level 2 Testing	15
8.2.5 Lot Acceptance Level 1 Testing	15
8.3 Failure Criteria	15
8.3.1 General	15
8.3.2 Environmental and Mechanical Test Failures	16
8.3.3 Electrical Failures	16
8.3.4 Other Failures	16
8.4 Failed Components	16
8.5 Lot Failure	16
8.6 Documentation	16
9. <u>TEST METHODS AND PROCEDURES</u>	20
9.1 Pre-assembly Visual Inspection	20
9.2 Final Assembly	20
9.3 Weight	20
9.4 Rapid Change of Temperature	20
9.4.1 General	20
9.4.2 Final Examination	20
9.5 Vibration	20
9.5.1 General	20
9.5.2 Final Examination	21
9.6 Seal Test	21
9.7 Electrical Measurements	21
9.7.1 Electrical Test Methods	21
9.7.2 Parameter Drift Value Measurements	23
9.7.3 Electrical Measurements at High and Low Temperatures	24
9.7.4 Electrical Measurements at Room Temperature	24
9.7.5 Electrical Measurements during Endurance Testing	24
9.8 Coupling Proof Torque	24
9.9 Mating and Unmating Forces	24
9.10 Centre Contact Retention	24
9.11 RF Leakage	25
9.12 Multipaction	25
9.13 Contact Engagement and Separation Forces	29
9.14 External Visual Inspection	29
9.15 Dimension Check	29
9.16 Shock or Bump	29
9.16.1 Shock	29
9.16.2 Bump	29
9.17 Permanence of Marking	30



	<u>Page</u>
9.18 Climatic Sequence	30
9.18.1 Initial Measurements	30
9.18.2 Dry Heat	30
9.18.3 Damp Heat, Accelerated, First Cycle	30
9.18.4 Cold Test	30
9.18.5 Low Air Pressure	30
9.18.6 Damp Heat, Accelerated, Remaining Cycles	31
9.18.7 Final Measurements	31
9.19 Corrosion	31
9.20 Operating Life	31
9.20.1 Initial Measurements	31
9.20.2 Mounting	31
9.20.3 Procedure	31
9.20.4 Final Measurements	32
9.21 Peak Power	32
9.22 Power Level	32
9.23 High Temperature Storage	32
9.23.1 Initial Measurements	32
9.23.2 Procedure	32
9.23.3 Final Measurements	32
9.24 Endurance	32
10. <u>DATA DOCUMENTATION</u>	33
10.1 General	33
10.1.1 Qualification Approval	33
10.1.2 Testing Level 'B'	33
10.1.3 Testing Level 'C'	33
10.1.4 Data Retention/Data Access	33A
10.2 Cover Sheet(s)	33A
10.3 List of Equipment Used	34
10.4 List of Test References	34
10.5 Special In-process Control Data	34
10.6 Final Production Test Data	34
10.6.1 Test Result Summary	34
10.6.2 Testing Level 'B'	35
10.7 Burn-in and Electrical Measurement Data	35
10.8 Qualification Test Data	35
10.9 Lot Acceptance Test Data	35
10.9.1 Testing Level 'B'	35
10.9.2 Testing Level 'C'	35
10.10 Failed Component List and Failure Analysis Report	35
10.11 Certificate of Conformity	36
11. <u>DELIVERY</u>	36
12. <u>PACKAGING AND DESPATCH</u>	36
<u>CHARTS</u>	
I TESTING LEVELS	12
II FINAL PRODUCTION TESTS	17
III BURN-IN AND ELECTRICAL MEASUREMENTS	17
IV QUALIFICATION TESTS	18
V LOT ACCEPTANCE TESTS	19

**SCC**ESA/SCC Generic Specification
No. 3102

PAGE 6

ISSUE 1

FIGURES

	<u>Page</u>	
I	INSERTION LOSS, ISOLATION, AND OUT-OF-BAND REJECTION TEST SET-UP	22
II	GROUP DELAY TEST SET-UP	22
III	RETURN LOSS TEST SET-UP	23
IV	R.F. LEAKAGE TEST SET-UP	25
V	MULTIPACTION SUSCEPTIBILITY ZONES	28

ANNEXES

I	LTPD SAMPLING PLAN FOR LOT SIZES GREATER THAN 200 DEVICES	37
	LTPD SAMPLING PLAN FOR LOT SIZES LESS THAN OR EQUAL TO 200 DEVICES	38

**1. INTRODUCTION****1.1 SCOPE**

This specification defines the general requirements for the qualification approval, procurement, including lot acceptance testing, and delivery of Waveguide Filters and Multiplexers, with Waveguide and Coaxial Interfaces, suitable for space application.

This specification contains the appropriate inspection and test schedules and also specifies the data documentation requirements.

1.2 APPLICABILITY

This specification is primarily applicable to the granting of qualification approval to a component in accordance with ESA/SCC Basic Specification No. 20100 and the procurement of such components from qualified Manufacturers.

2. APPLICABLE DOCUMENTS

The following documents form part of, and shall be read in conjunction with, this specification. The relevant issues shall be those in effect at the date of placing the purchase order.

2.1 ESA/SCC SPECIFICATIONS

No. 20100, Requirements for the Qualification of Standard Electronic Components for Space Application.

No. 20400, Internal Visual Inspection.

No. 20500, External Visual Inspection.

No. 20600, Preservation, Packaging and Despatch of SCC Electronic Components.

No. 21300, Terms, Definitions, Abbreviations, Symbols and Units.

No. 21700, General Requirements for the Marking of SCC Components.

No. 22800, ESA/SCC Non-conformance Control System.

No. 23500, Requirements for Lead Materials and Finishes for Components for Space Application.

No. 24600, Minimum Quality System Requirements.

No. 24800, Resistance to Solvents of Marking, Materials and Finishes.



No. 3402, Connectors, RF, Coaxial.

No. 3402/xxx, Detail Specifications for Connectors, RF, Coaxial.

With the exception of ESA/SCC Basic Specification Nos. 20100, 21700, 22800 and 24600, where Manufacturers' specifications are equivalent to, or more stringent than, the ESA/SCC Basic Specifications listed above, they may be used in place of the latter, subject to the approval of the appropriate Qualifying Space Agency.

Such replacements will be clearly identified in the applicable Process Identification Document (P.I.D.) and listed in an appendix to the appropriate Detail Specification.

Unless otherwise stated herein, references within the text of this specification to "the Detail Specification" shall mean the relevant ESA/SCC Detail Specification.

 	<p style="text-align: center;">ESA/SCC Generic Specification No. 3102</p>	<p style="text-align: center;">Rev. 'B'</p>	<p>PAGE 8 ISSUE 1</p>
---	---	---	---------------------------

2.2 OTHER (REFERENCE) DOCUMENTS

ESA PSS-01-201, Contamination and Cleanliness Control.

ESA PSS-01-301, Derating Requirements and Application Rules for Electronic Components.

ESA PSS-01-702, A Thermal Vacuum Test for the Screening of Space Materials.

ESA PSS-01-708, The Manual Soldering of High Reliability Electrical Connections.

ESA PSS-01-737, Determination of the Susceptibility of Metals to Stress Corrosion and Cracking.

IEC Publication No. 68, Basic Environmental Testing Procedures.

IEC Publication No. 154, Flanges for Waveguides.

IEC Publication No. 410, Sampling Plans and Procedures for Inspection by Attributes or,

MIL-STD-105, Sampling Procedures and Tables for Inspection by Attributes.

MIL-F-3922, Flange, Waveguide, General Purpose, General Specification for.

2.3 ORDER OF PRECEDENCE

For the purpose of interpretation and in case of conflict with regard to documentation, the following order of precedence shall apply:-

- (a) ESA/SCC Detail Specification.
- (b) ESA/SCC Generic Specification.
- (c) ESA/SCC Basic Specification.
- (d) Other documents, if referenced herein.

3. TERMS, DEFINITIONS, ABBREVIATIONS, SYMBOLS AND UNITS

The terms, definitions, abbreviations, symbols and units specified in ESA/SCC Basic Specification No. 21300 shall apply.

4. REQUIREMENTS

4.1 GENERAL

The test requirements for qualification approval of a component shall comprise final production tests (see Chart II) and qualification testing (see Chart IV)

The test requirements for procurement of components shall comprise final production tests (Chart II) together with, when applicable, a level of lot acceptance testing (see Chart V) to be specified by the Orderer.

If a Manufacturer elects to eliminate a final production test by substituting an in-process control or statistical process control procedure, the Manufacturer is still responsible for delivering components that meet all of the performance, quality and reliability requirements defined in this specification and the Detail Specification.

4.1.1 Specifications

For qualification approval, procurement (including lot acceptance testing) and delivery of components in conformity with this specification, the specifications listed in Section 2 of this document shall apply in total unless otherwise specified herein or in the Detail Specification.

4.1.2 Conditions and Methods of Test

The conditions and methods of test shall be in accordance with this specification, the ESA/SCC Basic Specifications referenced herein and the Detail Specification.



4.1.3 Manufacturer's Responsibility for Performance of Tests and Inspections

The manufacturer shall be responsible for the performance of tests and inspections required by the applicable specifications. These tests and inspections shall be performed at the plant of the Manufacturer of the components unless it is agreed by the Qualifying Space Agency, prior to commencing qualification testing, or procurement, to use an approved external facility.

4.1.4 Inspection Rights

The Qualifying Space Agency (for qualification approval or for a procurement) reserves the right to monitor any of the tests and inspections scheduled in the applicable specifications.

4.1.5 Pre-assembly Inspection

The Manufacturer shall notify the Orderer at least 2 working weeks before the commencement of the final assembly stage.

The Orderer shall indicate immediately whether or not he intends to witness the inspection.

4.1.6 Coaxial Connectors

4.1.6.1 Non-Integral Coaxial Connectors

All non-integral connectors shall be ESA/SCC qualified.

4.1.6.2 Integral Coaxial Connectors

Integral coaxial connectors shall only be used when the equivalent non-integral coaxial connector type (including the mating male or female connector and connector saver) is ESA/SCC qualified.

Integral connectors shall meet all of the interface, material and performance requirements for the equivalent non-integral ESA/SCC qualified coaxial connector.

4.2 QUALIFICATION APPROVAL REQUIREMENTS ON A MANUFACTURER



To obtain and maintain the qualification approval of a component, or family of components, a Manufacturer shall satisfy the requirements of ESA/SCC Basic Specification No. 20100.

4.3 DELIVERABLE COMPONENTS

Components delivered to this specification shall be processed and inspected in accordance with the relevant Process Identification Document (P.I.D.).

ESA/SCC qualified components delivered to this specification shall be produced from lots that are capable of passing all tests, and sequences of tests, that are defined in Charts IV and V. The Manufacturer shall not knowingly supply components that cannot meet this requirement. In the event that, subsequent to delivery and prior to operational use, a component is found to be in a condition such that it could not have passed these tests at the time of manufacture, this shall be grounds for rejection of the delivered lot.

Each delivered component shall be traceable to its production lot. Components delivered to this specification shall have completed satisfactorily all tests to the testing level and lot acceptance level specified in the purchase order (see Para. 4.3.2).

		<p style="text-align: center;">ESA/SCC Generic Specification No. 3102</p>	<p style="text-align: center;">Rev. 'A'</p>	<p>PAGE 10 ISSUE 1</p>
--	--	---	---	----------------------------

4.3.1 Lot Failure

Lot failure may occur during final production tests (Chart II), qualification testing (Chart IV) or lot acceptance testing (Chart V).

Should such failure occur, the non-conformance procedure shall be initiated in accordance with ESA/SCC Basic Specification No. 22800.

Should such failure occur during procurement, the Manufacturer shall notify the Orderer by telex within 2 working days, giving details of the number and mode of failure and the suspected cause.

In the case where qualification approval has been granted to the component, he shall, at the same time by the same means, inform the Qualifying Space Agency in order that the latter may consider its implications. No further testing shall be performed on the failed components except on instructions from the Orderer. The Orderer shall inform the Manufacturer and the Qualifying Space Agency within 2 working days of receipt of the telex, by the same means what action shall be taken.

In the case where lot failure occurs during qualification testing, the Manufacturer shall immediately notify the appropriate Qualifying Space Agency who will define a course of action to be followed. No further testing shall be performed on the failed components.

4.3.2 Testing and Lot Acceptance Levels

This specification defines 1 level of testing severity which is designated by the letter 'B' (see Chart I) and 3 levels of lot acceptance testing (see Chart V).

The Lot Acceptance levels are designated 1, 2 and 3 and are comprised of tests as follows:-

Level 3 (LA3) - Electrical Subgroup.

Level 2 (LA2) - Endurance Subgroup
plus Electrical Subgroup.

Level 1 (LA1) - Environmental and Mechanical Subgroup
plus Endurance Subgroup
plus Electrical Subgroup.

The required testing level and lot acceptance level shall both be specified in a purchase order.

4.4 MARKING

All components procured and delivered to this specification from a source qualified according to ESA/SCC Basic Specification No. 20100 shall be marked in accordance with ESA/SCC Basic Specification No. 21700. Thus, they shall bear the ESA symbol to signify their conformance to the ESA/SCC qualification approval requirements and full compliance with the requirements of this specification and the Detail Specification.

Component procured from sources which are not ESA/SCC qualified, provided that they fully comply with the procurement requirements of this specification and the Detail Specification, may bear the SCC marking **with the exception of the ESA symbol.**

4.5 MATERIALS AND FINISHES

All non-metallic materials and finishes, that are not within a hermetically sealed enclosure, of the components specified herein shall meet the outgassing requirements as outlined in ESA PSS-01-702.

Specific requirements for materials and finishes are specified in the Detail Specification.

	<p style="text-align: center;">ESA/SCC Generic Specification No. 3102</p>	<p style="text-align: right;">PAGE 11 ISSUE 1</p>
--	---	---

5. PRODUCTION CONTROL

5.1 GENERAL

The minimum requirements for production control, which are equally applicable to procurement, are defined in the Process Identification Document (P.I.D.).

5.2 SPECIAL IN-PROCESS CONTROLS

5.2.1 Waveguide Flanges

Waveguide flanges should meet the requirements of IEC Publication No.154 or MIL-F-3922, as applicable.

5.2.2 Metallic Materials

Metallic materials shall, prior to the commencement of qualification testing and before any metallic material changes to a qualified device are approved by the Qualifying Space Agency, be verified that they meet Class 1 or 2 of the stress corrosion requirements of ESA PSS-01-737.

5.2.3 Rework

Any rework procedures must be agreed with the appropriate Qualifying Space Agency and form part of the P.I.D.

5.2.4 Plating Thickness

The thickness of the plating shall be measured by microsectioning or a non-destructive method. In the case of conflict the microsectioning method shall prevail. The form of the sample shall be agreed with the appropriate Qualifying Space Agency and form part of the P.I.D.

5.2.5 Brazed Joints

A representative sample of a brazed joint shall be microsectioned in order to check the consistency, etc. of the braze. The form of the sample shall be agreed with the appropriate Qualifying Space Agency and form part of the P.I.D.

5.2.6 Internal Solder Joints

All internal solder joints shall be made/inspected, as closely as practicably, in accordance with the requirements of ESA PSS-01-708.

5.2.7 Contact Engagement and Separation Forces

(a) Applicability

This test is applicable only to devices with integral coaxial connectors.

(b) Procedure

The test shall be performed in accordance with ESA/SCC Generic Specification No. 3402, Para. 5.2.1. References to the Detail Specification shall mean the ESA/SCC Detail Specification No. 3402/xxx that would define the coaxial connector if it was non-integral.

5.2.8 Documentation

Documentation of special in-process controls shall be in accordance with the requirements of Para. 10.5 of this specification.

CHART I - TESTING LEVELS

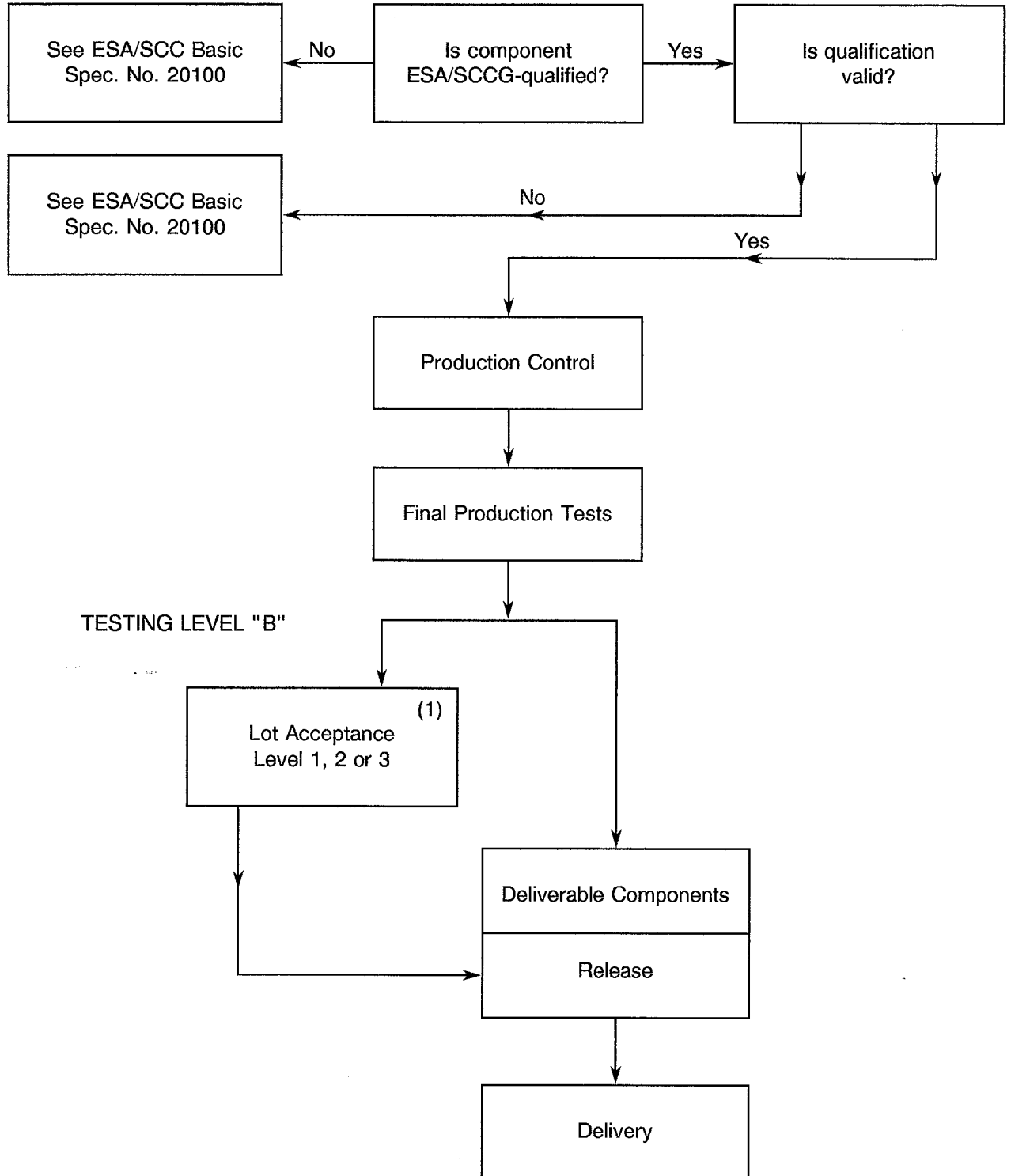

NOTES

1. When applicable.

**6. FINAL PRODUCTION TESTS****6.1 GENERAL**

Unless otherwise specified in the Detail Specification, all components used for qualification testing and all components for delivery, including those submitted to lot acceptance tests, shall be subjected to tests and inspections in accordance with Chart II.

Unless otherwise specified in the Detail Specification, the tests shall be performed in the order shown.

Any components that do not meet these requirements shall be removed from the lot and at no future time be re-submitted to the requirements of this specification.

6.2 TEST METHODS AND CONDITIONS

The applicable test methods and conditions are specified in the paragraphs referenced in Chart II of this specification.

6.3 FAILURE CRITERIA**6.3.1 Parameter Limit Failure**

A component shall be counted as a limit failure if one or more parameters exceed the limits shown in Tables 2 or 3 of the Detail Specification.

6.3.2 Other Failures

A component shall be counted as a failure in any of the following cases:

- Mechanical failure.
- Handling failure.
- Lost component.

6.4 FAILED COMPONENTS

A component shall be considered as a failed component if it exhibits one or more of the failure modes described in Para. 6.3 of this specification.

6.5 LOT FAILURE

In the case of lot failure, the Manufacturer shall act in accordance with the requirements of Para. 4.3.1 of this specification. Pre-assembly visual inspection rejects shall not be counted when determining lot failure.

6.5.1 Lot Failure During 100% Testing

If the number of components failed on the basis of the failure criteria defined in Para. 6.3 exceeds 10% (rounded upwards to the nearest whole number) of the number of components submitted to the test, the lot shall be considered as failed.

A lot is composed of groups of components of the same technology as defined in the Detail Specification manufactured under the same conditions and at the same time.

6.5.2 Lot Failure During Sample Testing

A lot shall be considered as failed if the number of allowable failures during sample testing, in accordance with General Inspection Level II of IEC Publication No. 410 or MIL-STD-105 and the applicable AQL as specified in the Detail Specification, is exceeded.

	<p style="text-align: center;">ESA/SCC Generic Specification No. 3102</p>	<p style="text-align: center;">Rev. 'C'</p>	<p>PAGE 14 ISSUE 1</p>
---	---	---	----------------------------

In the case where an LTPD is specified in the Detail Specification, a lot shall be considered as failed if the number of failures allowed is exceeded (see Annexe I for LTPD Sampling Plan).

If lot failure occurs in either case, 100% testing may be performed with the lot failure criteria given in Para. 6.5.1.

6.6 DOCUMENTATION

Documentation of final production test data shall be in accordance with the requirements of Para. 10.6 of this specification.

7. BURN-IN AND ELECTRICAL MEASUREMENTS

Not applicable.

8. QUALIFICATION APPROVAL AND LOT ACCEPTANCE TESTS

8.1 QUALIFICATION TESTING

8.1.1 General

Qualification testing shall be in accordance with the requirements of Chart IV of this specification. The tests to Chart IV shall be performed on the specified sample, chosen at random from components which have successfully passed the tests in Chart II for testing level 'B'. This sample constitutes the qualification test lot.

The qualification test lot is divided into subgroups of tests and all components assigned to a subgroup shall be subjected to all of the tests in that subgroup, in the sequence shown.

The applicable test requirements are detailed in the paragraphs referenced in Chart IV.

The conditions governing qualification testing are given in ESA/SCC Basic Specification No. 20100, Para. 5:3 and, for the extension or renewal of a qualification approval, in Paras. 6.3 and 6.4.

8.1.2 Distribution within the Qualification Test Lot

Where a Detail Specification covers a range, or series of components that are considered similar, then the qualification test lot shall be comprised of component types, so selected that they adequately represent all of the various mechanical, structural and electrical peculiarities of that range or series.

The selected distribution shall be as specified by, or agreed with, the Qualifying Space Agency.

If more than 1 component type is needed to adequately cover the range of components under qualification, the increase in sample size in Chart IV and the sample distribution within the subgroups shall be as specified by, or agreed with, the Qualifying Space Agency.

8.2 LOT ACCEPTANCE TESTING



8.2.1 General

The sample sizes of the 3 lot acceptance levels are specified in Chart V. All components assigned to a subgroup shall be subjected to all of the tests of that subgroup in the sequence shown.

The tests to Chart V shall be performed on the specified sample which shall have been chosen, whenever possible, at random from the proposed delivery lot (but see Para. 8.2.3(b)).

The applicable test requirements are detailed in the paragraphs referenced in Chart V.

As a minimum for procurement of non-qualified components, lot acceptance level 3 tests shall apply. For procurement of qualified components, lot acceptance testing shall be performed if specified in a purchase order. Procurement lots ordered with a lot acceptance test level shall be delivered only after successful completion of lot acceptance testing.

 	<p style="text-align: center;">ESA/SCC Generic Specification No. 3102</p>	<p style="text-align: center;">Rev. 'B'</p>	<p>PAGE 15 ISSUE 1</p>
---	---	---	----------------------------

8.2.2 Distribution within the Sample for Lot Acceptance Testing

Where a Detail Specification covers a range, or series, of components that are considered similar, then it may be necessary that the sample for lot acceptance testing be comprised of component types so selected that they adequately represent all of the various mechanical, structural and electrical peculiarities of that range or series.

The distribution of the component types will normally vary from procurement to procurement and shall be as specified by the Orderer, following as closely as possible the requirements prescribed in Para. 8.1.2 of this specification.

8.2.3 Lot Acceptance Level 3 Testing (LA3)

Lot acceptance level 3 tests are designated as the electrical subgroup and comprise electrical measurements of characteristics and tests to prove the assembly capability of the component.

For LA3 testing, the following requirements and conditions shall apply:-

- (a) LA3 testing shall be performed by the Manufacturer's quality assurance personnel using dedicated quality assurance equipment whenever possible. LA3 testing shall not be a repetition of routine measurements made by production personnel during final production tests.
- (b) When tests to Tables 2 and 3 of the Detail Specification have been performed on a sample basis, then the components for LA3 testing shall be selected from this sample.
- (c) The electrical measurements for LA3 are considered to be non-destructive and therefore components so tested may form part of the delivery lot.
- (d) When required in the purchase order, the Manufacturer shall notify the Orderer at least 2 working weeks before the commencement of LA3 testing. The Orderer shall indicate immediately whether or not he intends to witness the tests.

8.2.4 Lot Acceptance Level 2 Testing (LA2)

Lot acceptance level 2 testing shall comprise the tests for LA3 (electrical subgroup) plus tests on an endurance subgroup. For the electrical subgroup, the requirements and conditions as for LA3 (see Para. 8.2.3) shall apply.

For the endurance subgroup, the following shall apply:-

- (a) The tests in this subgroup are considered to be destructive and therefore components so tested shall not form part of the delivery lot.

8.2.5 Lot Acceptance Level 1 Testing (LA1)

Lot acceptance level 1 testing shall comprise the tests for LA2 (endurance subgroup) and LA3 (electrical subgroup) plus tests on an environmental and mechanical subgroup. For the electrical and endurance subgroups, the requirements and conditions for LA3 (see Para. 8.2.3) and LA2 (see Para. 8.2.4) respectively shall apply.



For the environmental and mechanical subgroup, the following shall apply:-

- (a) The tests in this subgroup are considered to be destructive and therefore components so tested shall not form part of the delivery lot.

8.3 FAILURE CRITERIA

8.3.1 General

The following criteria shall apply to qualification testing and to lot acceptance testing.

 	<p style="text-align: center;">ESA/SCC Generic Specification No. 3102</p>	<p style="text-align: center;">Rev. 'B'</p>	<p>PAGE 16 ISSUE 1</p>
---	---	---	----------------------------

8.3.2 Environmental and Mechanical Test Failures

The following shall be counted as component failures:

- Components which fail during tests for which the pass/fail criteria are inherent in the test method, e.g. seal.

8.3.3 Electrical Failures

The following shall be counted as component failures:-

- (a) Components which, when subjected to electrical measurement on completion of environmental tests, in accordance with either Table 2 or Table 6, as specified in the Detail Specification, fail one or more of the applicable limits.
- (b) Components which, when subjected to electrical measurements at intermediate and end points during endurance testing, in accordance with Table 6 of the Detail Specification, fail one or more of the applicable limits.
- (c) Components which, when subjected to measurement of electrical characteristics, in accordance with Tables 2 and 3 of the Detail Specification, fail one or more of the applicable limits.

8.3.4 Other Failures

The following additional failures may also occur during qualification testing or lot acceptance testing:-

- (a) Component failing to comply with the requirements of ESA/SCC Basic Specification No. 20500.
- (b) Lost components.

8.4 FAILED COMPONENTS

A component shall be considered as failed if it exhibits one or more of the failure modes detailed in Para. 8.3 of this specification.

The allowable number of failed components per subgroup, the aggregate failure constraints and the permitted distribution of such failures are shown at the foot of Charts IV and V of this specification.

When requested by the Qualifying Space Agency or the Orderer, failure analysis of failed components shall be performed by the Manufacturer and the results provided.

Failed components from successful lots shall be marked as such and be stored at the Manufacturer's plant for 24 months.

8.5 LOT FAILURE

A lot shall be considered as failed if the allowable number of failures according to Chart IV or V of this specification, as relevant, has been exceeded.

In the case of lot failure, the Manufacturer shall act in accordance with Para. 4.3.1 of this specification.

8.6 DOCUMENTATION

For qualification testing, the qualification test data shall be documented in accordance with the requirements of Para. 10.8 of this specification.

In the case of lot acceptance testing, the data shall be documented in accordance with the requirements of Para. 10.9 of this specification.



CHART II- FINAL PRODUCTION TESTS

Production Control in accordance with
Section 5 of this Specification

Para. 9.1	Pre-assembly Visual Inspection	(1)
Para. 9.2	Final Assembly	
Para. 4.4	Marking (plus Serialisation)	
Para. 9.7.1.8	Voltage Proof	
Para. 9.3	Weight	
Para. 9.4	Rapid Change of Temperature	
Para. 9.5	Vibration	
Para. 9.6	Seal Test	(1)
Para. 9.7.4	Electrical Measurements at Room Temperature	
Para. 9.8	Coupling Proof Torque, Level S-4, AQL 1.0	
Para. 9.9	Mating and Unmating Forces	
Para. 9.10	Centre Contact Retention	
Para. 9.11	RF Leakage	
Para. 9.12	Multipaction	
Para. 9.7.3	Electrical Measurements at High and Low Temperatures	
Para. 9.13	Contact Engagement and Separation Forces	
Para. 9.14	External Visual Inspection	
Para. 9.15	Dimension Check	
Para. 6.5	Check for Lot Failure	

To Chart IV or V

NOTES

1. Pre-assembly visual inspection and seal test rejects not to be counted for lot failure.

CHART III - BURN-IN AND ELECTRICAL MEASUREMENTS

Not applicable.



CHART IV - QUALIFICATION TESTS

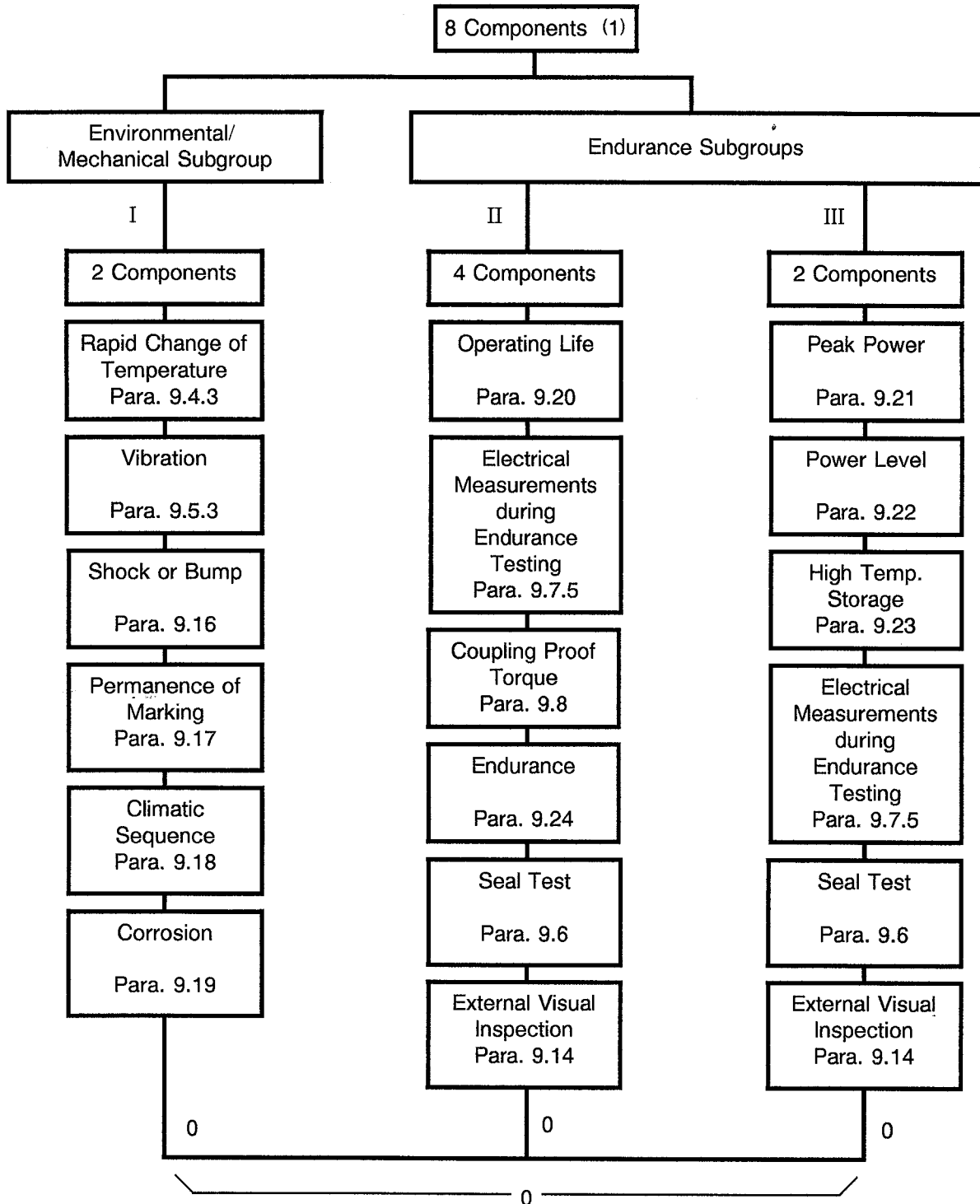

Total allowable number of failed components: 0.

NOTES

1. For distribution within the subgroups, see Para. 8.1.2.



CHART V - LOT ACCEPTANCE TESTS

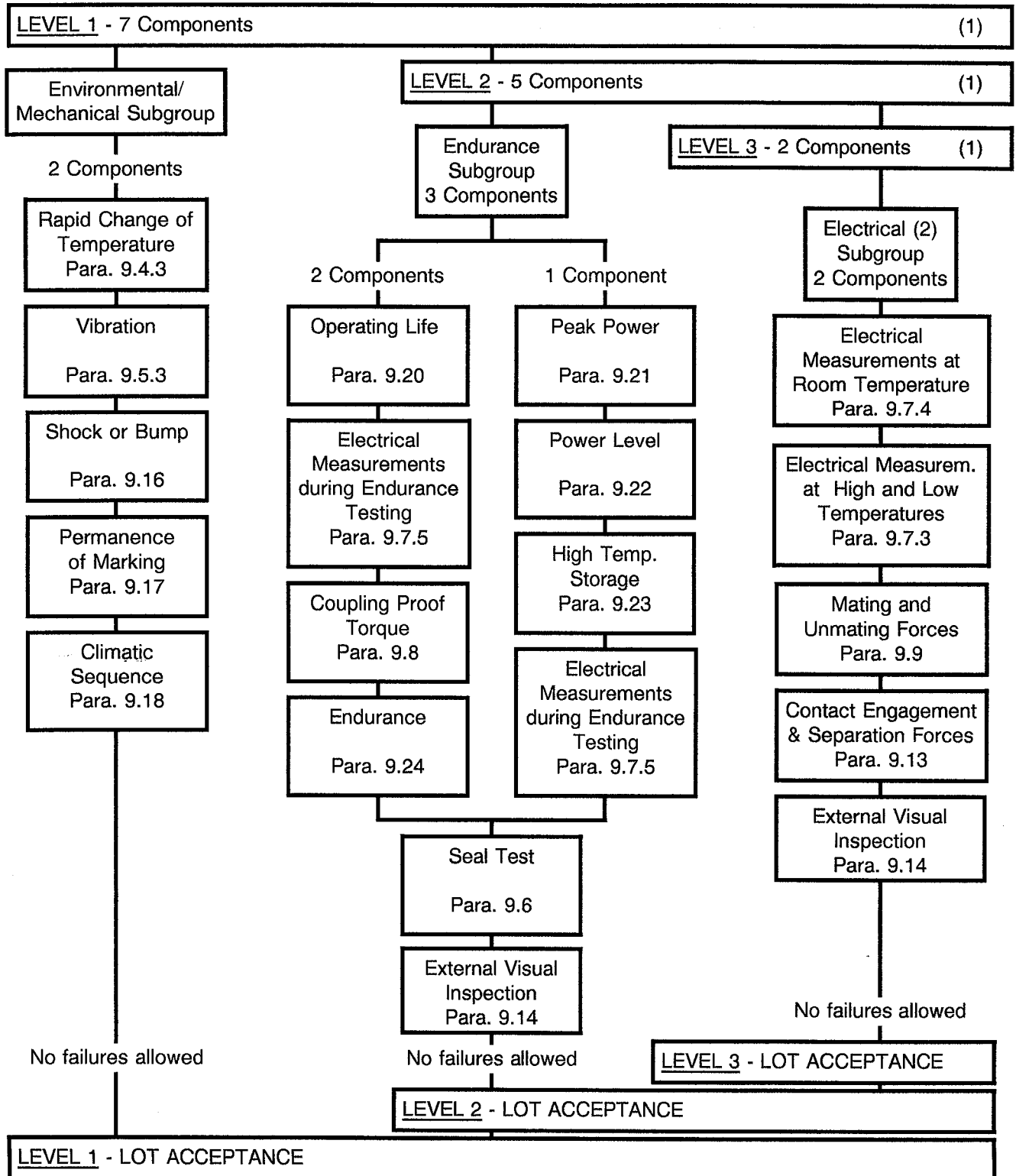

NOTES

1. For distribution within the sample, see Para. 8.2.2.
2. The tests in this subgroup are considered to be non-destructive and therefore components so tested shall form part of the delivery lot.

	<p style="text-align: center;">ESA/SCC Generic Specification No. 3102</p>	<p style="text-align: center;">Rev. 'B'</p>	<p style="text-align: right;">PAGE 20 ISSUE 1</p>
--	---	---	---

9. TEST METHODS AND PROCEDURES

If a Manufacturer elects to eliminate or modify a test method or procedure, the Manufacturer is still responsible for delivering components that meet all of the performance, quality and reliability requirements defined in this specification and the Detail Specification.

Documentation supporting the change shall be approved by the Qualifying Space Agency and retained by the Manufacturer. It shall be copied, when requested, to the Qualifying Space Agency.

The change shall be specified in the Detail Specification and in the P.I.D.

9.1 PRE-ASSEMBLY VISUAL INSPECTION

In accordance with ESA/SCC Basic Specification Nos. 20400 and 20500, as applicable.

9.2 FINAL ASSEMBLY

In accordance with the Process Identification Document (P.I.D.).

9.3 WEIGHT

The weight of the component shall not exceed that given in the Detail Specification.

9.4 RAPID CHANGE OF TEMPERATURE

9.4.1 General

The components shall be subjected to Test 'Na' of IEC Publication No. 68-2-14 .

During Chart II

The number of cycles shall be 5 with 30 minutes at each operating temperature extreme as specified in the Detail Specification.

During Charts IV or V

The number of cycles shall be 10 with 30 minutes at each storage temperature extreme as specified in the Detail Specification. After a recovery period of 24 ± 2 hours at room temperature, electrical measurements as specified in Table 6 of the Detail Specification shall be performed and shall not exceed the specified limits.

9.4.2 Final Examination

The components shall be examined for evidence of damage or loosening of parts.

9.5 VIBRATION

9.5.1 General

The specimens shall be fixed to the vibration machine, either directly or by means of a fixture as specified below. Mounting fixtures shall enable the specimens to be subjected to vibration along the 3 mutually perpendicular axes in turn. When the component is provided with specified mounting means, these shall be used as specified in the Detail Specification and any additional restraining straps should be avoided.

Unless otherwise specified in the Detail Specification, components not provided with specific mounting means shall be clamped by the body. When external connections, necessary for measuring and supply purposes are specified in the Detail Specification, they should add the minimum restraint and weight.

The components shall be subjected to Test 'Fc' of IEC Publication No. 68-2-6, sweep frequency 10-2000-10Hz. The entire frequency range of 10 to 2000Hz and return to 10Hz shall be traversed in 10 minutes. This constitutes 1 cycle. The vibration amplitude shall be 1.5mm from 10Hz to the higher cross-over frequency and then 20g acceleration to 2000Hz.

During Chart II

The number of cycles shall be 3 along each of the 3 axes specified in the Detail Specification (i.e. 9 times in total), so that the motion is applied for a total period of approximately 90 minutes.

During Charts IV or V

The number of cycles shall be 12 along each of the 3 axes specified in the Detail Specification (i.e. 36 times in total), so that the motion is applied for a total period of approximately 6 hours. After vibration, electrical measurements as specified in Table 6 of the Detail Specification shall be performed and shall not exceed the specified limits.

9.5.2 Final Examination

The components shall be examined for evidence of damage or loosening of parts.

9.6 SEAL TEST

Either of the following tests shall be performed:-

- (a) The components shall be subjected to Test 'Qk' of IEC Publication No. 68-2-17, Method 1, Severity 1000h. Prior to the test the units shall be carefully cleaned. Unless otherwise specified in the Detail Specification, immersion pressure shall not exceed 4 bars. After pressurisation, the specimens shall be externally cleaned and subjected to leakage measurements within a maximum of 1 hour, but not less than half an hour, of removal from the pressure chamber.
- (b) The component shall be equipped with air pressure test flanges and gaskets on one side and a cover flange and gasket on the opposite side. The air pressure shall be adjusted to 105kPa. The component shall be disconnected from the test set and immersed in water at an ambient temperature of $+25 \pm 2$ °C for 1 minute. No bubbles shall be observed from the component or flange areas.

9.7 ELECTRICAL MEASUREMENTS9.7.1 Electrical Test Methods

9.7.1.1 General

All equipment shall have the same characteristic impedance. For deliverable connectorised devices, ESA/SCC qualified connector savers shall be used for the performance of electrical tests. The effect of these on the measurements shall be taken into consideration. The ends of connector savers that mate with deliverable devices shall only be mated/unmated for the maximum number of cycles specified in ESA PSS-01-301. Where a parameter is specified over a frequency range a plot of that parameter, over the specified swept frequency range, shall be produced.

N.B.

During measurements, unused ports shall be terminated with matched loads.

9.7.1.2 Insertion Loss

The insertion loss, for all lines of the device, over the entire operating frequency range(s) (as defined in the Detail Specification) of each one of the devices shall be measured using the test set-up in Figure I. Using the same equipment, any insertion loss variation requirement may also be measured.

9.7.1.3 Isolation

(a) **General**

The isolation, over the entire operating frequency range(s) (as defined in the Detail Specification) shall be measured using the test set-up in Figure I.



(b) **Multiplexers**

The isolation shall be measured between non-common (channel) ports, over the frequency range(s) defined in the Detail Specification.

9.7.1.4 **Out-of-Band Rejection**

The out-of-band rejection, for all lines of the device, over the frequency range(s) defined in the Detail Specification shall be measured using the test set-up in Figure I.

FIGURE I - INSERTION LOSS, ISOLATION AND OUT-OF-BAND REJECTION TEST SET-UP

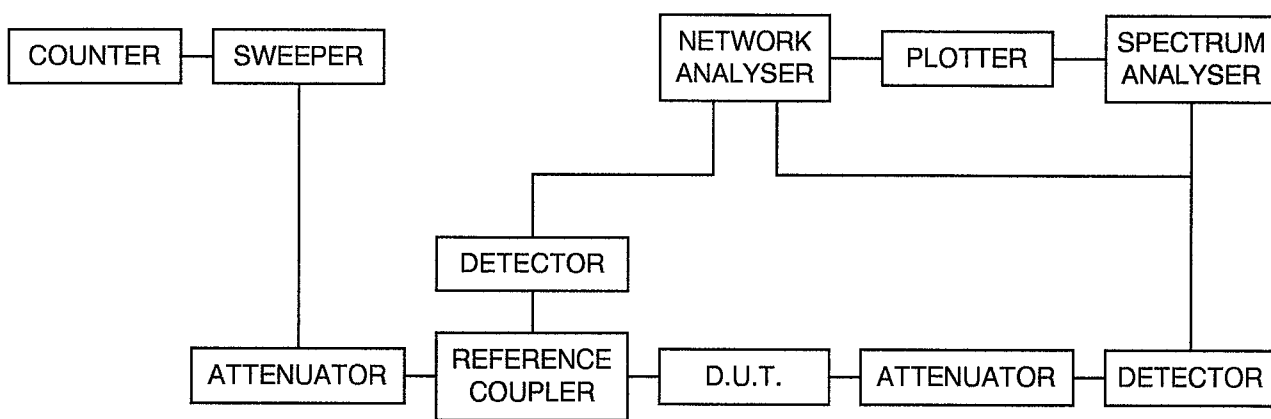

9.7.1.5 **Group Delay**

The group delay, for all lines of the device, over the entire operating frequency range(s) (as defined in the Detail Specification) of each one of the devices shall be measured using the test set-up in Figure II.

FIGURE II - GROUP DELAY TEST SET-UP

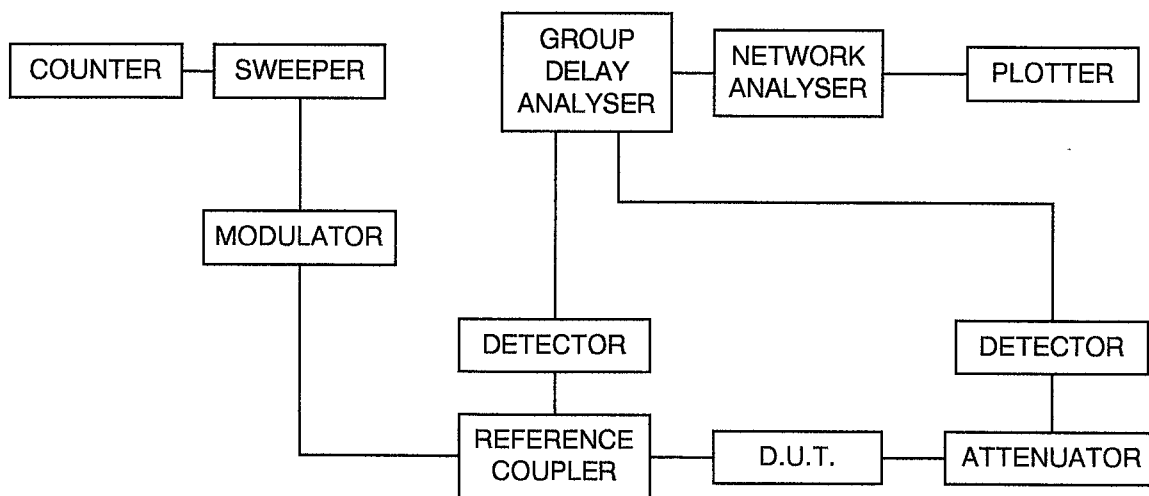

9.7.1.6 Return Loss

The return loss, over the entire operating frequency range(s) (as defined in the Detail Specification) shall be measured using the test set-up in Figure III. All output ports shall be terminated with matched loads.

FIGURE III - RETURN LOSS TEST SET-UP

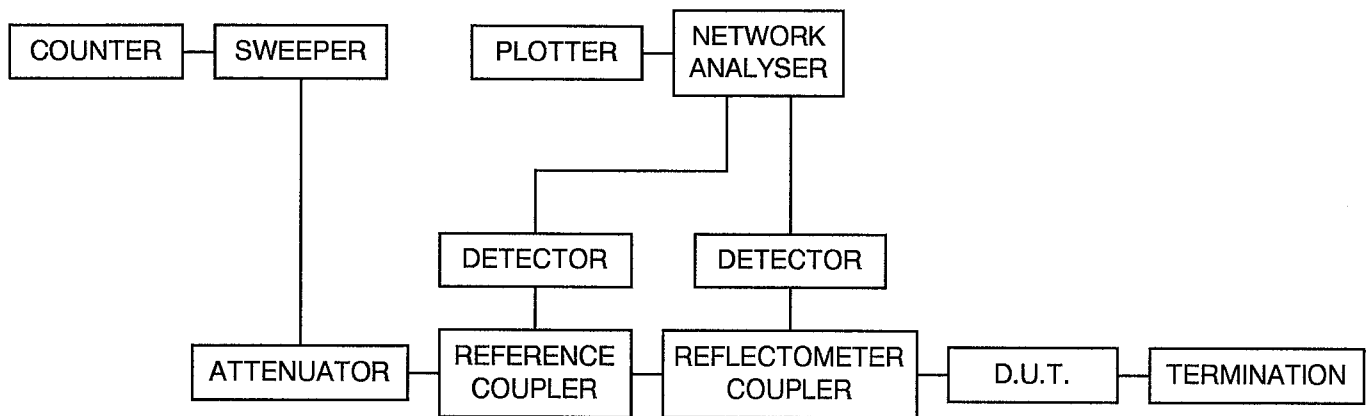

9.7.1.7 Insulation Resistance

(a) **Applicability**

This measurement is applicable only to devices with integral coaxial connectors.

(b) **Procedure**

The insulation resistance shall be measured between the centre contact and the housing in accordance with Test '3a', Method A of IEC Publication No. 512-2, using a voltage of 500 ± 50 V.

The value obtained shall not be less than that defined in the Detail Specification.

9.7.1.8 Voltage Proof

(a) **Applicability**

This measurement is applicable only to devices with integral coaxial connectors.

(b) **Procedure**

The test shall be performed in accordance with ESA/SCC Generic Specification No. 3402, Para. 9.2. The test voltage shall be as defined in the ESA/SCC 3402/xxx Detail Specification that would define the coaxial connector if it was non-integral.

9.7.2 Parameter Drift Value Measurements

Not applicable.

	<p style="text-align: center;">ESA/SCC Generic Specification No. 3102</p>	<p style="text-align: right;">PAGE 24 ISSUE 1</p>
---	---	---

9.7.3 Electrical Measurements at High and Low Temperatures

For components of testing level 'B', the electrical measurements at high and low temperatures shall be made in accordance with Table 3 of the Detail Specification. Where sample testing is applied, note the requirements of Para. 8.2.3(b). For testing level 'B', all values shall be recorded against serial numbers.

9.7.4 Electrical Measurements at Room Temperature

For components of testing level 'B', the measurements of electrical characteristics shall be made in accordance with Table 2 of the Detail Specification. Where sample testing is applied, note the requirements of Para. 8.2.3(b). For testing level 'B', all values shall be recorded against serial numbers.

9.7.5 Electrical Measurements during Endurance Testing

At each of the relevant data points specified for endurance testing, measurements shall be made of all parameters listed in Table 6 of the Detail Specification. All values obtained shall be recorded against serial numbers and the parameter drift calculated, if required.

9.8 COUPLING PROOF TORQUE

(a) **Applicability**

This test is applicable only to devices with integral coaxial connectors.

(b) **Procedure**

The test shall be performed in accordance with ESA/SCC Generic Specification No. 3402, Para. 9.4. References to the 'Detail Specification' shall mean the ESA/SCC 3402/xxx Detail Specification that would define the coaxial connector if it was non-integral.

9.9 MATING AND UNMATING FORCES

(a) **Applicability**

This test is applicable only to devices with integral coaxial connectors.

(b) **Procedure**

The test shall be performed in accordance with ESA/SCC Generic Specification No. 3402, Para. 9.5. References to the 'Detail Specification' shall mean the ESA/SCC 3402/xxx Detail Specification that would define the coaxial connector if it was non-integral.

9.10 CENTRE CONTACT RETENTION

(a) **Applicability**

This test is applicable only to devices with integral coaxial connectors.

(b) **Procedure**

The test shall be performed in accordance with ESA/SCC Generic Specification No. 3402, Para. 9.6. References to the 'Detail Specification' shall mean the ESA/SCC 3402/xxx Detail Specification that would define the coaxial connector if it was non-integral.

N.B.

For the application of an axial force, the force shall be applied to the centre contact only in the direction towards the body of the device under test.

**9.11 RF LEAKAGE**

The test circuit shall be as shown in Figure IV. The test shall be performed in a Faraday cage.

- (a) Apply a suitable fixed amount of RF power, over the frequency range that the device is designed to operate, through the transmission line to the detection circuitry. This value is taken as the reference figure.
- (b) Insert the device under test terminated on adapted loads.
- (c) Use an antenna and "sniff" the component under test.
- (d) Any attenuation less than that specified in the Detail Specification shall be cause for rejection of the component.
- (e) For the test set up, the test circuitry shall be such that the error in measurement quantities are small.

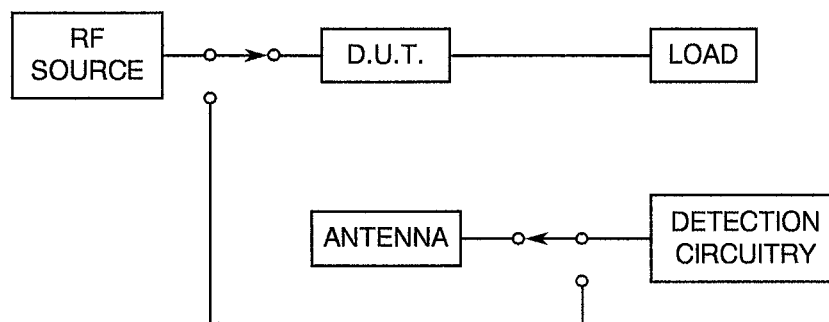
FIGURE IV - RF LEAKAGE TEST SET-UP**9.12 MULTIPACTION****(a) Applicability**

This test is applicable to devices having a gap across which an RF field can be developed and which meet the multipaction test requirement criteria specified below.

The frequency gap product ($f \times d$ in GHz.mm) shall be calculated for the most critical region of the device. The peak voltage across the gap shall then be calculated from the maximum rated (continuous) RF power, as specified in the Detail Specification, and the impedance across the critical gap of the device.

Using the susceptibility curves in Figure V the margin (dB) between the calculated breakdown voltage and the appropriate design curve is found. The need, or otherwise, for testing is as follows:-

1. Margin > 20 dB, no testing is required.
2. 10 dB \leq margin ≤ 20 dB, deliverable devices shall be sample tested, LTPD 7 or lower.
3. 6 dB \leq margin < 10 dB, all deliverable devices shall be tested.
4. Margin < 6 dB, the devices are unsuitable for qualification to this specification.

**(b) Conditions for Testing**

The components shall be subjected to the multipaction test as follows:-

1. Pressure: 1.5×10^{-5} mBar maximum, in the critical area of the device under test.
2. Temperature

When the test is performed 100% it shall be performed at 3 temperatures:

- The minimum operating temperature of the device under test, as specified in the Detail Specification.
- The maximum operating temperature of the device under test, as specified in the Detail Specification.
- Room temperature ($+22 \pm 3$ °C).

When the test is performed on a sample basis it shall be performed only at room temperature ($+22 \pm 3$ °C).

3. Ionising source: Free electrons shall be supplied by a β emitting source (e.g. Sr 90) within the range 100 μ Curie to 10mCurie situated so as to ionise any molecules within the critical area.
4. Cleanliness: Class 100 as specified in ESA PSS-01-201.

(c) Methods of Detection

Multipaction shall be detected by at least 2 of the following methods:-

1. Optical: Detection of ionisation glow by means of an optical fibre/photomultiplier.
2. Electron probe: Detection of free electrons by means of a charged probe.
3. Harmonics: Detection of harmonics generated by the non-linear discharge.
4. Microwave nulling: Increase of sensitivity by phase cancellation of the forward and reflected microwave signals.
5. Noise floor: Detection of noise floor increase with selective filters and a spectrum analyser.
6. Phase noise: Detection of noise increase close to carrier.

(d) Procedure

Starting at a level 3dB below the maximum rated (continuous) power of the device, as specified in the Detail Specification, RF power shall be applied for 5 minutes. The power shall then be increased in steps of 0.5dB up to a level 6dB above the maximum rated (continuous) power of the device, as specified in the Detail Specification. At each step the power shall be held for 5 minutes and multipaction tested for as specified in (c) above. If multipaction is detected, the power shall be reduced and reapplied to verify the threshold. Care must be taken to ensure that the peak power of the device, as specified in the Detail Specification, is not exceeded. Should this be likely, the duty cycle of the applied power shall be reduced. In this case, the noise floor and phase noise methods of detection cannot be used.

An example is shown below to demonstrate the steps to be taken for calculating the margin in dB.

Step 1

Calculate the 'f x d' product for the critical gap in GHz.mm

e.g. 5.3GHz x 1.2mm = 6.36

Step 2

Calculate the peak voltage (V_p) across the critical gap from the maximum rated (continuous) RF power (P) and the impedance (Ω) across the gap using the equation:-

$$V_p = (P \times \Omega \times 2)^{\frac{1}{2}}$$

e.g. $V_P = 30V$

Step 3

Using the susceptibility curves in Figure V obtain the peak voltage value for the 'f x d' product (6.36) using the appropriate curve for the material under consideration, Aluminium shall be chosen for this example.

From Figure V slope (a) is the applicable curve for an 'f x d' product of 6.36. The peak voltage on the curve ($V_p(\text{curve})$) is then calculated using the following equation:-

$$\begin{aligned} V_p(\text{curve}) &= (a) \times (f \times d) \\ &= 40 \times 6.36 \quad (\text{N.B. } 40 \text{ is } (a) \text{ curve value for Aluminium}) \\ &= 254.4V \end{aligned}$$

Step 4

Calculate the margin between the calculated breakdown voltage (V_p) and the peak voltage on the curve ($V_p(\text{curve})$) using the following equation:-

$$\begin{aligned} \text{Margin (in dB)} &= 20 \log_{10} \frac{V_p(\text{curve})}{V_p} \\ &= 20 \log_{10} \frac{254.4}{30} = 18.54\text{dB} \end{aligned}$$

Step 5

Refer to the testing requirements for the margin calculated, to determine whether the testing is required to be performed on a 100%, sample or nil basis.

In this example, deliverable devices shall be sample tested using an LTPD of 7 or lower as the margin falls between the 10 and 20 dB values.

(e) Acceptance Criteria

The devices shall demonstrate a margin of at least 6dB, with no detection of multipaction, over the maximum rated (continuous) power of the device, as specified in the Detail Specification.



FIGURE V - MULTIPACTION SUSCEPTIBILITY ZONES

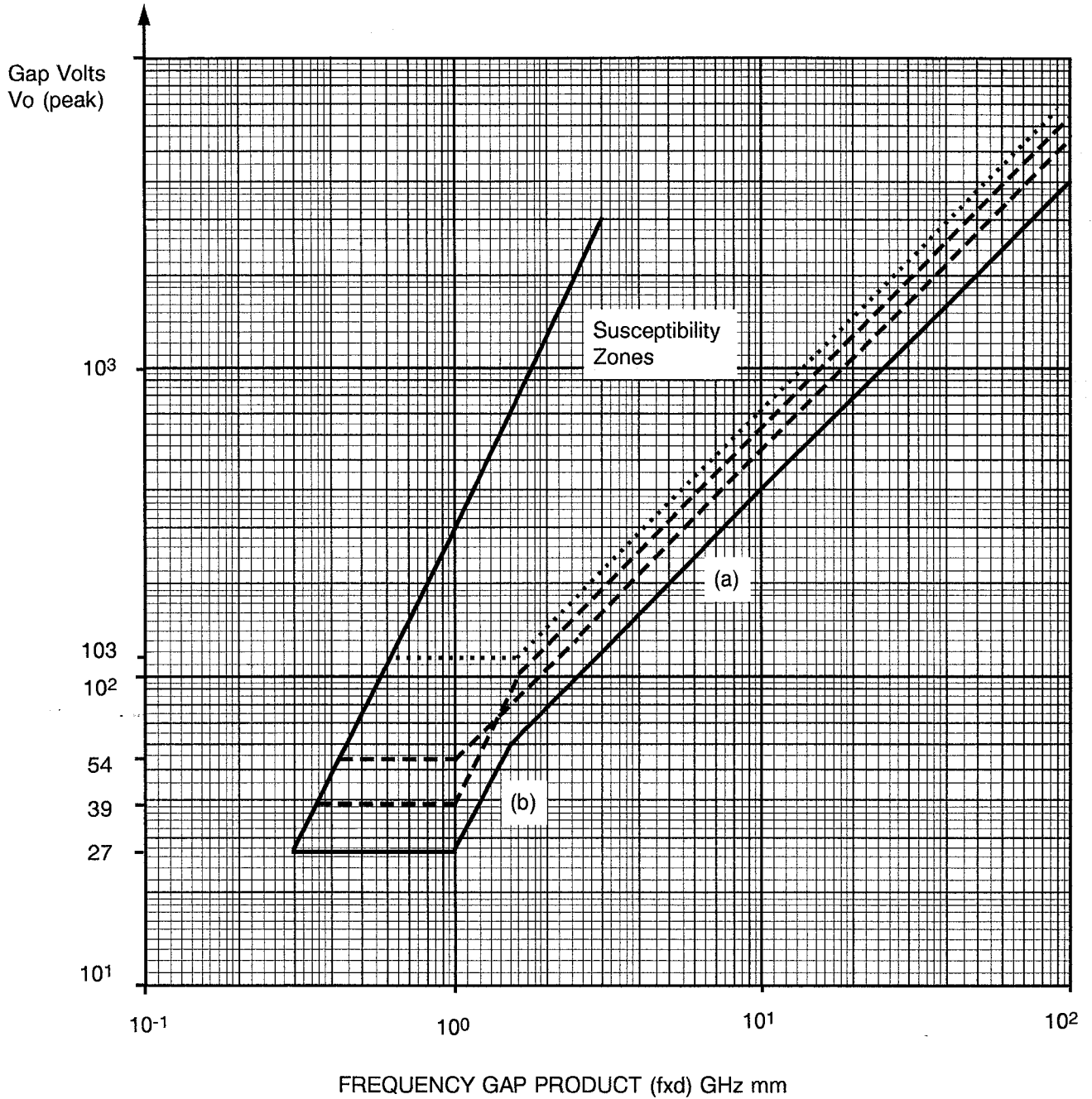

MATERIAL	SLOPE CONSTANTS		
	(a)	(b)	(f x d)
— Aluminium	40	27	1.5
- - - Copper	54	54	1.0
- - - Gold/Silver	63	39	1.6
..... Alodine	74	74	1.5

**9.13 CONTACT ENGAGEMENT AND SEPARATION FORCES****(a) Applicability**

This test is only applicable to connectorised devices, where the connector is female.

(b) Procedure

The test shall be performed in accordance with ESA/SCC Generic Specification No. 3402, Para. 9.3.2. References to the 'Detail Specification' shall mean the ESA/SCC 3402/xxx Detail Specification that defines the applicable coaxial connector interface.

9.14 EXTERNAL VISUAL INSPECTION

In accordance with ESA/SCC Basic Specification No. 20500.

9.15 DIMENSION CHECK

In accordance with ESA/SCC Basic Specification No. 20500 and the Detail Specification. To be performed on 5 samples only.

If a failure occurs, the complete lot shall be checked.

9.16 SHOCK OR BUMP**9.16.1 Shock****(a) Mounting**

As per Para. 9.5.1, the word 'vibration' to be replaced by 'shock'.

(b) Procedure

The components shall be subjected to Test 'Ea' of IEC Publication No. 68-2-27. Unless otherwise specified in the Detail Specification, the following conditions shall apply:

- Shape of shock pulse: Half sine.
- Peak acceleration: 50g.
- Duration of pulse: 11ms.
- Number of shocks: 18 (3 shocks in each direction along the 3 perpendicular axes of the specimen).

(c) Final Measurements

As per Para. 9.5.3, the word 'vibration' to be replaced by 'shock'.

(d) Final Examination

The components shall be examined for evidence of damage or loosening of parts.

9.16.2 Bump**(a) Mounting**

As per Para. 9.5.1, the word 'vibration' to be replaced by 'bump'.

(b) Procedure

The components shall be subjected to Test 'Eb' of IEC Publication No. 68-2-29. Unless otherwise specified in the Detail Specification, the following conditions shall apply:



- Peak acceleration: 390m/s².
- Duration of pulse: 6ms.
- Number of bumps: 4 000 ± 10.

(c) **Final Measurements**

As per Para. 9.5.3, the word 'vibration' to be replaced by 'bump'.

(d) **Final Examination**

The components shall be examined for evidence of damage or loosening of parts.

9.17 PERMANENCE OF MARKING

In accordance with ESA/SCC Basic Specification No. 24800.

9.18 CLIMATIC SEQUENCE

9.18.1 Initial Measurements

No initial measurements are required.

9.18.2 Dry Heat

The components shall be subjected to Test 'Ba' of IEC Publication No. 68-2-2. Duration: 2 hours. Maximum operating temperature as prescribed in the Detail Specification. While still at the specified high temperature and at the end of the period of high temperature, electrical measurements as specified in Table 3 of the Detail Specification shall be performed and shall not exceed the specified limits.

9.18.3 Damp Heat, Accelerated, First Cycle

Unless otherwise specified in the Detail Specification, and after a recovery period of 1 to 24 hours, the components shall be subjected to Test 'Db', Severity b, Variant 2 of IEC Publication No. 68-2-30 for 1 cycle of 24 hours. After a recovery period of 1 to 24 hours, the components shall be subjected immediately to the cold test.

For unsealed devices liable to internal corrosion, the recovery period may be at an elevated temperature no greater than the maximum storage temperature defined in the Detail Specification.

9.18.4 Cold Test

The components shall be subjected to Test 'Aa' of IEC Publication No. 68-2-1. Duration: 2 hours. Minimum operating temperature as prescribed in the Detail Specification. While still at the specified low temperature and at the end of the period of low temperature, electrical measurements as specified in Table 3 of the Detail Specification shall be performed and shall not exceed the specified limits.

9.18.5 Low Air Pressure

(a) **Applicability**

This test is applicable to devices having a gap across which an RF field can be developed.

(b) **Procedure**

The components shall be subjected to Test 'M' of IEC Publication No. 68-2-13 under the following conditions:

- Pressure: The pressure in Torr shall equal the frequency in GHz of the RF signal to be applied, i.e. if the frequency is 5.5GHz then the pressure shall be 5.5 Torr.



- Temperature: Room temperature ($+22 \pm 3$ °C).
- Relative Humidity (RH): The depressurised air shall have a maximum RH of 10%. Maximum rated (continuous) RF power at a frequency as near as practicable to the centre of the operating frequency range of the device, as specified in the Detail Specification, shall be applied for 5 minutes, immediately after the applicable pressure has been attained in the critical areas, i.e. around gaps within the device. During the application of the RF power, the insertion loss shall be monitored for changes indicating that a discharge is occurring.

N.B.

The insertion loss will show a noticeable increase if a discharge occurs.

(c) Acceptance Criteria

No discharge shall occur.

9.18.6 Damp Heat, Accelerated, Remaining Cycles

The components shall be subjected to Test 'Db', Severity b, Variant 2 of IEC Publication No. 68-2-30 for 5 cycles of 24 hours.

9.18.7 Final Measurements

After a recovery period of 1 to 24 hours, electrical measurements as specified in Table 6 of the Detail Specification shall be performed and shall not exceed the specified limits. For unsealed devices liable to internal corrosion the recovery period may be at an elevated temperature no greater than the maximum storage temperature defined in the Detail Specification.

9.19 CORROSION

The components, **equipped with dust covers**, shall be submitted to Test 'Ka' of IEC Publication No. 68-2-11 for 48 hours. After exposure, they shall be brushed with a non-reacting cleaning fluid, shaken, lightly brushed and then allowed to dry at $+40$ °C for 24 hours. The components shall then be inspected and no base metal shall be exposed on the body or the connectors, where applicable. Particular attention shall be paid to the observation of galvanic action.

9.20 OPERATING LIFE**9.20.1 Initial Measurements**

The parameters listed in Table 6 of the Detail Specification shall be measured.

9.20.2 Mounting

The components shall be placed on a rack of thermal insulating material. There shall be no undue draught over the components; only natural convection, resulting from the hot components, may occur.

9.20.3 Procedure

The components shall be submitted to an operating life test of 1000 hours for Chart IV and 500 hours for Chart V. These shall consist of cycles of 1 hour with power 'ON' followed by 1 hour with power 'OFF'. The power applied shall be the maximum rated (continuous) power of the component, as defined in the Detail Specification, at a frequency as near as practicable to the centre of the operating frequency range of the component. Intermediate measurements shall be performed at 500 hours for Chart IV and 250 hours for Chart V.

During the test, the outer surface of the component shall be maintained at the maximum operating temperature as defined in the Detail Specification. At the completion of the test the components shall be allowed to cool to room temperature for not less than 1 hour and not more than 2 hours.

**9.20.4 Final Measurements**

The parameters listed in Table 6 of the Detail Specification shall be measured and shall not exceed the specified limits.

9.21 PEAK POWER

The components shall be placed in still air and free space at room temperature. The peak power, at a frequency as near as practicable to the centre of the operating frequency range of the component (as specified in the Detail Specification), shall be applied 10 times to each line for the time specified in Table 6 of the Detail Specification. After the component has cooled to room temperature, electrical measurements as specified in Table 6 of the Detail Specification shall be performed and shall not exceed the specified limits. The components shall be visually examined for any damage caused by the application of the RF power.

9.22 POWER LEVEL

1.5 times the rated (continuous) power, at a frequency as near as practicable to the centre of the operating frequency range of the component (as specified in the Detail Specification), shall be applied to the components under test and shall be maintained for 15 minutes after the component has reached thermal equilibrium.

Thermal equilibrium has been reached when the temperature of the component has not changed by more than 5°C over a period of 5 minutes. Following the exposure, electrical measurements as specified in Table 6 of the Detail Specification shall be performed and shall not exceed the specified limits. The components shall be visually examined for any damage caused by the application of the RF power.

9.23 HIGH TEMPERATURE STORAGE**9.23.1 Initial Measurements**

The parameters listed in Table 6 of the Detail Specification shall be measured.

9.23.2 Procedure

The components shall be placed in an oven at the maximum storage temperature specified in the Detailed Specification. Intermediate measurements shall be performed at 500 hours. After not less than 1000 hours, they shall be removed from the oven and allowed to cool to room temperature for not less than 1 hour and not more than 2 hours.

9.23.3 Final Measurements

The parameters listed in Table 6 of the Detail Specification shall be measured and shall not exceed the specified limits.

9.24 ENDURANCE**(a) Applicability**

This test is applicable only to devices with integral coaxial connections.

(b) Procedure

The components shall be subjected to the test in accordance with ESA/SCC Generic Specification No. 3402, Para. 9.18. References to the 'Detail Specification' shall mean the ESA/SCC 3402/xxx Detail Specification that would define the coaxial connector if it were non-integral. The connector used for the test shall be either an ESA/SCC qualified connector or shall have the same dimensions, constituent material and plating, although the thickness may vary, as defined in the applicable ESA/SCC 3402/xxx Detail Specification.

	<p style="text-align: center;">ESA/SCC Generic Specification No. 3102</p>	<p style="text-align: center;">Rev. 'C'</p>	<p>PAGE 33 ISSUE 1</p>
---	---	---	----------------------------

10. DATA DOCUMENTATION

10.1 GENERAL

For the qualification approval records and with each component delivery, a data documentation package is required. Depending on the testing level and lot acceptance level specified for the component, this package shall be compiled from:-

- (a) Cover sheet (or sheets).
- (b) List of equipment (testing and measuring).
- (c) List of test references.
- (d) Special in-process control test data.
- (e) Final production test data (Chart II) (but see Para. 10.6).
- (f) Qualification test data (Chart IV).
- (g) Lot acceptance test data (Chart V) (when applicable).
- (h) Failed components list (see Paras. 7.3 and 8.4) and failure analysis report (see Para. 8.4).
- (i) Certificate of Conformity.

Items (a) to (i) inclusive shall be grouped, preferably as subpackages and, for identification purposes, each page shall include the following information:

- ESA/SCC Component Number.
- Manufacturer's name.
- Lot identification.
- Date of establishment of the document.
- Page number.

10.1.1 Qualification Approval

In the case of qualification approval, the items listed in Para. 10.1 (a) to (i) less item (g) are required.

10.1.2 Testing Level 'B'

10.1.2.1 Qualified Components

For deliveries of qualified components, the following documentation shall be supplied:-

- (a) Cover sheet (if all of the information is not included on the Certificate of Conformity).
- (b) Certificate of Conformity (including range of delivered serial numbers).
- (c) Attributes record of measurements, tests and inspections performed in Chart II (including PDA figure) and Chart V (where applicable).
- (d) Failed components list.

10.1.2.2 Unqualified Components

For deliveries of unqualified components, the documentation to be supplied shall be in accordance with Para. 10.1.2.1 plus the following:-

- (a) Read and record data from Chart II (see Para. 10.6.2).
- (b) Special in-process control data (where applicable).
- (c) Failure analysis report on failed components.

10.1.3 Testing Level 'C'

Not applicable.

	SCC	ESA/SCC Generic Specification No. 3102	Rev. 'B'	PAGE 33A ISSUE 1
---	------------	---	----------	---------------------



10.1.4 Data Retention/Data Access

If not delivered, all data shall be retained by the Manufacturer for a minimum of 5 years during which time it shall be available to the Qualifying Space Agency and the Orderer, if requested, for review. The Manufacturer shall deliver variables Data/Reports to the Orderer if required by the Purchase Order.

10.2 COVER SHEET(S)

The cover sheet(s) of the data documentation package shall include as a minimum:-

- (a) Reference to the Detail Specification, including issue and date.
- (b) Reference to the Generic Specification, including issue and date.
- (c) Component type and number.
- (d) Lot identification.
- (e) Range of delivered serial numbers.
- (f) Number of purchase order.
- (g) Information relative to any additions to this specification and/or the Detail Specifications.

 	<p style="text-align: center;">ESA/SCC Generic Specification No. 3102</p>	<p style="text-align: center;">Rev. 'B'</p>	<p>PAGE 34 ISSUE 1</p>
---	---	---	----------------------------

- (h) Manufacturer's name and address.
- (i) Location of the manufacturing plant.
- (j) Signature on behalf of the Manufacturer.
- (k) Total number of pages of the data package.

10.3 LIST OF EQUIPMENT USED

A list of equipment used for tests and measurements shall be prepared, if not in accordance with the data given in the Process Identification Document (PID). Where applicable, this list shall contain inventory number, Manufacturer's type number, serial number, etc. This list shall indicate for which tests such equipment was used.

10.4 LIST OF TEST REFERENCES

This list shall include all Manufacturer's references or codes which are necessary to correlate the test data provided with the applicable tests specified in the tables of the Detail Specification.

10.5 SPECIAL IN-PROCESS CONTROL DATA

The following data shall be provided:



- Stress corrosion results of metallic materials, (Qualification only).
- Results of the plating thickness verification test.
- Results of the braze microsectioning, (when applicable).
- Results of the contact insertion and withdrawal forces, (when applicable).

10.6 FINAL PRODUCTION TEST DATA (CHART II)

10.6.1 Test Result Summary

A test result summary shall be compiled showing the total number of components submitted to, and the total number rejected after, each of the following tests:

- Pre-assembly visual inspection (Para. 9.1).
- Environmental tests (Paras. 9.4.2 and 9.5.2).
- Seal test (Para. 9.6), (when applicable).
- Electrical measurements at room temperature (Para. 9.7.4).
- Electrical measurements at high and low temperatures (Para. 9.7.3).
- Coupling proof torque (Para. 9.8), (when applicable).
- Mating and unmating forces (Para. 9.9), (when applicable).
- Centre contact retention (Para. 9.10), (when applicable).
- RF Leakage (Para. 9.11), (when applicable).
- Multipaction test (Para. 9.12), (when applicable).
- Contact engagement and separation forces (Para. 9.13), (when applicable).
- External visual inspection (Para. 9.14).
- Dimension Check (Para. 9.15).

 	<p style="text-align: center;">ESA/SCC Generic Specification No. 3102</p>	<p style="text-align: center;">Rev. 'B'</p>	<p style="text-align: right;">PAGE 35 ISSUE 1</p>
---	---	---	---

The final production test data shall form an integral part of the data documentation package, but it is not a mandatory requirement that it be delivered with the qualification lot or delivery lot. However, the data package to be delivered shall also contain the information as detailed in Para. 10.1.2 or at least shall contain a list of final production tests actually performed and a certification that the data is available for review.

10.6.2 Testing Level 'B'

For components of testing level 'B', all data shall refer to the relevant serial numbers. Against these serial numbers, actual results, including plots (see Para. 9.7.1.1), shall be recorded of the following:-

- (a) Values obtained during measurement of electrical characteristics (Table 2 of the Detail Specification).
- (b) Values obtained during measurements at high and low temperatures (Table 3 of the Detail Specification).

10.7 BURN-IN AND ELECTRICAL MEASUREMENT DATA (CHART III)

Not applicable.

10.8 QUALIFICATION TEST DATA (CHART IV)

All data shall be referenced to the relevant serial numbers. Detailed records shall be provided of the components submitted to each test in each of the subgroups and of those rejected.

Detailed data shall be provided of all electrical measurements made in accordance with Tables 2 and 6 of the Detail Specification, as and where applicable.

10.9 LOT ACCEPTANCE TEST DATA (CHART V)

10.9.1 Testing Level 'B'

All data shall be referenced to the relevant serial numbers. Detailed records shall be provided of the components submitted to each test in each of the subgroups (as relevant to the lot acceptance level) and of those rejected.

Detailed data shall be provided of all electrical measurements made in accordance with Tables 2, 3 and 6 of the Detail Specification, as and where applicable.



10.9.2 Testing Level 'C'

Not applicable.

10.10 FAILED COMPONENTS LIST AND FAILURE ANALYSIS REPORT

The failed component list and failure analysis report shall provide full details of:-

- (a) The reference number and description of the test or measurement performed as defined in this specification and/or the Detail Specification.
- (b) The serial number (if applicable) of the failed component.
- (c) The failed parameter and the failure mode of the components.
- (d) Detailed failure analysis, if requested.

 	<p style="text-align: center;">ESA/SCC Generic Specification No. 3102</p>	<p style="text-align: center;">Rev. 'B'</p>	<p style="text-align: right;">PAGE 36 ISSUE 1</p>
---	---	---	---

10.11 CERTIFICATE OF CONFORMITY

A Certificate of Conformity shall be established as defined in ESA/SCC Basic Specification No. 20100.

11. DELIVERY

For qualification approval, the disposition of the qualification test lot and its related documentation shall be as specified in ESA/SCC Basic Specification No. 20100 and the relevant paragraphs of Section 10 of this specification.

For procurement, for each order, the items forming the delivery are:-

- (a) The delivery lot.
- (b) The components used for lot acceptance testing, (when applicable), but not forming part of the delivery lot (see Paras. 8.2.3(d), 8.2.4(b) and 8.2.5(b)).
- (c) The relevant documentation in accordance with the requirements of Section 10 of this specification.

In the case of a component for which a valid qualification approval is in force, all data of all components submitted to LA1 and LA2 testing shall also be copied, when requested, to the relevant Qualifying Space Agency.

12. PACKAGING AND DESPATCH

The packaging and despatch of components to this specification shall be in accordance with the requirements of ESA/SCC Basic Specification No. 20600. Silver plated components shall be packed in hermetically sealed silicone-free bags.



ANNEXE I

LTPD SAMPLING PLAN FOR LOT SIZES GREATER THAN 200 DEVICES

Minimum size of sample to be tested to assure with a 90% confidence that a lot whose Percent Defective equals the specified LTPD is not accepted (single sample).

Max. Percent Defective (LTPD) or λ	50	30	20	15	10	7	5	3	2	1.5	1	0.7	0.5	0.3	0.2	0.15	0.1
Acceptance Number (c) ($r = c + 1$)	MINIMUM SAMPLE SIZES (FOR DEVICE-HOURS REQUIRED FOR LIFE TEST, MULTIPLY BY 1000)																
0	5 (1.03)	8 (0.64)	11 (0.46)	15 (0.34)	22 (0.23)	32 (0.16)	45 (0.11)	76 (0.07)	116 (0.04)	153 (0.03)	231 (0.02)	328 (0.02)	461 (0.01)	767 (0.007)	1152 (0.005)	1534 (0.003)	2303 (0.002)
1	8 (4.4)	13 (2.7)	18 (2.0)	25 (1.4)	38 (0.94)	55 (0.65)	77 (0.46)	129 (0.28)	195 (0.18)	258 (0.14)	390 (0.09)	555 (0.06)	778 (0.045)	1296 (0.027)	1946 (0.018)	2592 (0.013)	3891 (0.009)
2	11 (7.4)	18 (4.5)	25 (3.4)	34 (2.24)	52 (1.6)	75 (1.1)	105 (0.78)	176 (0.47)	266 (0.31)	354 (0.23)	533 (0.15)	759 (0.11)	1065 (0.080)	1773 (0.045)	2662 (0.031)	3547 (0.022)	5323 (0.015)
3	13 (10.5)	22 (6.2)	32 (4.4)	43 (3.2)	65 (2.1)	94 (1.5)	132 (1.0)	221 (0.62)	333 (0.41)	444 (0.31)	668 (0.20)	953 (0.14)	1337 (0.10)	2226 (0.062)	3341 (0.041)	4452 (0.031)	6681 (0.018)
4	16 (12.3)	27 (7.3)	38 (5.3)	52 (3.9)	78 (2.6)	113 (1.8)	158 (1.3)	265 (0.75)	398 (0.50)	531 (0.37)	798 (0.25)	1140 (0.17)	1599 (0.12)	2663 (0.074)	3997 (0.049)	5327 (0.037)	7994 (0.025)
5	19 (13.8)	31 (8.4)	45 (6.0)	60 (4.4)	91 (2.9)	131 (2.0)	184 (1.4)	308 (0.85)	462 (0.57)	617 (0.42)	927 (0.28)	1323 (0.20)	1855 (0.14)	3090 (0.085)	4638 (0.056)	6181 (0.042)	9275 (0.028)
6	21 (15.6)	35 (9.4)	51 (6.6)	68 (4.9)	104 (3.2)	149 (2.2)	209 (1.6)	349 (0.94)	528 (0.62)	700 (0.47)	1054 (0.31)	1503 (0.22)	2107 (0.155)	3509 (0.093)	5267 (0.062)	7019 (0.047)	10533 (0.031)
7	24 (16.6)	39 (10.2)	57 (7.2)	77 (5.3)	116 (3.5)	166 (2.4)	234 (1.7)	390 (1.0)	589 (0.67)	783 (0.51)	1178 (0.34)	1680 (0.24)	2355 (0.17)	3922 (0.101)	5886 (0.067)	7845 (0.051)	11771 (0.034)
8	26 (18.1)	43 (10.9)	63 (7.7)	85 (5.6)	128 (3.7)	184 (2.6)	258 (1.8)	431 (1.1)	648 (0.72)	864 (0.54)	1300 (0.36)	1854 (0.25)	2599 (0.18)	4329 (0.108)	6498 (0.072)	8660 (0.054)	12995 (0.036)
9	28 (19.4)	47 (11.5)	69 (8.1)	93 (6.0)	140 (3.9)	201 (2.7)	282 (1.9)	471 (1.2)	709 (0.77)	945 (0.58)	1421 (0.38)	2027 (0.27)	2842 (0.19)	4733 (0.114)	7103 (0.077)	9468 (0.057)	14206 (0.038)
10	31 (19.9)	51 (12.1)	75 (8.4)	100 (6.3)	152 (4.1)	218 (2.9)	306 (2.0)	511 (1.2)	770 (0.80)	1025 (0.60)	1541 (0.40)	2199 (0.28)	3082 (0.20)	5133 (0.120)	7704 (0.080)	10268 (0.060)	15407 (0.040)
11	33 (21.0)	54 (12.8)	83 (8.3)	111 (6.2)	166 (4.2)	238 (2.9)	332 (2.1)	555 (1.2)	832 (0.83)	1109 (0.62)	1664 (0.42)	2378 (0.29)	3323 (0.21)	5546 (0.12)	8319 (0.083)	11092 (0.062)	16638 (0.042)
12	36 (21.4)	59 (13.0)	89 (8.6)	119 (6.5)	178 (4.3)	254 (3.0)	356 (2.2)	594 (1.3)	890 (0.86)	1187 (0.65)	1781 (0.43)	2544 (0.3)	3562 (0.22)	5936 (0.13)	8904 (0.086)	11872 (0.065)	17808 (0.043)
13	38 (22.3)	63 (13.4)	95 (8.9)	126 (6.7)	190 (4.5)	271 (3.1)	379 (2.26)	632 (1.3)	948 (0.89)	1264 (0.67)	1896 (0.44)	2709 (0.31)	3793 (0.22)	6321 (0.134)	9482 (0.089)	12643 (0.067)	18964 (0.045)
14	40 (23.1)	67 (13.8)	101 (9.2)	134 (6.9)	201 (4.6)	288 (3.2)	403 (2.3)	672 (1.4)	1007 (0.92)	1343 (0.69)	2015 (0.46)	2878 (0.32)	4029 (0.23)	6716 (0.138)	10073 (0.092)	13431 (0.069)	20146 (0.046)
15	43 (23.3)	71 (14.1)	107 (9.4)	142 (7.1)	213 (4.7)	305 (3.3)	426 (2.36)	711 (1.41)	1066 (0.94)	1422 (0.71)	2133 (0.47)	3046 (0.33)	4265 (0.235)	7108 (0.141)	10662 (0.094)	14216 (0.070)	21324 (0.047)
16	45 (24.1)	74 (14.0)	112 (9.7)	150 (7.2)	225 (4.8)	321 (3.37)	450 (2.41)	750 (1.44)	1124 (0.96)	1499 (0.72)	2249 (0.48)	3212 (0.337)	4497 (0.241)	7496 (0.144)	11244 (0.096)	14992 (0.072)	22487 (0.048)
17	47 (24.7)	79 (14.7)	118 (9.86)	158 (7.36)	236 (4.93)	338 (3.44)	473 (2.46)	788 (1.48)	1182 (0.98)	1576 (0.74)	2364 (0.49)	3377 (0.344)	4728 (0.246)	7880 (0.148)	11819 (0.098)	15759 (0.074)	23639 (0.049)
18	50 (24.9)	83 (15.0)	124 (10.0)	165 (7.54)	248 (5.02)	354 (3.51)	496 (2.51)	826 (1.51)	1239 (1.0)	1652 (0.75)	2478 (0.50)	3541 (0.351)	4956 (0.251)	8260 (0.151)	12390 (0.100)	16520 (0.075)	24780 (0.050)
19	52 (25.5)	86 (15.4)	130 (10.2)	173 (7.76)	259 (5.12)	370 (3.58)	518 (2.56)	864 (1.53)	1296 (1.02)	1728 (0.77)	2591 (0.52)	3702 (0.358)	5183 (0.256)	8638 (0.153)	12957 (0.102)	17276 (0.077)	25914 (0.051)
20	54 (26.1)	90 (15.6)	135 (10.4)	180 (7.82)	271 (5.19)	386 (3.65)	541 (2.60)	902 (1.56)	1353 (1.04)	1803 (0.78)	2705 (0.52)	3864 (0.364)	5410 (0.260)	9017 (0.156)	13526 (0.104)	18034 (0.078)	27051 (0.052)
26	65 (27.0)	109 (16.1)	163 (10.8)	217 (8.08)	326 (5.38)	466 (3.76)	652 (2.69)	1086 (1.61)	1629 (1.08)	2173 (0.807)	3259 (0.538)	4656 (0.376)	6518 (0.269)	10863 (0.161)	16295 (0.108)	21726 (0.081)	32589 (0.054)



ANNEXE I

LTPD SAMPLING PLAN FOR LOT SIZES LESS THAN, OR EQUAL TO, 200 DEVICES

C=0													
N	10	20	30	40	50	60	80	100	120	150	160	200	
n	AQL LTPD	AQL LTPD	AQL LTPD	AQL LTPD	AQL LTPD	AQL LTPD	AQL LTPD	AQL LTPD	AQL LTPD	AQL LTPD	AQL LTPD	AQL LTPD	AQL LTPD
2	2.2 65	2.5 66	2.5 67	2.5 67	2.5 67	2.5 68	2.5 68	2.5 68	2.5 68	2.5 68	2.5 68	2.5 68	2.5 68
4	1.2 36	1.2 40	1.2 42	1.2 42	1.3 42	1.3 43	1.3 43	1.3 43	1.3 43	1.3 43	1.3 43	1.3 44	1.3 44
5	1.0 29	1.0 33	1.0 34	1.0 35	1.0 35	1.0 35	1.0 36	1.0 36	1.0 37	1.0 37	1.0 37	1.0 37	1.0 37
8	0.5 15	0.6 20	0.6 22	0.6 23	0.6 23	0.6 23	0.6 24	0.7 24	0.7 24	0.7 24	0.7 24	0.7 24	0.7 25
10		0.4 15	0.5 17	0.5 19	0.5 19	0.5 19	0.5 20	0.5 20	0.5 20	0.5 20	0.5 20	0.5 20	0.5 20
16		0.2 6.9	0.25 10	0.25 11	0.3 11	0.3 12	0.3 12	0.3 13	0.3 13	0.3 13	0.3 13	0.3 13	0.3 13
20			0.2 6.8	0.2 8.0	0.25 8.7	0.25 9.0	0.25 9.4	0.25 10	0.25 10	0.25 10	0.25 10	0.25 10	0.25 11
25			0.15 4.3	0.15 5.7	0.2 6.4	0.2 6.9	0.2 7.4	0.2 7.5	0.2 7.6	0.2 7.7	0.2 7.8	0.2 7.8	0.2 7.9
32				0.1 3.7	0.1 4.4	0.1 5.0	0.1 5.5	0.1 5.9	0.15 6.0	0.15 6.2	0.15 6.3	0.15 6.3	0.15 6.3
40					0.1 3.0	0.1 3.4	0.1 4.0	0.1 4.5	0.1 4.6	0.1 4.9	0.1 5.0	0.1 5.0	0.15 5.0
50						0.1 2.3	0.1 2.9	0.10 3.3	0.10 3.5	0.10 3.7	0.10 3.7	0.10 3.7	0.10 3.9
64							0.08 1.7	0.08 2.2	0.08 2.5	0.08 2.7	0.08 2.8	0.08 2.8	0.08 2.9
80								0.07 1.5	0.07 1.7	0.07 2.0	0.07 2.1	0.07 2.1	0.07 2.2
100									0.05 1.1	0.05 1.5	0.05 1.5	0.05 1.5	0.05 1.7
125										0.04 0.8	0.04 0.9	0.04 0.9	0.04 1.2
128											0.04 0.8	0.04 0.9	0.04 1.1
160													0.03 0.7
C=1													
N	10	20	30	40	50	60	80	100	120	150	160	200	
n	AQL LTPD	AQL LTPD	AQL LTPD	AQL LTPD	AQL LTPD	AQL LTPD	AQL LTPD	AQL LTPD	AQL LTPD	AQL LTPD	AQL LTPD	AQL LTPD	AQL LTPD
2	27 95	24 95	24 95	23 95	23 95	23 95	23 95	23 95	23 95	22 95	22 95	22 95	22 95
4	15 62	12 66	12 66	11 67	11 67	10 67	10 67	10 67	10 67	9.8 67	9.7 67	9.7 68	9.7 68
5	13 51	10 55	8.8 56	8.5 57	8.4 57	8.1 58	7.9 58	7.6 58	7.5 58	7.5 58	7.5 58	7.5 58	7.5 58
8	11 28	7.2 35	6.2 38	5.8 38	5.4 39	5.0 39	4.7 39	4.5 39	4.3 39	4.3 40	4.2 40	4.2 40	4.2 40
10		6.2 30	5.0 30	4.6 31	4.2 32	4.2 32	4.2 32	3.9 33	3.5 33	3.3 33	3.3 33	3.3 33	3.3 33
16		5.6 15	4.2 18	3.8 18	3.4 20	3.0 20	2.9 21	2.6 21	2.5 21	2.3 21	2.3 22	2.2 22	2.2 22
20			4.0 13	3.2 15	2.8 16	2.5 16	2.4 16	2.3 16	2.1 17	2.0 17	2.0 17	2.0 18	2.0 18
25			3.8 9.2	3.1 11	2.5 12	2.2 13	2.0 13	1.8 13	1.7 13	1.6 14	1.6 14	1.6 14	1.6 14
32				3.1 7.4	2.4 8.2	2.1 9.0	1.8 9.9	1.6 10	1.5 10.5	1.4 11	1.3 11	1.3 11	1.3 11
40					2.4 5.9	2.1 6.8	1.6 7.6	1.4 7.8	1.3 8.2	1.2 8.3	1.2 8.4	1.2 8.6	1.2 8.6
50						1.7 4.6	1.4 5.6	1.2 6.1	1.2 6.4	1.0 6.5	0.9 6.7	0.9 6.7	0.9 6.7
64							1.3 3.8	1.1 4.4	1.0 4.7	0.8 5.0	0.8 5.0	0.7 5.2	0.7 5.2
80								1.1 3.0	1.0 3.4	0.8 3.7	0.7 3.8	0.6 4.0	0.6 4.0
100									0.9 2.5	0.7 2.8	0.7 2.8	0.6 3.0	0.6 3.0
125										0.7 1.9	0.7 2.0	0.5 2.2	0.5 2.2
128										0.7 1.7	0.7 1.9	0.5 2.2	0.5 2.2
160												0.5 1.5	0.5 1.5
C=2													
N	10	20	30	40	50	60	80	100	120	150	160	200	
n	AQL LTPD	AQL LTPD	AQL LTPD	AQL LTPD	AQL LTPD	AQL LTPD	AQL LTPD	AQL LTPD	AQL LTPD	AQL LTPD	AQL LTPD	AQL LTPD	AQL LTPD
4	33 82	28 83	27 84	27 85	27 85	26 85	26 85	26 86	26 86	25 86	25 86	25 86	25 86
5	27 69	23 73	21 74	20 74	20 74	20 75	20 75	19 75	19 75	19 75	19 75	19 75	19 75
8	22 42	15 49	14 49	13 52	13 52	13 52	12 53	12 53	12 53	11 53	11 53	11 53	11 53
10		13 39	11 42	11 42	10 43	10 43	9.6 43	9.2 44	9.1 44	8.9 44	8.9 44	8.7 44	8.7 44
16		11 22	8.6 25	6.9 27	6.8 27	6.4 27	6.0 28	6.0 29	5.9 29	5.9 29	5.7 29	5.5 30	5.5 30
20			7.7 19	6.2 21	5.9 22	5.6 22	5.1 23	4.8 23	4.8 23	4.6 23	4.5 24	4.5 24	4.5 24
25			7.4 13	6.0 16	4.9 17	4.5 17	4.3 18	4.1 18	3.9 18	3.7 18	3.7 19	3.7 19	3.7 19
32				5.5 11	4.8 12	4.3 13	3.6 14	3.4 14	3.2 14	3.0 14.5	3.0 15	2.9 15	2.9 15
40					4.6 8.9	3.9 9.8	3.1 11	2.8 12	2.6 12	2.4 12	2.4 12	2.3 12	2.3 12
50						3.5 6.9	2.8 8.1	2.4 8.4	2.3 8.6	2.1 9.0	2.1 9.3	2.0 9.5	2.0 9.5
64							2.6 5.7	2.2 6.2	2.0 6.6	1.8 7.1	1.7 7.1	1.6 7.4	1.6 7.4
80								2.1 4.5	1.8 4.9	1.6 5.4	1.5 5.4	1.4 5.6	1.4 5.6
100									1.8 3.5	1.4 3.9	1.4 4.0	1.2 4.4	1.2 4.4
125										1.4 2.8	1.3 2.9	1.1 3.3	1.1 3.3
128										1.4 2.6	1.3 2.9	1.1 3.2	1.1 3.2
160												1.1 2.3	1.1 2.3

**SCC**ESA/SCC Generic Specification
No. 3102

PAGE 39

ISSUE 1

ANNEXE I**Page 3 of 3**

This table gives the AQL and LTPD values associated with certain single sampling plans (Acceptance Number "C", Sample Size "n" and Lot Size "N"). The table has the following features:-

- (a) Calculations are based upon the hyper-geometric distribution (exact theory) for lot sizes of 200 devices or less.
- (b) The AQL of a sampling plan is defined as the interpolated Percent Defective for which there is 0.95 probability of acceptance under the plan. The AQL so defined need not be a realisable Lot Percent Defective for the lot size involved (e.g., 12 percent is not a realisable Percent Defective for a lot size of 20 devices).
- (c) The LTPD of a sampling plan is defined as the interpolated Percent Defective for which there is a 0.10 probability of lot acceptance under the plan. The LTPD so defined need not be a realisable Lot Percent Defective for the lot size involved.
- (d) The sequence of sample sizes and lot sizes are generated by taking products of preceding numbers in the respective sequences and the numbers 2 and 5.