



europaean space agency  
agence spatiale européenne

Pages 1 to 38

**SURFACE ACOUSTIC WAVE (SAW)**

**DEVICES (FILTERS)**


**ESA/SCC Generic Specification No. 3502**



**space components  
coordination group**

Issue/Rev.	Date	Approved by	
		SCCG Chairman	ESA Director General or his Deputy
Issue 2	August 1997		
Revision 'A'	April 1999		



 <b>SCC</b>	ESA/SCC Generic Specification No. 3502		PAGE 3 ISSUE 2
--	---	--	-------------------

## TABLE OF CONTENTS

	<u>Page</u>
<b>1.     <u>INTRODUCTION</u></b>	<b>7</b>
1.1    Scope	7
1.2    Applicability	7
<b>2.     <u>APPLICABLE DOCUMENTS</u></b>	<b>7</b>
2.1    ESA/SCC Specifications	7
2.2    Other (Reference) Documents	8
2.3    Order of Precedence	8
<b>3.     <u>TERMS, DEFINITIONS, ABBREVIATIONS, SYMBOLS AND UNITS</u></b>	<b>8</b>
<b>4.     <u>REQUIREMENTS</u></b>	<b>8</b>
4.1    General	8
4.1.1   Specifications	8
4.1.2   Conditions and Methods of Test	8
4.1.3   Manufacturer's Responsibility for Performance of Tests and Inspections	9
4.1.4   Inspection Rights	9
4.1.5   Pre-encapsulation Inspection	9
4.1.6   Incorporated Chip Components	9
4.2    Qualification Approval Requirements on a Manufacturer	9
4.3    Deliverable Components	9
4.3.1   Lot Failure	10
4.3.2   Testing and Lot Acceptance Levels	10
4.4    Marking	10
4.5    Materials and Finishes	11
<b>5.     <u>PRODUCTION CONTROL</u></b>	<b>11</b>
5.1    General	11
5.2    Special In-process Controls	11
5.2.1   Rebonding	11
5.2.2   Adhesion of Metallisation to Substrate	11
5.2.3   Verification of Adhesive Strength	11
5.2.4   Total Dose Irradiation Testing	11
5.2.5   Documentation	11
<b>6.     <u>FINAL PRODUCTION TESTS</u></b>	<b>13</b>
6.1    General	13
6.2    Test Methods and Conditions	13
6.3    Documentation	13
<b>7.     <u>BURN-IN AND ELECTRICAL MEASUREMENTS</u></b>	<b>13</b>
7.1    General	13
7.1.1   Conditions of Test	13
7.1.2   Data Points	13
7.2    Failure Criteria	14
7.2.1   Parameter Drift Failure	14
7.2.2   Parameter Limit Failure	14
7.2.3   Other Failures	14
7.3    Failed Components	14
7.4    Lot Failure	14
7.4.1   Lot Failure during 100% Testing	14




	<u>Page</u>
7.4.2 Lot Failure during Sample Testing	14
7.5 Documentation	15
<b>8. <u>QUALIFICATION APPROVAL AND LOT ACCEPTANCE TESTS</u></b>	<b>15</b>
8.1 Qualification Testing	15
8.1.1 General	15
8.1.2 Distribution within the Qualification Test Lot	15
8.2 Lot Acceptance Testing	15
8.2.1 General	15
8.2.2 Distribution within the Sample for Lot Acceptance Testing	15
8.2.3 Lot Acceptance Level 3 Testing	16
8.2.4 Lot Acceptance Level 2 Testing	16
8.2.5 Lot Acceptance Level 1 Testing	16
8.3 Failure Criteria	16
8.3.1 Environmental and Mechanical Test Failures	17
8.3.2 Electrical Failures	17
8.3.3 Other Failures	17
8.4 Failed Components	17
8.5 Lot Failure	17
8.6 Documentation	17
<b>9. <u>TEST METHODS AND PROCEDURES</u></b>	<b>22</b>
9.1 Internal Visual Inspection	22
9.2 Bond Strength Test	22
9.2.1 Bond Strength Test during Final Production Tests	22
9.2.2 Bond Strength Test during Qualification Testing	22
9.3 Encapsulation	22
9.4 Rapid Change of Temperature	22
9.4.1 General	22
9.4.2 Final Examination	23
9.5 Constant Acceleration	23
9.5.1 Mounting	23
9.5.2 Procedure	23
9.5.3 Final Measurements during Charts IV and V	23
9.5.4 Final Examination	23
9.6 Particle Impact Noise Detection	23
9.7 Seal Test	24
9.7.1 Fine Leak	24
9.7.2 Gross Leak	24
9.8 Electrical Measurements	24
9.8.1 Electrical Test Methods	24
9.8.2 Parameter Drift Value Measurements	27
9.8.3 Electrical Measurements at High and Low Temperatures	27
9.8.4 Electrical Measurements at Room Temperature	27
9.8.5 Electrical Measurements during Endurance Testing	27
9.9 External Visual Inspection	27
9.10 Dimension Check	28
9.11 Burn-in	28
9.12 Radiographic Inspection	28
9.13 Vibration	28
9.14 Shock or Bump	28
9.14.1 Shock	28
9.14.2 Bump	29



	<u>Page</u>
9.15 Permanence of Marking	29
9.16 Climatic Sequence	29
9.16.1 Initial Measurements	29
9.16.2 Dry Heat	29
9.16.3 Damp Heat, Accelerated, First Cycle	29
9.16.4 Cold Test	29
9.16.5 Damp Heat, Accelerated, Remaining Cycles	30
9.16.6 Recovery and Final Inspection	30
9.16.7 Final Measurements	30
9.17 Solderability	30
9.18 Robustness of Terminations	30
9.19 Operating Life	30
9.19.1 Operating Life during Qualification Testing	30
9.19.2 Operating Life during Lot Acceptance Testing	30
9.20 High Temperature Storage	30
<b>10. <u>DATA DOCUMENTATION</u></b>	<b>31</b>
10.1 General	31
10.1.1 Qualification Approval	31
10.1.2 Testing Level 'B'	31
10.1.3 Testing Level 'C'	32
10.1.4 Data Retention/Data Access	32
10.2 Cover Sheet(s)	32
10.3 List of Equipment Used	33
10.4 List of Test References	33
10.5 Special In-process Control Data	33
10.6 Final Production Test Data	33
10.7 Burn-in and Electrical Measurement Data	33
10.7.1 Testing Level 'B'	33
10.7.2 Testing Level 'C'	34
10.8 Qualification Test Data	34
10.9 Lot Acceptance Test Data	34
10.9.1 Testing Level 'B'	34
10.9.2 Testing Level 'C'	34
10.10 Failed Component List and Failure Analysis Report	34
10.11 Certificate of Conformity	35
<b>11. <u>DELIVERY</u></b>	<b>35</b>
<b>12. <u>PACKAGING AND DESPATCH</u></b>	<b>35</b>



	<u>Page</u>
<b><u>CHARTS</u></b>	
I TESTING LEVELS	12
II FINAL PRODUCTION TESTS	18
III BURN-IN AND ELECTRICAL MEASUREMENTS	19
IV QUALIFICATION TESTS	20
V LOT ACCEPTANCE TESTS	21
<b><u>FIGURES</u></b>	
I INSERTION LOSS, IN-BAND RIPPLE, OUT-OF-BAND REJECTION AND PHASE LINEARITY TEST SET-UP	25
II INSERTION LOSS AND IN-BAND RIPPLE, TYPICAL PLOT	25
III OUT-OF-BAND REJECTION, TYPICAL PLOT	26
IV PHASE LINEARITY, TYPICAL PLOT	26
V RETURN LOSS TEST SET-UP	27
<b><u>ANNEXES</u></b>	
I LTPD SAMPLING PLAN FOR LOT SIZES GREATER THAN 200 DEVICES	36
LTPD SAMPLING PLAN FOR LOT SIZES LESS THAN OR EQUAL TO 200 DEVICES	37

	<p style="text-align: center;">ESA/SCC Generic Specification No. 3502</p>	<p>PAGE 7 ISSUE 2</p>
---	---	---------------------------

**1. INTRODUCTION**

**1.1 SCOPE**

This specification defines the general requirements for the qualification approval, procurement, including lot acceptance testing, and delivery of Surface Acoustic Wave (SAW) Devices (Filters), suitable for space application.

This specification contains the appropriate inspection and test schedules and also specifies the data documentation requirements.

**1.2 APPLICABILITY**

This specification is primarily applicable to the granting of qualification approval to a component in accordance with ESA/SCC Basic Specification No. 20100 and the procurement of such components from qualified Manufacturers.

**2. APPLICABLE DOCUMENTS**

The following documents form part of, and shall be read in conjunction with, this specification. The relevant issues shall be those in effect at the date of placing the purchase order.

**2.1 ESA/SCC SPECIFICATIONS**

No. 20100, Requirements for the Qualification of Standard Electronic Components for Space Application.

No. 20400, Internal Visual Inspection.

No. 20500, External Visual Inspection.

No. 20600, Preservation, Packaging and Despatch of SCC Electronic Components.

No. 20900, Radiographic Inspection.

No. 21300, Terms, Definitions, Abbreviations, Symbols and Units.

No. 21700, General Requirements for the Marking of SCC Components.

No. 22800, ESA/SCC Non-conformance Control System.

No. 22900, Total Dose Steady-State Irradiation Test Method.

No. 23500, Requirements for Lead Materials and Finishes for Components for Space Application.



No. 24600, Minimum Quality System Requirements.

No. 24800, Resistance to Solvents of Marking, Materials and Finishes.

With the exception of ESA/SCC Basic Specification Nos. 20100, 21700, 22800 and 24600, where Manufacturers' specifications are equivalent to, or more stringent than, the ESA/SCC Basic Specifications listed above, they may be used in place of the latter, subject to the approval of the appropriate Qualifying Space Agency.

Such replacements will be clearly identified in the applicable Process Identification Document (P.I.D.) and listed in an appendix to the appropriate Detail Specification.

Unless otherwise stated herein, references within the text of this specification to "the Detail Specification" shall mean the relevant ESA/SCC Detail Specification.

		<p>ESA/SCC Generic Specification No. 3502</p>	<p>PAGE 8 ISSUE 2</p>
---	---	---	---------------------------

## 2.2 OTHER (REFERENCE) DOCUMENTS

ESA PSS-01-702, A Thermal Vacuum Test for the Screening of Space Materials.

ESA PSS-01-713, Measurement of the Peel and Pull-off Strengths of Coatings and Finishes with Pressure Sensitive Tapes.

IEC Publication No. 68, Basic Environmental Testing Procedures.

IEC Publication No. 749, Semiconductor Devices - Mechanical and Climatic Test Methods.

IEC Publication No. 410, Sampling Procedures and Tables for Inspection by Attributes or,

MIL-STD-105, Sampling Procedures and Tables for Inspection by Attributes.

MIL-STD-883, Test Methods and Procedures for Micro-electronics.

## 2.3 ORDER OF PRECEDENCE

For the purpose of interpretation and in case of conflict with regard to documentation, the following order of precedence shall apply:-

- (a) ESA/SCC Detail Specification.
- (b) ESA/SCC Generic Specification.
- (c) ESA/SCC Basic Specification.
- (d) Other documents, if referenced herein.

## 3. TERMS, DEFINITIONS, ABBREVIATIONS, SYMBOLS AND UNITS

The terms, definitions, abbreviations, symbols and units specified in ESA/SCC Basic Specification No. 21300 shall apply.

## 4. REQUIREMENTS

### 4.1 GENERAL

The test requirements for qualification approval of a component shall comprise radiation tests (see Para. 5.2.4), final production tests (see Chart II), burn-in and electrical measurements to testing level 'B' (see Chart III) and qualification testing (see Chart IV).

The test requirements for procurement of components shall comprise radiation tests (see Para. 5.2.4) if specified by the Orderer, final production tests (Chart II), burn-in and electrical measurements to testing level 'B' or 'C' as required (Chart III) together with, when applicable, a level of lot acceptance testing (see Chart V) to be specified by the Orderer.

If a Manufacturer elects to eliminate a final production test by substituting an in-process control or statistical process control procedure, the Manufacturer is still responsible for delivering components that meet all of the performance, quality and reliability requirements defined in this specification and the Detail Specification.

The qualification status of the procured components shall not be impaired by variations in the level of radiation testing called for in the purchase order.



#### 4.1.1 Specifications

For qualification approval, procurement (including lot acceptance testing) and delivery of components in conformity with this specification, the applicable specifications listed in Section 2 of this document shall apply in total unless otherwise specified herein or in the Detail Specification.

#### 4.1.2 Conditions and Methods of Test

The conditions and methods of test shall be in accordance with this specification, the ESA/SCC Basic Specifications referenced herein and the Detail Specification.



 	<p style="text-align: center;">ESA/SCC Generic Specification No. 3502</p>		<p>PAGE 9 ISSUE 2</p>
---	---	--	---------------------------

4.1.3 Manufacturer's Responsibility for Performance of Tests and Inspections

The Manufacturer shall be responsible for the performance of tests and inspections required by the applicable specifications. These tests and inspections shall be performed at the plant of the Manufacturer of the components unless it is agreed by the Qualifying Space Agency prior to commencing qualification testing, or procurement, to use an approved external facility.

4.1.4 Inspection Rights

The Qualifying Space Agency (for qualification approval or for a procurement) reserves the right to monitor any of the tests and inspections scheduled in the applicable specifications.

4.1.5 Pre-encapsulation Inspection

The Manufacturer shall notify the Orderer at least 2 working weeks before the commencement of the pre-encapsulation inspection.

The Orderer shall indicate immediately whether or not he intends to witness the inspection.

4.1.6 Incorporated Chip Components

Incorporated chip components for the SAW devices covered by this specification are those chip components which are completed to such a stage that they may be subjected fully to the requirements of Tables 2 and 3 of an ESA/SCC Detail Specification. Chip components shall be selected using the following preferences:-

- (a) Components qualified by ESA/SCC (see ESA/SCC QPL).
- (b) All other components.

Components selected under (b) because of the non-availability of suitably qualified chip components shall be qualified separately in accordance with an ESA/SCC Generic Specification representative of the type of component selected, and an ESA/SCC Detail Specification for the component selected. If an ESA/SCC Detail Specification does not exist for a selected chip component, a specification shall be written and approved prior to the commencement of this qualification.

The procurement of chip components shall be in accordance with the appropriate ESA/SCC Generic and Detail Specifications.

4.2 QUALIFICATION APPROVAL REQUIREMENTS ON A MANUFACTURER



To obtain and maintain the qualification approval of a component, or family of components, a Manufacturer shall satisfy the requirements of ESA/SCC Basic Specification No. 20100.

4.3 DELIVERABLE COMPONENTS

Components delivered to this specification shall be processed and inspected in accordance with the relevant Process Identification Document (P.I.D.). Each delivered component shall be traceable to its production lot. Components delivered to this specification shall have completed satisfactorily all tests to the testing level and lot acceptance level specified in the purchase order (see Para. 4.3.2).

ESA/SCC qualified components delivered to this specification shall be produced from lots that are capable of passing all tests, and sequences of tests, that are defined in Charts IV and V. The Manufacturer shall not knowingly supply components that cannot meet this requirement. In the event that, subsequent to delivery and prior to operational use, a component is found to be in a condition such that it could not have passed these tests at the time of manufacture, this shall be grounds for rejection of the delivered lot.

Components failing inspections and tests of the higher testing level (i.e. level 'B') shall not be supplied against any order for components of the lower testing level.

		<p>ESA/SCC Generic Specification No. 3502</p>	<p>PAGE 10</p>
			<p>ISSUE 2</p>

Components produced from lots where samples have failed the specified level of radiation testing shall not be delivered against orders requiring a lower level of radiation testing unless data is available to demonstrate that the samples passed that lower level. Should such data not be available, components shall not be delivered against orders requiring a lower level of radiation testing unless a sample is first retested to that lower level.

#### 4.3.1 Lot Failure

Lot failure may occur during special in-process controls (Para. 5), final production tests (Chart II), burn-in and electrical measurements (Chart III), qualification testing (Chart IV) or lot acceptance testing (Chart V).

Should such failure occur, the non-conformance procedure shall be initiated in accordance with ESA/SCC Basic Specification No. 22800.

Should such failure occur during procurement, the Manufacturer shall notify the Orderer by telex within 2 working days, giving details of the number and mode of failure and the suspected cause.

In the case where qualification approval has been granted to the component, he shall, at the same time by the same means, inform the Qualifying Space Agency in order that the latter may consider its implications. No further testing shall be performed on the failed components except on instructions from the Orderer. The Orderer shall inform the Manufacturer and the Qualifying Space Agency within 2 working days of receipt of the telex, by the same means what action shall be taken.

In the case where lot failure occurs during qualification testing, the Manufacturer shall immediately notify the appropriate Qualifying Space Agency who will define a course of action to be followed. No further testing shall be performed on the failed components.

#### 4.3.2 Testing and Lot Acceptance Levels

This specification defines 6 levels of radiation testing (see ESA/SCC Basic Specification No. 22900), 2 levels of testing severity which are designated by the letters 'B' and 'C' (see Chart I) and 3 levels of lot acceptance testing (see Chart V).

The lot acceptance levels are designated 1, 2 and 3 and are comprised of tests as follows:-

Level 3 (LA3) - Electrical Subgroup.

Level 2 (LA2) - Endurance Subgroup  
plus Electrical Subgroup.



Level 1 (LA1) - Environmental and Mechanical Subgroup  
plus Endurance Subgroup  
plus Electrical Subgroup.

The required level of radiation testing, testing level and lot acceptance level shall be specified in a purchase order.

#### 4.4 MARKING

All components procured and delivered to this specification from a source qualified according to ESA/SCC Basic Specification No. 20100 shall be marked in accordance with ESA/SCC Basic Specification No. 21700. Thus, they shall bear the ESA symbol to signify their conformance to the ESA/SCC qualification approval requirements and full compliance with the requirements of this specification and the Detail Specification.

Component procured from sources which are not ESA/SCC qualified, provided that they fully comply with the procurement requirements of this specification and the Detail Specification, may bear the SCC marking **with the exception of the ESA symbol.**

		<p>ESA/SCC Generic Specification No. 3502</p>	<p>PAGE 11 ISSUE 2</p>
---	---	---	----------------------------

#### 4.5 MATERIALS AND FINISHES

All non-metallic materials and finishes, that are not within a hermetically sealed enclosure, of the components specified herein shall meet the outgassing requirements as outlined in ESA PSS-01-702.

Specific requirements for materials and finishes are specified in the Detail Specification.

#### 5. PRODUCTION CONTROL

##### 5.1 GENERAL

The minimum requirements for production control, which are equally applicable to procurement, are defined in the Process Identification Document (P.I.D.).

##### 5.2 SPECIAL IN-PROCESS CONTROLS

###### 5.2.1 Rebonding

The rebonding of wires to the same position is not permitted. Any rebonding procedures must be agreed with the appropriate Q.S.A. and form part of the P.I.D.

###### 5.2.2 Adhesion of Metallisation to Substrate

Components supplied to this specification shall be produced from wafer lots from which a representative sample of one metallised substrate has been subjected to, and successfully met, the requirements of ESA PSS-01-713. The test is to be limited to tape with a peel adhesion strength of 440g/cm. This test is considered destructive.

###### 5.2.3 Verification of Adhesive Strength

A representative sample of the substrate shall be attached to a representative header and subjected to a die shear test in accordance with MIL-STD-883, Test Method 2019. The separation force and category shall be recorded.

###### 5.2.4 Total Dose Irradiation Testing

During qualification and maintenance of qualification:-

If specified in the Detail Specification, components shall be produced from a wafer lot which has been subjected to, and successfully met, the radiation requirements contained in ESA/SCC Basic Specification No. 22900.

During procurement:-

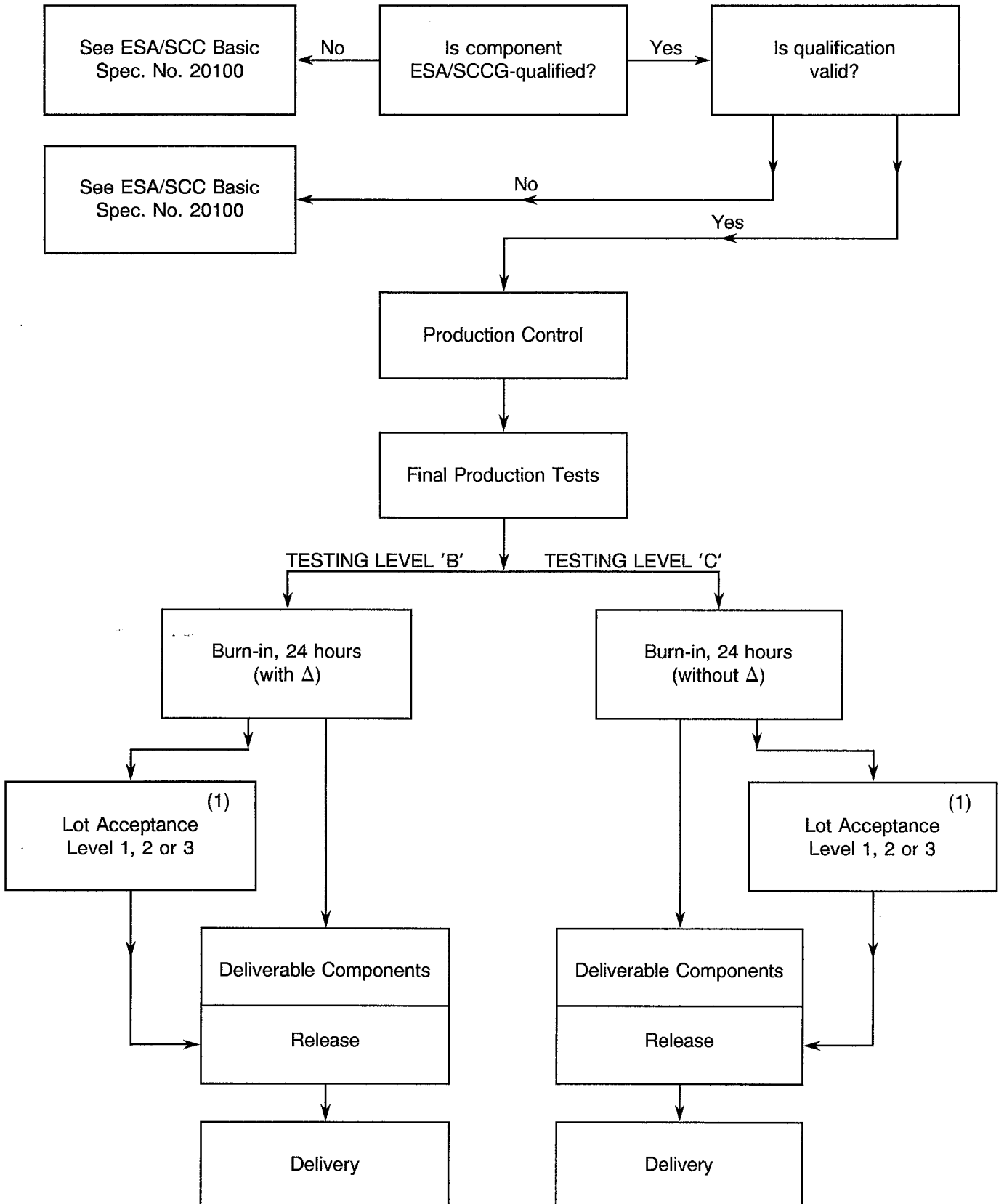
When required by the purchase order, components shall be produced from a wafer lot which has been subjected to and successfully met, the radiation requirements contained in ESA/SCC Basic Specification No. 22900.

###### 5.2.5 Documentation

Documentation of special in-process controls shall be in accordance with the requirements of Para. 10.5 of this specification.




**CHART I - TESTING LEVELS**



**NOTES**

1. When applicable.

	<p style="text-align: center;">ESA/SCC Generic Specification No. 3502</p>	<p>PAGE 13 ISSUE 2</p>
---	---	----------------------------

## 6. FINAL PRODUCTION TESTS

### 6.1 GENERAL

Unless otherwise specified in the Detail Specification, all components used for qualification testing and all components for delivery, including those submitted to lot acceptance tests, shall be subjected to tests and inspections in accordance with Chart II.

Unless otherwise specified in the Detail Specification, the tests shall be performed in the order shown.

Any components that do not meet these requirements shall be removed from the lot and at no future time be re-submitted to the requirements of this specification.

### 6.2 TEST METHODS AND CONDITIONS

The applicable test methods and conditions are specified in the paragraphs referenced in Chart II of this specification.

### 6.3 DOCUMENTATION

Documentation of final production test data shall be in accordance with the requirements of Para. 10.6 of this specification.

## 7. BURN-IN AND ELECTRICAL MEASUREMENTS

### 7.1 GENERAL

Unless otherwise specified in the Detail Specification, all components used for qualification testing and all components for delivery, including those submitted to lot acceptance tests, shall be subjected to tests and inspections in accordance with Chart III.

Unless otherwise specified in the Detail Specification, the tests shall be performed in the order shown.

The applicable test methods and conditions are specified in the paragraphs referenced in Chart III.

Components of testing level 'B' shall be serialised prior to the tests and inspections.

#### 7.1.1 Conditions of Test

The conditions for burn-in shall be as shown in Table 5 of the Detail Specification.

Unless otherwise specified in the Detail Specification, components of levels 'B' and 'C' shall be subjected to a total burn-in of 24 hours.

#### 7.1.2 Data Points

For components of testing level 'B' undergoing a total burn-in period of 24 hours, the data points for parameter drift measurement shall be 0 hours (initial) and 24(+ 24 - 0) hours (final).

For components of testing level 'C' undergoing a total burn-in period of 24 hours, the data point for measurements after testing shall be 24(+ 24 - 0) hours.



## 7.2 FAILURE CRITERIA

### 7.2.1 Parameter Drift Failure

The acceptable delta ( $\Delta$ ) limits are shown in Table 4 of the Detail Specification. A component of testing level 'B' shall be counted as a parameter drift failure if the changes during burn-in are larger than the delta ( $\Delta$ ) values specified.

### 7.2.2 Parameter Limit Failure

A component shall be counted as a limit failure if one or more parameters exceed the limits shown in Tables 2 or 3 of the Detail Specification.

Any component which exhibits a limit failure prior to the burn-in sequence shall be rejected and not counted when determining lot rejection.

### 7.2.3 Other Failures

A component shall be counted as a failure in any of the following cases:

- Mechanical failure.
- Handling failure.
- Lost component.

## 7.3 FAILED COMPONENTS

A component shall be considered as a failed component if it exhibits one or more of the failure modes described in Para. 7.2 of this specification.

## 7.4 LOT FAILURE

In the case of lot failure, the Manufacturer shall act in accordance with the requirements of Para. 4.3.1 of this specification.

### 7.4.1 Lot Failure during 100% Testing

If the number of components, failed on the basis of the failure criteria described in Para. 7.2 is greater than 10% (rounded upwards to the nearest whole number) of the number of components submitted to burn-in and electrical measurements, the lot shall be considered as failed.

If a lot is comprised of groups of components of one family defined in one ESA/SCC Detail Specification, but separately identifiable for any reason, then the lot failure criteria shall apply separately to each identifiable group.

### 7.4.2 Lot Failure during Sample Testing

A lot shall be considered as failed if the number of allowable failures during sample testing in accordance with General Inspection Level II of IEC Publication No. 410 or MIL-STD-105 and the applicable AQL, as specified in the Detail Specification, is exceeded.

In the case where an LTPD is specified in the Detail Specification, a lot shall be considered as failed if the number of failures allowed is exceeded (see Annexe I for LTPD Sampling Plan).

If lot failure occurs in either case, 100% testing may be performed with the lot failure criteria given in Para. 7.4.1.



## 7.5 DOCUMENTATION

Data documentation of burn-in and electrical measurements shall be in accordance with Para. 10.7 of this specification.

## 8. QUALIFICATION APPROVAL AND LOT ACCEPTANCE TESTS

### 8.1 QUALIFICATION TESTING

#### 8.1.1 General

Qualification testing shall be in accordance with the requirements of Chart IV of this specification. The tests to Chart IV shall be performed on the specified sample, chosen at random from components which have successfully passed the tests in Charts II and III for testing level 'B'. This sample constitutes the qualification test lot.

The qualification test lot is divided into subgroups of tests and all components assigned to a subgroup shall be subjected to all of the tests in that subgroup, in the sequence shown.

The applicable test requirements are detailed in the paragraphs referenced in Chart IV.

The conditions governing qualification testing are given in ESA/SCC Basic Specification No. 20100, Para. 5.3 and, for the extension or renewal of a qualification approval, in Paras. 6.3 and 6.4.

#### 8.1.2 Distribution within the Qualification Test Lot

Where a Detail Specification covers a range, or series of components that are considered to be similar, then the qualification test lot shall be comprised of component types, so selected that they adequately represent all of the various mechanical, structural and electrical peculiarities of that range or series.

The selected distribution shall be as specified by, or agreed with, the Qualifying Space Agency.

### 8.2 LOT ACCEPTANCE TESTING

#### 8.2.1 General

The sample sizes of the 3 lot acceptance levels are specified in Chart V. All components assigned to a subgroup shall be subjected to all of the tests of that subgroup in the sequence shown.

The tests to Chart V shall be performed on the specified sample which shall have been chosen, whenever possible, at random from the proposed delivery lot (but see Para. 8.2.3(b)).


The applicable test requirements are detailed in the paragraphs referenced in Chart V.

As a minimum for procurement of non-qualified components, lot acceptance level 3 tests shall apply. For procurement of qualified components, lot acceptance testing shall be performed if specified in a purchase order. Procurement lots ordered with a lot acceptance test level shall be delivered only after successful completion of lot acceptance testing.

#### 8.2.2 Distribution within the Sample for Lot Acceptance Testing

Where a Detail Specification covers a range, or series, of components that are considered similar, then it may be necessary that the sample for lot acceptance testing be comprised of component types so selected that they adequately represent all of the various mechanical, structural and electrical peculiarities of that range or series.

The distribution of the component types will normally vary from procurement to procurement and shall be as specified by the Orderer, following as closely as possible the requirements prescribed in Para. 8.1.2 of this specification.

	<p style="text-align: center;">ESA/SCC Generic Specification No. 3502</p>	<p style="text-align: right;">PAGE 16 ISSUE 2</p>
---	---	---

### 8.2.3 Lot Acceptance Level 3 Testing (LA3)

Lot acceptance level 3 tests are designated as the electrical subgroup and comprise electrical measurements of characteristics and tests to prove the assembly capability of the component.

For LA3 testing, the following requirements and conditions shall apply:-

- (a) LA3 testing shall be performed by the Manufacturer's quality assurance personnel using dedicated quality assurance equipment whenever possible. LA3 testing shall not be a repetition of routine measurements made by production personnel during final production tests and burn-in and electrical measurements.
- (b) When tests to Tables 2 and 3 of the Detail Specification have been performed on a sample basis, then the components for LA3 testing shall be selected from this sample.
- (c) The electrical measurements for LA3 are considered to be non-destructive and therefore components so tested may form part of the delivery lot.
- (d) The solderability and robustness of terminations tests are considered to be destructive and therefore components so tested shall not form part of the delivery lot. Post burn-in electrical rejects may be used for these tests.
- (e) When required in the purchase order, the Manufacturer shall notify the Orderer at least 2 working weeks before the commencement of LA3 testing. The Orderer shall indicate immediately whether or not he intends to witness the tests.

### 8.2.4 Lot Acceptance Level 2 Testing (LA2)

Lot acceptance level 2 testing shall comprise the tests for LA3 (electrical subgroup) plus tests on an endurance subgroup. For the electrical subgroup, the requirements and conditions as for LA3 (see Para. 8.2.3) shall apply.

For the endurance subgroup, the following shall apply:-

- (a) Components of testing level 'C', selected for the endurance subgroup, shall be serialised prior to the tests.
- (b) The tests in this subgroup are considered destructive and therefore components (of testing level 'B' or 'C') so tested shall not form part of the delivery lot.

### 8.2.5 Lot Acceptance Level 1 Testing (LA1)

Lot acceptance level 1 testing shall comprise the tests for LA3 (electrical subgroup) and LA2 (endurance subgroup) plus tests on an environmental and mechanical subgroup. For the electrical and endurance subgroups, the requirements and conditions for LA3 (see Para. 8.2.3) and LA2 (see Para. 8.2.4) respectively shall apply.


For the environmental subgroup, the following shall apply:-

- (a) Components of testing level 'C', selected for the environmental subgroup, shall be serialised prior to the tests.
- (b) The tests in this subgroup are considered destructive and therefore components (of testing level 'B' or 'C') so tested shall not form part of the delivery lot.

## 8.3 FAILURE CRITERIA

The following criteria shall apply to qualification testing and to lot acceptance testing.



	<p style="text-align: center;">ESA/SCC Generic Specification No. 3502</p>		<p>PAGE 17 ISSUE 2</p>
---	---	--	----------------------------

8.3.1 Environmental and Mechanical Test Failures

The following shall be counted as component failures:

- Components which fail during tests for which the pass/fail criteria are inherent in the test method, e.g. seal, solderability, robustness of terminations, etc.

8.3.2 Electrical Failures

The following shall be counted as component failures:-

- (a) Components which, when subjected to electrical measurement on completion of environmental tests, in accordance with either Table 2 or Table 6, as specified in the Detail Specification, fail one or more of the applicable limits.
- (b) Components which, when subjected to electrical measurements at intermediate and end points during endurance testing, in accordance with Table 6 of the Detail Specification, fail one or more of the applicable limits.
- (c) Components which, when subjected to measurement of electrical characteristics, in accordance with Tables 2 and 3 of the Detail Specification, fail one or more of the applicable limits.

8.3.3 Other Failures

The following additional failures may also occur during qualification testing or lot acceptance testing:-

- (a) Components failing to comply with the requirements of ESA/SCC Basic Specification No. 20500.
- (b) Lost components.

8.4 FAILED COMPONENTS

A component shall be considered as failed if it exhibits one or more of the failure modes detailed in Para. 8.3 of this specification.

The allowable number of failed components per subgroup, the aggregate failure constraints and the permitted distribution of such failures are shown at the foot of Charts IV and V of this specification.

When requested by the Qualifying Space Agency or the Orderer, failure analysis of failed components shall be performed by the Manufacturer and the results provided.

Failed components from successful lots shall be marked as such and be stored at the Manufacturer's plant for 24 months.

8.5 LOT FAILURE

A lot shall be considered as failed if the allowable number of failures according to Chart IV or V of this specification, as relevant, has been exceeded.

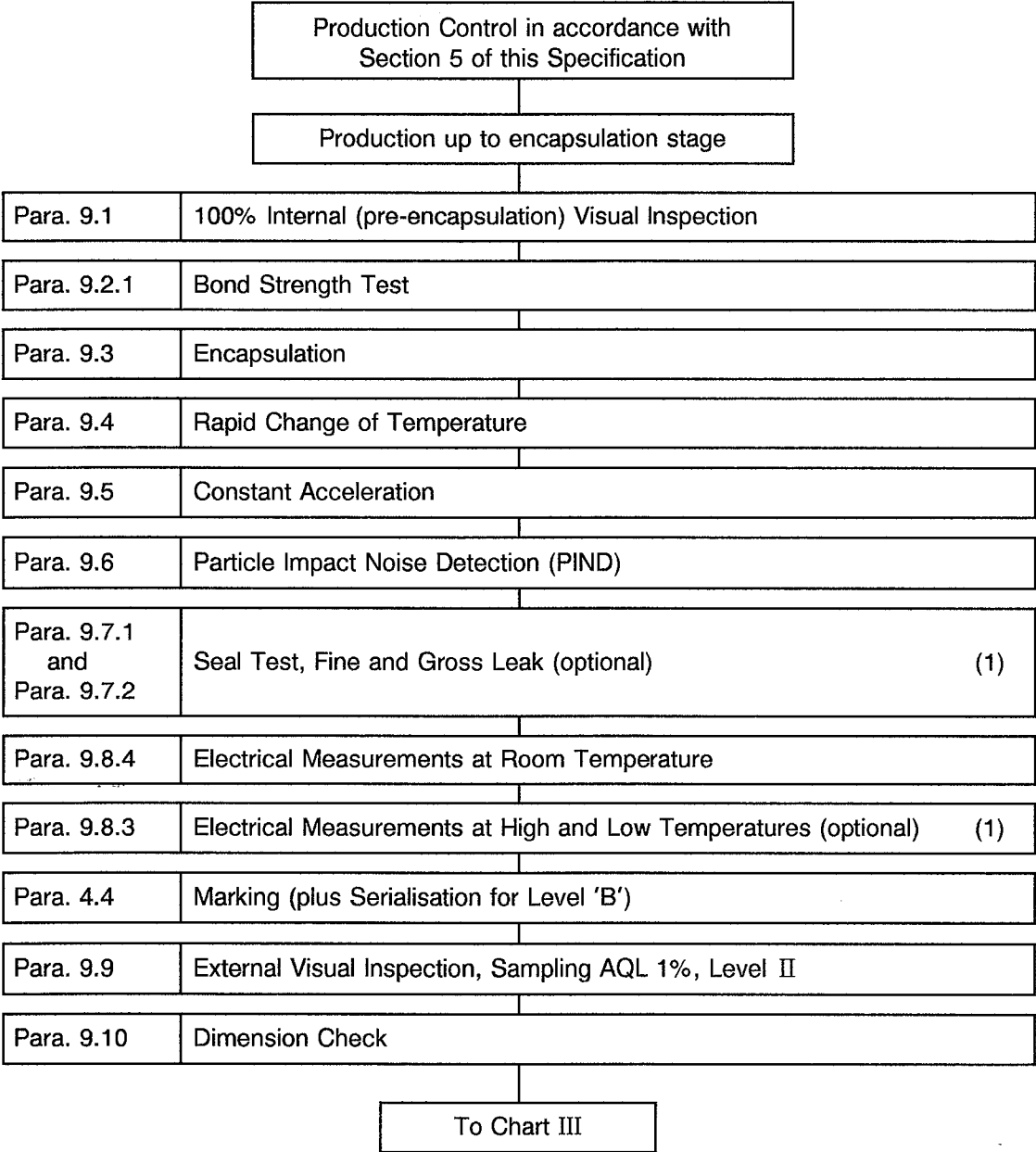
In the case of lot failure, the Manufacturer shall act in accordance with Para. 4.3.1 of this specification.

8.6 DOCUMENTATION

For qualification testing, the qualification test data shall be documented in accordance with the requirements of Para. 10.8 of this specification.

In the case of lot acceptance testing, the data shall be documented in accordance with the requirements of Para. 10.9 of this specification.

**CHART II - FINAL PRODUCTION TESTS**

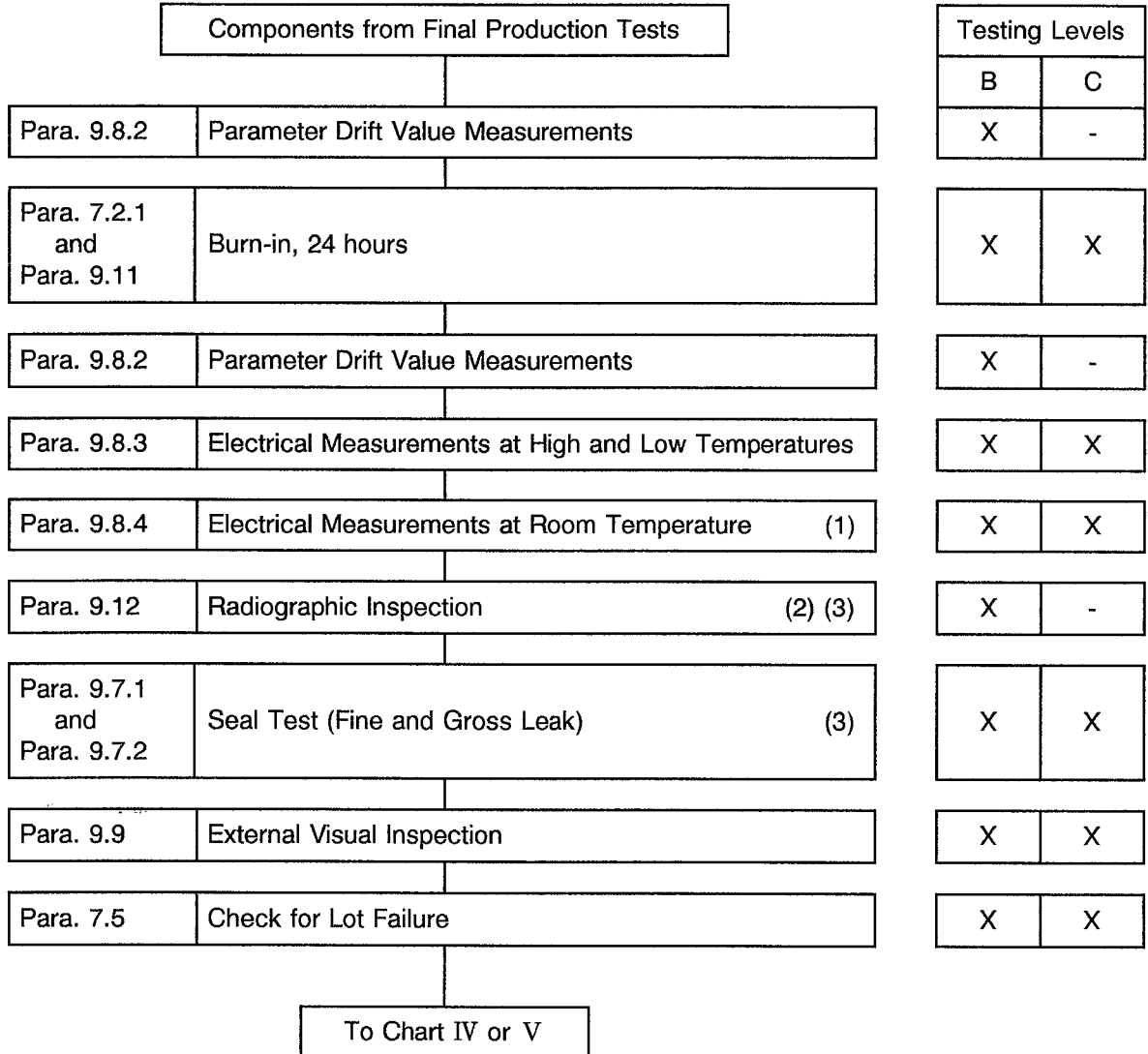


**NOTES**

1. The performance of these tests is left to the Manufacturer's discretion.



**CHART III - BURN-IN AND ELECTRICAL MEASUREMENTS**

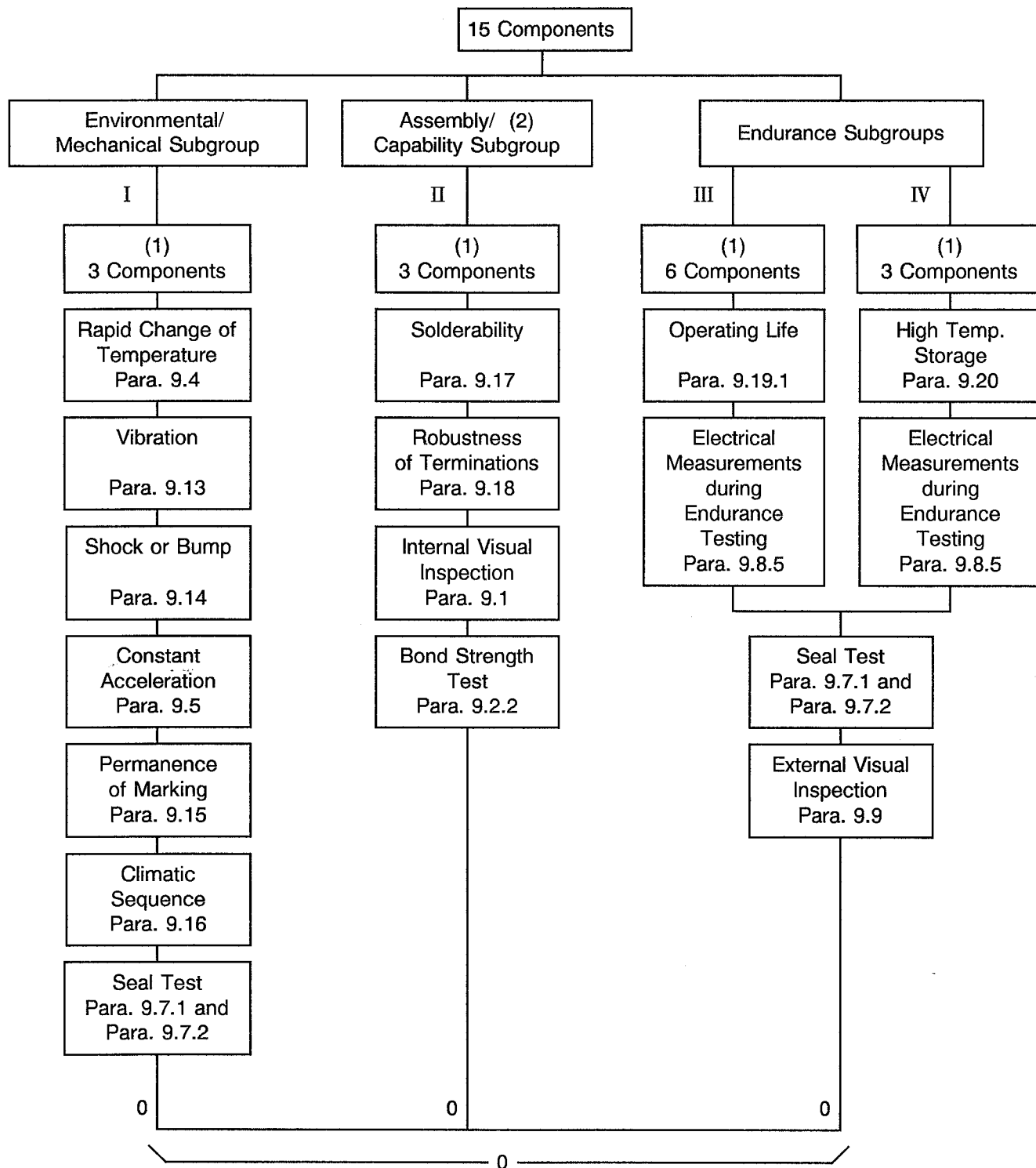


**NOTES**

1. The measurement of parameters for the calculation of Drift Value need not be repeated for Electrical Measurements at Room Temperature.
2. Radiographic Inspection may be performed at any point during the test sequence shown in this Chart.
3. Radiographic Inspection and Seal Test rejects are not to be counted for lot failure.



**CHART IV - QUALIFICATION TESTS**



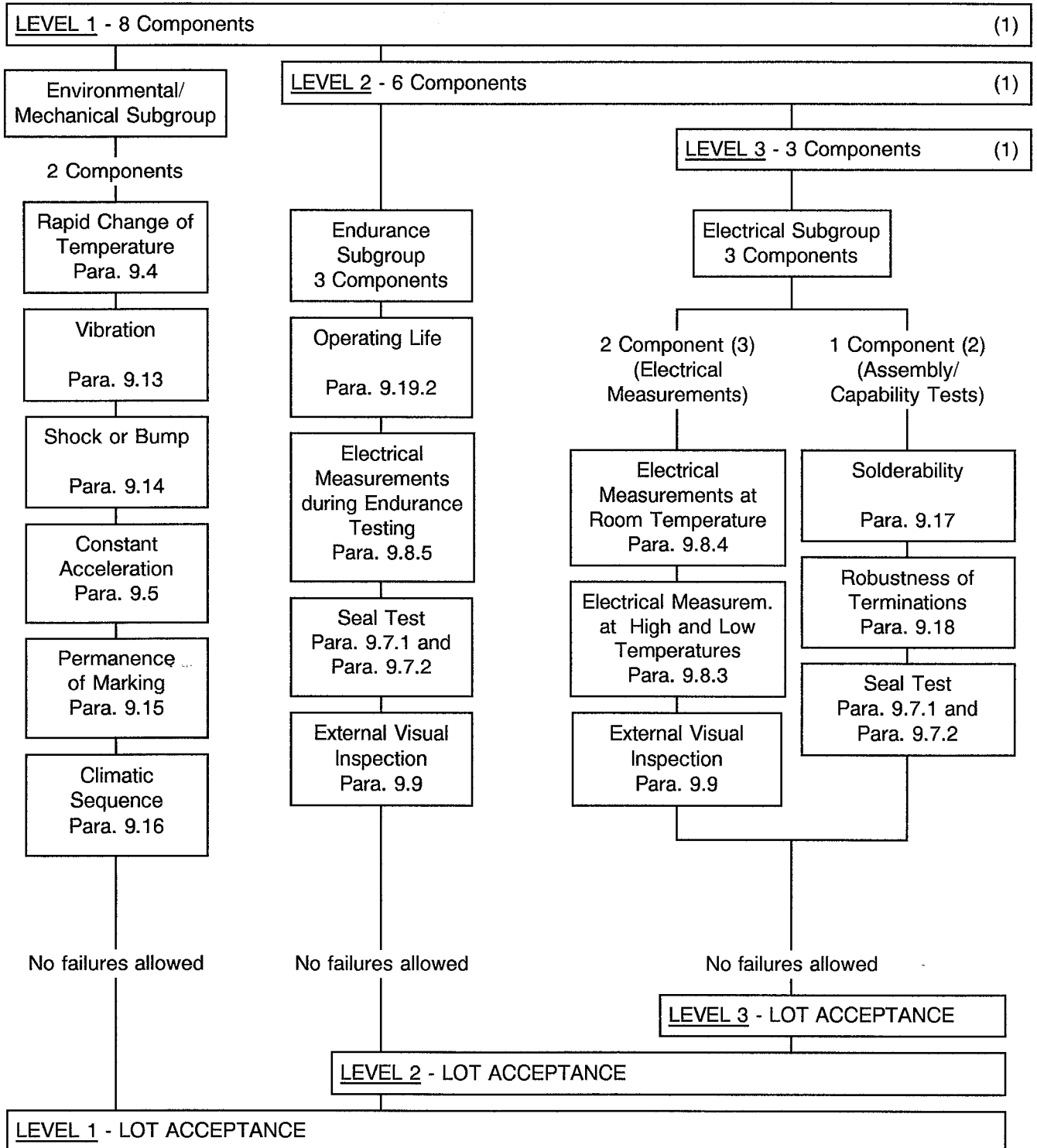
Total allowable number of failed components: 0.

**NOTES**

1. For distribution within the subgroups, see Para. 8.1.2.
2. Post burn-in electrical rejects may be used for these tests.




**CHART V - LOT ACCEPTANCE TESTS**



**NOTES**

1. For distribution within the sample, see Para. 8.2.2.
2. Post burn-in electrical rejects may be used for these tests.
3. The tests in this subgroup are considered to be non-destructive and therefore components so tested shall form part of the delivery lot.

	<p>ESA/SCC Generic Specification No. 3502</p>	<p>PAGE 22 ISSUE 2</p>
---	---	----------------------------

**9. TEST METHODS AND PROCEDURES**

If a Manufacturer elects to eliminate or modify a test method or procedure, the Manufacturer is still responsible for delivering components that meet all of the performance, quality and reliability requirements defined in this specification and the Detail Specification.

Documentation supporting the change shall be approved by the Qualifying Space Agency and retained by the Manufacturer. It shall be copied, when requested, to the Qualifying Space Agency.

The change shall be specified in the Detail Specification and in the P.I.D.

9.1 **INTERNAL VISUAL INSPECTION**

In accordance with ESA/SCC Basic Specification No. 20400.

9.2 **BOND STRENGTH TEST**

**N.B.** This test is destructive.

9.2.1 **Bond Strength Test during Final Production Tests**

(a) **Test Conditions**

IEC Publication No. 749, Test Method A or B.

(b) **Test Procedure**

Select 1 of the components at random from the lot accepted after internal (pre-encapsulation) visual inspection.

Test all bonds.

(c) **Accept/Reject Criteria**

- Individual separation forces and categories shall be recorded. A single failure shall be cause for rejection of the lot.

9.2.2 **Bond Strength Test during Qualification Testing**

(a) **Test Conditions**

As per Para. 9.2.1(a).

(b) **Test Procedure**

As per Para. 9.2.1(b), but the component shall be selected from those in Subgroup II of Chart IV.

(c) **Accept/Reject Criteria**

As per Para. 9.2.1(c).

9.3 **ENCAPSULATION**

In accordance with the Process Identification Document (P.I.D.).



9.4 **RAPID CHANGE OF TEMPERATURE**

9.4.1 **General**

The components shall be subjected to Test 'Na' of IEC Publication No. 68-2-14.

**During Chart II**

The number of cycles shall be 10 with 30 minutes at each operating temperature extreme as specified in the Detail Specification.

		<p>ESA/SCC Generic Specification No. 3502</p>	<p>PAGE 23 ISSUE 2</p>
---	---	---	----------------------------

#### During Chart IV or V

The number of cycles shall be 10 with 30 minutes at each storage temperature extreme as specified in the Detail Specification. After a recovery period of  $24 \pm 2$  hours at room temperature, electrical measurements as specified in Table 6 of the Detail Specification shall be performed and shall not exceed the specified limits.

#### 9.4.2 Final Examination

The components shall be visually examined. There shall be no evidence of damage.

#### 9.5 CONSTANT ACCELERATION

##### 9.5.1 Mounting

The specimens shall be fixed to the acceleration machine, either directly or by means of a fixture as specified below. Mounting fixtures shall enable the specimens to be subjected to acceleration along the 3 mutually perpendicular axes in turn. When the component is provided with specified mounting means, these shall be used as specified in the Detail Specification and any additional restraining straps should be avoided.

Unless otherwise specified in the Detail Specification, components not provided with specific mounting means shall be clamped by the body. When external connections, necessary for measuring and supply purposes are specified in the Detail Specification, they should add the minimum restraint and weight.

##### 9.5.2 Procedure

The components shall be subjected to Test 'Ga' of IEC Publication No. 68-2-7. Acceleration rate:  $49000\text{m/s}^2$  (5000g). The test shall be performed for 3 minutes in both directions of the 3 perpendicular axes of the test specimen, so that the acceleration is applied for a total period of approximately 18 minutes.

##### 9.5.3 Final Measurements during Charts IV and V

After acceleration, electrical measurements as specified in Table 6 of the Detail Specification shall be performed and shall not exceed the specified limits.

##### 9.5.4 Final Examination

The components shall be visually examined. There shall be no evidence of damage.

#### 9.6 PARTICLE IMPACT NOISE DETECTION (PIND)



MIL-STD-883, Test Method 2020, Test Condition 'B'.

PIND Pre-screening shall not be performed.

The devices shall be submitted to PIND testing a maximum of 5 times and after each test run, defective devices shall be removed from the lot.

The lot may be accepted on any of the 5 runs if the percentage of defective devices is less than 1% (or 1, whichever is greater) of the devices tested.

Lots, which on the 5th run do not meet 1% PDA or which at any time exceed 25% cumulative, shall be rejected.

 	<p style="text-align: center;">ESA/SCC Generic Specification No. 3502</p>		<p>PAGE 24 ISSUE 2</p>
---	---	--	----------------------------

## 9.7 SEAL TEST

### 9.7.1 Fine Leak

The components shall be subjected to Test 'Qk' of IEC Publication No. 68-2-17, Method 1, Severity 1000h. Prior to the test the units shall be carefully cleaned. Unless otherwise specified in the Detail Specification, immersion pressure shall not exceed 4 bars.

### 9.7.2 Gross Leak

Unless otherwise specified in the Detail Specification, the components shall be immersed in a pressure vessel containing helium at a pressure of 5 atmospheres for a period of 1 hour.

Unless otherwise specified in the Detail Specification, pressurisation shall be followed by Test 'Qc', Method 1 of IEC Publication No. 68-2-17 using distilled water with a wetting agent. The duration of the immersion shall be 4 to 5 minutes at ambient room temperature. There shall be no evidence of leakage.

## 9.8 ELECTRICAL MEASUREMENTS

### 9.8.1 Electrical Test Methods

#### 9.8.1.1 General

All equipment shall have the same characteristic impedance. Where a parameter is specified over a frequency range a plot of that parameter, over the specified swept frequency range, shall be produced.

#### 9.8.1.2 Insertion Loss, In-Band Ripple and Out-Of-Band Rejection

Using the test set-up in Figure I, the device under test (D.U.T.) is replaced by a through connection. A reference level INPUT/REF=0dB is established over the required frequency range. The D.U.T. is inserted and the new power ratio INPUT/REF (in dB) is measured over the required frequency range. The frequency range of the source and the sensitivity of the network analyser are adjusted to resolve the parameters, as shown on the typical plots (Figures II and III).

#### 9.8.1.3 Phase Linearity

Using the test set-up in Figure I, the absolute phase shift of the D.U.T. is obtained as follows.

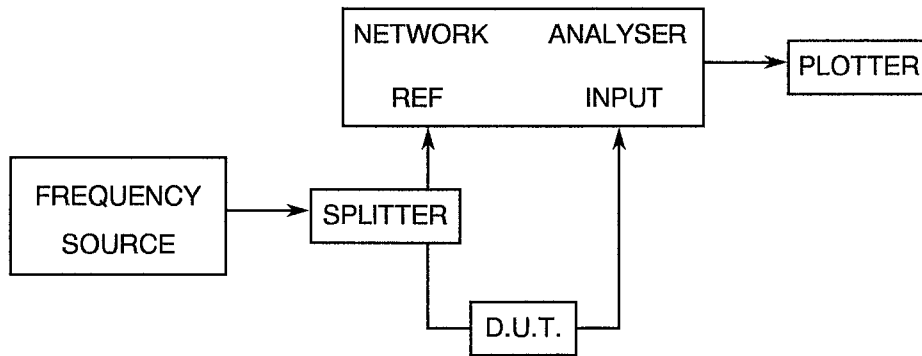
With a through connection in place of the D.U.T., a reference phase shift at each frequency is obtained, (some equipments allow electronic compensation for the extra electrical length of the measurement arm to give a 0° reference over the band). The D.U.T. is connected and the phase difference between signals at INPUT/REF is the phase shift. In general, for SAW devices, the phase shift will vary almost linearly with frequency and only the deviation from linearity is of interest. This parameter can be derived by subtraction of the linear component (which may be achieved electronically in some equipments). A typical plot is shown in Figure IV.

#### 9.8.1.4 Group Delay and Group Delay Ripple

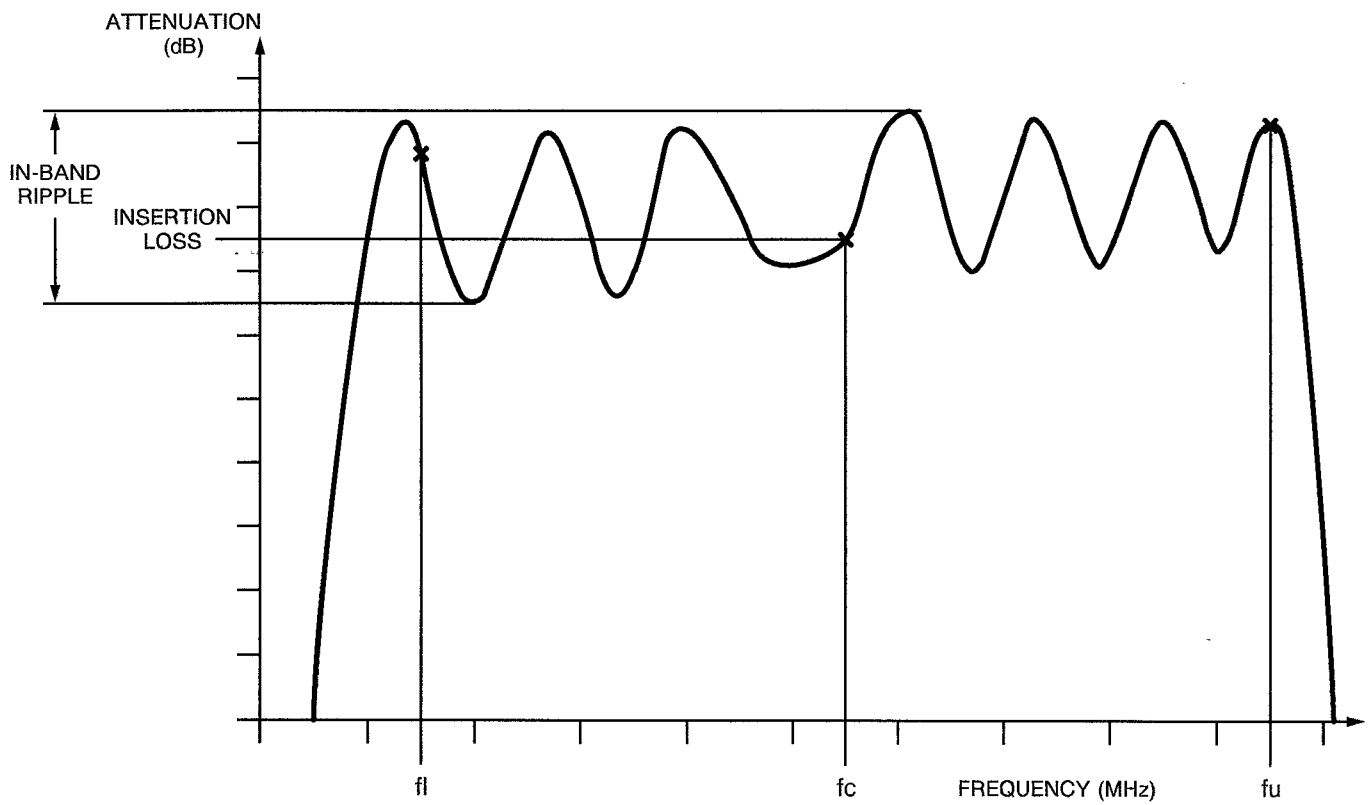
The group delay of the D.U.T. may be obtained directly from the rate of change of phase shift with frequency. (Some equipments allow direct measurement of this parameter after zeroing with a through connection).



**FIGURE I - INSERTION LOSS, IN-BAND RIPPLE, OUT-OF-BAND REJECTION AND PHASE LINEARITY TEST SET-UP**

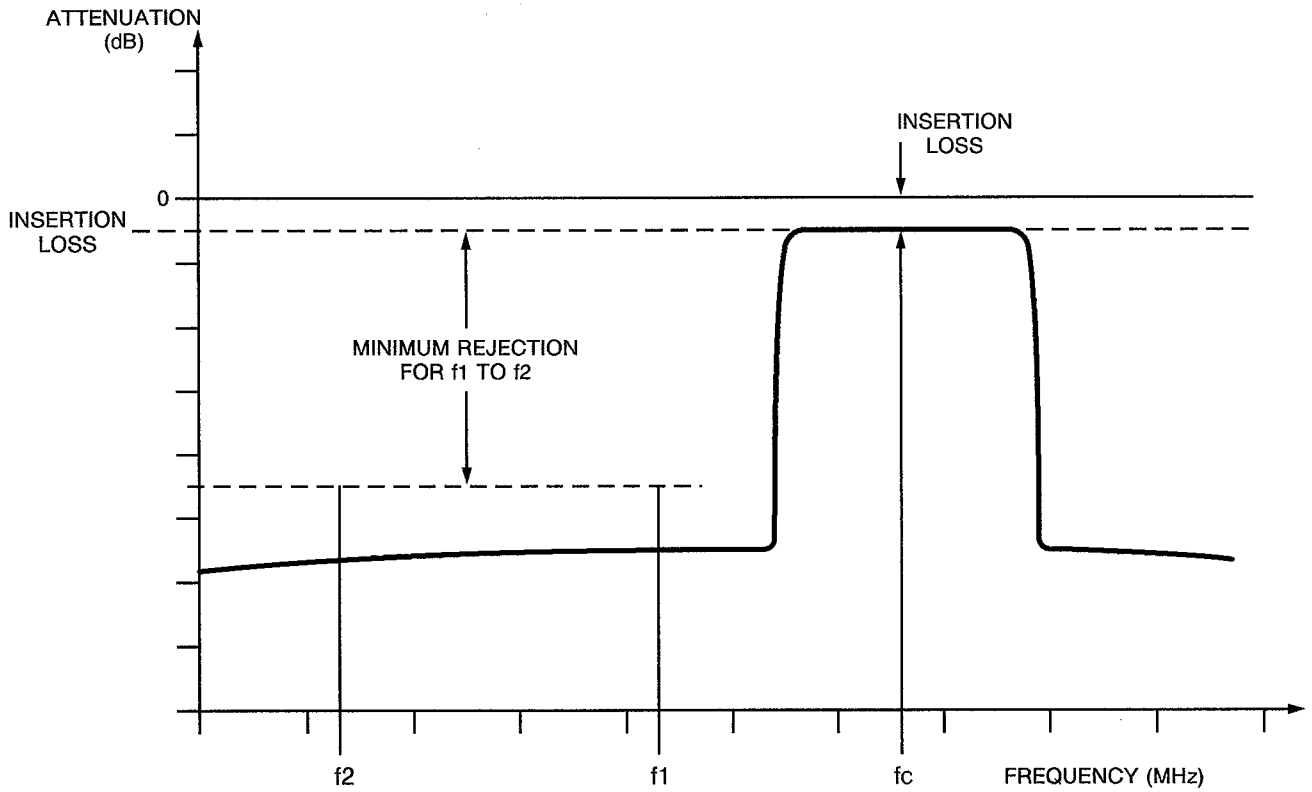


**FIGURE II - INSERTION LOSS AND IN-BAND RIPPLE, TYPICAL PLOT**

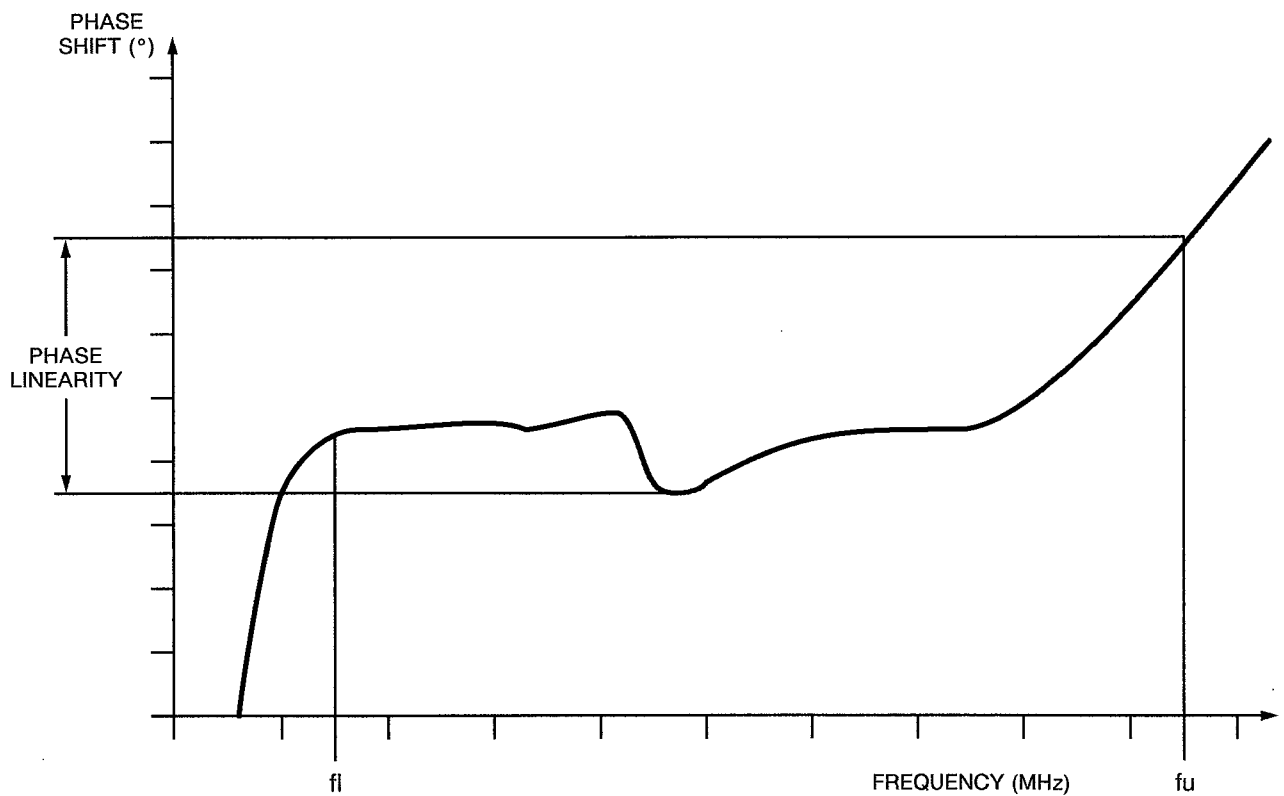




**FIGURE III - OUT-OF-BAND REJECTION, TYPICAL PLOT**



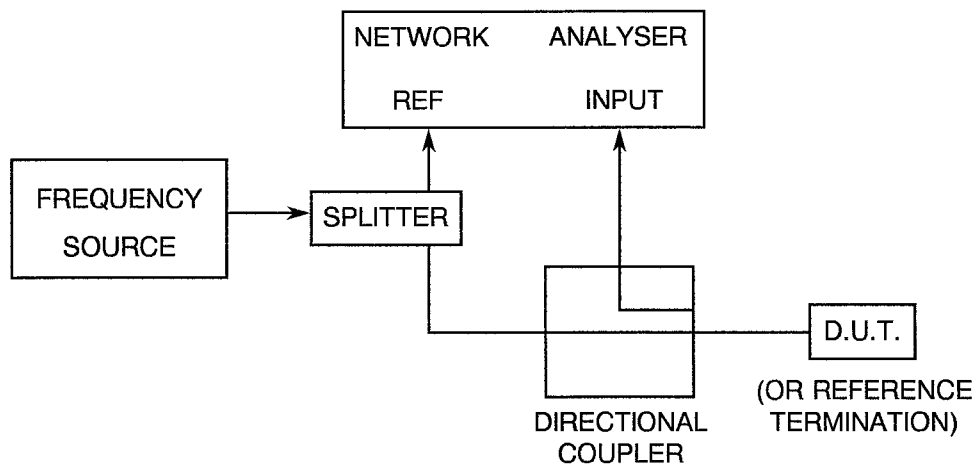
**FIGURE IV - PHASE LINEARITY, TYPICAL PLOT**



### 9.8.1.5 Return Loss

Using the test set-up in Figure V, a reference termination, (short or open circuit), is connected to the Directional Coupler as shown and a reference level INPUT/REF = 0dB is established at the required frequency. The D.U.T. is inserted and the new INPUT/REF (in dB) is measured. This is the return loss of the port of the D.U.T. in question. The return loss of the other port is obtained in a similar way.

**FIGURE V - RETURN LOSS TEST SET-UP**



### 9.8.2 Parameter Drift Value Measurements

At each of the relevant data points for components of testing level 'B', measurements shall be made of all parameters listed in Table 4 of the Detail Specification. All values obtained shall be recorded against serial numbers and the parameter drift calculated.

### 9.8.3 Electrical Measurements at High and Low Temperatures

For components of testing levels 'B' and 'C', the electrical measurements at high and low temperatures shall be made in accordance with Table 3 of the Detail Specification. Where sample testing is applied, note the requirements of Para. 8.2.3(b). For testing level 'B', all values shall be recorded against serial numbers.

### 9.8.4 Electrical measurements at Room Temperature


For components of testing levels 'B' and 'C', the measurements of electrical characteristics shall be made in accordance with Table 2 of the Detail Specification. Where sample testing is applied, note the requirements of Para. 8.2.3(b). For testing level 'B', all values shall be recorded against serial numbers, except during Final Production Tests (Chart II).

### 9.8.5 Electrical Measurements during Endurance Testing

At each of the relevant data points specified for endurance testing, measurements shall be made of the parameters listed in Table 6 of the Detail Specification. All values obtained shall be recorded against serial numbers and the parameter drift calculated, if required.

### 9.9 EXTERNAL VISUAL INSPECTION

In accordance with ESA/SCC Basic Specification No. 20500.

	<p style="text-align: center;">ESA/SCC Generic Specification No. 3502</p>	<p>PAGE 28 ISSUE 2</p>
---	---	----------------------------

9.10 DIMENSION CHECK

In accordance with ESA/SCC Basic Specification No. 20500 and the Detail Specification. To be performed on 5 samples only.

If a failure occurs, the complete lot shall be checked.

9.11 BURN-IN

Test conditions as specified in the Detail Specification.

9.12 RADIOGRAPHIC INSPECTION

In accordance with ESA/SCC Basic Specification No. 20900.

9.13 VIBRATION

(a) **Mounting**

As per Para. 9.5.1, the word 'acceleration' to be replaced by 'vibration'.

(b) **Procedure**

The components shall be subjected to Test 'Fc' of IEC Publication No. 68-2-6. Sweep frequency: 10-2000-10Hz. The entire frequency range of 10 to 2000Hz and return to 10Hz shall be traversed in 10 minutes. This cycle shall be performed 12 times in each of the 3 directions (i.e. 36 times in total), so that the motion is applied for a total period of approximately 6 hours. The vibration amplitude shall be 1.5mm from 10Hz to the higher cross-over frequency and then 20g acceleration to 2000Hz.

(c) **Final Measurements**

As per Para. 9.5.3, the word 'acceleration' to be replaced by 'vibration'.

(d) **Final Examination**

The components shall be visually examined. There shall be no evidence of damage.

9.14 SHOCK OR BUMP

9.14.1 Shock

(a) **Mounting**

As per Para. 9.5.1, the word 'acceleration' to be replaced by 'shock'.

(b) **Procedure**

The components shall be subjected to Test 'Ea' of IEC Publication No. 68-2-27: Unless otherwise specified in the Detail Specification, the following conditions shall apply:


- Shape of shock pulse: Half sine.
- Peak acceleration: 50g.
- Duration of pulse: 11ms.
- Number of shocks: 18 (3 shocks in each direction along the 3 perpendicular axes of the specimen).

(c) **Final Measurements**

As per Para. 9.5.3, the word 'acceleration' to be replaced by 'shock'.

(d) **Final Examination**

The components shall be visually examined. There shall be no evidence of damage.

	<p style="text-align: center;">ESA/SCC Generic Specification No. 3502</p>		<p>PAGE 29 ISSUE 2</p>
---	---	--	----------------------------

9.14.2 Bump

(a) **Mounting**

As per Para. 9.5.1, the word 'acceleration' to be replaced by 'bump'.

(b) **Procedure**

The components shall be subjected to Test 'Eb' of IEC Publication No. 68-2-29. Unless otherwise specified in the Detail Specification, the following conditions shall apply:

- Peak acceleration: 390m/s<sup>2</sup>.
- Duration of pulse: 6ms.
- Number of bumps: 4000 ± 10.

(c) **Final Measurements**

As per Para. 9.5.3, the word 'acceleration' to be replaced by 'bump'.

(d) **Final Examination**

The components shall be visually examined. There shall be no evidence of damage.

9.15 PERMANENCE OF MARKING

In accordance with ESA/SCC Basic Specification No. 24800.

9.16 CLIMATIC SEQUENCE

9.16.1 Initial Measurements

No initial measurements are required.

9.16.2 Dry Heat

The components shall be subjected to Test 'Ba' of IEC Publication No. 68-2-2. Duration: 2 hours. Maximum operating temperature as prescribed in the Detail Specification.

While still at the specified high temperature and at the end of the period of high temperature, electrical measurements as specified in Table 3 of the Detail Specification shall be performed and shall not exceed the specified limits.


9.16.3 Damp Heat, Accelerated, First Cycle

Unless otherwise specified in the Detail Specification and after a recovery period of 1 to 24 hours, the components shall be subjected to Test 'Db', Severity b, Variant 2 of IEC Publication No. 68-2-30 for 1 cycle of 24 hours. After a recovery period of 1 to 24 hours, the components shall be subjected immediately to the cold test.

9.16.4 Cold Test

The components shall be subjected to Test 'Aa' of IEC Publication No. 68-2-1. Duration: 2 hours. Minimum operating temperature as prescribed in the Detail Specification.

While still at the specified low temperature and at the end of the period of low temperature, electrical measurements as specified in Table 3 of the Detail Specification shall be performed and shall not exceed the specified limits.

	<p style="text-align: center;">ESA/SCC Generic Specification No. 3502</p>	<p style="text-align: right;">PAGE 30 ISSUE 2</p>
---	---	---

9.16.5 Damp Heat, Accelerated, Remaining Cycles

The components shall be subjected to Test 'Db', Severity b, Variant 2 of IEC Publication No. 68-2-30 for 5 cycles of 24 hours.

9.16.6 Recovery and Final Inspection

After a recovery period of 1 to 24 hours, the components shall be visually inspected. There shall be no evidence of damage.

9.16.7 Final Measurements

The measurements specified in Table 6 of the Detail Specification shall be performed and shall not exceed the specified limits.

9.17 SOLDERABILITY

The components shall be subjected to Test 'Ta', Method 1 of IEC Publication No. 68-2-20.

9.18 ROBUSTNESS OF TERMINATIONS

All terminals of the components shall be subjected to Test 'Ua<sub>1</sub>' of IEC Publication No. 68-2-21.

9.19 OPERATING LIFE

9.19.1 Operating Life during Qualification Testing (Chart IV)

Duration: 2000 hours.

Test Conditions: As specified in the Detail Specification.

Data Points: Measurements at intermediate and end-points according to Table 6 of the Detail Specification at 0, 1000 ± 48 hours and 2000 ± 48 hours.

In the case where Table 6 specifies "changes", the drift shall always be related to the 0-hour measurement.

9.19.2 Operating Life during Lot Acceptance Testing (Chart V)

Duration: 1000 hours.

Test Conditions: As specified in the Detail Specification.

Data Points: Measurements at 0 hours and 1000 ± 48 hours according to Table 6 of the Detail Specification.

In the case where Table 6 specifies "changes", the drift shall always be related to the 0-hour measurement.



9.20 HIGH TEMPERATURE STORAGE

Duration: 2000 hours.

Test Conditions: Maximum storage temperature as specified in the Detail Specification.

Data Points: Measurements at intermediate and end-points according to Table 6 of the Detail Specification at 0, 1000 ± 48 hours and 2000 ± 48 hours.

In the case where Table 6 specifies "changes", the drift shall always be related to the 0-hour measurement.

		<p style="text-align: center;">ESA/SCC Generic Specification No. 3502</p>	<p style="text-align: center;">Rev. 'A'</p>	<p>PAGE 31 ISSUE 2</p>
---	---	---	---	----------------------------

## 10. DATA DOCUMENTATION

### 10.1 GENERAL

For the qualification approval records and with each component delivery, a data documentation package is required. Depending on the testing level and lot acceptance level specified for the component, this package shall be compiled from:-

- (a) Cover sheet (or sheets).
- (b) List of equipment (testing and measuring).
- (c) List of test references.
- (d) Special in-process control test data.
- (e) Final production test data (Chart II) (but see Para. 10.6).
- (f) Burn-in and electrical measurement data (Chart III).
- (g) Qualification test data (Chart IV).
- (h) Lot acceptance test data (Chart V) (when applicable).
- (i) Failed components list (see Paras. 7.3 and 8.4) and failure analysis report (see Para. 8.4).
- (j) Certificate of Conformity.
- (k) Radiographic inspection photographs.

Items (a) to (k) inclusive shall be grouped, preferably as subpackages and, for identification purposes, each page shall include the following information:

- ESA/SCC Component Number.
- Manufacturer's name.
- Lot identification.
- Date of establishment of the document.
- Page number.

#### 10.1.1 Qualification Approval



In the case of qualification approval, the items listed in Para. 10.1 (a) to (k) less item (h) are required.

#### 10.1.2 Testing Level 'B'

##### 10.1.2.1 Qualified Components

For deliveries of qualified components, the following documentation shall be supplied:-

- (a) Cover sheet (if all of the information is not included on the Certificate of Conformity).
- (b) Certificate of Conformity (including range of delivered serial numbers).
- (c) Attributes record of measurements, tests and inspections performed in Chart II, Chart III (including PDA figure) and Chart V (where applicable).
- (d) Failed components list.

		<p style="text-align: center;">ESA/SCC Generic Specification No. 3502</p>	<p style="text-align: center;">Rev. 'A'</p>	<p>PAGE 32 ISSUE 2</p>
---	---	---	---	----------------------------

#### 10.1.2.2 Unqualified Components

For deliveries of unqualified components, the documentation to be supplied shall be in accordance with Para. 10.1.2.1 plus the following:-

- (a) Read and record data from Chart III.
- (b) Special in-process control data (where applicable).
- (c) Failure analysis report on failed components.

#### 10.1.3 Testing Level 'C'

##### 10.1.3.1 Qualified Components

For deliveries of qualified components, the following documentation shall be supplied:-

- (a) Certificate of Conformity.

##### 10.1.3.2 Unqualified Components

For deliveries of unqualified components, the documentation to be supplied shall be in accordance with Para. 10.1.3.1 plus the following:-

- (a) Cover sheet (if all of the information is not included on the Certificate of Conformity).
- (b) Attributes record of all measurements, tests and inspections performed in Charts II, III and V (when applicable).
- (c) Failed components list (including Failure Analysis Report).
- (d) Special in-process control data (when applicable).

#### 10.1.4 Data Retention/Data Access


If not delivered, all data shall be retained by the Manufacturer for a minimum of 5 years during which time it shall be available to the Qualifying Space Agency and the Orderer, if requested, for review. The Manufacturer shall deliver variables Data/Reports to the Orderer if required by the Purchase Order.

#### 10.2 COVER SHEET(S)

The cover sheet(s) of the data documentation package shall include as a minimum:-

- (a) Reference to the Detail Specification, including issue and date.
- (b) Reference to the Generic Specification, including issue and date.
- (c) Component type and number.
- (d) Lot identification.
- (e) Range of delivered serial numbers (for components of testing level 'B').
- (f) Number of purchase order.
- (g) Information relative to any additions to this specification and/or the Detail Specification.
- (h) Manufacturer's name and address.
- (i) Location of the manufacturing plant.
- (j) Signature on behalf of the Manufacturer.
- (k) Total number of pages of the data package.



	<p style="text-align: center;">ESA/SCC Generic Specification No. 3502</p>	<p style="text-align: right;">PAGE 33 ISSUE 2</p>
---	---	---

10.3 LIST OF EQUIPMENT USED

A list of equipment used for tests and measurements shall be prepared, if not in accordance with the data given in the Process Identification Document (P.I.D.). Where applicable, this list shall contain inventory number, Manufacturer's type number, serial number, etc. This list shall indicate for which tests such equipment was used.

10.4 LIST OF TEST REFERENCES

This list shall include all Manufacturer's references or codes which are necessary to correlate the test data provided with the applicable tests specified in the tables of the Detail Specification.

10.5 SPECIAL IN-PROCESS CONTROL DATA

Data of Metallisation Adhesion testing shall be provided in accordance with the requirements of ESA PSS-01-713.

Results of the die shear test shall be provided.

A radiation test report shall be provided in accordance with the requirements of ESA/SCC Basic Specification No. 22900 (if required).

10.6 FINAL PRODUCTION TEST DATA (CHART II)

A test result summary shall be compiled showing the total number of components submitted to, and the total number rejected after, each of the following tests:

- Pre-encapsulation internal visual inspection (Para. 9.1).
- Bond strength test (Para. 9.2).
- Environmental tests (Paras. 9.4, 9.5 and 9.6).
- Seal test (fine and gross leak) (Para. 9.7).
- Electrical measurements at room temperature (Para. 9.8.4).
- Electrical measurements at high and low temperatures (Para. 9.8.3), (when applicable).
- External visual inspection (Para. 9.9).
- Dimension check (Para. 9.10).

For the bond strength test, the separation forces and categories shall be recorded.


The final production test data shall form an integral part of the data documentation package, but it is not a mandatory requirement that it be delivered with the qualification lot or delivery lot. However, the data package to be delivered shall contain the information as detailed in Paras. 10.1.2 and 10.1.3 or at least shall contain a list of final production tests actually performed and a certification that the data is available for review.

10.7 BURN-IN AND ELECTRICAL MEASUREMENT DATA (CHART III)

10.7.1 Testing Level 'B'

For components of testing level 'B' all data shall refer to the relevant serial numbers. Against these serial numbers, data shall be recorded of the following:-

- (a) 0 hour measurement for burn-in.
- (b) 24 hour measurement for burn-in.
- (c) Delta ( $\Delta$ ) values after burn-in.
- (d) Values and plots obtained during electrical measurements at high and low temperatures (Table 3 of the Detail Specification).

	<p style="text-align: center;">ESA/SCC Generic Specification No. 3502</p>	<p style="text-align: right;">PAGE 34 ISSUE 2</p>
---	---	---

- (e) Values and plots obtained during electrical measurements at room temperature (Table 2 of the Detail Specification).
- (f) Failures during seal test.
- (g) Failures during external visual inspection.
- (h) Photographs from radiographic inspection, including those of reject components.

#### 10.7.2 Testing Level 'C'

For components of testing level 'C' a test result summary (i.e. the total number of components subjected to, and the total number rejected from, each of the tests and inspections) shall be prepared.

#### 10.8 QUALIFICATION TEST DATA (CHART IV)

All data shall be referenced to the relevant serial numbers. Detailed records shall be provided of the components submitted to each test in each of the subgroups and of those rejected.

Detailed data (including plots) shall be provided of all electrical measurements made in accordance with Tables 2, 3 and 6 of the Detail Specification, as and where applicable.

#### 10.9 LOT ACCEPTANCE TEST DATA (CHART V)

##### 10.9.1 Testing Level 'B'

All data shall be referenced to the relevant serial numbers. Detailed records shall be provided of the components submitted to each test in each of the subgroups (as relevant to the lot acceptance level) and of those rejected.

Detailed data (including plots) shall be provided of all electrical measurements made in accordance with Tables 2, 3 and 6 of the Detail Specification, as and where applicable.

##### 10.9.2 Testing Level 'C'

A test result summary (i.e. the total number of components submitted to, and the total number of components rejected from, each of the tests and inspections) as relevant to the lot acceptance level, shall be provided.


In the case of lot acceptance 2 testing, all data (and plots) in respect of electrical measurements made in accordance with Table 6 of the Detail Specification shall be referenced to the relevant serial numbers (see Para. 8.2.4(a)).

In the case of lot acceptance 1 testing, all data (and plots) in respect of electrical measurements made in accordance with Tables 2 and 6 of the Detail Specification shall be referenced to the relevant serial numbers (see Para. 8.2.5(a)).

#### 10.10 FAILED COMPONENTS LIST AND FAILURE ANALYSIS REPORT

The failed component list and failure analysis report shall provide full details of:-

- (a) The reference number and description of the test or measurement performed as defined in this specification and/or the Detail Specification.
- (b) The serial number (if applicable) of the failed component.
- (c) The failed parameter and the failure mode of the components.
- (d) Detailed failure analysis, if requested.

	<p style="text-align: center;">ESA/SCC Generic Specification No. 3502</p>	<p>PAGE 35 ISSUE 2</p>
---	---	----------------------------

10.11 **CERTIFICATE OF CONFORMITY**

A Certificate of Conformity shall be established as defined in ESA/SCC Basic Specification No. 20100.

11. **DELIVERY**

For qualification approval, the disposition of the qualification test lot and its related documentation shall be as specified in ESA/SCC Basic Specification No. 20100 and the relevant paragraphs of Section 10 of this specification.

For procurement, for each order, the items forming the delivery are:-

- (a) The delivery lot.
- (b) The components used for lot acceptance testing, (when applicable), but not forming part of the delivery lot (see Paras. 8.2.3(d), 8.2.4(b) and 8.2.5(b)).
- (c) The relevant documentation in accordance with the requirements of Section 10 of this specification.

In the case of a component for which a valid qualification approval is in force, all data of all components submitted to LA1 and LA2 testing shall also be copied, when requested, to the relevant Qualifying Space Agency.

12. **PACKAGING AND DESPATCH**

The packaging and despatch of components to this specification shall be in accordance with the requirements of ESA/SCC Basic Specification No. 20600.



**ANNEXE I**

**LTPD SAMPLING PLAN LOT SIZES GREATER THAN 200 DEVICES**

Minimum size of sample to be tested to assure with a 90% confidence that a lot whose Percent Defective equals the specified LTPD is not accepted (single sample).

Max. Percent Defective (LTPD) or $\lambda$	50	30	20	15	10	7	5	3	2	1.5	1	0.7	0.5	0.3	0.2	0.15	0.1
Acceptance Number (c) (r = c + 1)	MINIMUM SAMPLE SIZES (FOR DEVICE-HOURS REQUIRED FOR LIFE TEST, MULTIPLY BY 1000)																
0	5 (1.03)	8 (0.64)	11 (0.46)	15 (0.34)	22 (0.23)	32 (0.16)	45 (0.11)	76 (0.07)	116 (0.04)	153 (0.03)	231 (0.02)	328 (0.02)	461 (0.01)	767 (0.007)	1152 (0.005)	1534 (0.003)	2303 (0.002)
1	8 (4.4)	13 (2.7)	18 (2.0)	25 (1.4)	38 (0.94)	55 (0.65)	77 (0.46)	129 (0.28)	195 (0.18)	258 (0.14)	390 (0.09)	555 (0.06)	778 (0.045)	1296 (0.027)	1946 (0.018)	2592 (0.013)	3891 (0.009)
2	11 (7.4)	18 (4.5)	25 (3.4)	34 (2.24)	52 (1.6)	75 (1.1)	105 (0.78)	176 (0.47)	266 (0.31)	354 (0.23)	533 (0.15)	759 (0.11)	1065 (0.080)	1773 (0.045)	2662 (0.031)	3547 (0.022)	5323 (0.015)
3	13 (10.5)	22 (6.2)	32 (4.4)	43 (3.2)	65 (2.1)	94 (1.5)	132 (1.0)	221 (0.62)	333 (0.41)	444 (0.31)	668 (0.20)	953 (0.14)	1337 (0.10)	2226 (0.062)	3341 (0.041)	4452 (0.031)	6681 (0.018)
4	16 (12.3)	27 (7.3)	38 (5.3)	52 (3.9)	78 (2.6)	113 (1.8)	158 (1.3)	265 (0.75)	398 (0.50)	531 (0.37)	798 (0.25)	1140 (0.17)	1599 (0.12)	2663 (0.074)	3997 (0.049)	5327 (0.037)	7994 (0.025)
5	19 (13.8)	31 (8.4)	45 (6.0)	60 (4.4)	91 (2.9)	131 (2.0)	184 (1.4)	308 (0.85)	462 (0.57)	617 (0.42)	927 (0.28)	1323 (0.20)	1855 (0.14)	3090 (0.085)	4638 (0.056)	6181 (0.042)	9275 (0.028)
6	21 (15.6)	35 (9.4)	51 (6.6)	68 (4.9)	104 (3.2)	149 (2.2)	209 (1.6)	349 (0.94)	528 (0.62)	700 (0.47)	1054 (0.31)	1503 (0.22)	2107 (0.155)	3509 (0.093)	5267 (0.062)	7019 (0.047)	10533 (0.031)
7	24 (16.6)	39 (10.2)	57 (7.2)	77 (5.3)	116 (3.5)	166 (2.4)	234 (1.7)	390 (1.0)	589 (0.67)	783 (0.51)	1178 (0.34)	1680 (0.24)	2355 (0.17)	3922 (0.101)	5886 (0.067)	7845 (0.051)	11771 (0.034)
8	26 (18.1)	43 (10.9)	63 (7.7)	85 (5.6)	128 (3.7)	184 (2.6)	258 (1.8)	431 (1.1)	648 (0.72)	864 (0.54)	1300 (0.36)	1854 (0.25)	2599 (0.18)	4329 (0.108)	6498 (0.072)	8660 (0.054)	12995 (0.036)
9	28 (19.4)	47 (11.5)	69 (8.1)	93 (6.0)	140 (3.9)	201 (2.7)	282 (1.9)	471 (1.2)	709 (0.77)	945 (0.58)	1421 (0.38)	2027 (0.27)	2842 (0.19)	4733 (0.114)	7103 (0.077)	9468 (0.057)	14206 (0.038)
10	31 (19.9)	51 (12.1)	75 (8.4)	100 (6.3)	152 (4.1)	218 (2.9)	306 (2.0)	511 (1.2)	770 (0.80)	1025 (0.60)	1541 (0.40)	2199 (0.28)	3082 (0.20)	5133 (0.120)	7704 (0.080)	10268 (0.060)	15407 (0.040)
11	33 (21.0)	54 (12.8)	83 (8.3)	111 (6.2)	166 (4.2)	238 (2.9)	332 (2.1)	555 (1.2)	832 (0.83)	1109 (0.62)	1664 (0.42)	2378 (0.29)	3323 (0.21)	5546 (0.12)	8319 (0.083)	11092 (0.062)	16638 (0.042)
12	36 (21.4)	59 (13.0)	89 (8.6)	119 (6.5)	178 (4.3)	254 (3.0)	356 (2.2)	594 (1.3)	890 (0.86)	1187 (0.65)	1781 (0.43)	2544 (0.3)	3562 (0.22)	5936 (0.13)	8904 (0.086)	11872 (0.065)	17808 (0.043)
13	38 (22.3)	63 (13.4)	95 (8.9)	126 (6.7)	190 (4.5)	271 (3.1)	379 (2.26)	632 (1.3)	948 (0.89)	1264 (0.67)	1896 (0.44)	2709 (0.31)	3793 (0.22)	6321 (0.134)	9482 (0.089)	12643 (0.067)	18964 (0.045)
14	40 (23.1)	67 (13.8)	101 (9.2)	134 (6.9)	201 (4.6)	288 (3.2)	403 (2.3)	672 (1.4)	1007 (0.92)	1343 (0.69)	2015 (0.46)	2878 (0.32)	4029 (0.23)	6716 (0.138)	10073 (0.092)	13431 (0.069)	20146 (0.046)
15	43 (23.3)	71 (14.1)	107 (9.4)	142 (7.1)	213 (4.7)	305 (3.3)	426 (2.36)	711 (1.41)	1066 (0.94)	1422 (0.71)	2133 (0.47)	3046 (0.33)	4265 (0.235)	7108 (0.141)	10662 (0.094)	14216 (0.070)	21324 (0.047)
16	45 (24.1)	74 (14.0)	112 (9.7)	150 (7.2)	225 (4.8)	321 (3.37)	450 (2.41)	750 (1.44)	1124 (0.96)	1499 (0.72)	2249 (0.48)	3212 (0.337)	4497 (0.241)	7496 (0.144)	11244 (0.096)	14992 (0.072)	22487 (0.048)
17	47 (24.7)	79 (14.7)	118 (9.86)	158 (7.36)	236 (4.93)	338 (3.44)	473 (2.46)	788 (1.48)	1182 (0.98)	1576 (0.74)	2364 (0.49)	3377 (0.344)	4728 (0.246)	7880 (0.148)	11819 (0.098)	15759 (0.074)	23639 (0.049)
18	50 (24.9)	83 (15.0)	124 (10.0)	165 (7.54)	248 (5.02)	354 (3.51)	496 (2.51)	826 (1.51)	1239 (1.0)	1652 (0.75)	2478 (0.50)	3540 (0.351)	4956 (0.251)	8260 (0.151)	12390 (0.100)	16520 (0.075)	24780 (0.050)
19	52 (25.5)	86 (15.4)	130 (10.2)	173 (7.76)	259 (5.12)	370 (3.58)	518 (2.56)	864 (1.53)	1296 (1.02)	1728 (0.77)	2591 (0.52)	3702 (0.358)	5183 (0.256)	8638 (0.153)	12957 (0.102)	17276 (0.077)	25914 (0.051)
20	54 (26.1)	90 (15.6)	135 (10.4)	180 (7.82)	271 (5.19)	386 (3.65)	541 (2.60)	902 (1.56)	1353 (1.04)	1803 (0.78)	2705 (0.52)	3864 (0.364)	5410 (0.260)	9017 (0.156)	13526 (0.104)	18034 (0.078)	27051 (0.052)
26	65 (27.0)	109 (16.1)	163 (10.8)	217 (8.08)	326 (5.38)	466 (3.76)	652 (2.69)	1086 (1.61)	1629 (1.08)	2173 (0.807)	3259 (0.538)	4656 (0.376)	6518 (0.269)	10863 (0.161)	16295 (0.108)	21726 (0.081)	32589 (0.054)

**NOTES**


- Sample sizes are based upon the Poisson exponential binomial limit.
- The minimum quality (approximate AQL) required to accept (on the average) 19 of 20 lots is shown in parentheses for information only.



ANNEXE I

LTPD SAMPLING PLAN LOT SIZES LESS THAN, OR EQUAL TO, 200 DEVICES

C=0																											
N	10		20		30		40		50		60		80		100		120		150		160		200				
n	AQL	LTPD	AQL	LTPD	AQL	LTPD	AQL	LTPD	AQL	LTPD	AQL	LTPD	AQL	LTPD	AQL	LTPD	AQL	LTPD	AQL	LTPD	AQL	LTPD	AQL	LTPD			
2	2.2	65	2.5	66	2.5	67	2.5	67	2.5	67	2.5	68	2.5	68	2.5	68	2.5	68	2.5	68	2.5	68	2.5	68	2.5	68	
4	1.2	36	1.2	40	1.2	42	1.2	42	1.3	42	1.3	43	1.3	43	1.3	43	1.3	43	1.3	43	1.3	44	1.3	44	1.3	44	
5	1.0	29	1.0	33	1.0	34	1.0	35	1.0	35	1.0	35	1.0	36	1.0	36	1.0	37	1.0	37	1.0	37	1.0	37	1.0	37	
8	0.5	15	0.6	20	0.6	22	0.6	23	0.6	23	0.6	23	0.6	24	0.7	24	0.7	24	0.7	24	0.7	24	0.7	24	0.7	25	
10			0.4	15	0.5	17	0.5	19	0.5	19	0.5	19	0.5	20	0.5	20	0.5	20	0.5	20	0.5	20	0.5	20	0.5	20	
16			0.2	6.9	0.25	10	0.25	11	0.3	11	0.3	12	0.3	12	0.3	13	0.3	13	0.3	13	0.3	13	0.3	13	0.3	13	
20					0.2	6.8	0.2	8.0	0.25	8.7	0.25	9.0	0.25	9.4	0.25	10	0.25	10	0.25	10	0.25	10	0.25	10	0.25	11	
25					0.15	4.3	0.15	5.7	0.2	6.4	0.2	6.9	0.2	7.4	0.2	7.5	0.2	7.6	0.2	7.7	0.2	7.8	0.2	7.8	0.2	7.9	
32							0.1	3.7	0.1	4.4	0.1	5.0	0.1	5.5	0.1	5.9	0.15	6.0	0.15	6.2	0.15	6.3	0.15	6.3	0.15	6.3	
40									0.1	3.0	0.1	3.4	0.1	4.0	0.1	4.5	0.1	4.6	0.1	4.9	0.1	5.0	0.15	5.0	0.15	5.0	
50									0.1	2.3	0.1	2.9	0.10	3.3	0.10	3.5	0.10	3.5	0.10	3.7	0.10	3.7	0.10	3.7	0.10	3.9	
64											0.08	1.7	0.08	2.2	0.08	2.5	0.08	2.5	0.08	2.7	0.08	2.8	0.08	2.8	0.08	2.9	
80													0.07	1.5	0.07	1.7	0.07	1.7	0.07	2.0	0.07	2.1	0.07	2.1	0.07	2.2	
100															0.05	1.1	0.05	1.5	0.05	1.5	0.05	1.5	0.05	1.5	0.05	1.7	
125																	0.04	0.8	0.04	0.8	0.04	0.9	0.04	0.9	0.04	1.2	
128																			0.04	0.8	0.04	0.9	0.04	1.1	0.04	1.1	
160																				0.04	0.8	0.04	0.9	0.04	1.1	0.03	0.7
C=1																											
N	10		20		30		40		50		60		80		100		120		150		160		200				
n	AQL	LTPD	AQL	LTPD	AQL	LTPD	AQL	LTPD	AQL	LTPD	AQL	LTPD	AQL	LTPD	AQL	LTPD	AQL	LTPD	AQL	LTPD	AQL	LTPD	AQL	LTPD			
2	27	95	24	95	24	95	23	95	23	95	23	95	23	95	23	95	23	95	22	95	22	95	22	95	22	95	
4	15	62	12	66	12	66	11	67	11	67	10	67	10	67	10	67	10	67	9.8	67	9.7	67	9.7	68	9.7	68	
5	13	51	10	55	8.8	56	8.5	57	8.4	57	8.1	58	7.9	58	7.6	58	7.5	58	7.5	58	7.5	58	7.5	58	7.5	58	
8	11	28	7.2	35	6.2	38	5.8	38	5.4	39	5.0	39	4.7	39	4.5	39	4.3	39	4.3	40	4.2	40	4.2	40	4.2	40	
10			6.2	30	5.0	30	4.6	31	4.2	32	4.2	32	4.2	32	3.9	33	3.5	33	3.3	33	3.3	33	3.3	33	3.3	33	
16			5.6	15	4.2	18	3.8	18	3.4	20	3.0	20	2.9	21	2.6	21	2.5	21	2.3	21	2.3	22	2.3	22	2.2	22	
20					4.0	13	3.2	15	2.8	16	2.5	16	2.4	16	2.3	16	2.1	17	2.0	17	2.0	17	2.0	17	2.0	18	
25					3.8	9.2	3.1	11	2.5	12	2.2	13	2.0	13	1.8	13	1.7	13	1.6	14	1.6	14	1.6	14	1.6	14	
32							3.1	7.4	2.4	8.2	2.1	9.0	1.8	9.9	1.6	10	1.5	10.5	1.4	11	1.3	11	1.3	11	1.3	11	
40									2.4	5.9	2.1	6.8	1.6	7.6	1.4	7.8	1.3	8.2	1.2	8.3	1.2	8.4	1.2	8.4	1.2	8.6	
50											1.7	4.6	1.4	5.6	1.2	6.1	1.2	6.4	1.0	6.5	0.9	6.7	0.9	6.7	0.9	6.7	
64													1.3	3.8	1.1	4.4	1.0	4.7	0.8	5.0	0.8	5.0	0.8	5.0	0.7	5.2	
80															1.1	3.0	1.0	3.4	0.8	3.7	0.7	3.8	0.7	3.8	0.6	4.0	
100																	0.9	2.5	0.7	2.8	0.7	2.8	0.7	2.8	0.6	3.0	
125																			0.7	1.9	0.7	2.0	0.7	2.0	0.5	2.2	
128																				0.7	1.7	0.7	1.9	0.5	2.2	0.5	2.2
160																					0.7	1.7	0.5	2.2	0.5	1.5	
C=2																											
N	10		20		30		40		50		60		80		100		120		150		160		200				
n	AQL	LTPD	AQL	LTPD	AQL	LTPD	AQL	LTPD	AQL	LTPD	AQL	LTPD	AQL	LTPD	AQL	LTPD	AQL	LTPD	AQL	LTPD	AQL	LTPD	AQL	LTPD			
4	33	82	28	83	27	84	27	85	27	85	26	85	26	85	26	86	26	86	25	86	25	86	25	86	25	86	
5	27	69	23	73	21	74	20	74	20	74	20	75	20	75	19	75	19	75	19	75	19	75	19	75	19	75	
8	22	42	15	49	14	49	13	52	13	52	13	52	12	53	12	53	12	53	11	53	11	53	11	53	11	53	
10			13	39	11	42	11	42	10	43	10	43	9.6	43	9.2	44	9.1	44	8.9	44	8.9	44	8.7	44	8.7	44	
16			11	22	8.6	25	6.9	27	6.8	27	6.4	27	6.0	28	6.0	29	5.9	29	5.9	29	5.7	29	5.5	30	5.5	30	
20					7.7	19	6.2	21	5.9	22	5.6	22	5.1	23	4.8	23	4.8	23	4.6	23	4.5	24	4.5	24	4.5	24	
25					7.4	13	6.0	16	4.9	17	4.5	17	4.3	18	4.1	18	3.9	18	3.7	18	3.7	19	3.7	19	3.7	19	
32							5.5	11	4.8	12	4.3	13	3.6	14	3.4	14	3.2	14	3.0	14.5	3.0	15	2.9	15	2.9	15	
40									4.6	8.9	3.9	9.8	3.1	11	2.8	12	2.6	12	2.4	12	2.4	12	2.3	12	2.3	12	
50											3.5	6.9	2.8	8.1	2.4	8.4	2.3	8.6	2.1	9.0	2.1	9.3	2.0	9.5	2.0	9.5	
64													2.6	5.7	2.2	6.2	2.0	6.6	1.8	7.1	1.7	7.1	1.6	7.4	1.6	7.4	
80															2.1	4.5	1.8	4.9	1.6	5.4	1.5	5.4	1.4	5.6	1.4	5.6	
100																	1.8	3.5	1.4	3.9	1.4	4.0	1.2	4.4	1.2	4.4	
125																			1.4	2.8	1.3	2.9	1.1	3.3	1.1	3.3	
128																				1.4	2.6	1.3	2.9	1.1	3.2	1.1	3.2
160																					1.3	2.9	1.1	3.2	1.1	2.3	

	ESA/SCC Generic Specification No. 3502	PAGE 38 ISSUE 2
---	---	--------------------

ANNEXE I

Page 3 of 3

This table gives the AQL and LTPD values associated with certain single sampling plans (Acceptance Number "C", Sample Size "n" and Lot Size "N"). The table has the following features:-

- (a) Calculations are based upon the hyper-geometric distribution (exact theory) for lot sizes of 200 devices or less.
- (b) The AQL of a sampling plan is defined as the interpolated Percent Defective for which there is a 0.95 probability of acceptance under the plan. The AQL so defined need not be a realisable Lot Percent Defective for the lot size involved (e.g., 12 percent is not a realisable Percent Defective for a lot size of 20 devices).
- (c) The LTPD of a sampling plan is defined as the interpolated Percent Defective for which there is a 0.10 probability of lot acceptance under the plan. The LTPD so defined need not be a realisable Lot Percent Defective for the lot size involved.
- (d) The sequence of sample sizes and lot sizes are generated by taking products of preceding numbers in the respective sequences and the numbers 2 and 5.