



europaean space agency  
agence spatiale européenne

Pages 1 to 23

**ISOLATORS, COAXIAL/DROP-IN**



**420 MHz - 18 GHz**

**BASED ON SERIES 20\*XXXX AND 29\*XXXX**

**ESA/SCC Detail Specification No. 3202/019**

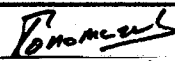
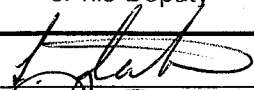
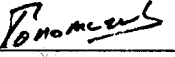

**space components  
coordination group**

Issue/Rev.	Date	Approved by	
		SCCG Chairman	ESA Director General or his Deputy
Issue 1	March 1994		
Revision 'A'	April 1995		



**DOCUMENTATION CHANGE NOTICE**

Rev. Letter	Rev. Date	Reference	CHANGE Item	Approved DCR No.
'A'	April '95	P1. Cover page P2. DCN P7. Table 1(a)  P9. Figures 2(a) to 2(c) P11. Figures 2(e) to 2(f) P13. Figure 2(h) P14. Figure 2(i) P15. Figure 2(j)	: Correction of typographical errors : Variant 25 added : Variant 26 added : Dimension 'G' corrected in drawing : Dimension 'G' corrected in drawing : Dimension 'G' corrected in drawing : Dimension 'G' corrected in drawing : Dimension 'G' corrected in drawing	None None 23670 221242 221257 23699 23699 23699 23699 23699

 <b>SCC</b>	ESA/SCC Detail Specification No. 3202/019		PAGE 3 ISSUE 1
--	--	--	-------------------

## TABLE OF CONTENTS

		<u>Page</u>
<b>1.</b>	<b><u>GENERAL</u></b>	<b>5</b>
1.1	Scope	5
1.2	Type Variants	5
1.3	Maximum Ratings	5
1.4	Physical Dimensions	5
1.5	Functional Diagram	5
<b>2.</b>	<b><u>APPLICABLE DOCUMENTS</u></b>	<b>5</b>
<b>3.</b>	<b><u>TERMS, DEFINITIONS, ABBREVIATIONS, SYMBOLS AND UNITS</u></b>	<b>5</b>
<b>4.</b>	<b><u>REQUIREMENTS</u></b>	<b>16</b>
4.1	General	16
4.2	Deviations from Generic Specification	16
4.2.1	Deviations from Special In-process Controls	16
4.2.2	Deviations from Final Production Tests	16
4.2.3	Deviations from Burn-in and Electrical Measurements	16
4.2.4	Deviations from Qualification Tests	16
4.2.5	Deviations from Lot Acceptance Tests	16
4.3	Mechanical Requirements	16
4.3.1	Contact Engagement and Separation Forces	16
4.3.2	Voltage Proof	17
4.3.3	Weight	17
4.3.4	Coupling Proof Torque	17
4.3.5	Mating and Unmating Forces	17
4.3.6	Centre Contact Retention	17
4.3.7	Dimension Check	17
4.3.8	Endurance	17
4.4	Materials and Finishes	18
4.4.1	General	18
4.4.2	Body	18
4.4.3	Connector Receptacle	18
4.4.4	Tab	18
4.5	Marking	18
4.5.1	General	18
4.5.2	Input and Output Port Identification	18
4.5.3	The SCC Component Number	18
4.5.4	Traceability Information	18
4.6	Electrical Measurements	19
4.6.1	Electrical Measurements at Room Temperature	19
4.6.2	Electrical Measurements at High and Low Temperatures	19
4.6.3	Circuits for Electrical Measurements	19
4.7	Burn-in Tests	19
4.8	Environmental and Endurance Tests	22
4.8.1	Measurements and Inspections on Completion of Environmental Tests	22
4.8.2	Measurements and Inspections at Intermediate Points and on Completion of Endurance Tests	22
4.8.3	Conditions for Operating Life Tests	22
4.8.4	Electrical Circuits for Operating Life Tests	22

 	<p style="text-align: center;">ESA/SCC Detail Specification No. 3202/019</p>		<p>PAGE 4 ISSUE 1</p>
--	--	--	---------------------------

**TABLES**



		<u>Page</u>
1(a)	Type Variants	6
1(b)	Maximum Ratings	8
2	Electrical Measurements at Room Temperature	20
3	Electrical Measurements at High and Low Temperatures	20
4	Parameter Drift Values	N/A
5	Conditions for Operating Life Test	21
6	Measurements and Inspections on Completion of Environmental Tests and at Intermediate Points and on Completion of Endurance Tests	23

**FIGURES**

1	Parameter Derating Information	N/A
2	Physical Dimensions	9
3	Functional Diagram	16
4	Circuits for Electrical Measurements	N/A
5	Electrical Circuit for Operating Life Test	21

**APPENDICES (Applicable to specific Manufacturers only)**

None.

 	<p style="text-align: center;">ESA/SCC Detail Specification No. 3202/019</p>	<p style="text-align: right;">PAGE 5 ISSUE 1</p>
--	--	--

**1. GENERAL**

**1.1 SCOPE**

This specification details the ratings, physical and electrical characteristics, test and inspection data for an Isolator, Coaxial/Drop-in, 420 MHz - 18 GHz, based on Series 20\*XXXX and 29\*XXXX. It shall be read in conjunction with ESA/SCC Generic Specification No. 3202, the requirements of which are supplemented herein.

**1.2 TYPE VARIANTS**

Variants of the basic type isolators specified herein, which are also covered by this specification, are given in Table 1(a).

**1.3 MAXIMUM RATINGS**

The maximum ratings, which shall not be exceeded at any time during use or storage, applicable to the isolators specified herein, are as scheduled in Table 1(b).

**1.4 PHYSICAL DIMENSIONS**

The physical dimensions of the isolators specified herein, are shown in Figure 2.

**1.5 FUNCTIONAL DIAGRAM**

The functional diagram, showing port identification of the isolators specified herein, is shown in Figure 3.

**2. APPLICABLE DOCUMENTS**

The following documents form part of this specification and shall be read in conjunction with it:-

- (a) ESA/SCC Generic Specification No. 3202, Ferrite Microwave Components, Isolators and Circulators.
- (b) ESA/SCC Detail Specification No. 3402/001, RF Coaxial Connectors type SMA (Male Contact).
- (c) ESA/SCC Detail Specification No. 3402/002, RF Coaxial Connectors type SMA (Female Contact).

**3. TERMS, DEFINITIONS, ABBREVIATIONS, SYMBOLS AND UNITS**

For the purpose of this specification, the terms, definitions, abbreviations, symbols and units specified in ESA/SCC Basic Specification No. 21300 shall apply.



**TABLE 1(a) - TYPE VARIANTS**

(1) VARIANT	(2) BASED ON TYPE	(3) CENTRE FREQ. (f <sub>c</sub> ) (GHz)	(4) MIN. BANDWIDTH (B) (GHz)	(5) MINIMUM ISOLATION (ISO) (dB)	(6) MAXIMUM INSERTION LOSS (IL) (dB)	(7) MINIMUM RETURN LOSS		(8) INTERFACES (NOTE 1)		(9) OPERATING TEMP. RANGE		(10) FIGURE	(11) CONFIG. AND FUNCT. DIAG.
						INPUT RLIN (dB)	OUTPUT RLOUT (dB)	INPUT	OUTPUT	MIN. (°C)	MAX. (°C)		
01	20*6601	7.4	0.6	20.0	0.5	19.1	19.1	SMA(F)	M4 TAB	-54	+95	2(d)	3(e)
02	20*6601	7.4	0.6	20.0	0.5	19.1	19.1	SMA(M)	M4 TAB	-54	+95	2(d)	3(f)
03	20*6601	7.4	0.6	20.0	0.5	19.1	19.1	SMA(F)	SMA(M)	-54	+95	2(d)	3(e)
04	20*2501	15.0	6.0	20.0	0.5	19.1	19.1	SMA(F)	SMA(M)	-54	+95	2(d)	3(e)
05	29*1601	1.667	0.1	20.0	0.5	19.1	19.1	M7 TAB	M7 TAB	-20	+80	2(e)	3(a)
06	29*1601	1.667	0.1	20.0	0.5	19.1	19.1	M7 TAB	M7 TAB	-20	+80	2(e)	3(b)
07	29*1601	1.704	0.1	20.0	0.5	19.1	19.1	M7 TAB	M7 TAB	-20	+80	2(e)	3(a)
08	29*1601	1.704	0.1	20.0	0.5	19.1	19.1	M7 TAB	M7 TAB	-20	+80	2(e)	3(b)
09	20*2001	8.153	0.1	20.0	0.4	19.1	19.1	SMA(M)	SMA(F)	-20	+80	2(d)	3(c)
10	20*2001	8.153	0.1	20.0	0.4	19.1	19.1	SMA(M)	SMA(F)	-20	+80	2(d)	3(f)
11	29*1401	2.25	0.1	20.0	0.5	19.1	19.1	M7 TAB	M7 TAB	-40	+80	2(e)	3(d)
12	29*1401	2.25	0.1	20.0	0.5	19.1	19.1	M7 TAB	M7 TAB	-40	+80	2(e)	3(c)
13	20*2001	8.153	0.1	20.0	0.4	19.1	19.1	SMA(M)	SMA(F)	-20	+80	2(d)	3(a)
14	20*2001	8.153	0.1	20.0	0.4	19.1	19.1	SMA(M)	SMA(F)	-20	+80	2(d)	3(b)
15	29*1601	1.704	0.02	20.0	0.3	19.1	19.1	M7 TAB	M7 TAB	-20	+70	2(e)	3(a)
16	29*1601	1.704	0.02	20.0	0.3	19.1	19.1	M7 TAB	M7 TAB	-20	+70	2(e)	3(b)

**NOTES**

- Interfaces are defined as follows:-  
Connectors: "SMA(F)" = SMA Female, "SMA(M)" = SMA Male.  
Tabs: "M4 TAB" or "M7 TAB" in accordance with Para. 4.4.4 of this specification.
- The Insulation Resistance for devices without resistive loads shall be 5.0MΩ minimum.



**SEC**

ESA/SCC Detail Specification

No. 3202/019

Rev. 'A'

PAGE 7

ISSUE 1

**TABLE 1(a) - TYPE VARIANTS (CONTINUED)**

(1) VARIANT	(2) BASED ON TYPE	(3) CENTRE FREQ. (f <sub>c</sub> ) (GHz)	(4) MIN. BANDWIDTH (B) (GHz)	(5) MINIMUM ISOLATION (ISO) (dB)	(6) MAXIMUM INSERTION LOSS (IL) (dB)	(7) MINIMUM RETURN LOSS		(8) INTERFACES (NOTE 1)		(9) OPERATING TEMP. RANGE		(10) FIGURE	(11) CONFIG. AND FUNCT. DIAG.
						INPUT RLIN (dB)	OUTPUT RLOUT (dB)	INPUT	OUTPUT	MIN. (°C)	MAX. (°C)		
17	20*1601	1.704	0.1	20.0	0.5	19.1	19.1	SMA(F)	SMA(F)	-54	+95	2(g)	3(b)
18	29*1601	1.667	0.1	20.0	0.5	19.1	19.1	M7TAB	M7TAB	-20	+80	2(f)	3(c)
19	29*6601	7.4	0.6	20.0	0.5	19.1	19.1	M7TAB	M7TAB	-54	+95	2(b)	3(d)
20	29*6601	7.4	0.6	20.0	0.5	19.1	19.1	M7TAB	M7TAB	-54	+95	2(a)	3(f)
21	29*6601	7.4	0.6	20.0	0.5	19.1	19.1	M7TAB	M7TAB	-54	+95	2(c)	3(e)
22	29*1401	1.2	0.12	20.0	0.5	19.1	19.1	M7TAB	M7TAB	-54	+95	2(i)	3(a)
23	20*1401	1.2	0.12	20.0	0.5	19.1	19.1	SMA(F)	SMA(F)	-54	+95	2(h)	3(b)
24	29*0701	0.43	0.04	20.0	0.5	19.1	19.1	M7TAB	M7TAB	-54	+95	2(j)	3(c)
25	20*2001	11.95	0.11	30.0	0.3	23	23	SMA(F)	SMA(F)	-10	+60	2(d)	3(b)
26	20*0001	0.425	0.01	17.0	0.5	17	17	SMA(F)	SMA(M)	-54	+95	2(j)	3(e)

**NOTES**

1. Interfaces are defined as follows:-

Connectors: "SMA(F)" = SMA Female, "SMA(M)" = SMA Male.

Tabs: "M4 TAB" or "M7 TAB" in accordance with Para. 4.4.4 of this specification.

2. The Insulation Resistance for devices without resistive loads shall be 5.0MΩ minimum.

**TABLE 1(b) - MAXIMUM RATINGS**

No.	CHARACTERISTICS	SYMBOL	MAXIMUM RATINGS	UNIT	REMARKS
1	Frequency Range	-	2.5 to 18 1.65 to 3.7 0.5 to 1.65 0.42 to 1.215	GHz GHz GHz GHz	Figure 2(a) to (d) Figure 2(e) to (g) Figure 2(h) to (i) Figure 2(j)
2	Peak RF Power	$P_p$	200 1000	W W	Figure 2(a) to (i) Figure 2(j)
	Peak RF Power Duration	-	50	$\mu$ s	-
	Peak RF Power Duty Cycle	-	25 50 15	% % %	Figure 2(a) to (g) Figure 2(h) to (i) Figure 2(j)
3	Rated RF Power (Continuous Reflected)	P	0.5 1.0 1.5	W W W	Figure 2(a) to (g) Figure 2(h) to (i) Figure 2(j)
4	Load RF Power (Reflected)	$P_L$	2.0 10	W W	Figure 2(a) to (i) Figure 2(j)
	Load RF Power Duration	-	50	$\mu$ s	-
	Load RF Power Duty Cycle	-	25 50 15	% % %	Figure 2(a) to (g) Figure 2(h) to (i) Figure 2(j)
5	Minimum RF Leakage	E	- 70	dBc	Note 1
6	Operating Temperature Range	$T_{op}$	Note 2	$^{\circ}$ C	$T_{amb}$
7	Storage Temperature Range	$T_{stg}$	- 60 to + 125	$^{\circ}$ C	-
8	Maximum Tab Soldering Temperature	$T_{sol}$	+ 240	$^{\circ}$ C	Note 3

**NOTES**

1. This parameter is not applicable to devices with one, or more, tab connections.
2. The Operating Temperature Range for a Type Variant shall be as specified in Column 9 of Table1(a). The Operating Temperature Range shall not exceed the Storage Temperature Range.
3. Duration 5 seconds maximum at a distance of not less than 1.5mm from the body and the same termination shall not be resoldered until 3 minutes have elapsed.

**FIGURE 1 - PARAMETER DERATING INFORMATION**

Not applicable.





**FIGURE 2 - PHYSICAL DIMENSIONS**

**FIGURES 2(a) TO 2(c) - 1/2" DROP-IN**

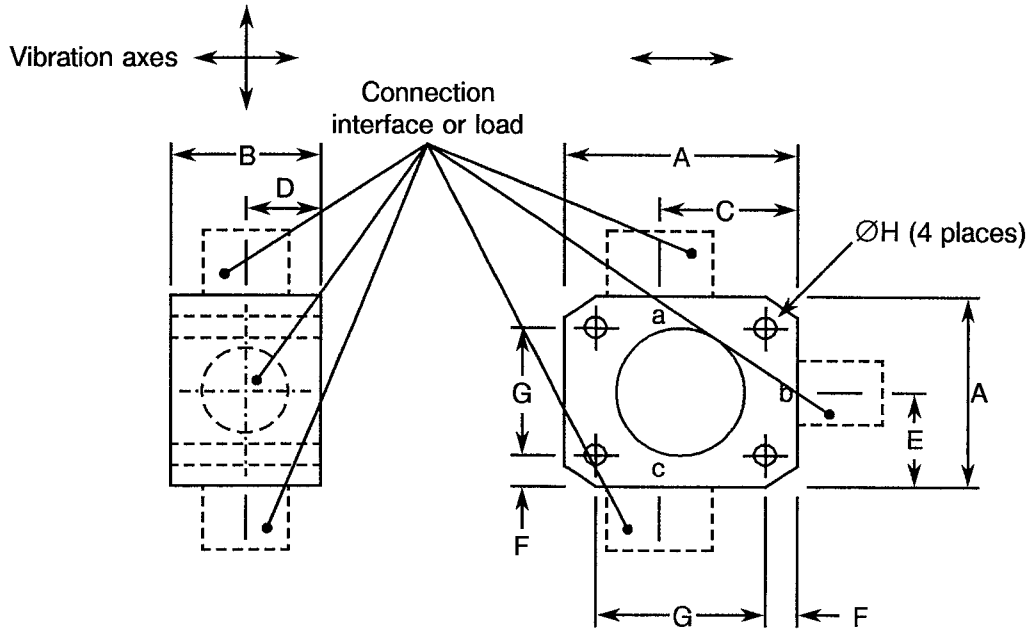

Connection interface or load as follows:

TAB

LOAD

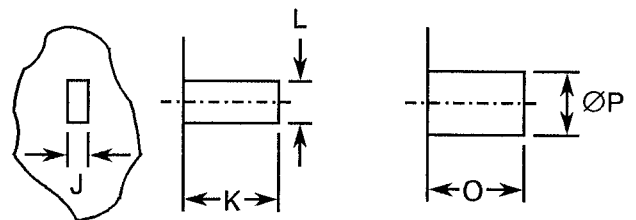

SYMBOL	MILLIMETRES		NOTES
	MIN.	MAX.	
A	-	12.95	Figure 2(a) Figure 2(b) Figure 2(c)
B	-	6.60	
C	8.13	8.64	
D	2.92	3.18	
	2.16	2.41	
	1.78	2.03	
E	6.10	6.60	
F	1.27	1.78	
G	9.40	9.91	
ØH	1.75	2.05	
J	0.10	0.15	
K	1.27	2.29	
L	0.51	0.76	
O	-	5.85	
ØP	-	5.08	

**NOTES**

1. Ports shall be marked as specified in Figure 3.



**FIGURE 2 - PHYSICAL DIMENSIONS (CONTINUED)**

**FIGURE 2(d) - 1/2" CONNECTORISED/DROP-IN**

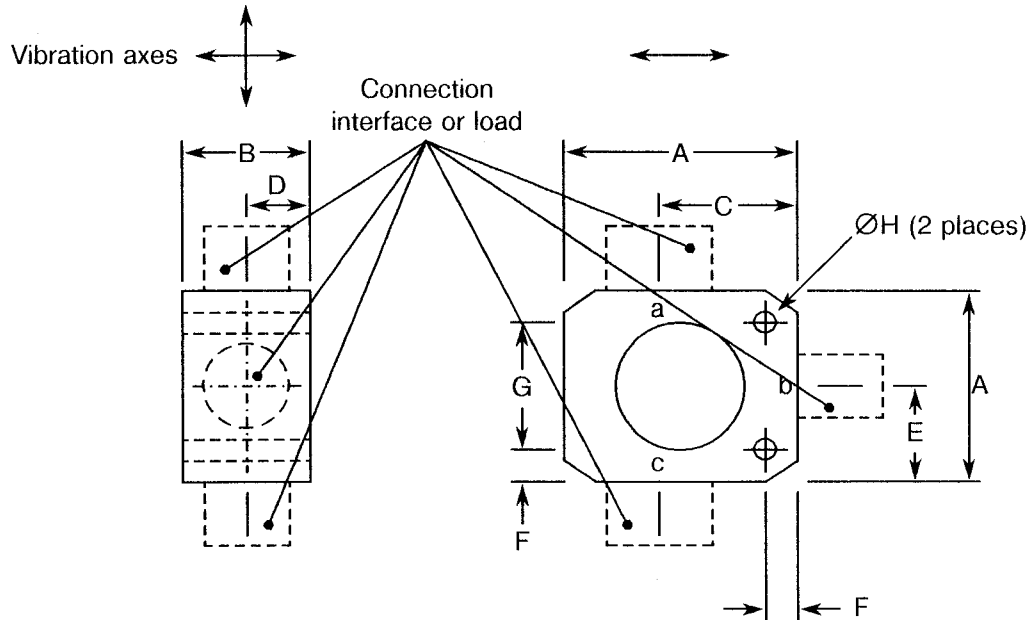

SYMBOL	MILLIMETRES	
	MIN.	MAX.
A	-	12.95
B	-	12.95
C	8.13	8.64
D	6.10	6.60
E	6.10	6.60
F	1.27	1.78
G	9.40	9.91
ØH	1.75	2.05
J	0.10	0.15
K	1.27	2.29
L	0.51	0.76
M	-	9.02
N	-	11.30
O	-	8.89
ØP	-	6.60

Connection interface or load as follows:  
SMA

Female (2)

Male (3)

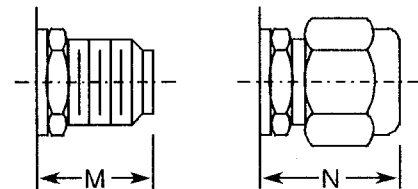

TAB

LOAD

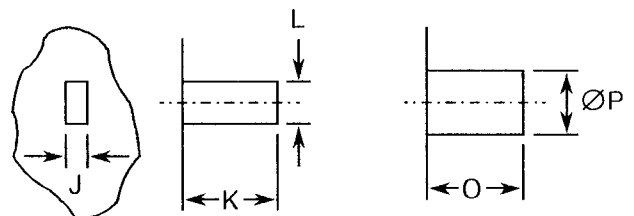

**NOTES**

1. Ports shall be marked as specified in Figure 3.
2. Full dimensions of the Female SMA interface are specified in ESA/SCC Detail Specification No. 3402/002.
3. Full dimensions of the Male SMA interface are specified in ESA/SCC Detail Specification No. 3402/001.



**FIGURE 2 - PHYSICAL DIMENSIONS (CONTINUED)**

**FIGURES 2(e) TO 2(f) - 3/4" DROP-IN**

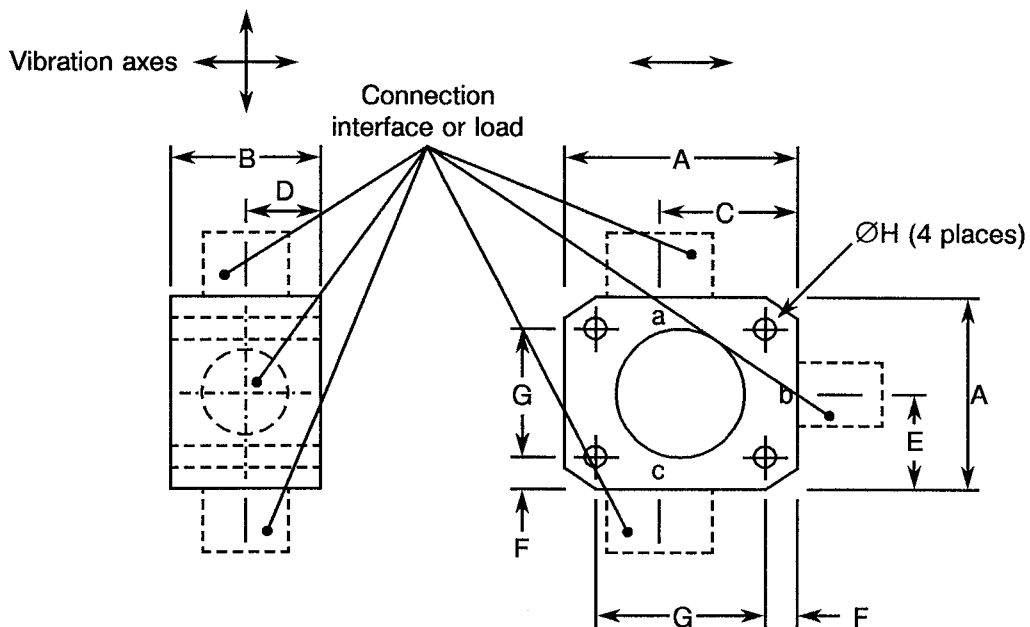

Connection interface or load as follows:

TAB

LOAD

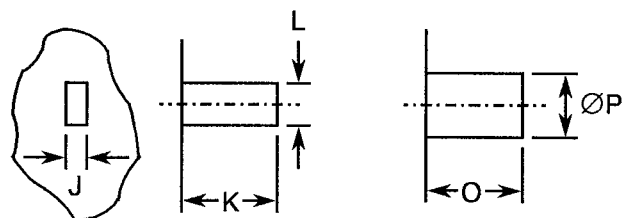

SYMBOL	MILLIMETRES		NOTES
	MIN.	MAX.	
A	-	19.30	Figure 2(e) Figure 2(f)
B	-	6.60	
C	12.57	13.08	
D	2.92	3.18	
E	2.41	2.67	
F	9.40	9.65	
G	0.20	0.25	
ØH	14.22	14.73	
J	1.88	2.18	
K	0.10	0.15	
L	1.27	2.29	
O	0.51	0.76	
ØP	-	5.85	
	-	5.08	

**NOTES**

- Ports shall be marked as specified in Figure 3.

**FIGURE 2 - PHYSICAL DIMENSIONS (CONTINUED)**

**FIGURE 2(g) - 3/4" CONNECTORISED/DROP-IN**

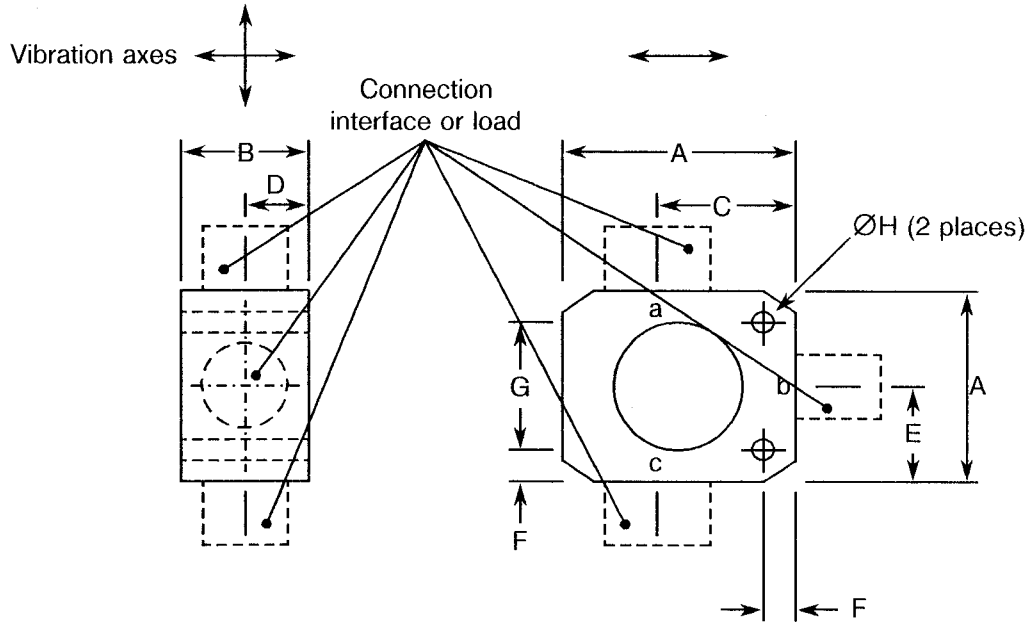

SYMBOL	MILLIMETRES	
	MIN.	MAX.
A	-	19.30
B	-	12.95
C	12.57	13.08
D	6.10	6.60
E	9.40	9.65
F	0.20	0.25
G	14.22	14.73
ØH	1.88	2.18
J	0.10	0.15
K	1.27	2.29
L	0.51	0.76
M	-	9.02
N	-	11.30
O	-	8.89
ØP	-	6.60

Connection interface or load as follows:  
SMA

Female (2)

Male (3)

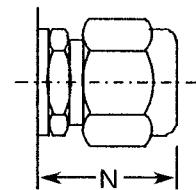
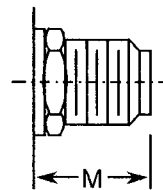

TAB

LOAD

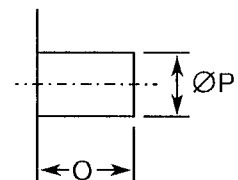
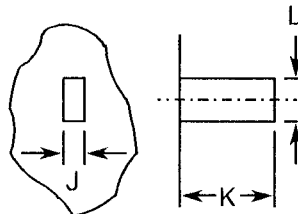

**NOTES**

1. Ports shall be marked as specified in Figure 3.
2. Full dimensions of the Female SMA interface are specified in ESA/SCC Detail Specification No. 3402/002.
3. Full dimensions of the Male SMA interface are specified in ESA/SCC Detail Specification No. 3402/001.



**FIGURE 2 - PHYSICAL DIMENSIONS (CONTINUED)**

**FIGURE 2(h) - 1" DROP-IN**

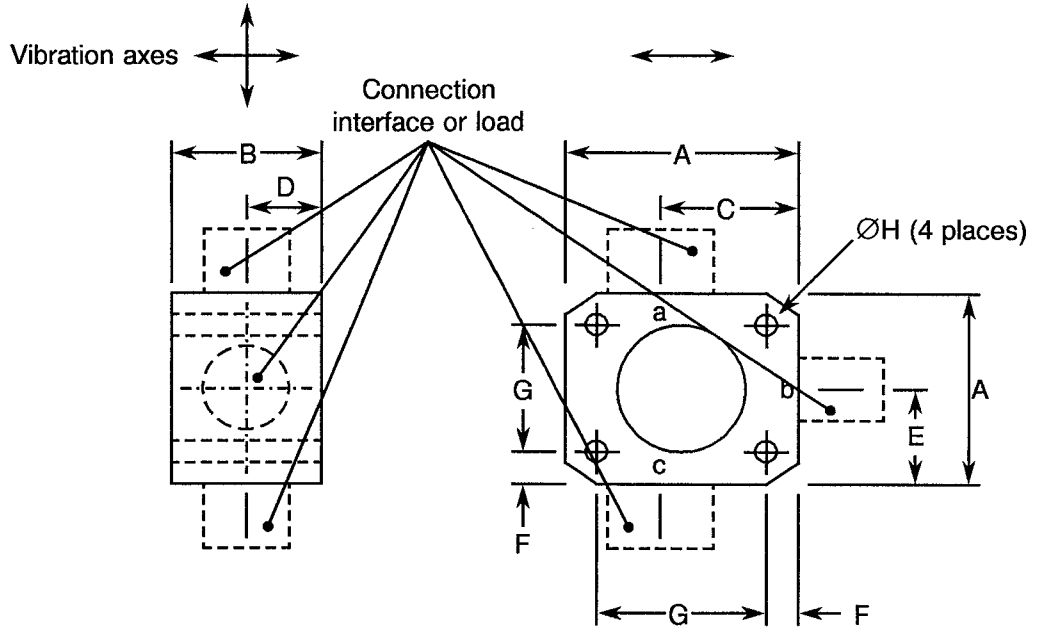

Connection interface or load as follows:

TAB

LOAD

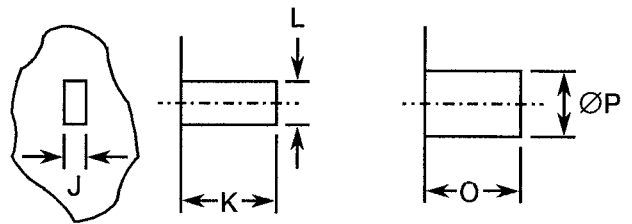

SYMBOL	MILLIMETRES	
	MIN.	MAX.
A	-	19.30
B	-	7.87
C	12.57	13.08
D	3.56	4.06
E	9.40	9.65
F	2.03	2.54
G	14.22	14.73
ØH	1.88	2.18
J	0.10	0.15
K	1.27	2.29
L	0.51	0.76
O	-	5.85
P	-	5.08

**NOTES**

1. Ports shall be marked as specified in Figure 3.



**FIGURE 2 - PHYSICAL DIMENSIONS (CONTINUED)**

**FIGURE 2(i) - 1" CONNECTORISED/DROP-IN**

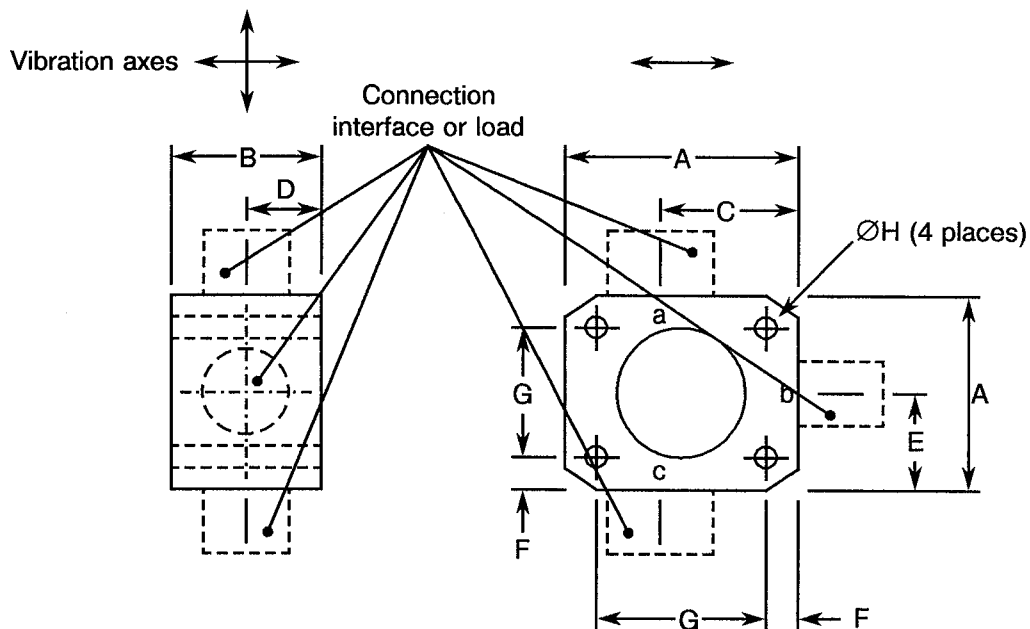

Connection interface or load as follows:  
SMA

Female (2)

Male (3)

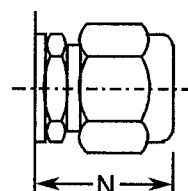
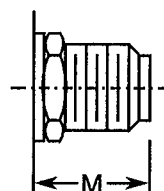

TAB

LOAD

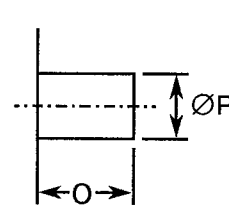
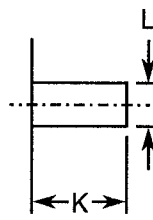
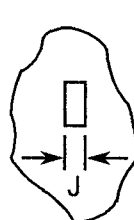

SYMBOL	MILLIMETRES	
	MIN.	MAX.
A	-	19.30
B	-	12.95
C	12.57	13.08
D	6.10	6.60
E	9.40	9.65
F	2.03	2.54
G	14.22	14.73
ØH	1.88	2.18
J	0.10	0.15
K	1.27	2.29
L	0.51	0.76
M	-	9.02
N	-	11.30
O	-	8.89
ØP	-	6.60

**NOTES**

1. Ports shall be marked as specified in Figure 3.
2. Full dimensions of the Female SMA interface are specified in ESA/SCC Detail Specification No. 3402/002.
3. Full dimensions of the Male SMA interface are specified in ESA/SCC Detail Specification No. 3402/001.



**FIGURE 2 - PHYSICAL DIMENSIONS (CONTINUED)**

**FIGURE 2(i) - 1 1/2" CONNECTORISED/DROP-IN**

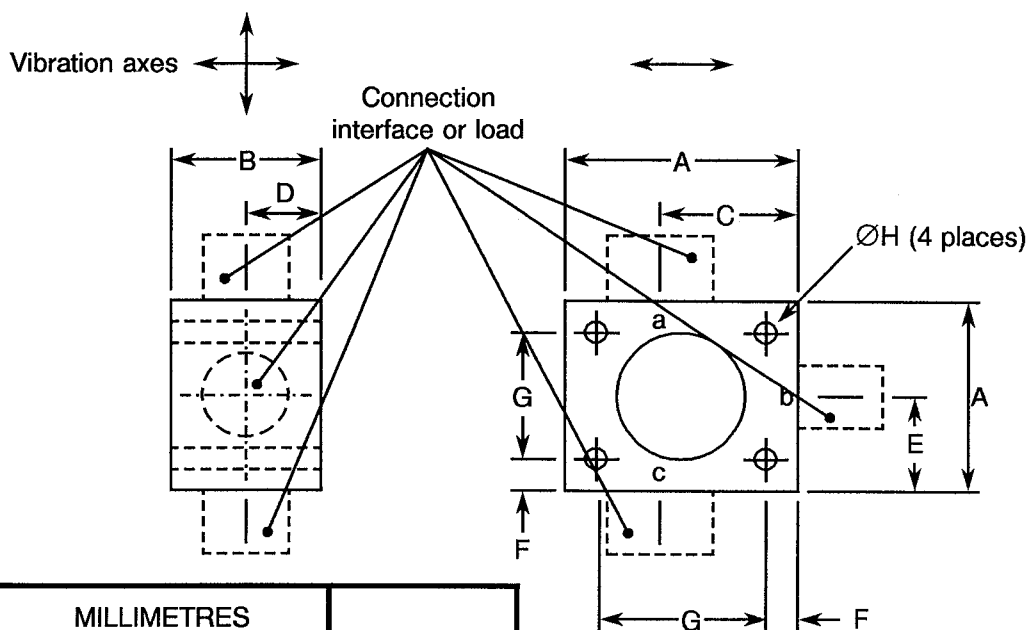

SYMBOL	MILLIMETRES		NOTES
	MIN.	MAX.	
A	-	38.35	
B	-	12.95	
C	27.43	27.94	
D	6.10	6.60	
E	18.80	19.30	
F	3.05	3.56	
G	31.24	31.75	
ØH	3.76	4.16	
J	0.10	0.15	
K	1.27	2.29	
L	0.51	0.76	
M	-	9.02	
N	-	11.30	
O	-	5.85	4
	-	8.89	5
ØP	-	5.08	4
	-	6.60	5

Connection interface or load as follows:  
SMA

Female (2)

Male (3)

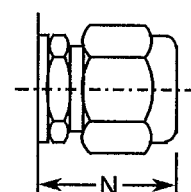
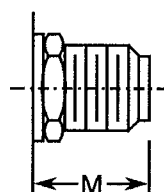

TAB

LOAD

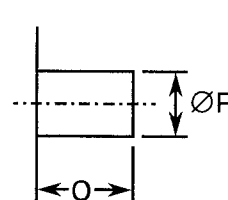
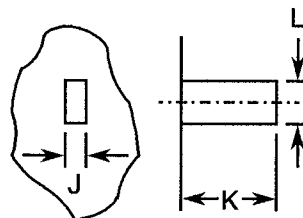

**NOTES**

1. Ports shall be marked as specified in Figure 3.
2. Full dimensions of the Female SMA interface are specified in ESA/SCC Detail Specification No. 3402/002.
3. Full dimensions of the Male SMA interface are specified in ESA/SCC Detail Specification No. 3402/001.
4. Devices with two tabs.
5. Devices with one, or more, connectors.

**FIGURE 3 - FUNCTIONAL DIAGRAM**

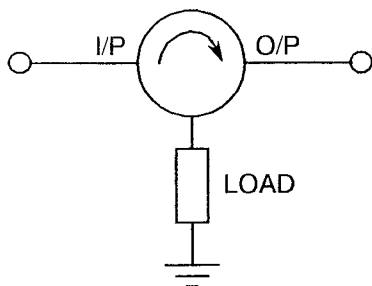

FIGURE	PORT		
	a	b	c
3(a)	I/P	O/P	LOAD
3(b)	O/P	I/P	LOAD
3(c)	LOAD	O/P	I/P
3(d)	LOAD	I/P	O/P
3(e)	O/P	LOAD	I/P
3(f)	I/P	LOAD	O/P

**4. REQUIREMENTS**

**4.1 GENERAL**

The complete requirements for procurement of the isolators specified herein shall be as stated in this specification and ESA/SCC Generic Specification No. 3202. Deviations from the Generic Specification, applicable to this Detail Specification only, are listed in Para. 4.2.

Deviations from the applicable Generic Specifications and this Detail Specification, formally agreed with specific Manufacturers on the basis that the alternative requirements are equivalent to the ESA/SCC requirements and do not affect the components' reliability, are listed in the appendices attached to this specification.

**4.2 DEVIATIONS FROM GENERIC SPECIFICATION**

**4.2.1 Deviations from Special In-process Controls**

None.

**4.2.2 Deviations from Final Production Tests (Chart II)**

- (a) Para. 9.6, Seal Test: Shall not be performed.
- (b) Para. 9.12, Multipaction: Shall not be performed.

**4.2.3 Deviations from Burn-in and Electrical Measurements (Chart III)**

Not applicable.

**4.2.4 Deviations from Qualification Tests (Chart IV)**

- (a) Para. 9.6, Seal Test: Shall not be performed.

**4.2.5 Deviations from Lot Acceptance Tests (Chart V)**

- (a) Para. 9.6, Seal Test: Shall not be performed.

**4.3 MECHANICAL REQUIREMENTS**

**4.3.1 Contact Engagement and Separation Forces**

Where applicable, the test conditions shall be as specified in ESA/SCC Detail Specification Nos. 3402/001 or 3402/002.



4.3.2 Voltage Proof

Where applicable, the test conditions shall be as specified in ESA/SCC Detail Specification Nos. 3402/001 or 3402/002.

4.3.3 Weight

The maximum weight of the components specified herein shall be as follows:-

FIGURE	No. OF TABS	No. OF SMA CONNECTORS	MAXIMUM WEIGHT (g)
2(a) to 2(c)	2	0	6
2(d)	1	1	16
2(d)	0	2	21
2(e) to 2(f)	2	0	15
2(g)	1	1	27
2(g)	0	2	32
2(h)	2	0	26
2(i)	1	1	46
2(i)	0	2	51
2(j)	2	0	113
2(j)	1	1	123
2(j)	0	2	128

4.3.4 Coupling Proof Torque

Where applicable, the applied torque shall be as specified in ESA/SCC Detail Specification Nos. 3402/001 or 3402/002.

4.3.5 Mating and Unmating Forces

Where applicable, the maximum torque shall be as specified in ESA/SCC Detail Specification Nos. 3402/001 or 3402/002.

4.3.6 Centre Contact Retention

Where applicable, the test conditions shall be as specified in ESA/SCC Detail Specification Nos. 3402/001 or 3402/002.

4.3.7 Dimension Check

The dimensions of the components specified herein shall be verified in accordance with the requirements set out in Para. 9 of ESA/SCC Generic Specification No. 3202 and shall conform to those shown in Figure 2.

4.3.8 Endurance

Where applicable, the test conditions shall be as specified in ESA/SCC Detail Specification Nos. 3402/001 or 3402/002.

4.4 MATERIALS AND FINISHES

4.4.1 General

The materials and finishes shall be as specified herein. Where a definite material is not specified, a material which will enable the components specified herein to meet the performance requirements of this specification shall be used. Acceptance or approval of any constituent material does not guarantee acceptance of the finished product.

4.4.2 Body

Stainless Steel, plated 3.0µm (min) nickel.

4.4.3 Connector Receptacle

Where applicable, as per ESA/SCC Detail Specification Nos. 3402/001 or 3402/002.

4.4.4 Tab

Where applicable, the tab material shall be either Type 'M' with Type '4' finish or Type 'M' with Type '7' finish in accordance with the requirements of ESA/SCC Basic Specification No. 23500. The particular material and finish shall be as specified in Table 1(a).

4.5 MARKING

4.5.1 General

The marking of all components delivered to this specification shall be in accordance with the requirements of ESA/SCC Basic Specification No. 21700. Each component shall be marked in respect of:-

- (a) Port Identification.
- (b) The SCC Component Number.
- (c) Traceability Information.

4.5.2 Input and Output Port Identification

Input and Output Port identification shall be as shown in Table 1(a) and Figure 3.

4.5.3 The SCC Component Number

Each component shall bear the SCC Component Number which shall be constituted and marked as follows:

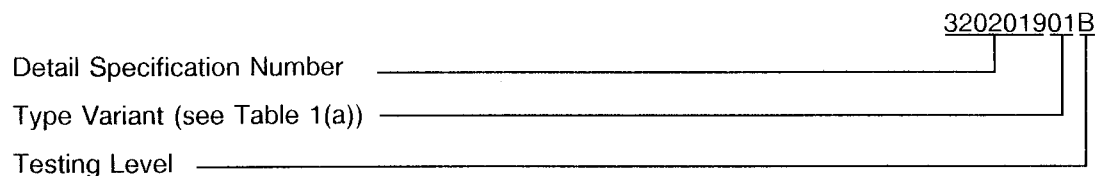

4.5.4 Traceability Information

Each component shall be marked in respect of traceability information in accordance with the requirements of ESA/SCC Basic Specification No. 21700.

	ESA/SCC Detail Specification No. 3202/019		PAGE 19 ISSUE 1
---	--	--	--------------------

4.6 ELECTRICAL MEASUREMENTS

4.6.1 Electrical Measurements at Room Temperature

The parameters to be measured at room temperature are scheduled in Table 2. The measurements shall be performed at  $T_{amb} = +22 \pm 3$  °C.

4.6.2 Electrical Measurements at High and Low Temperatures

The parameters to be measured at high and low temperatures are scheduled in Table 3. Measurements shall be performed at the temperature extremes as defined in Column 9 of Table 1(a).

4.6.3 Circuits for Electrical Measurements

Circuits for use in performing electrical measurements given in ESA/SCC Generic Specification No. 3202.

4.7 BURN-IN TESTS

Not applicable.

**TABLE 2 - ELECTRICAL MEASUREMENTS AT ROOM TEMPERATURE**

No.	CHARACTERISTICS	SYMBOL	ESA/SCC 3202 TEST METHOD AND CONDITION	LIMITS		UNIT
				MIN.	MAX.	
1	Isolation	ISO	Para. 9.7.1.2	Table 1(a) Column 5		dB
2	Insertion Loss	IL	Para. 9.7.1.3	Table 1(a) Column 6		dB
3	Return Loss Input Output	RL <sub>IN</sub> RL <sub>OUT</sub>	Para. 9.7.1.4	Table 1(a) Column 7		dB
4	Insulation Resistance (Note 1)	R <sub>i</sub>	Para. 9.7.1.5	5.0	-	MΩ

**NOTES**

1. Not applicable to devices with resistive loads.

**TABLE 3 - ELECTRICAL MEASUREMENTS AT HIGH AND LOW TEMPERATURES**

No.	CHARACTERISTICS	SYMBOL	ESA/SCC 3202 TEST METHOD AND CONDITION	LIMITS	
				MIN.	MAX.
1	Isolation	ISO	Para. 9.7.1.2	Table 1(a) Column 5	
2	Insertion Loss	IL	Para. 9.7.1.3	Table 1(a) Column 6	
3	Return Loss Input Output	RL <sub>IN</sub> RL <sub>OUT</sub>	Para. 9.7.1.4	Table 1(a) Column 7	

**FIGURE 4 - CIRCUITS FOR ELECTRICAL MEASUREMENTS**

Not applicable.

**TABLE 4 - PARAMETER DRIFT VALUES**

Not applicable.

**TABLE 5 - CONDITIONS FOR OPERATING LIFE TEST**

No.	CHARACTERISTICS	SYMBOL	CONDITION	UNIT	REMARKS
1	Centre Frequency	$f_c$	Table 1(a) Column 3	GHz	
2	Input Power	P	0.5 1.0 1.5	W W W	Fig 2(a) to 2(g) Fig 2(h) to (i) Fig 2(j)
3	Ambient Temperature	$T_{amb}$	Higher Temperature of Table 1(a) Column 9	°C	

**FIGURE 5 - ELECTRICAL CIRCUIT FOR OPERATING LIFE TEST**

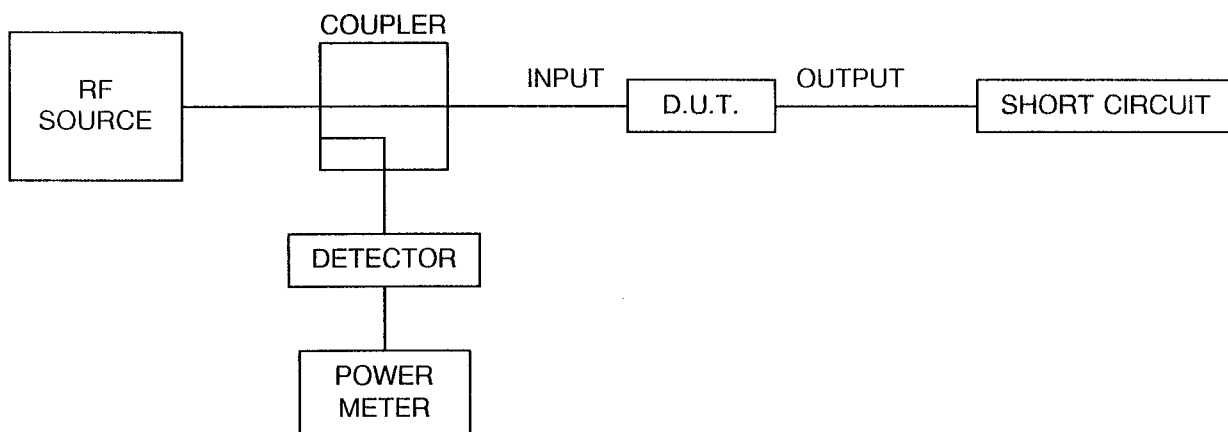

	ESA/SCC Detail Specification No. 3202/019		PAGE 22 ISSUE 1
--	--	--	--------------------

4.8 ENVIRONMENTAL AND ENDURANCE TESTS (CHARTS IV AND V OF ESA/SCC GENERIC SPECIFICATION NO. 3202)

4.8.1 Measurements and Inspections on Completion of Environmental Tests

The parameters to be measured and inspections to be performed on completion of environmental tests are scheduled in Table 6. Unless otherwise stated, the measurements shall be performed at  $T_{amb} = +22 \pm 3^{\circ}\text{C}$ .

4.8.2 Measurements and Inspections at Intermediate Points and on Completion of Endurance Tests

The parameters to be measured and inspections to be performed at intermediate points and on completion of endurance tests are scheduled in Table 6. Unless otherwise stated, the measurements shall be performed at  $T_{amb} = +22 \pm 3^{\circ}\text{C}$ .

4.8.3 Conditions for Operating Life Tests (Part of Endurance Testing)

The requirements for operating life testing are specified in Section 9 of ESA/SCC Generic Specification No. 3202. The conditions for operating life testing shall be as specified in Table 5 of this specification.

4.8.4 Electrical Circuits for Operating Life Tests

Circuits for use in performing the operating life tests are shown in Figure 5.

**TABLE 6 - MEASUREMENTS AND INSPECTIONS ON COMPLETION OF ENVIRONMENTAL TESTS AND AT INTERMEDIATE POINTS AND ON COMPLETION OF ENDURANCE TESTS**

No.	ESA/SCC GENERIC SPECIFICATION NO. 3202		MEASUREMENTS AND INSPECTIONS		SYMBOL	LIMITS	UNIT
	ENVIRONMENTAL AND ENDURANCE TESTS (1)	TEST METHOD AND CONDITIONS	IDENTIFICATION	CONDITIONS			
01	Rapid Change of Temperature	Para. 9.4	Electrical Measurements Visual Examination	Table 2 -		Table 1(a) -	
02	Vibration	Para. 9.5	Electrical Measurements Visual Examination	Table 2 -		Table 1(a) -	
03	Shock or Bump	Para. 9.16	Electrical Measurements Visual Examination	Table 2 -		Table 1(a) -	
04	Permanence of Marking	Para. 9.17	Visual Examination	-		-	
05	Climatic Sequence Dry Heat Cold Test Low Air Pressure Damp Heat	Para. 9.18 Para. 9.18.2 Para. 9.18.4 Para. 9.18.5 Para. 9.18.6	Electrical Measurements Electrical Measurements 3202, Para. 9.18.5 Electrical Measurements	Table 3 Table 3 - Table 2		Table 1(a) Table 1(a) 3202, Para. 9.18.5 Table 1(a)	
06	Corrosion	Para. 9.19	Visual Examination	-		-	
07	Coupling Proof Torque	Para. 9.8	Interface Dimensions Visual Examination	- -		3402/001 or 002, Figure 2 -	
08	Endurance	Para. 9.20	Mating/Unmating Forces Contact Resistance Visual Examination	3402, Para. 9.18 - -	$R_c$	3402/001 or 002, Table 6 3402/001 or 002, Table 6 -	$m\Omega$
09	Solderability	Para. 9.21	Visual Examination	-		-	
10	Robustness of Terminations	Para. 9.22	Visual Examination	-		-	
11	Seal Test	Para. 9.6	Not applicable	-		-	
12	Damp Heat	Para. 9.23	Electrical Measurements Visual Examination	Table 2 -		Table 1(a) -	
13	Operating Life	Para. 9.24.1 Para. 9.24.4 Para. 9.24.5	Init. Elec. Measurements Inter. Elec. Measurements Final Elec. Measurements	Table 2 Table 2 Table 2		Table 1(a) Table 1(a) Table 1(a)	
14	Mating and Unmating Forces	Para. 9.9	3402/001 or 002, Table 6	-		3402/001 or 002, Table 6	
15	Contact Engagement and Separation Forces	Para. 9.13	3402/001 or 002, Table 6	-		3402/001 or 002, Table 6	

**NOTES**

1. The tests in this table refer to either Chart IV or V and shall be used as applicable.