



**european space agency  
agence spatiale européenne**

Pages 1 to 22

**DIODES, MICROWAVE, SILICON,  
HYPER-ABRUPT JUNCTION TUNING VARACTOR,  
BASED ON TYPES DH733 THRU DH739**

**ESA/SCC Detail Specification No. 5512/022**



**space components  
coordination group**

| Issue/Rev. | Date          | Approved by   |                                       |
|------------|---------------|---------------|---------------------------------------|
|            |               | SCCG Chairman | ESA Director General<br>or his Deputy |
| Issue 1    | December 1998 |               |                                       |
|            |               |               |                                       |
|            |               |               |                                       |
|            |               |               |                                       |





ESA/SCC Detail Specification  
No. 5512/022

PAGE 2

ISSUE 1

**DOCUMENTATION CHANGE NOTICE**

| Rev.<br>Letter | Rev.<br>Date | Reference | CHANGE<br>Item | Approved<br>DCR No. |
|----------------|--------------|-----------|----------------|---------------------|
|                |              |           |                |                     |

|   |   |  |                |
|---|---|--|----------------|
|  |  | <p>ESA/SCC Detail Specification<br/>No. 5512/022</p> | <p>PAGE 3</p>  |
|   |   |  | <p>ISSUE 1</p> |

**TABLE OF CONTENTS**

|   | <u>Page</u> |
|---|-------------|
| <b>1. <u>GENERAL</u></b>  | <b>5</b>    |
| 1.1 Scope   | 5           |
| 1.2 Component Type Variants   | 5           |
| 1.3 Maximum Ratings   | 5           |
| 1.4 Parameter Derating Information  | 5           |
| 1.5 Physical Dimensions   | 5           |
| 1.6 Functional Diagram  | 5           |
| 1.7 Handling Precautions  | 5           |
| <b>2. <u>APPLICABLE DOCUMENTS</u></b>   | <b>5</b>    |
| <b>3. <u>TERMS, DEFINITIONS, ABBREVIATIONS, SYMBOLS AND UNITS</u></b>                     | <b>5</b>    |
| <b>4. <u>REQUIREMENTS</u></b>   | <b>14</b>   |
| 4.1 General   | 14          |
| 4.2 Deviations from Generic Specification   | 14          |
| 4.2.1 Deviations from Production Control  | 14          |
| 4.2.2 Deviations from Final Production Tests  | 14          |
| 4.2.3 Deviations from Burn-in and Electrical Measurements                                 | 14          |
| 4.2.4 Deviations from Qualification Tests   | 14          |
| 4.2.5 Deviations from Lot Acceptance Tests  | 14          |
| 4.3 Mechanical and Environmental Requirements   | 14          |
| 4.3.1 Dimension Check   | 14          |
| 4.3.2 Weight  | 14          |
| 4.3.3 Terminal Strength   | 15          |
| 4.3.4 Bond Strength   | 15          |
| 4.3.5 Die Shear   | 15          |
| 4.4 Materials and Finishes  | 15          |
| 4.4.1 Case  | 15          |
| 4.4.2 Lead Materials and Finish   | 15          |
| 4.5 Marking   | 16          |
| 4.5.1 General   | 16          |
| 4.5.2 Cathode Identification  | 16          |
| 4.5.3 The SCC Component Number  | 16          |
| 4.5.4 Traceability Information  | 16          |
| 4.6 Electrical Measurements   | 16          |
| 4.6.1 Electrical Measurements at Room Temperature   | 16          |
| 4.6.2 Electrical Measurements at High and Low Temperatures                                | 16          |
| 4.7 Burn-in Tests   | 17          |
| 4.7.1 Parameter Drift Values  | 17          |
| 4.7.2 Conditions for High Temperature Reverse Bias Burn-in                                | 17          |
| 4.7.3 Conditions for Power Burn-in  | 17          |
| 4.7.4 Electrical Circuits for High Temperature Reverse Bias Burn-in                       | 17          |
| 4.7.5 Electrical Circuits for Power Burn-in   | 17          |
| 4.8 Environmental and Endurance Tests   | 20          |
| 4.8.1 Electrical Measurements on Completion of Environmental Tests                        | 20          |
| 4.8.2 Electrical Measurements at Intermediate Points and on Completion of Endurance Tests | 20          |
| 4.8.3 Conditions for Operating Life Tests   | 20          |
| 4.8.4 Electrical Circuit for Operating Life Tests   | 20          |
| 4.9 Total Dose Irradiation Testing  | 20          |
| 4.10 Special Testing  | 20          |

**TABLES**

|   | <u>Page</u> |
|---|-------------|
| 1(a) Type Variants  | 6           |
| 1(b) Maximum Ratings  | 8           |
| 2 Electrical Measurements at Room Temperature - D.C. Parameters                         | 18          |
| Electrical Measurements at Room Temperature - A.C. Parameters                           | 18          |
| 3 Electrical Measurements at High and Low Temperatures                                  | 18          |
| 4 Parameter Drift Values  | 19          |
| 5(a) Conditions for High Temperature Reverse Bias Burn-in and Operating Life Tests      | 19          |
| 5(b) Conditions for Power Burn-in   | 19          |
| 6 Electrical Measurements at Intermediate Points and on Completion of Endurance Testing | 21          |
| 7 Electrical Measurements During and on Completion of Irradiation Testing               | N/A         |

**FIGURES**

|  |     |
|--|-----|
| 1 Parameter Derating Information   | 8   |
| 2 Physical Dimensions  | 9   |
| 3 Functional Diagram   | 13  |
| 4 Circuits for Electrical Measurements   | N/A |
| 5(a) Electrical Circuit for High Temperature Reverse Bias Burn-in and Operating Life Tests | 19  |
| 5(b) Electrical Circuit for Power Burn-in  | N/A |
| 6 Bias Conditions for Irradiation Testing  | N/A |

**APPENDICES (Applicable to specific Manufacturers only)**

|                                       |    |
|---------------------------------------|----|
| 'A' Agreed Deviations for TEKELEC (F) | 22 |
|---------------------------------------|----|

**1. GENERAL****1.1 SCOPE**

This specification details the ratings, physical and electrical characteristics, test and inspection data for a Diode, Microwave, Silicon, Hyper-Abrupt Junction Tuning Varactor, based on Types DH733 thru DH739. It shall be read in conjunction with ESA/SCC Generic Specification No. 5010, the requirements of which are supplemented herein.

**1.2 COMPONENT TYPE VARIANTS**

Variants of the basic diodes specified herein, which are also covered by this specification are given in Table 1(a).

**1.3 MAXIMUM RATINGS**

The maximum ratings, which shall not be exceeded at any time during use or storage, applicable to the diodes specified herein, are as scheduled in Table 1(b).

**1.4 PARAMETER DERATING INFORMATION**

The derating information applicable to the diodes specified herein is shown in Figure 1.

**1.5 PHYSICAL DIMENSIONS**

The physical dimensions of the diodes specified herein are shown in Figure 2.

**1.6 FUNCTIONAL DIAGRAM**

The functional diagram, showing lead identification, of the diodes specified herein, is shown in Figure 3.

**1.7 HANDLING PRECAUTIONS**

These devices are susceptible to damage by electrostatic discharge. Therefore, suitable precautions shall be employed for protection during all phases of manufacture, testing, packaging, shipment and any handling.

These components are categorised as Class 2 with a Minimum Critical Path Failure Voltage of 2 500V for Variants 01 to 45 and 55 to 63 and 5 000V for Variants 46 to 54.

**2. APPLICABLE DOCUMENTS**

The following documents form part of this specification and shall be read in conjunction with it:-

- (a) ESA/SCC Generic Specification No. 5010 for Discrete Microwave Semiconductor Components.
- (b) MIL-STD-750, Test Methods for Semiconductor Devices.

**3. TERMS, DEFINITIONS, ABBREVIATIONS, SYMBOLS AND UNITS**

For the purpose of this specification, the terms, definitions, abbreviations, symbols and units specified in ESA/SCC Basic Specification No. 21300 shall apply.



**TABLE 1(a) - TYPE VARIANTS**

| (1)<br>VARIANT | (2)<br>BASED ON<br>TYPE | (3)<br>FIGURE | (4)<br>TOTAL<br>CAPACITANCE<br>C <sub>T</sub> (pF) | (5)<br>TUNING<br>RATIO<br>C <sub>T0</sub> /C <sub>T20</sub> | (6)<br>QUALITY<br>FACTOR<br>(Q) | (7)<br>BODY-LID AND<br>LEAD MATERIAL<br>AND FINISH |
|----------------|-------------------------|---------------|--|---|---------------------------------|--|
| 01             | DH733                   | 2(a)          | 0.74   | 5.0   | 180                             | D7-E2  |
| 02             | DH733                   | 2(b)          | 0.74   | 5.0   | 180                             | D7   |
| 03             | DH733                   | 2(c)          | 0.74   | 5.0   | 180                             | D7-E2  |
| 04             | DH733                   | 2(d)          | 0.74   | 5.0   | 180                             | D7-E2  |
| 05             | DH733                   | 2(e)          | 0.74   | 5.0   | 180                             | D7-E2  |
| 06             | DH733                   | 2(f)          | 0.74   | 5.0   | 180                             | D7-E2  |
| 07             | DH733                   | 2(g)          | 0.80   | 5.0   | 180                             | A7-D7  |
| 08             | DH733                   | 2(h)          | 0.87   | 5.0   | 180                             | D7   |
| 09             | DH733                   | 2(i)          | 0.87   | 5.0   | 180                             | D7-E2  |
| 10             | DH734                   | 2(a)          | 1.14   | 5.0   | 160                             | D7-E2  |
| 11             | DH734                   | 2(b)          | 1.14   | 5.0   | 160                             | D7   |
| 12             | DH734                   | 2(c)          | 1.14   | 5.0   | 160                             | D7-E2  |
| 13             | DH734                   | 2(d)          | 1.14   | 5.0   | 160                             | D7-E2  |
| 14             | DH734                   | 2(e)          | 1.14   | 5.0   | 160                             | D7-E2  |
| 15             | DH734                   | 2(f)          | 1.14   | 5.0   | 160                             | D7-E2  |
| 16             | DH734                   | 2(g)          | 1.20   | 5.0   | 160                             | A7-D7  |
| 17             | DH734                   | 2(h)          | 1.27   | 5.0   | 160                             | D7   |
| 18             | DH734                   | 2(i)          | 1.27   | 5.0   | 160                             | D7-E2  |
| 19             | DH735                   | 2(a)          | 1.74   | 5.0   | 150                             | D7-E2  |
| 20             | DH735                   | 2(b)          | 1.74   | 5.0   | 150                             | D7   |
| 21             | DH735                   | 2(c)          | 1.74   | 5.0   | 150                             | D7-E2  |
| 22             | DH735                   | 2(d)          | 1.74   | 5.0   | 150                             | D7-E2  |
| 23             | DH735                   | 2(e)          | 1.74   | 5.0   | 150                             | D7-E2  |
| 24             | DH735                   | 2(f)          | 1.74   | 5.0   | 150                             | D7-E2  |
| 25             | DH735                   | 2(g)          | 1.80   | 5.0   | 150                             | A7-D7  |
| 26             | DH735                   | 2(h)          | 1.87   | 5.0   | 150                             | D7   |
| 27             | DH735                   | 2(i)          | 1.87   | 5.0   | 150                             | D7-E2  |
| 28             | DH736                   | 2(a)          | 2.64   | 6.0   | 100                             | D7-E2  |
| 29             | DH736                   | 2(b)          | 2.64   | 6.0   | 100                             | D7   |
| 30             | DH736                   | 2(c)          | 2.64   | 6.0   | 100                             | D7-E2  |
| 31             | DH736                   | 2(d)          | 2.64   | 6.0   | 100                             | D7-E2  |
| 32             | DH736                   | 2(e)          | 2.64   | 6.0   | 100                             | D7-E2  |
| 33             | DH736                   | 2(f)          | 2.64   | 6.0   | 100                             | D7-E2  |
| 34             | DH736                   | 2(g)          | 2.70   | 6.0   | 100                             | A7-D7  |
| 35             | DH736                   | 2(h)          | 2.77   | 6.0   | 100                             | D7   |
| 36             | DH736                   | 2(i)          | 2.77   | 6.0   | 100                             | D7-E2  |
| 37             | DH737                   | 2(a)          | 3.84   | 6.0   | 85                              | D7-E2  |
| 38             | DH737                   | 2(b)          | 3.84   | 6.0   | 85                              | D7   |
| 39             | DH737                   | 2(c)          | 3.84   | 6.0   | 85                              | D7-E2  |
| 40             | DH737                   | 2(d)          | 3.84   | 6.0   | 85                              | D7-E2  |
| 41             | DH737                   | 2(e)          | 3.84   | 6.0   | 85                              | D7-E2  |
| 42             | DH737                   | 2(f)          | 3.84   | 6.0   | 85                              | D7-E2  |
| 43             | DH737                   | 2(g)          | 3.90   | 6.0   | 85                              | A7-D7  |
| 44             | DH737                   | 2(h)          | 3.97   | 6.0   | 85                              | D7   |
| 45             | DH737                   | 2(i)          | 3.97   | 6.0   | 85                              | D7-E2  |



**TABLE 1(a) - TYPE VARIANTS**

| (1)<br>VARIANT | (2)<br>BASED ON<br>TYPE | (3)<br>FIGURE | (4)<br>TOTAL<br>CAPACITANCE<br>$C_T$ (pF) | (5)<br>TUNING<br>RATIO<br>$C_{T0}/C_{T20}$ | (6)<br>QUALITY<br>FACTOR<br>(Q) | (7)<br>BODY-LID AND<br>LEAD MATERIAL<br>AND FINISH |
|----------------|-------------------------|---------------|---|--|---------------------------------|--|
| 46             | DH738                   | 2(a)          | 4.64                                      | 6.0  | 70                              | D7-E2  |
| 47             | DH738                   | 2(b)          | 4.64                                      | 6.0  | 70                              | D7   |
| 48             | DH738                   | 2(c)          | 4.64                                      | 6.0  | 70                              | D7-E2  |
| 49             | DH738                   | 2(d)          | 4.64                                      | 6.0  | 70                              | D7-E2  |
| 50             | DH738                   | 2(e)          | 4.64                                      | 6.0  | 70                              | D7-E2  |
| 51             | DH738                   | 2(f)          | 4.64                                      | 6.0  | 70                              | D7-E2  |
| 52             | DH738                   | 2(g)          | 4.70                                      | 6.0  | 70                              | A7-D7  |
| 53             | DH738                   | 2(h)          | 4.77                                      | 6.0  | 70                              | D7   |
| 54             | DH738                   | 2(i)          | 4.77                                      | 6.0  | 70                              | D7-E2  |
| 55             | DH739                   | 2(a)          | 7.87                                      | 6.0  | 10                              | D7-E2  |
| 56             | DH739                   | 2(b)          | 7.87                                      | 6.0  | 10                              | D7   |
| 57             | DH739                   | 2(c)          | 7.87                                      | 6.0  | 10                              | D7-E2  |
| 58             | DH739                   | 2(d)          | 7.87                                      | 6.0  | 10                              | D7-E2  |
| 59             | DH739                   | 2(e)          | 7.87                                      | 6.0  | 10                              | D7-E2  |
| 60             | DH739                   | 2(f)          | 7.87                                      | 6.0  | 10                              | D7-E2  |
| 61             | DH739                   | 2(g)          | 7.93                                      | 6.0  | 10                              | A7-D7  |
| 62             | DH739                   | 2(h)          | 8.0                                       | 6.0  | 10                              | D7   |
| 63             | DH739                   | 2(i)          | 8.0                                       | 6.0  | 10                              | D7-E2  |



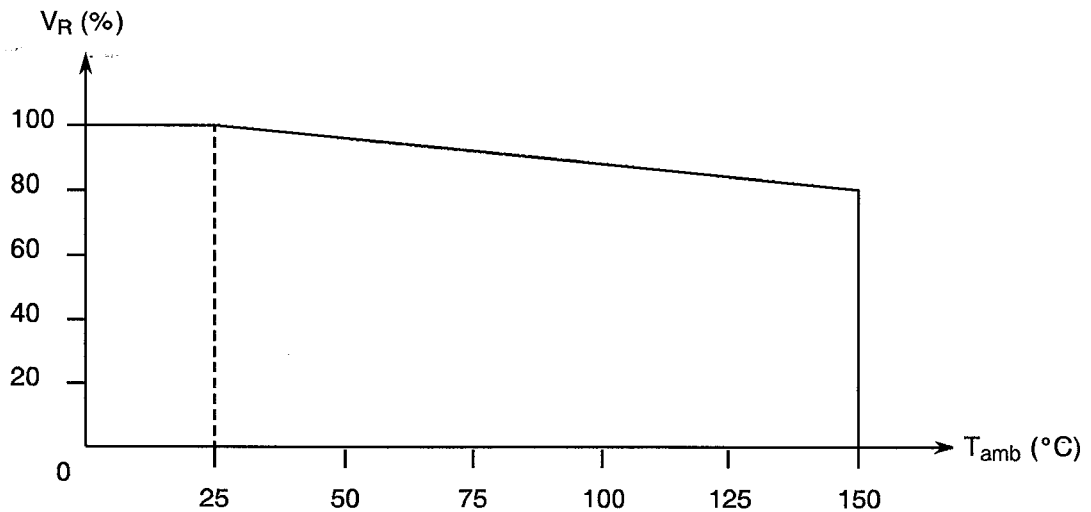
**TABLE 1(b) - MAXIMUM RATINGS**

| No. | CHARACTERISTICS             | SYMBOL    | MAXIMUM RATINGS | UNIT | REMARKS   |
|-----|-----------------------------|-----------|-----------------|------|-----------|
| 1   | Maximum Reverse Voltage     | $V_R$     | - 20            | V    | Note 1    |
| 2   | Operating Temperature Range | $T_{op}$  | - 55 to + 150   | °C   | $T_{amb}$ |
| 3   | Storage Temperature Range   | $T_{stg}$ | - 65 to + 175   | °C   |           |
| 4   | Soldering Temperature       | $T_{sol}$ | + 230           | °C   | Note 2    |

**NOTES**

1. Measured at  $I_R = 10\mu A$  and  $T_{amb} = +25^\circ C$ . For derating at  $T_{amb} > +25^\circ C$ , see Figure 1.
2. Duration 5 seconds maximum at a distance of not less than 1.5mm from the device body and the same termination shall not be resoldered until 3 minutes have elapsed. Not applicable to Variants 02, 07, 08, 11, 16, 17, 20, 25, 26, 29, 34, 35, 38, 43, 44, 47, 52, 53, 56, 61 and 62.

**FIGURE 1 - PARAMETER DERATING INFORMATION**



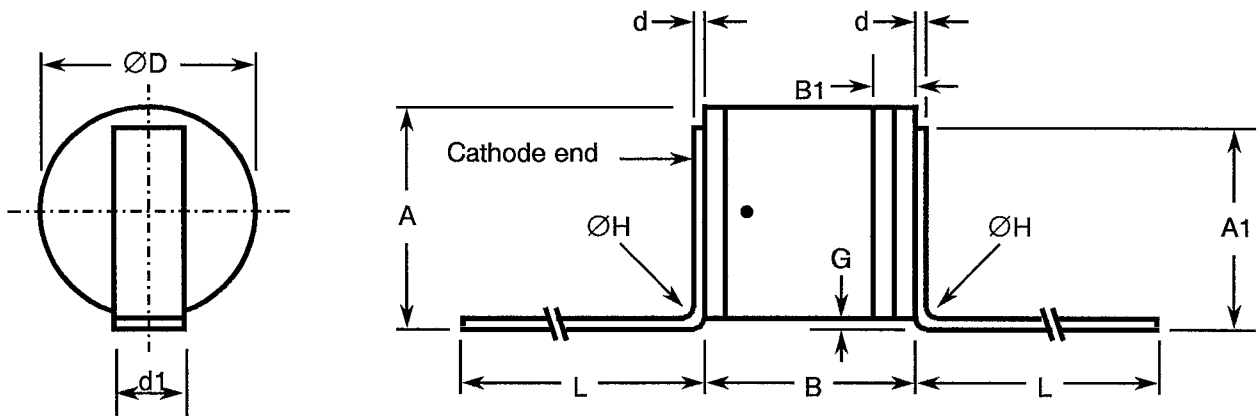
Reverse Voltage versus Temperature



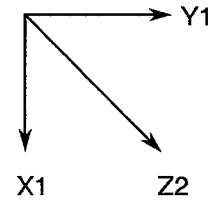


**FIGURE 2 - PHYSICAL DIMENSIONS**

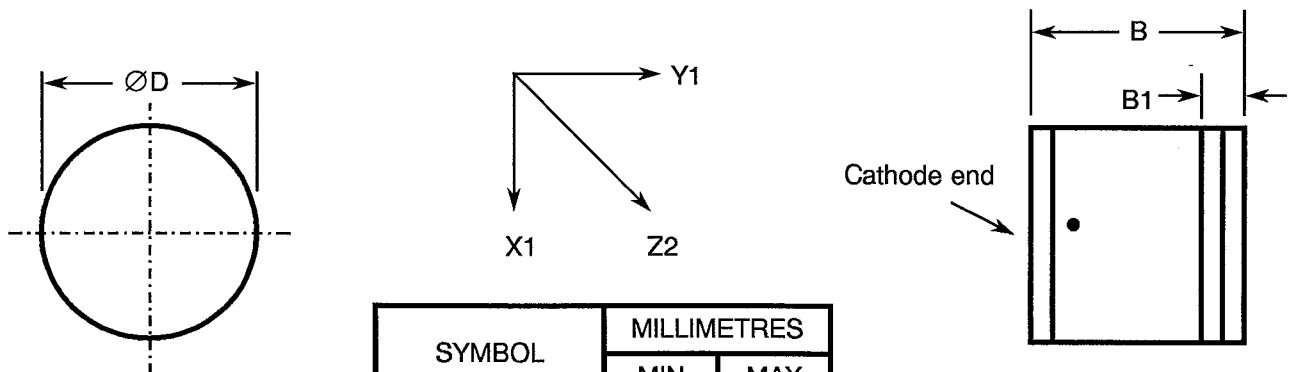
**FIGURE 2(a) - VARIANTS 01, 10, 19, 28, 37, 46, 55**



| SYMBOL | MILLIMETRES |      |
|--------|-------------|------|
|        | MIN.        | MAX. |
| A      | 1.30        | 1.90 |
| A1     | 1.22        | 1.82 |
| B      | 0.95        | 1.35 |
| B1     | 0.23        | 0.33 |
| d      | 0.06        | 0.10 |
| d1     | 0.55        | 0.65 |
| ØD     | 1.07        | 1.47 |
| G      | 0.10        | 0.50 |
| ØH     | 0.10        | 0.50 |
| L      | 2.50        | -    |



**FIGURE 2(b) - VARIANTS 02, 11, 20, 29, 38, 47, 56**



| SYMBOL | MILLIMETRES |      |
|--------|-------------|------|
|        | MIN         | MAX  |
| B      | 0.95        | 1.35 |
| B1     | 0.23        | 0.33 |
| ØD     | 1.07        | 1.47 |



**FIGURE 2 - PHYSICAL DIMENSIONS (CONTINUED)**

FIGURE 2(c) - VARIANTS 03, 12, 21, 30, 39, 48, 57

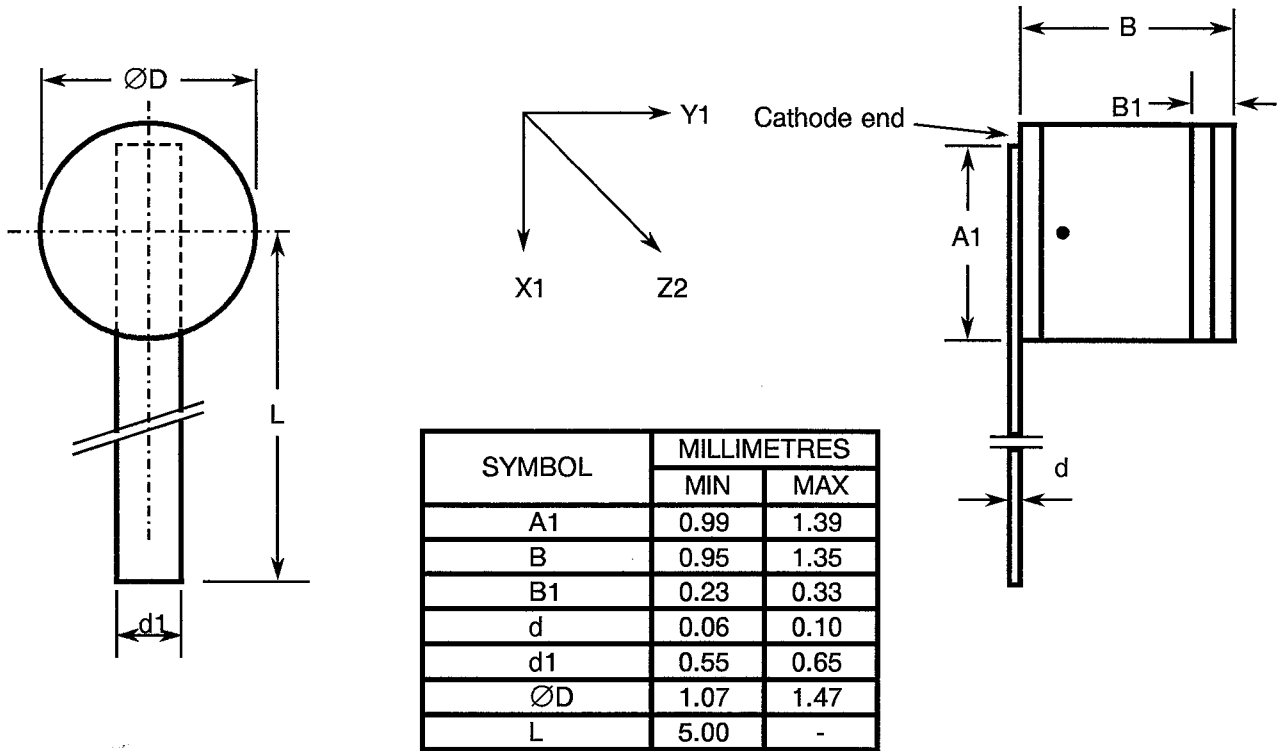
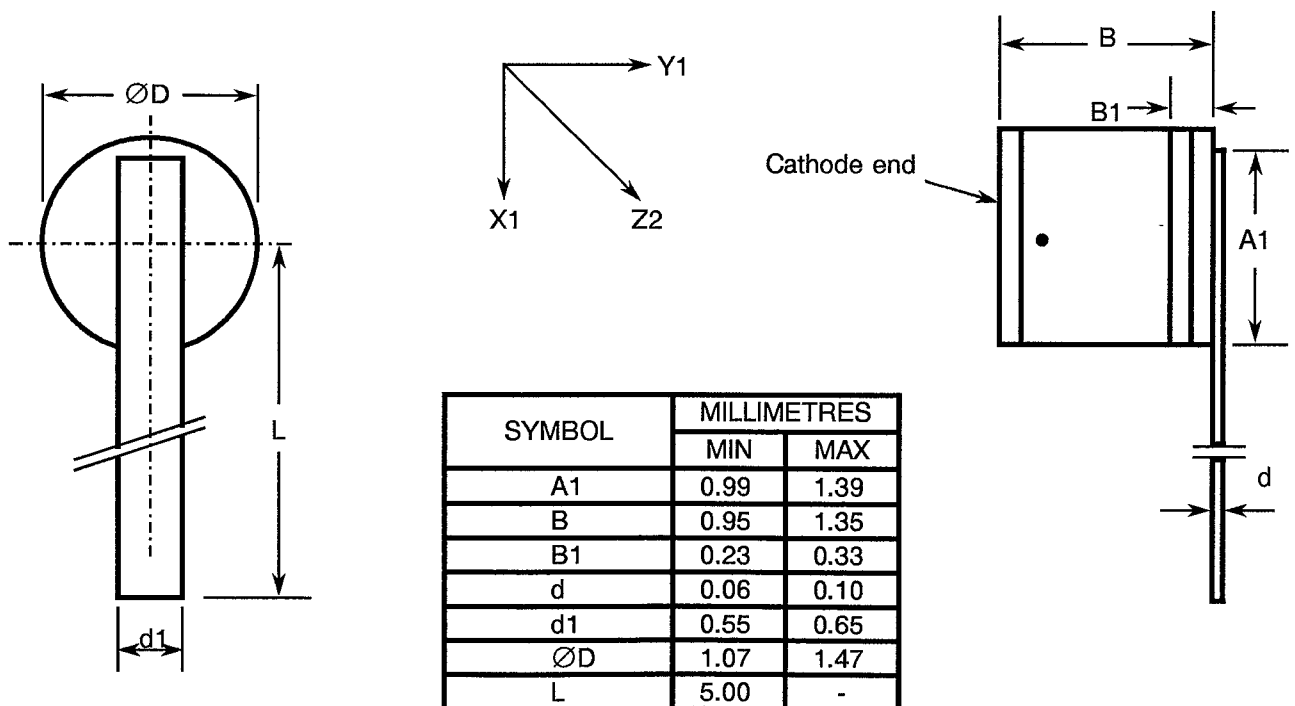


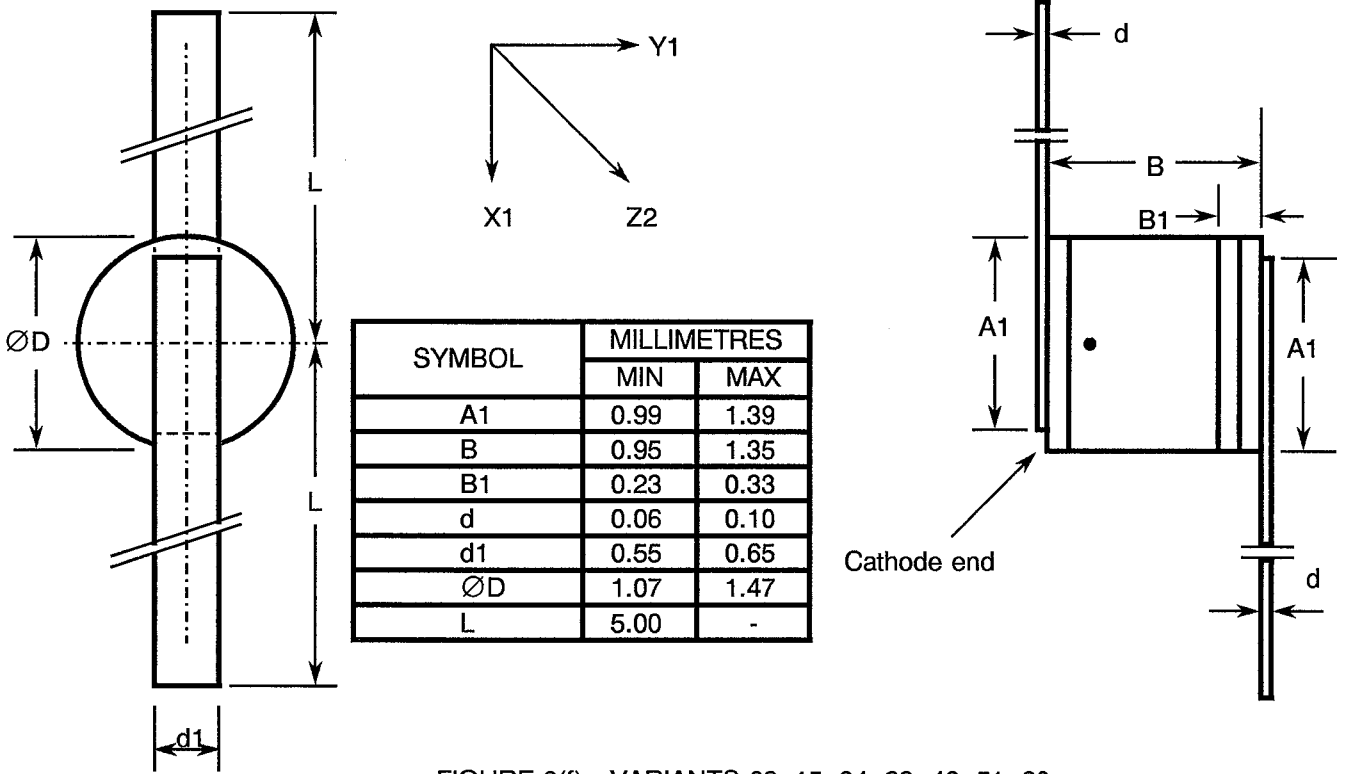
FIGURE 2(d) - VARIANTS 04, 13, 22, 31, 40, 49, 58



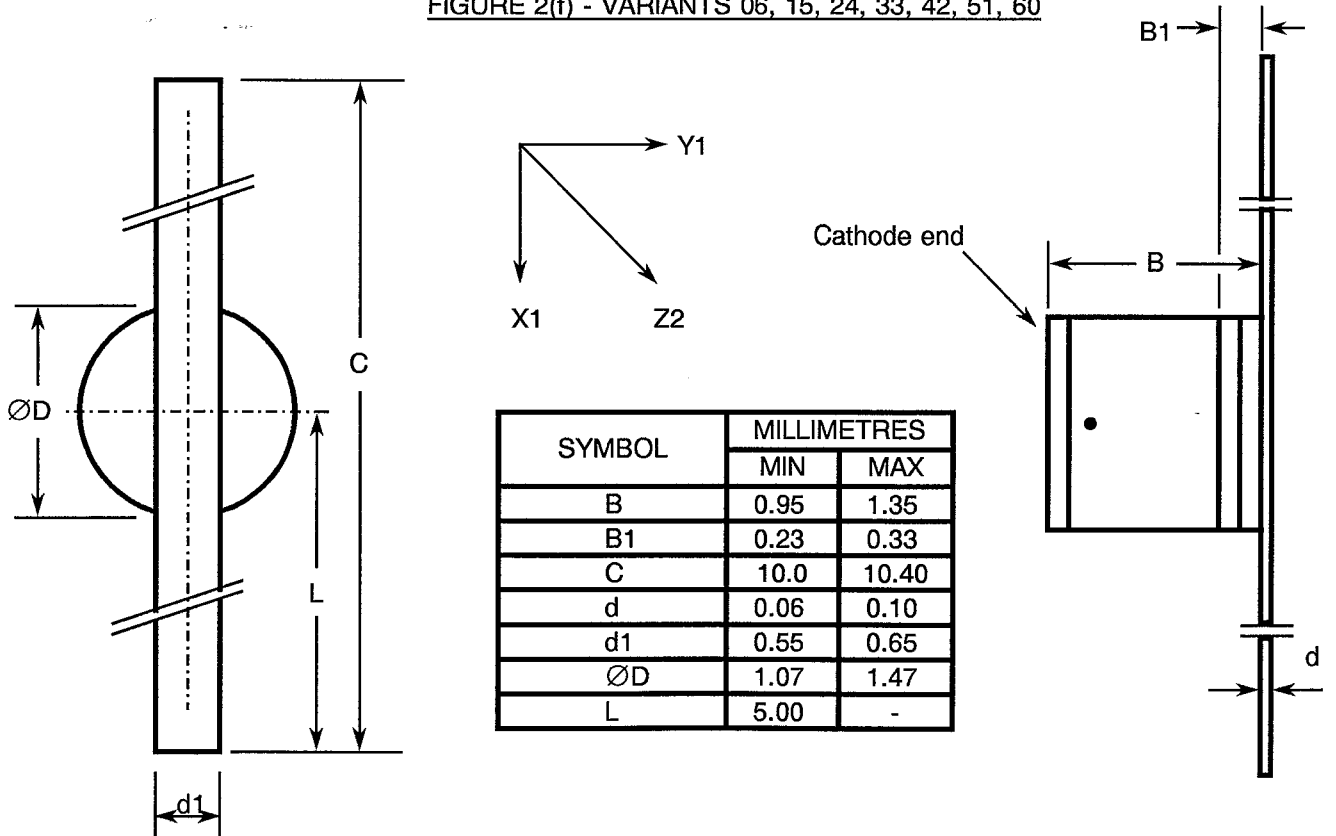


**FIGURE 2 - PHYSICAL DIMENSIONS (CONTINUED)**

**FIGURE 2(e) - VARIANTS 05, 14, 23, 32, 41, 50, 59**



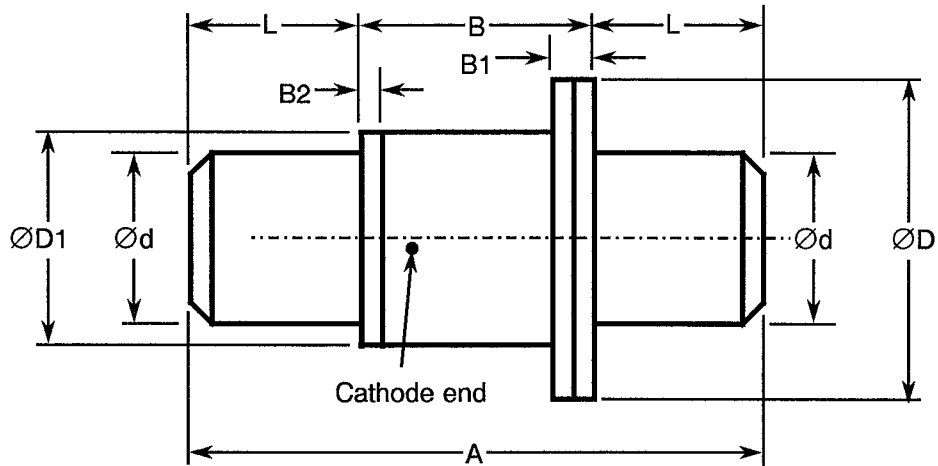
**FIGURE 2(f) - VARIANTS 06, 15, 24, 33, 42, 51, 60**



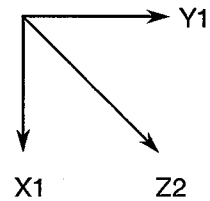


**FIGURE 2 - PHYSICAL DIMENSIONS (CONTINUED)**

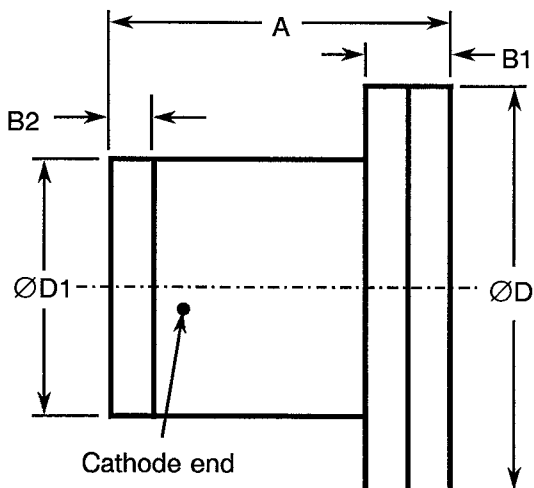
**FIGURE 2(g) - VARIANTS 07, 16, 25, 34, 43, 52, 61**



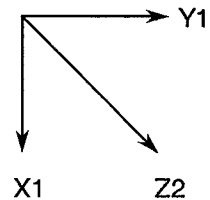
| SYMBOL | MILLIMETRES |      |
|--------|-------------|------|
|        | MIN         | MAX  |
| A      | 5.20        | 5.72 |
| B      | 2.16        | 2.46 |
| B1     | 0.41        | 0.61 |
| B2     | 0.15        | 0.25 |
| Ød     | 1.52        | 1.63 |
| ØD     | 3.00        | 3.23 |
| ØD1    | 1.95        | 2.11 |
| L      | 1.52        | 1.63 |



**FIGURE 2(h) - VARIANTS 08, 17, 26, 35, 44, 53, 62**



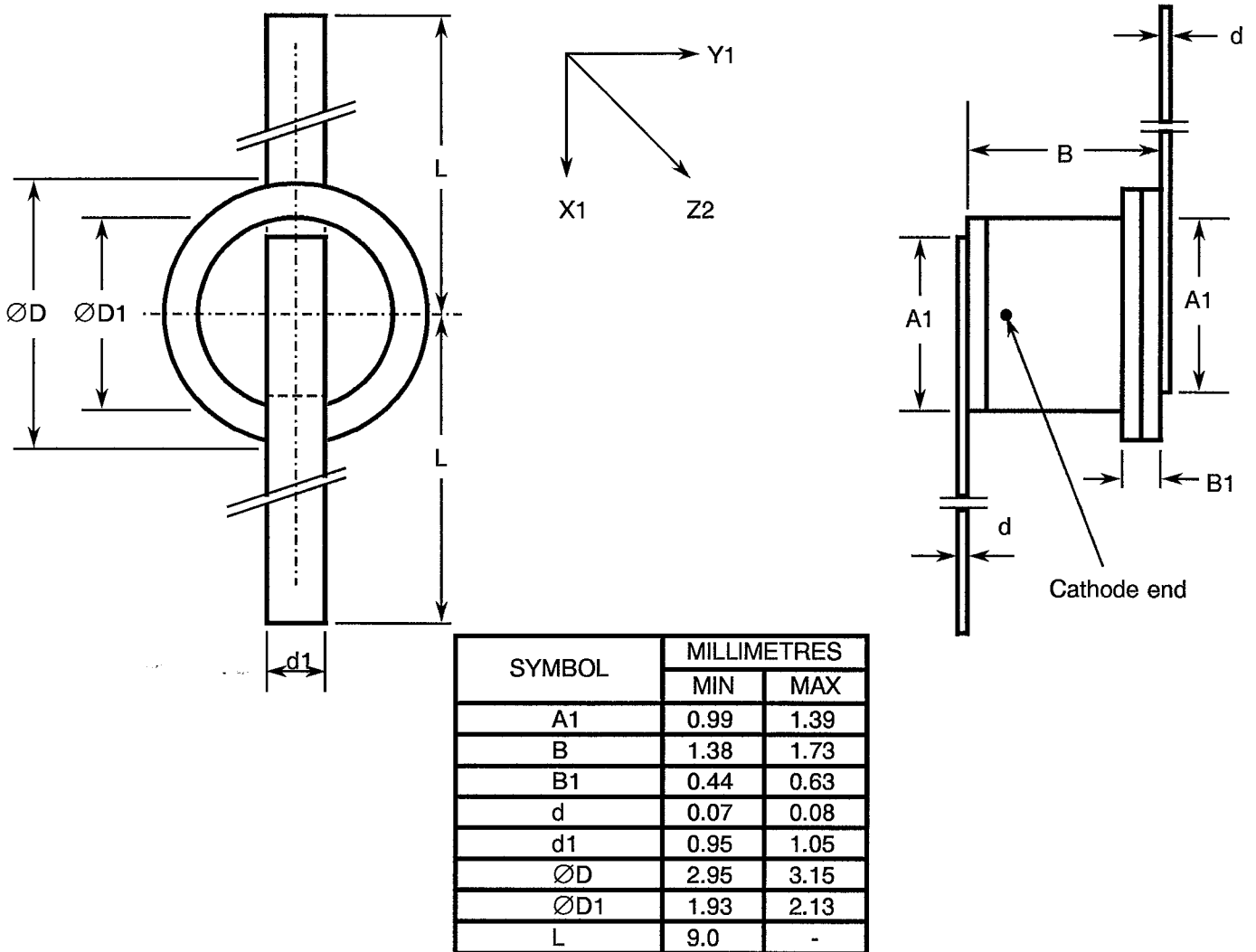
| SYMBOL | MILLIMETRES |      |
|--------|-------------|------|
|        | MIN         | MAX  |
| A      | 1.40        | 1.60 |
| B1     | 0.40        | 0.60 |
| B2     | 0.15        | 0.25 |
| ØD     | 2.94        | 3.14 |
| ØD1    | 1.93        | 2.13 |





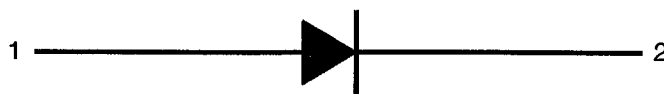
**FIGURE 2 - PHYSICAL DIMENSIONS (CONTINUED)**

**FIGURE 2(i) - VARIANTS 09, 18, 27, 36, 45, 54, 63**



**FIGURE 3 - FUNCTIONAL DIAGRAM**

- 1. Anode
- 2. Cathode





#### 4. REQUIREMENTS

##### 4.1 GENERAL

The complete requirements for procurement of the diodes specified herein shall be as stated in this specification and ESA/SCC Generic Specification No. 5010 for Discrete Microwave Semiconductor Components. Deviations from the Generic Specification applicable to this specification only, are listed in Para. 4.2.

Deviations from the applicable Generic Specification and this Detail Specification, formally agreed with specific Manufacturers on the basis that the alternative requirements are equivalent to the ESA/SCC requirements and do not affect the components' reliability, are listed in the appendices attached to this specification.

##### 4.2 DEVIATIONS FROM GENERIC SPECIFICATION

###### 4.2.1 Deviations from Production Control

None.

###### 4.2.2 Deviations from Final Production Tests (Chart II (b))

None.

###### 4.2.3 Deviations from Burn-in and Electrical Measurements (Chart III)

None.

###### 4.2.4 Deviations from Qualification Tests (Chart IV)

- (a) Para. 9.14, Vibration Test: Shall not be performed.
- (b) Para. 9.15, Constant Acceleration: Shall not be performed.
- (c) Para. 9.19, Terminal Strength: Shall not be performed for Variants 02, 07, 08, 11, 16, 17, 20, 25, 26, 29, 34, 35, 38, 43, 44, 47, 52, 53, 56, 61 and 62.
- (d) Para. 9.23, Special Testing: Shall not be performed.

###### 4.2.5 Deviations from Lot Acceptance Tests (Chart V)

- (a) Para. 9.14, Vibration Test: Shall not be performed.
- (b) Para. 9.15, Constant Acceleration: Shall not be performed.
- (c) Para. 9.19, Terminal Strength: Shall not be performed for Variants 02, 07, 08, 11, 16, 17, 20, 25, 26, 29, 34, 35, 38, 43, 44, 47, 52, 53, 56, 61 and 62.
- (d) Para. 9.23, Special Testing: Shall not be performed.

##### 4.3 MECHANICAL AND ENVIRONMENTAL REQUIREMENTS


###### 4.3.1 Dimension Check

The dimensions of the diodes specified herein shall be checked. They shall conform to those shown in Figure 2.

###### 4.3.2 Weight

The maximum weight of the diodes specified herein shall be as follows:

- Variants 01 to 06, 10 to 15, 19 to 24, 28 to 33, 37 to 42, 46 to 51 and 55 to 60: 0.02g.
- Variants 07, 16, 25, 34, 43, 52 and 61: 0.15g.
- Variants 08, 09, 17, 18, 26, 27, 35, 36, 44, 45, 53, 54, 62 and 63.: 0.06g.

|   |  |  |                    |
|---|--|--|--------------------|
|  | ESA/SCC Detail Specification<br>No. 5512/022 |  | PAGE 15<br>ISSUE 1 |
|---|--|--|--------------------|

#### 4.3.3 Terminal Strength

The requirements for terminal strength are specified in Section 9 of ESA/SCC Generic Specification No. 5010. The test conditions shall be as follows:-

(a) **Condition:** 'A' (Tension).

Variants 01, 03 to 06, 09, 10, 12 to 15, 18, 19, 21 to 24, 27, 28, 30 to 33, 36, 37, 39 to 42, 45, 46, 48 to 51, 54, 55, 57 to 60 and 63.

- Force: 1.25N
- Duration: 10 seconds.

#### 4.3.4 Bond Strength

The requirements for bond strength are specified in Section 9 of ESA/SCC Generic Specification No. 5010. The test conditions shall be as follows:-

(a) **Condition:** 'A'.

#### 4.3.5 Die Shear

The requirements for die shear are specified in Section 9 of ESA/SCC Generic Specification No. 5010.

### 4.4 MATERIALS AND FINISHES

The materials and finishes shall be as specified herein. Where a definite material is not specified, a material which will enable the diodes specified herein to meet the performance requirements of this specification shall be used. Acceptance or approval of any constituent material shall not guarantee acceptance of the finished product.

#### 4.4.1 Case

The case shall be hermetically sealed and have a ceramic body. The lid shall be welded or preform soldered.

#### 4.4.2 Lead Materials and Finish

- (a) For Variants 01, 03 to 06, 09, 10, 12 to 15, 18, 19, 21 to 24, 27, 28, 30 to 33, 36, 37, 39 to 42, 45, 46, 48 to 51, 54, 55, 57 to 60 and 63, the body material shall be Type 'D' with Type '7' finish and the lid material shall be Type 'E' with Type '2' finish, in accordance with the requirements of ESA/SCC Basic Specification No. 23500.
- (b) For Variants 02, 08, 11, 17, 20, 26, 29, 35, 38, 44, 47, 53, 56 and 62, the body and lid material shall be Type 'D' with Type '7' finish, in accordance with the requirements of ESA/SCC Basic Specification No. 23500.
- (c) For Variants 07, 16, 25, 34, 43, 52 and 61, the body material shall be Type 'A' with Type '7' finish and the lid material shall be Type 'D' with Type '7' finish, in accordance with the requirements of ESA/SCC Basic Specification No. 23500.

4.5 MARKING

4.5.1 General

The marking of all components delivered to this specification shall be in accordance with the requirements of ESA/SCC Basic Specification No. 21700 and the following paragraphs. When the component is too small to accommodate all of the marking specified, as much as space permits shall be marked and the marking information, in full, shall accompany the component in its primary package.

The information to be marked and the order of precedence, shall be as follows:-

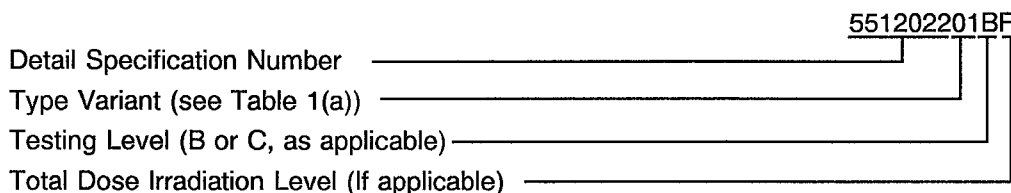
- (a) Cathode Identification.
- (b) The SCC Component Number.
- (c) Traceability Information.

4.5.2 Cathode Identification

Cathode identification shall be as shown in Figures 2 and 3 of this specification.

4.5.3 The SCC Component Number

Each component shall bear the SCC Component Number which shall be constituted and marked as follows:



The Total Dose Irradiation Level designation shall be added for those devices for which a sample has been successfully tested to the level in question. For these devices, a code letter shall be added in accordance with the requirements of ESA/SCC Basic Specification No. 22900.

4.5.4 Traceability Information

Each component shall be marked in respect of traceability information as defined in ESA/SCC Basic Specification No. 21700.

4.6 ELECTRICAL MEASUREMENTS

4.6.1 Electrical Measurements at Room Temperature

The parameters to be measured at room temperature are scheduled in Table 2. Unless otherwise specified, the measurements shall be performed at  $T_{amb} = +22 \pm 3$  °C.

4.6.2 Electrical Measurements at High and Low Temperatures

The parameters to be measured at high and low temperatures are scheduled in Table 3. Unless otherwise specified, the measurements shall be performed at  $+150(+0-3)$  °C.





#### 4.7 BURN-IN TESTS

Burn-in shall be Category 1 of Chart III(a).

##### 4.7.1 Parameter Drift Values

The parameter drift values applicable to burn-in are specified in Table 4 of this specification. Unless otherwise stated, the measurements shall be performed at  $T_{amb} = +22 \pm 3$  °C. The parameter drift values ( $\Delta$ ) applicable to the scheduled parameters shall not be exceeded. In addition to these drift value requirements for a given parameter, the appropriate limit value specified in Table 2 shall not be exceeded.

##### 4.7.2 Conditions for High Temperature Reverse Bias Burn-in

The requirements for the high temperature reverse bias burn-in are specified in Section 9 of ESA/SCC Generic Specification No. 5010. The conditions for high temperature reverse bias burn-in shall be as specified in Table 5(a) of this specification.

##### 4.7.3 Conditions for Power Burn-in

The requirements for power burn-in are specified in Section 9 of ESA/SCC Generic Specification No. 5010. The conditions for power burn-in shall be as specified in Table 5(b) of this specification.

##### 4.7.4 Electrical Circuits for High Temperature Reverse Bias Burn-in

Circuits for use in performing the high temperature reverse bias burn-in test are shown in Figure 5(a) of this specification.

##### 4.7.5 Electrical Circuits for Power Burn-in (Figure 5(b))

Not applicable.

**TABLE 2 - ELECTRICAL MEASUREMENTS AT ROOM TEMPERATURE - D.C. PARAMETERS**

| No. | CHARACTERISTICS   | SYMBOL   | MIL-STD-750<br>TEST METHOD | TEST CONDITIONS | LIMITS |      | UNIT    |
|-----|-------------------|----------|----------------------------|-----------------|--------|------|---------|
|     |                   |          |                            |                 | MIN.   | MAX. |         |
| 1   | Reverse Current 1 | $I_{R1}$ | 4016                       | $V_R = -20V$    | -      | 10   | $\mu A$ |
| 2   | Reverse Current 2 | $I_{R2}$ | 4016                       | $V_R = -16V$    | -      | 50   | nA      |
| 3   | Forward Voltage   | $V_F$    | 4011                       | $I_F = 10mA$    | -      | 1.0  | V       |

**TABLE 2 - ELECTRICAL MEASUREMENTS AT ROOM TEMPERATURE - A.C. PARAMETERS**

| No. | CHARACTERISTICS   | SYMBOL           | MIL-STD-750<br>TEST METHOD | TEST CONDITIONS                                      | LIMITS |        | UNIT |
|-----|-------------------|------------------|----------------------------|--|--------|--------|------|
|     |                   |                  |                            |  | MIN.   | MAX.   |      |
| 4   | Total Capacitance | $C_T$            | 4001                       | $V_R = -6.0V$<br>$f = 1.0MHz$                        | -      | Note 1 | pF   |
| 5   | Tuning Ratio      | $C_{T0}/C_{T20}$ | 4001                       | $V_R = 0V$<br>$V_R = -20V$<br>$f = 1.0MHz$<br>Note 2 | Note 3 | -      | -    |
| 6   | Quality Factor    | Q                | -                          | $V_R = -6.0V$<br>$f = 1.0GHz$                        | Note 4 | -      | -    |

**NOTES**

1. See Column 4 of Table 1(a).
2. Ratio =  $\frac{C_T \text{ at } V_R = 0V}{C_T \text{ at } V_R = -20V}$
3. See Column 5 of Table 1(a).
4. See Column 6 of Table 1(a). Guaranteed but not tested.

**TABLE 3 - ELECTRICAL MEASUREMENTS AT HIGH AND LOW TEMPERATURES**

| No. | CHARACTERISTICS   | SYMBOL   | SPEC. AND/OR<br>TEST METHOD | TEST CONDITIONS | LIMITS |      | UNIT    |
|-----|-------------------|----------|-----------------------------|-----------------|--------|------|---------|
|     |                   |          |                             |                 | MIN.   | MAX. |         |
| 2   | Reverse Current 2 | $I_{R2}$ | 4016                        | $V_R = -16V$    | -      | 10   | $\mu A$ |

**FIGURE 4 - CIRCUITS FOR ELECTRICAL MEASUREMENTS**

Not applicable.



**TABLE 4 - PARAMETER DRIFT VALUES**

| No. | CHARACTERISTICS   | SYMBOL   | SPEC.AND/OR TEST METHOD | TEST CONDITIONS | CHANGE LIMITS ( $\Delta$ )      | UNIT        |
|-----|-------------------|----------|-------------------------|-----------------|---------------------------------|-------------|
| 2   | Reverse Current 2 | $I_{R2}$ | As per Table 2          | As per Table 2  | $\pm 100$<br>or (1)<br>$\pm 10$ | %<br><br>nA |
| 3   | Forward Voltage   | $V_F$    | As per Table 2          | As per Table 2  | $\pm 5.0$                       | %           |
| 4   | Total Capacitance | $C_T$    | As per Table 2          | As per Table 2  | $\pm 5.0$ (2)                   | %           |

**NOTES**

1. Whichever is greater, referred to the initial measurement.
2. Rounded upwards to the nearest 0.01pF. If  $C_T < 0.25\text{pF}$ , then  $\Delta = \pm 10\%$ .

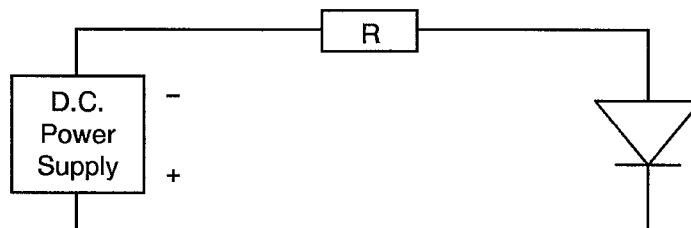
**TABLE 5(a) - CONDITIONS FOR HIGH TEMPERATURE REVERSE BIAS BURN-IN AND OPERATING LIFE TESTS**

| No. | CHARACTERISTICS     | SYMBOL    | CONDITIONS   | UNIT               |
|-----|---------------------|-----------|--|--------------------|
| 1   | Ambient Temperature | $T_{amb}$ | + 150(- 0 + 3)   | $^{\circ}\text{C}$ |
| 2   | Reverse Voltage     | $V_R$     | - 16   | V                  |
| 3   | Duration            | t         | For Testing Level 'B': 240(+ 8 - 0)<br>For Testing Level 'C': 168(+ 8 - 0) | Hours              |

**TABLE 5(b) - CONDITIONS FOR POWER BURN-IN**


| No. | CHARACTERISTICS     | SYMBOL    | CONDITIONS     | UNIT               |
|-----|---------------------|-----------|----------------|--------------------|
| 1   | Ambient Temperature | $T_{amb}$ | + 125(- 0 + 3) | $^{\circ}\text{C}$ |
| 2   | Forward Current     | $I_F$     | 50             | mA                 |
| 3   | Duration            | t         | 48(+ 8 - 0)    | Hours              |

**FIGURE 5(a) - ELECTRICAL CIRCUIT FOR HIGH TEMPERATURE REVERSE BIAS BURN-IN AND OPERATING LIFE TESTS**



**FIGURE 5(b) - ELECTRICAL CIRCUIT FOR POWER BURN-IN**

Not applicable.

|   |  |  |                            |
|---|--|--|----------------------------|
|  | <p style="text-align: center;">ESA/SCC Detail Specification<br/>No. 5512/022</p> |  | <p>PAGE 20<br/>ISSUE 1</p> |
|---|--|--|----------------------------|

4.8 ENVIRONMENTAL AND ENDURANCE TESTS (CHARTS IV AND V OF ESA/SCC GENERIC SPECIFICATION NO. 5010)

4.8.1 Electrical Measurements on Completion of Environmental Tests

The parameters to be measured on completion of environmental tests are scheduled in Table 2. Unless otherwise stated, the measurements shall be performed at  $T_{amb} = +22 \pm 3$  °C.

4.8.2 Electrical Measurements at Intermediate Points and on Completion of Endurance Tests

The parameters to be measured at intermediate points and on completion of endurance tests are scheduled in Table 6. Unless otherwise stated, the measurements shall be performed at  $T_{amb} = +22 \pm 3$  °C.

4.8.3 Conditions for Operating Life Tests (Part of Endurance Testing)

The requirements for operating life testing are specified in Section 9 of ESA/SCC Generic Specification No. 5010. The conditions for operating life testing are specified in Table 5(a) of this specification, except that the duration shall be as specified in ESA/SCC Generic Specification No. 5010, Para. 9.20.

4.8.4 Electrical Circuit for Operating Life Tests

The circuit to be used for performance of the operating life tests shall be the same as shown in Figure 5(a) for high temperature reverse bias burn-in.

4.9 TOTAL DOSE IRRADIATION TESTING

Not applicable.

4.10 SPECIAL TESTING

Not applicable.



**TABLE 6 - ELECTRICAL MEASUREMENTS AT INTERMEDIATE POINTS AND ON COMPLETION OF ENDURANCE TESTING**

| No. | CHARACTERISTICS   | SYMBOL   | SPEC. AND/OR TEST METHOD | TEST CONDITIONS | LIMITS |        | UNIT    |
|-----|-------------------|----------|--------------------------|-----------------|--------|--------|---------|
|     |                   |          |                          |                 | MIN.   | MAX.   |         |
| 1   | Reverse Current 2 | $I_{R2}$ | As per Table 2           | As per Table 2  | -      | 20     | $\mu$ A |
| 2   | Total Capacitance | $C_T$    | As per Table 2           | As per Table 2  | -      | Note 1 | pF      |
| 3   | Forward Voltage   | $V_F$    | As per Table 2           | As per Table 2  | -      | 1.0    | V       |

**NOTES**


1. See Column 4 of Table 1(a).

**FIGURE 6 - BIAS CONDITIONS FOR IRRADIATION TESTING**

Not applicable.

**TABLE 7 - ELECTRICAL MEASUREMENTS DURING AND ON COMPLETION OF IRRADIATION TESTING**

Not applicable.

|   |  |  |                            |
|---|--|--|----------------------------|
|  | <p>ESA/SCC Detail Specification<br/>No. 5512/022</p> |  | <p>PAGE 22<br/>ISSUE 1</p> |
|---|--|--|----------------------------|

**APPENDIX 'A'**

Page 1 of 1

**AGREED DEVIATIONS FOR TEKELEC (F)**

| ITEMS AFFECTED | DESCRIPTION OF DEVIATIONS   |
|----------------|---|
| Para. 4.2.2    | Para. 9.12, Radiographic Inspection of Chart III(a): May be performed after Para. 9.7, PIND test. |
| Para. 4.2.3    | Para. 9.12, Radiographic Inspection: May be performed after Para. 9.7, PIND test of Chart II(b).  |