



europaean space agency  
agence spatiale européenne

Pages 1 to 19

**RADIOGRAPHIC INSPECTION OF  
CAPACITORS**

**ESA/SCC Basic Specification No. 2093000**



**space components  
coordination group**

Issue/Rev.	Date	Approved by	
		SCCG Chairman	ESA Director General or his Deputy
Issue 1	September 1994	<i>P. Monnier</i>	<i>J. H. ...</i>



**SCC**


ESA/SCC Basic Specification  
No. 2093000

PAGE 2

ISSUE 1

**DOCUMENTATION CHANGE NOTICE**

Rev. Letter	Rev. Date	Reference	CHANGE Item	Approved DCR No.

 <b>SCC</b>	ESA/SCC Basic Specification No. 2093000		PAGE 3 ISSUE 1
--	--	--	-------------------

**TABLE OF CONTENTS**

		<u>Page</u>
1.	<b><u>SCOPE</u></b>	<b>4</b>
2.	<b><u>GENERAL REQUIREMENTS</u></b>	<b>4</b>
2.1	Applicability	4
2.2	Procedure	4
3.	<b><u>X-RAY PHOTOGRAPHS</u></b>	<b>4</b>
4.	<b><u>DETAILED REQUIREMENTS</u></b>	<b>7</b>
4.1	Reject Criteria	7
4.2	<b>Ceramic Capacitors</b>	<b>7</b>
4.2.1	Moulding or Coating	7
4.2.2	Terminal Lead Defects	7
4.3	<b>Tantalum Capacitors</b>	<b>9</b>
4.3.1	Tantalum Solid Capacitors	9
4.3.2	Tantalum Non-Solid Capacitors	14
4.3.3	Hermetically sealed Tantalum Foil Capacitors	16
4.4	<b>Plastic Capacitors</b>	<b>18</b>
4.5	<b>Mica Capacitors</b>	<b>19</b>
4.6	<b>Filter Capacitors</b>	<b>19</b>
 <b><u>FIGURES</u></b>		
I	COMPONENT/EXPOSURE ORIENTATION	4
II	APPEARANCE OF A TYPICAL AXIAL PLASTIC CAPACITOR	6
III	UNACCEPTABLE ITEMS FOR CERAMIC CAPACITORS	8
IV	ACCEPTABLE AND UNACCEPTABLE ITEMS FOR TANTALUM SOLID CAPACITORS	11
V	ACCEPTABLE AND UNACCEPTABLE ITEMS FOR TANTALUM NON-SOLID CAPACITORS	14
VI	ACCEPTABLE AND UNACCEPTABLE ITEMS FOR HERMETICALLY SEALED TANTALUM FOIL CAPACITORS	16
VII	UNACCEPTABLE ITEMS FOR PLASTIC CAPACITORS	18
VIII	UNACCEPTABLE ITEMS FOR MICA CAPACITORS	19

**1. SCOPE**

This specification, to be read in conjunction with ESA/SCC Basic Specification No. 20900, Radiographic Inspection, contains additional requirements for capacitors which shall be applied to each device.

**2. GENERAL REQUIREMENTS****2.1 APPLICABILITY**

The following criteria may not be varied or modified after commencement of any inspection stage. Any ambiguity or proposed minor deviation shall be referred to the Qualifying Space Agency for resolution and approval.

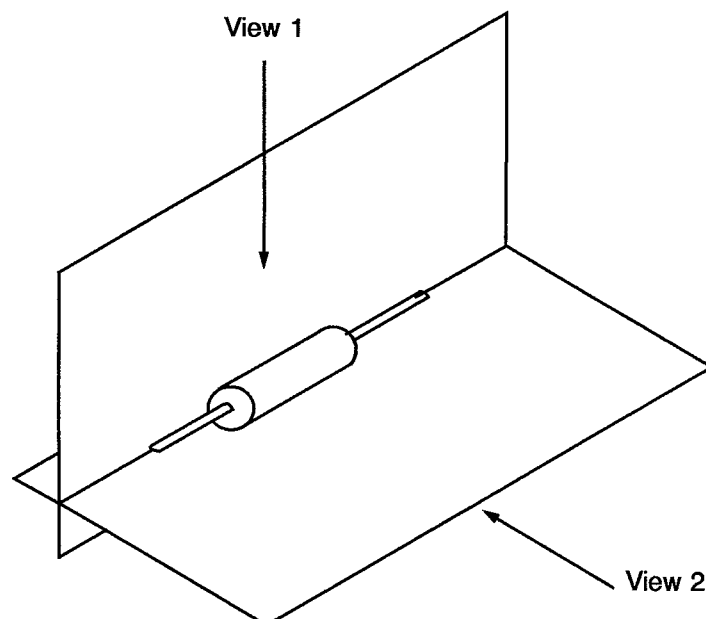
**2.2 PROCEDURE**

All items shall be examined in such a manner that a minimum of handling and movement of the components is involved.

**3. X-RAY PHOTOGRAPHS**

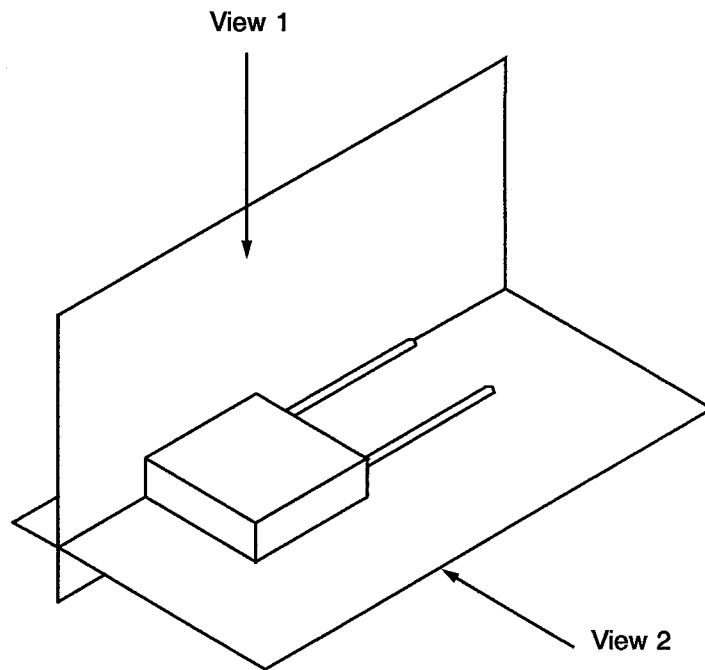
Each component shall be radiographed once in the directions shown in Figure I.

Figure II shows the appearance of a typical axial plastic capacitor.

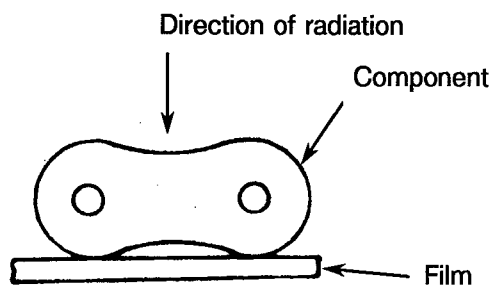
**FIGURE I - COMPONENT/EXPOSURE ORIENTATION****AXIAL LEADS (FOR CERAMIC, TANTALUM, PLASTIC AND FILTER CAPACITORS)**



RADIAL LEADS (FOR CERAMIC AND PLASTIC CAPACITORS)

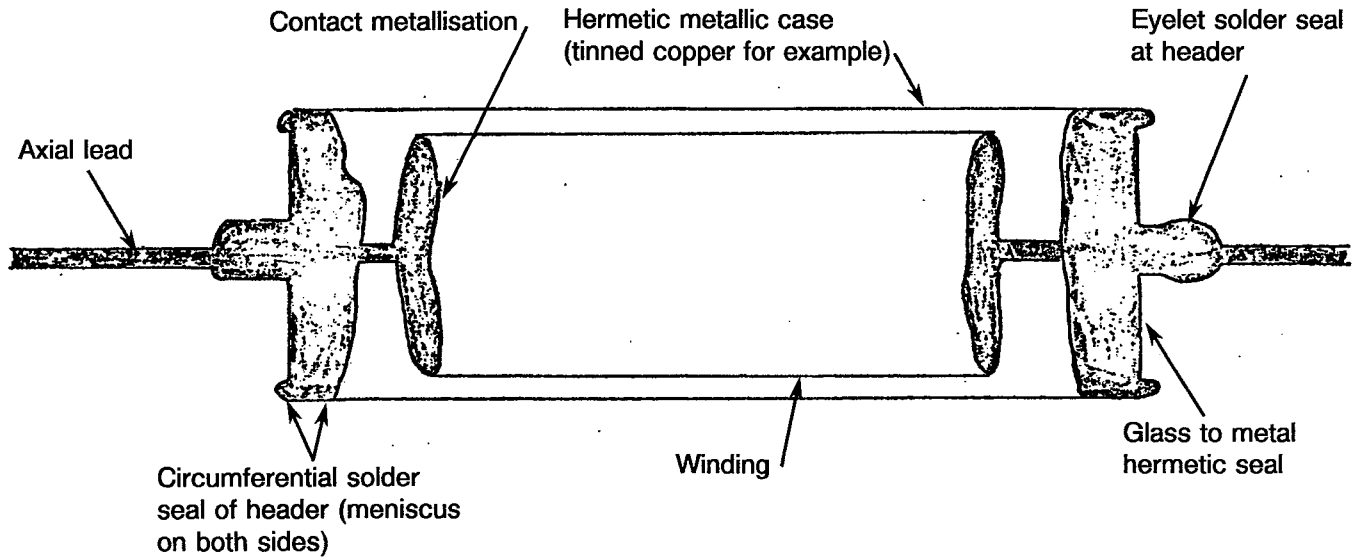


VIEW FOR MICA CAPACITORS





**FIGURE II - APPEARANCE OF A TYPICAL AXIAL PLASTIC CAPACITOR**



**4. DETAILED REQUIREMENTS****4.1 REJECT CRITERIA**

A component shall be rejected if it exhibits one or more of the defects listed in any of the following paragraphs.

The drawings of Figure III are included to provide additional explanatory material, but they shall be considered as examples only.

**4.2 CERAMIC CAPACITORS****4.2.1 Moulding or Coating**

- (a) Thickness of coating or moulding not meeting the requirements of the approved Process Identification Documentation (see Figures III(a) and III(b));
- (b) Capacitor element tilted more than 10° (see Figures III(a), III(b) and III(d));
- (c) Encapsulated foreign material (see Figures III(b) and III(d));
- (d) Cracks, chip-outs or holes (see Figure III(b)).

**4.2.2 Terminal Lead Defects**

- (e) Gaps between lead and ceramic slug larger than 20% of the soldering interface (see Figure III(c));
- (f) Gaps larger than 20% of the lead nail head diameter 'B' (see Figure III(d));
- (g) Contact length 'K' between terminal lead and ceramic slug less than 75% of the body length (see Figures III(a) and III(c));
- (h) Solder spikes exceeding ceramic slug by more than 0.2mm (see Figures III(a) and III(d));
- (i) Cracks visible between wire and ceramic body (see Figures III(c) and III(d)).



**FIGURE III - UNACCEPTABLE ITEMS FOR CERAMIC CAPACITORS**

FIGURE III(a)

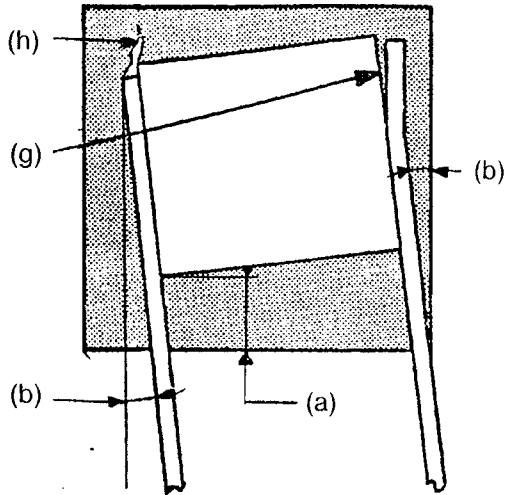


FIGURE III(b)

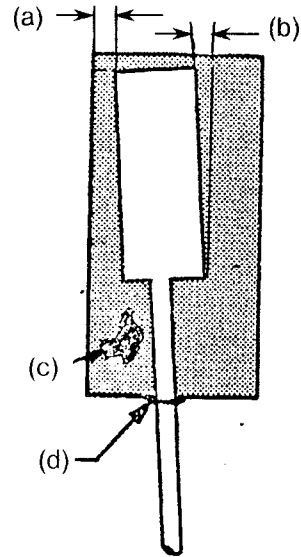


FIGURE III(c)

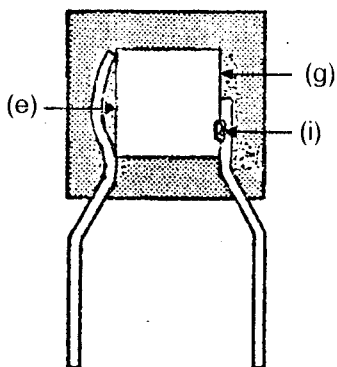
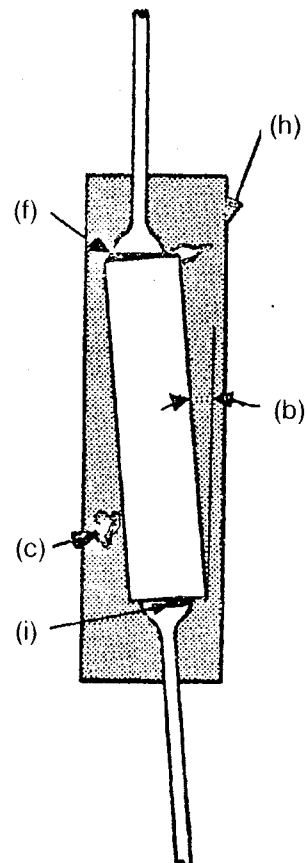




FIGURE III(d)



**NOTES**

1. References (a) to (i) inclusive relate to Paras. 4.2.1 and 4.2.2.



 	<p>ESA/SCC Basic Specification No. 2093000</p>	<p>PAGE 9 ISSUE 1</p>
--	--	---------------------------

#### 4.3 TANTALUM CAPACITORS

##### 4.3.1 Tantalum Solid Capacitors

(a) **Insufficient Solder**

Coverage of only one side and part of another. Illustration shows that lower left corner of slug base is not covered.

(b) **Solder Ball**

Round and dense in appearance. If adhered to case, it will appear to move when second view is taken. If loose, it will probably roll to lower side of can and appear in the same area as it did in first view. Reject 10 mils or larger.

(c) **Stressed Lead**

Bent during assembly; could cause damage to dielectric at vulnerable lead-slug junction.

(d) **Low Solder**

Usually the result of too small a solder preform.

(e) **Poor Splice Weld**

Welds shall be uniform and smooth as well as aligned with the leads.

(f) **Cocked Sealing Area**

The glass cover shall not be in contact with the tantalum slug.

(g) **Cocked Slug**

Upper shoulder of slug touching inside wall of case and anode lead bent near slug.

(h) **Header Solder Flow**

Excess solder flow is indicated by a very dense image along the lower edge of the solder, but feathered along the area closest to the header. To be rejected when flow area approaches top shoulder of slug.

(i) **Excessive Solder**

Either the upper portion of the slug or the anode lead is obscured by solder.

(j) **Insufficient Solder**

Extreme case of insufficient solder indicating marginal bond to case.

(k) **Broken Lead Weld**

Could also indicate poor quality weld.

(l) **No Solder in Case**

Slug may be on bottom of case due to lack of solder preform during manufacture.

(m) **High Slug**

Slug "floating" on solder; may be touching header with inadequate solder tubelet closure above lead weld.

**(n) Particles**

Any irregular particle or pattern of particles exceeding 0.25mm diameter.

**(o) No Tubelet Solder**

Electrical performance during test may be alright. Normally, tubelet is sealed by hand and this operation could be overlooked.

**(p) Solder within Tubelet less than 25%**

Normally, a tubelet is filled for 25 to 50% with high temperature solder. Because the filling is done by hand, quantity of solder may vary lot to lot.

**(q) Capped Fillet**

Under external visual inspection, hollow configurations may have a normal appearance. X-ray inspection, however, may reveal the presence of only a bubble of solder. Reject if inner surface of bubble is above the top of the tubelet or if its cross-sectional thickness is equal to, or less than, the thickness of the tubelet wall.

**(r) Excess Fillet**

Solder extends below bottom of tubelet.

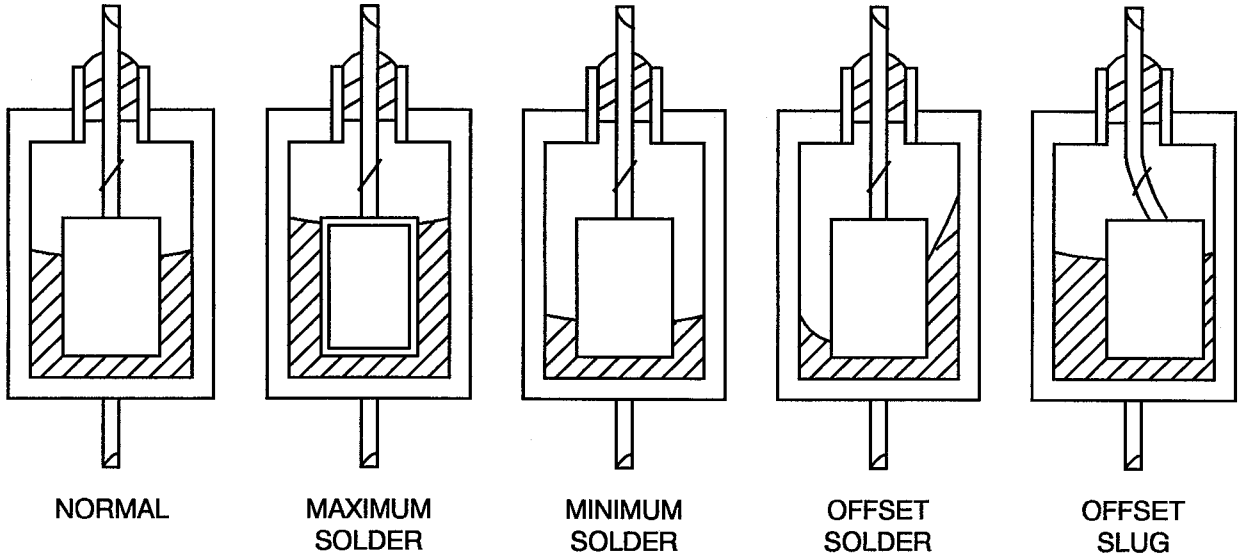
**(s) Reflow**

Tubelet solder shows concave meniscus; solder has flowed down from the tubelet along anode lead or has formed ball on top of slug.

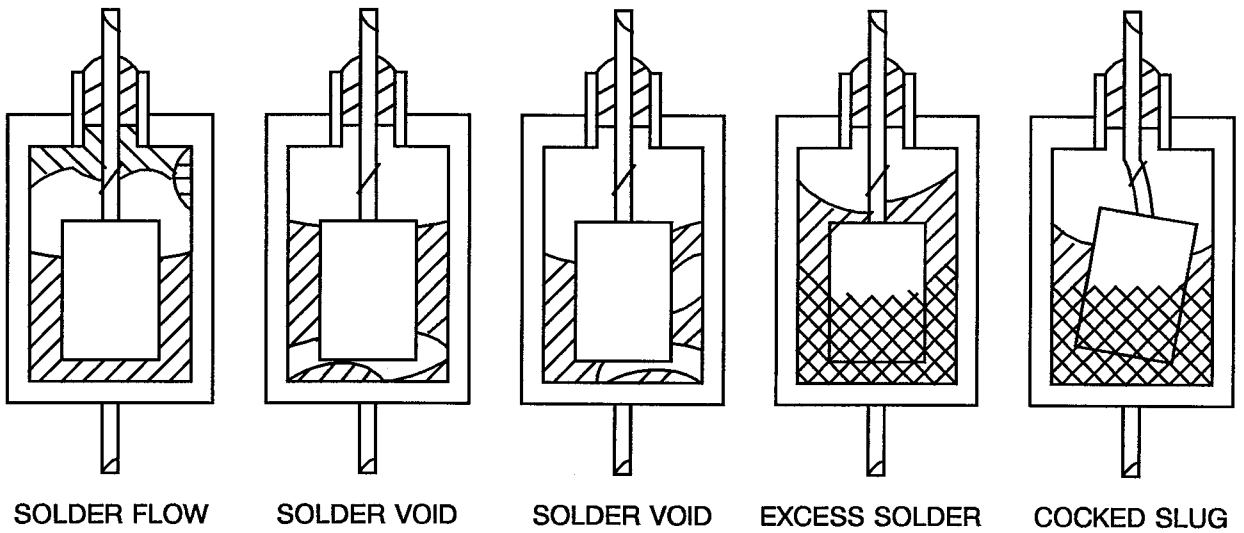


**FIGURE IV - ACCEPTABLE AND UNACCEPTABLE ITEMS FOR TANTALUM SOLID CAPACITORS**

ACCEPTABLE ITEMS



ACCEPTABLE ITEMS - MINOR DEFECTS



Normal solder fillet plus flow down case wall.

Slug coverage with solder at least 60%. Void at bottom of slug only if sides are well covered.

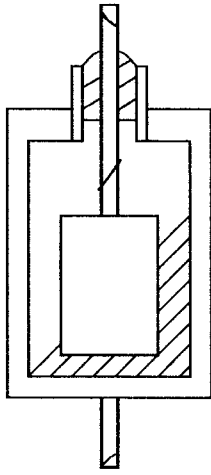
Slug coverage with solder at least 60%. Void at bottom of slug only if sides are well covered.

Top of slug and anode lead clearly visible.

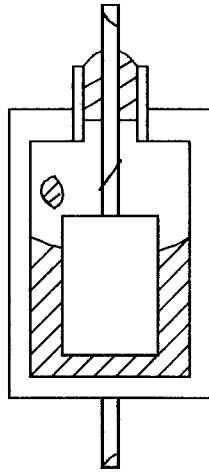
Slight curve of lead, and slug not touching case.



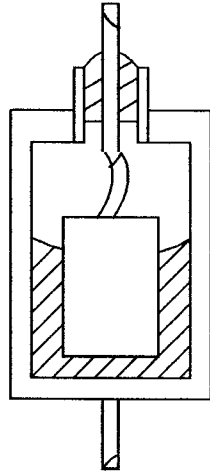
UNACCEPTABLE ITEMS



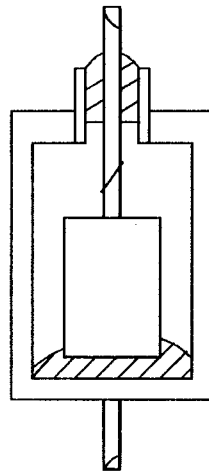
(a)



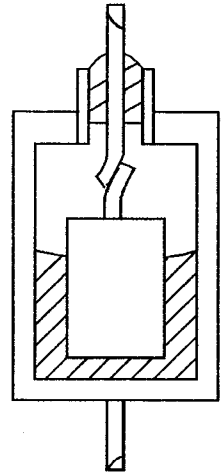
(b)



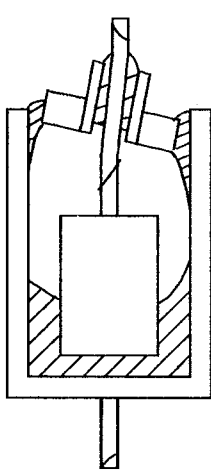
(c)



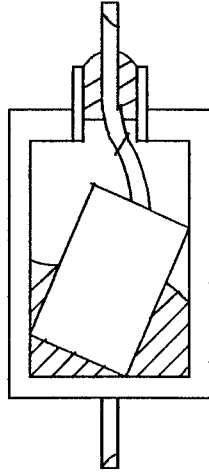
(d)



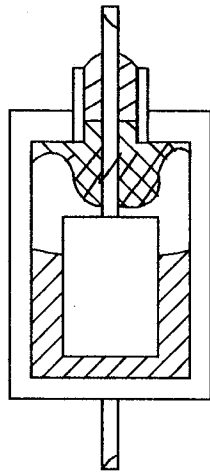
(e)



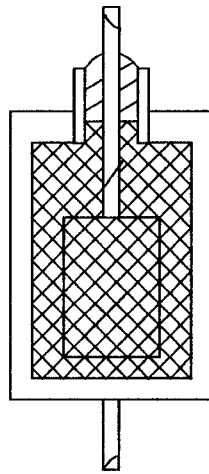
(f)



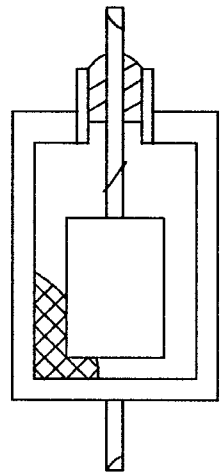
(g)



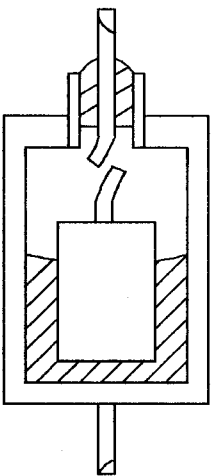
(h)



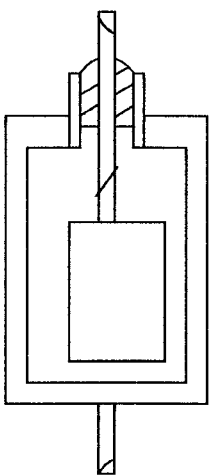
(i)



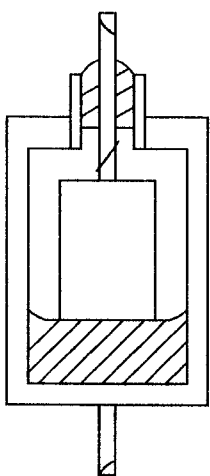
(j)



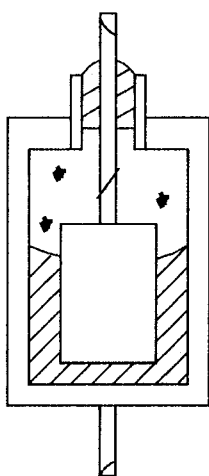
(k)



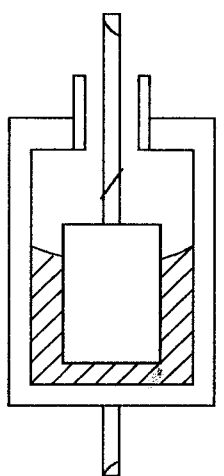
(l)



(m)



(n)



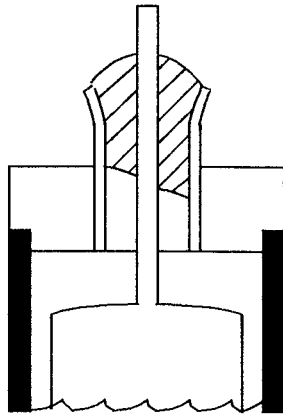
(o)

**NOTES**

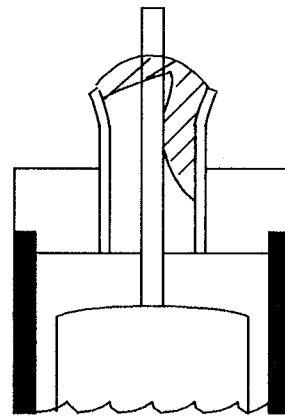
1. References (a) to (o) inclusive relate to Para. 4.3.1.



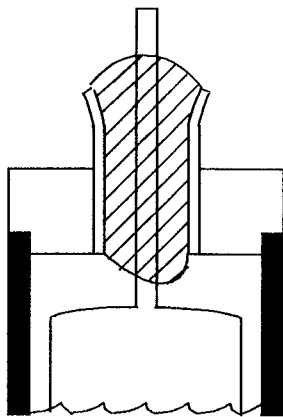
TUBELET DEFECTS



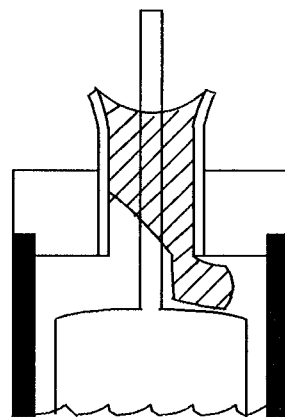
(p)



(q)



(r)



(s)

**NOTES**

1. References (p) to (s) inclusive relate to Para. 4.3.1.



4.3.2 Tantalum Non-solid Capacitors

(a) **Loose Particles**

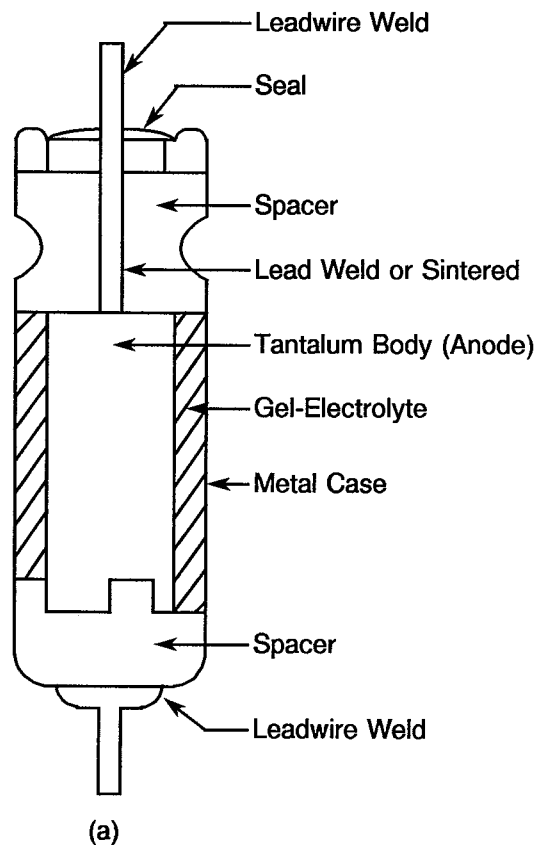
There shall be no loose metallic particles within the case that have a dimension equal to, or greater than, half the narrowest spacing of the anode-to-case (see Figure V (b)).

(b) **Physical Damage**

There shall be no evidence of a chipped or cracked anode or other physical damage to the tantalum body (see Figure V (e)).

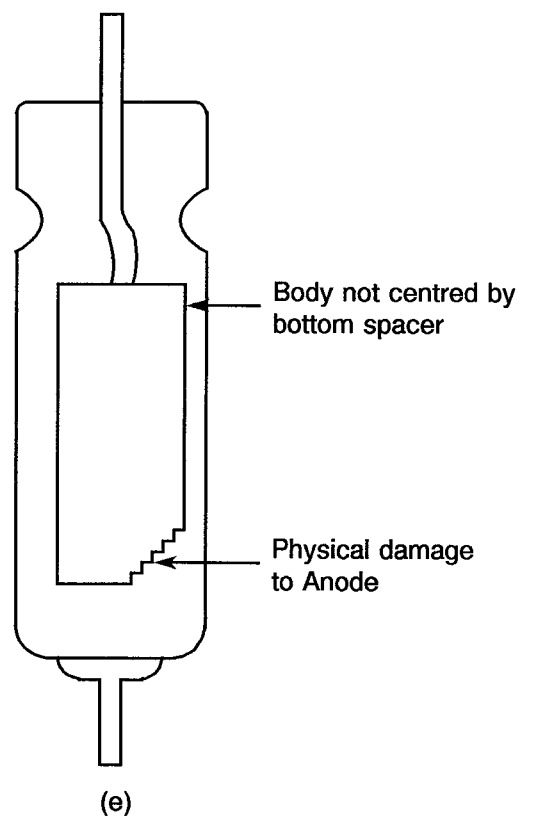
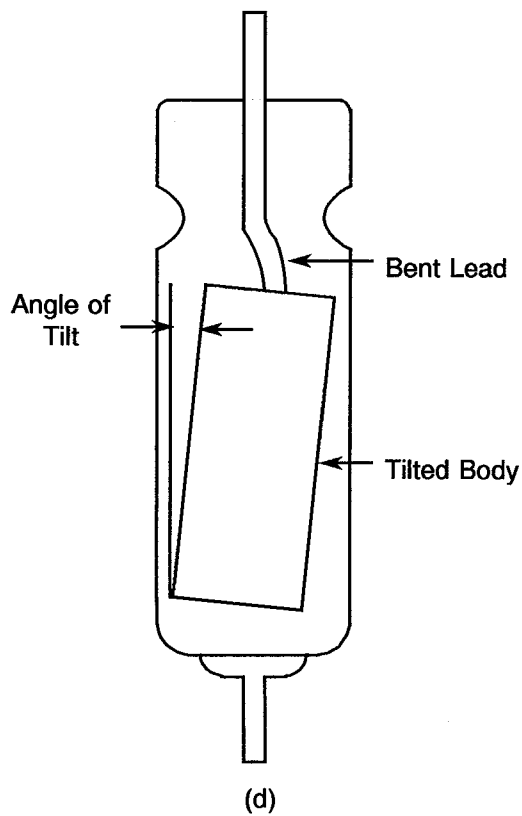
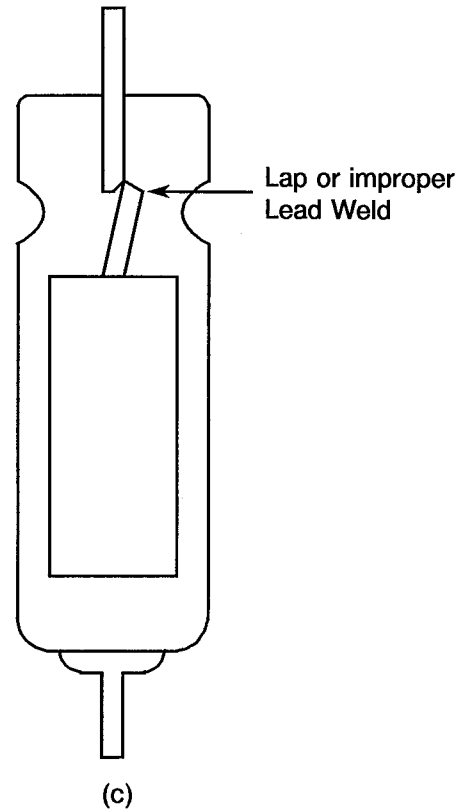
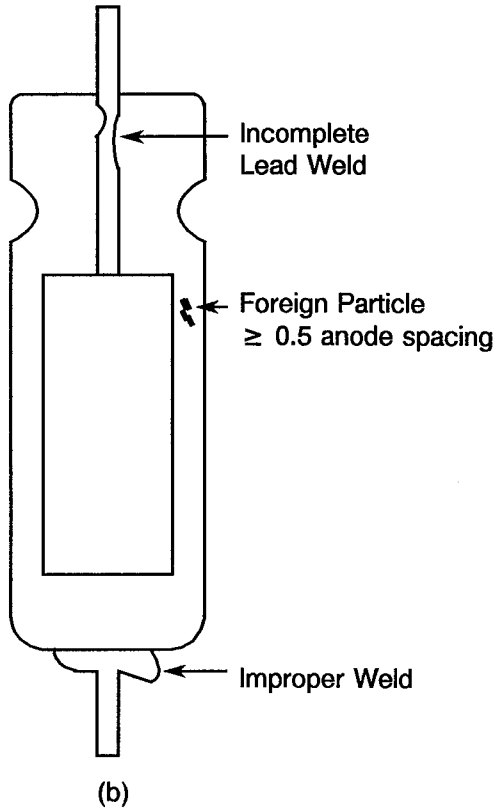
**FIGURE V - ACCEPTABLE AND UNACCEPTABLE ITEMS FOR TANTALUM NON-SOLID CAPACITORS**

ACCEPTABLE ITEM





UNACCEPTABLE ITEMS



**4.3.3 Hermetically Sealed, Tantalum Foil Capacitors****(a) Telescoping of Foil**

Although the allowable amount of telescoping will vary with the Manufacturer and case size, noticeable telescoping uncommon to the lot average shall be cause to reject the capacitor (see Figure VI(b)).

**(b) Foreign Particles**

Metallic foreign particles shall be cause for rejection if any one is greater than 0.125mm in its largest dimension.

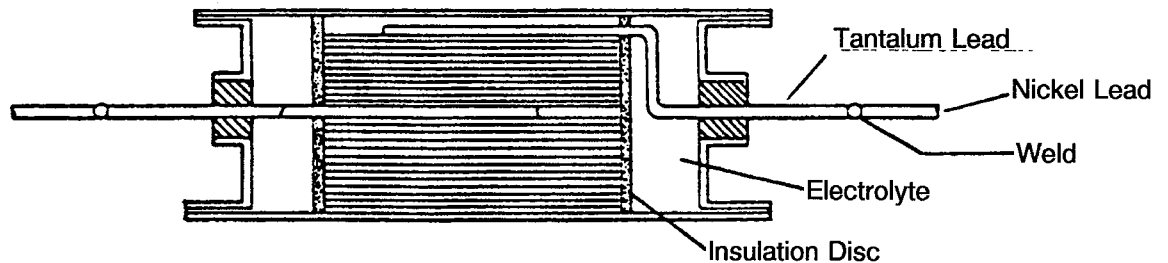
**(c) Lead Defects**

The portion of the lead which is perpendicular to the axis of the capacitor roll less than 0.794mm from the closest edge of the foil, whether the foil is telescoped or not (see Figure VI(d)).

**FIGURE VI - ACCEPTABLE AND UNACCEPTABLE ITEMS FOR HERMETICALLY SEALED TANTALUM FOIL CAPACITORS**

ACCEPTABLE ITEM

(a)

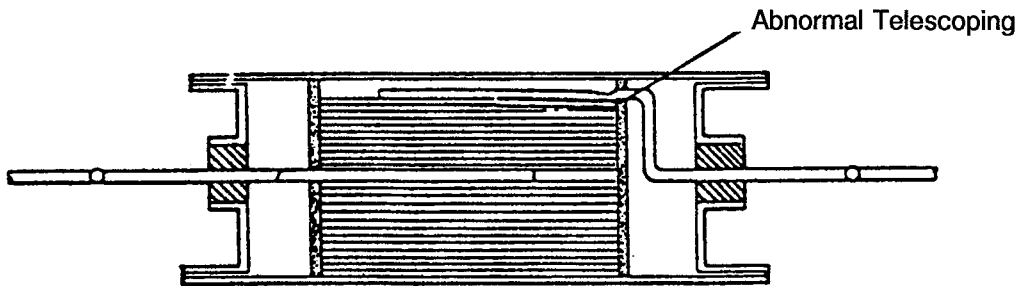




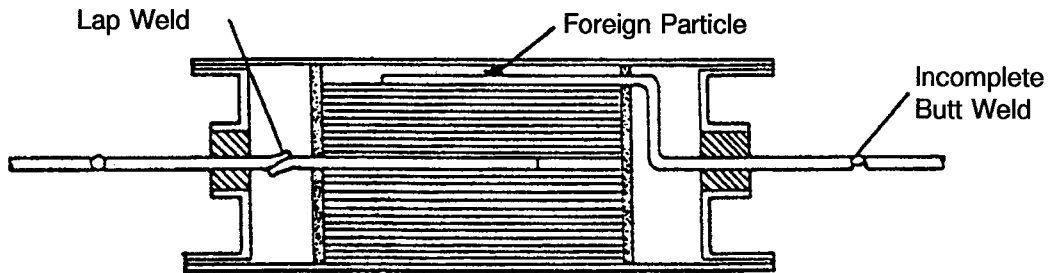


UNACCEPTABLE ITEMS

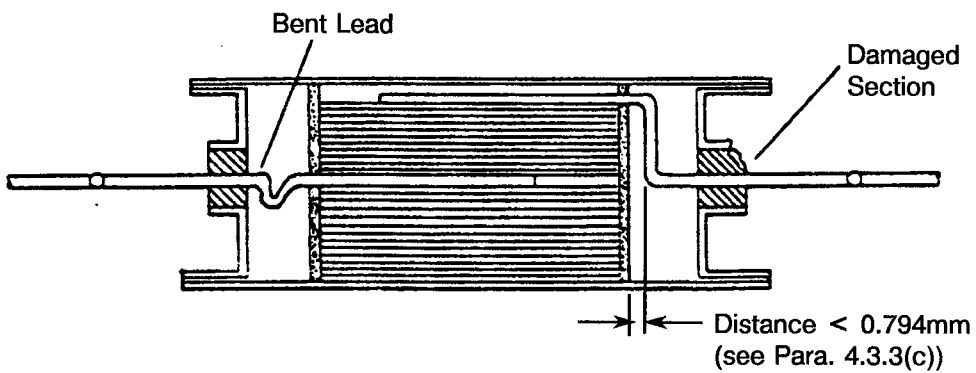
(b)



(c)



(d)

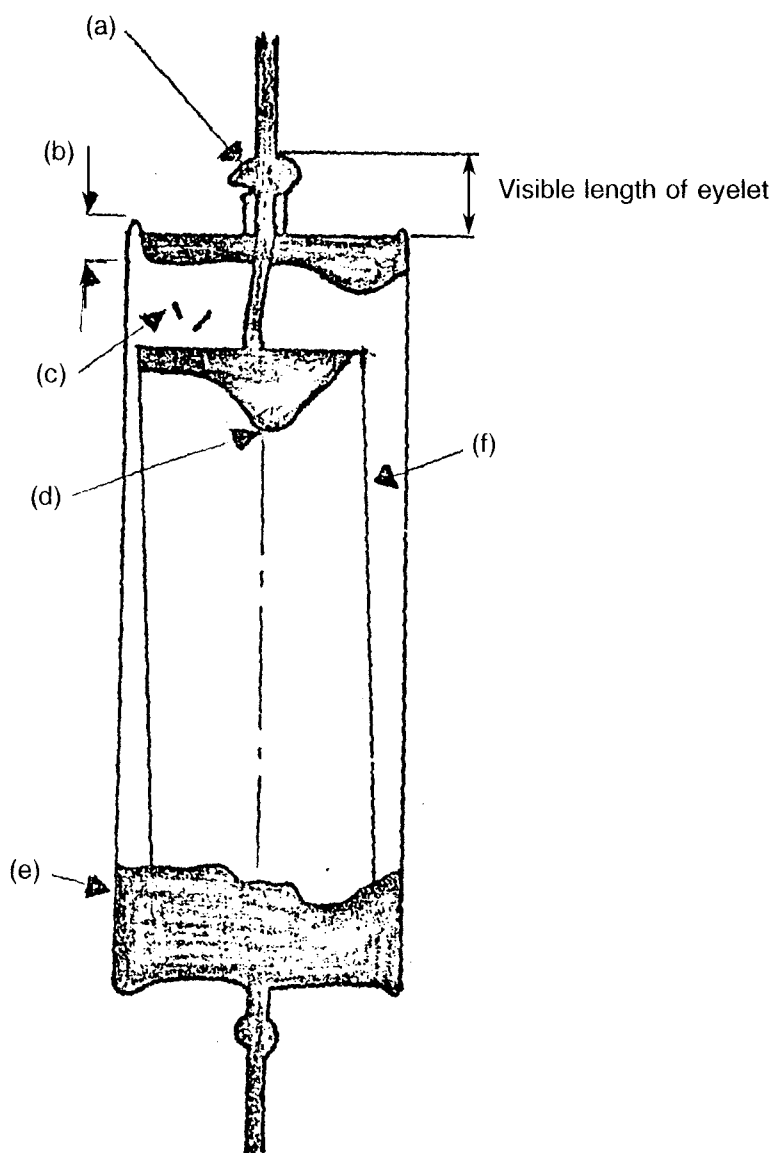




4.4 PLASTIC CAPACITORS

- (a) Visible length of eyelet less than 50% filled with solder.
- (b) Solder in heater/case joint less than 50% of length of joint.
- (c) Loose particles larger than 0.2mm in any dimension.
- (d) Solder spike longer than 0.5mm long.
- (e) Excessively long solder fillet extending beyond edge of winding.
- (f) Apparent asymmetry (i.e., not symmetrical).

**FIGURE VII - UNACCEPTABLE ITEMS FOR PLASTIC CAPACITORS**



**NOTES**

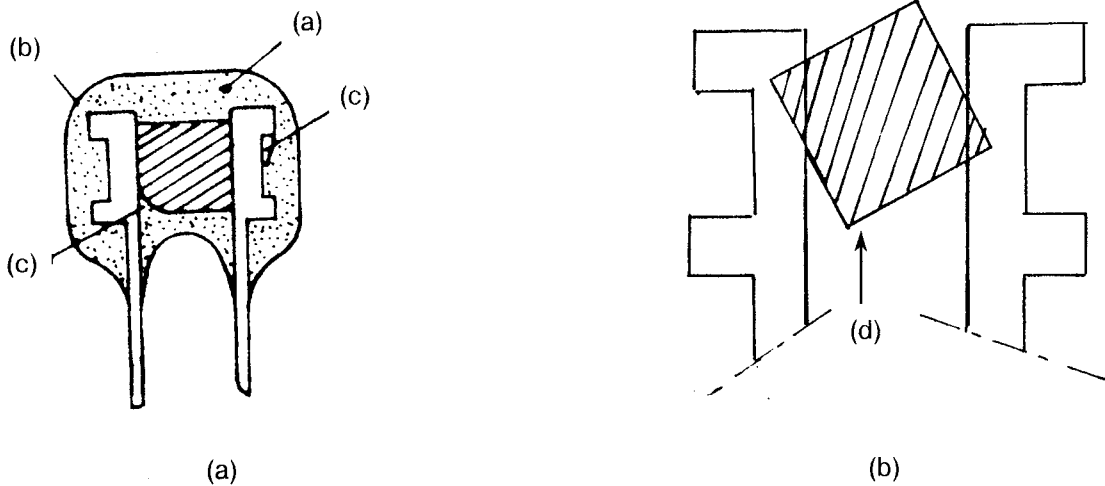
1. References (a) to (f) inclusive relate to Para. 4.4.



4.5 MICA CAPACITORS

- (a) Encapsulated foreign material (see Figure VIII(a)).
- (b) Thickness of coating or moulding not meeting the requirements of the approved Process Identification Documentation (see Figure VIII(a)).
- (c) Cracks, chip-outs or holes (see Figure VIII(a)).
- (d) Capacitor element offset with regard to end clamp (see Figure VIII(b)).

**FIGURE VIII - UNACCEPTABLE ITEMS FOR MICA CAPACITORS**



**NOTES**

- 1. References (a) to (d) inclusive relate to Para. 4.5.

4.6 FILTER CAPACITOR

- (a) Holes, cracks or chip-outs on the different elements.
- (b) Foreign material.
- (c) Positioning of the elements not in accordance with the approved production specification.