



europaean space agency
agence spatiale européenne

Pages 1 to 17

DIODES, MICROWAVE, SILICON,

PIN, SWITCHING,

BASED ON TYPE 1N5719

ESA/SCC Detail Specification No. 5513/028

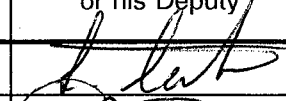
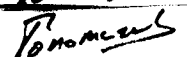
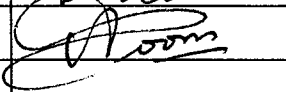

space components
coordination group

Issue/Rev.	Date	Approved by	
		SCCG Chairman	ESA Director General or his Deputy
Issue 1	September 1993		
Revision 'A'	November 1995		

**SCC**ESA/SCC Detail Specification
No. 5513/028

Rev. 'A'

PAGE 2

ISSUE 1

DOCUMENTATION CHANGE NOTICE

Rev. Letter	Rev. Date	Reference	CHANGE Item	Approved DCR No.
'A'	Nov. '95	P1. Cover page P2. DCN P3. T of C P5. Para. 1.7	: New Para 1.7 entry added : Existing entry Para. 1.7 renumbered to "1.8" : New Para. 1.7 entry added : Existing entry Para. 1.7 renumbered to "1.8"	None None 21083 21083 21083 21083



TABLE OF CONTENTS

	<u>Page</u>
1. <u>GENERAL</u>	5
1.1 Scope	5
1.2 Type Variants	5
1.3 Maximum Ratings	5
1.4 Parameter Derating Information	5
1.5 Physical Dimensions	5
1.6 Functional Diagram	5
1.7 High Temperature Test Precautions	5
1.8 Handling Precautions	5
2. <u>APPLICABLE DOCUMENTS</u>	5
3. <u>TERMS, DEFINITIONS, ABBREVIATIONS, SYMBOLS AND UNITS</u>	5
4. <u>REQUIREMENTS</u>	8
4.1 General	8
4.2 Deviations from Generic Specification	8
4.2.1 Deviations from Special In-process Controls	8
4.2.2 Deviations from Final Production Tests	8
4.2.3 Deviations from Burn-in and Electrical Measurements	8
4.2.4 Deviations from Qualification Tests	8
4.2.5 Deviations from Lot Acceptance Tests	8
4.3 Mechanical and Environmental Requirements	8
4.3.1 Dimension Check	8
4.3.2 Weight	8
4.3.3 Terminal Strength	9
4.4 Materials and Finishes	9
4.4.1 Case	9
4.4.2 Lead Materials and Finish	9
4.5 Marking	9
4.5.1 General	9
4.5.2 Cathode Identification	9
4.5.3 The SCC Component Number	9
4.5.4 Traceability Information	10
4.6 Electrical Measurements	10
4.6.1 Electrical Measurements at Room Temperature	10
4.6.2 Electrical Measurements at High and Low Temperatures	10
4.6.3 Circuits for Electrical Measurements	10
4.7 Burn-in Tests	10
4.7.1 Parameter Drift Values	10
4.7.2 Conditions for High Temperature Reverse Bias Burn-in	10
4.7.3 Conditions for Power Burn-in	10
4.7.4 Electrical Circuit for High Temperature Reverse Bias Burn-in	10
4.7.5 Electrical Circuit for Power Burn-in	10
4.8 Environmental and Endurance Tests	15
4.8.1 Electrical Measurements on Completion of Environmental Tests	15
4.8.2 Electrical Measurements at Intermediate Points and on Completion of Endurance Tests	15
4.8.3 Conditions for Operating Life Tests	15
4.8.4 Electrical Circuits for Operating Life Tests	15
4.9 Total Dose Irradiation Testing	15
4.10 Special Testing	15

TABLES

Page

1(a)	Type Variants	6
1(b)	Maximum Ratings	6
2	Electrical Measurements at Room Temperature - D.C. Parameters	11
	Electrical Measurements at Room Temperature - A.C. Parameters	11
3	Electrical Measurements at High and Low Temperatures	12
4	Parameter Drift Values	12
5(a)	Conditions for High Temperature Reverse Bias Burn-in	14
5(b)	Conditions for Power Burn-in and Operating Life Tests	14
6	Electrical Measurements at Intermediate Points and on Completion of Endurance Testing	16

FIGURES

1	Parameter Derating Information	6
2	Physical Dimensions	7
3	Functional Diagram	7
4	Circuits for Electrical Measurements	13
5(a)	Electrical Circuit for High Temperature Reverse Bias Burn-in	14
5(b)	Electrical Circuit for Power Burn-in and Operating Life Tests	14

APPENDICES (Applicable to specific Manufacturers only)

'A'	Agreed deviations for Hewlett-Packard (USA)	17
-----	---	----

**1. GENERAL****1.1 SCOPE**

This specification details the ratings, physical and electrical characteristics, test and inspection data for a Diode, Microwave, Silicon, PIN, Switching, based on Type 1N5719. It shall be read in conjunction with ESA/SCC Generic Specification No. 5010, the requirements of which are supplemented herein.

1.2 TYPE VARIANTS

Variants of the basic diodes specified herein, which are also covered by this specification are given in Table 1(a).

1.3 MAXIMUM RATINGS

The maximum ratings, which shall not be exceeded at any time during use or storage, applicable to the diodes specified herein, are as scheduled in Table 1(b).

1.4 PARAMETER DERATING INFORMATION

The derating information applicable to the diodes specified herein is shown in Figure 1.

1.5 PHYSICAL DIMENSIONS

The physical dimensions of the diodes specified herein are shown in Figure 2.

1.6 FUNCTIONAL DIAGRAM

The functional diagram, showing lead identification, of the diodes specified herein, is shown in Figure 3.

1.7 HIGH TEMPERATURE TEST PRECAUTIONS

For tin-lead plated or solder-dipped lead finish, all tests to be performed at a temperature that exceeds +125°C shall be carried out in 100% inert atmosphere.

1.8 HANDLING PRECAUTIONS

These devices are susceptible to damage by electrostatic discharge. Therefore, suitable precautions shall be employed for protection during all phases of manufacture, testing, packaging, shipment and any handling.

These components are categorised as Class 1 with a Minimum Critical Path Failure Voltage of 1000V.

2. APPLICABLE DOCUMENTS

The following documents form part of this specification and shall be read in conjunction with it:

(a) ESA/SCC Generic Specification No. 5010 for Discrete Microwave Semiconductor Components.

3. TERMS, DEFINITIONS, ABBREVIATIONS, SYMBOLS AND UNITS

For the purpose of this specification, the terms, definitions, abbreviations, symbols and units specified in ESA/SCC Basic Specification No. 21300 shall apply.

TABLE 1(a) - TYPE VARIANTS

(1) VARIANT	(2) BASED ON TYPE	(3) FIGURE	(4) TOTAL CAPACITANCE C_T (pF)		(5) LEAD MATERIAL AND FINISH
			MIN	MAX	
01	1N5719	2	-	0.3	D3 or D4
02	1N5719	2	-	0.3	D2

TABLE 1(b) - MAXIMUM RATINGS

No.	CHARACTERISTIC	SYMBOL	MAXIMUM RATINGS	UNIT	REMARKS
1	D.C. Reverse Voltage	V_R	- 100	V	Peak
2	D.C. Forward Current (Continuous)	I_F	100	mA	
3	R.F. Power Dissipation	P_{tot}	250	mW	Note 1
4	Operating Temperature Range	T_{op}	- 65 to + 150	°C	T_{case}
5	Storage Temperature Range	T_{stg}	- 65 to + 150	°C	
6	Soldering Temperature	T_{sol}	+ 230	°C	Note 2

NOTES

1. At $T_{case} = +25^\circ\text{C}$. For derating at $T_{case} > +25^\circ\text{C}$, see Figure 1.
2. Duration 5 seconds maximum at a distance of not less than 1.5mm from the body and the same termination shall not be resoldered until 3 minutes have elapsed.

FIGURE 1 - PARAMETER DERATING INFORMATION

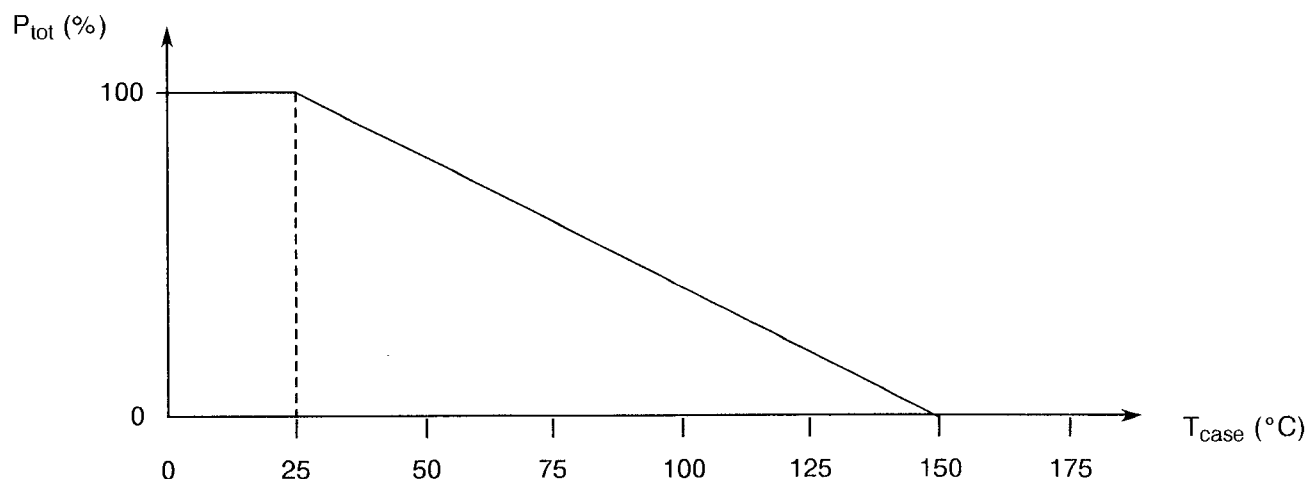

Power Dissipation versus Temperature

FIGURE 2 - PHYSICAL DIMENSIONS

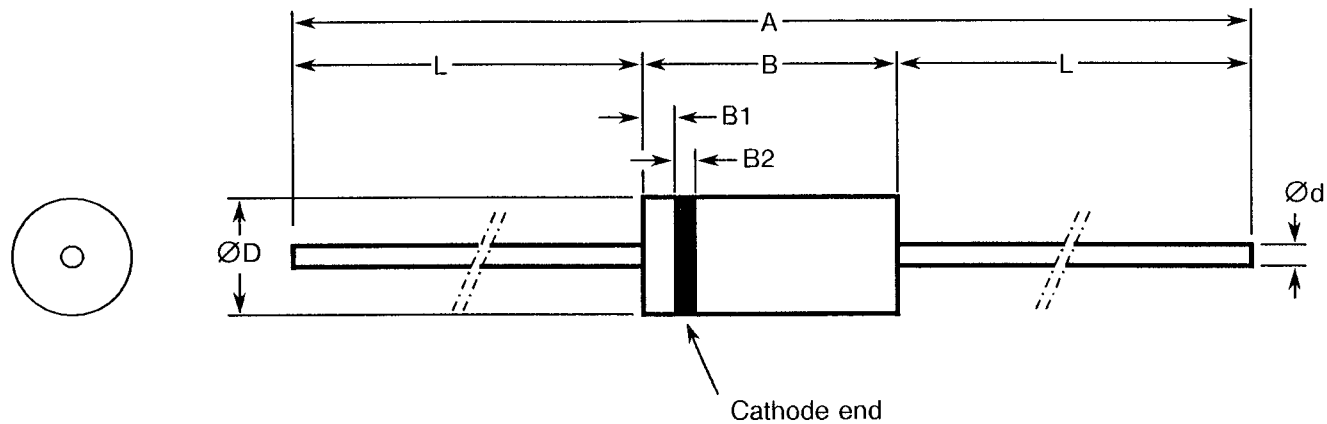

SYMBOL	MILLIMETRES	
	MIN	MAX
A	54.48	80.39
B	3.68	4.19
B1	0.10	1.04
B2	0.30	0.80
Ød	0.35	0.41
ØD	1.73	1.91
L	25.40	38.10

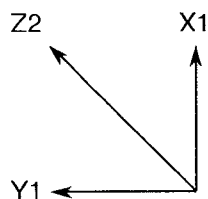
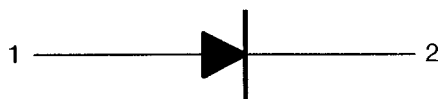



FIGURE 3 - FUNCTIONAL DIAGRAM



- 1. Anode
- 2. Cathode

NOTES

- 1. The cathode end shall be marked with a contrasting coloured band.

 	ESA/SCC Detail Specification No. 5513/028		PAGE 8 ISSUE 1
--	--	--	-------------------

4. REQUIREMENTS

4.1 GENERAL

The complete requirements for procurement of the diodes specified herein shall be as stated in this specification and ESA/SCC Generic Specification No. 5010 for Discrete Microwave Semiconductor Components. Deviations from the Generic Specification applicable to this specification only, are listed in Para. 4.2.

Deviations from the applicable Generic Specification and this Detail Specification, formally agreed with specific Manufacturers on the basis that the alternative requirements are equivalent to the ESA/SCC requirements and do not affect the components' reliability, are listed in the appendices attached to this specification.

4.2 DEVIATIONS FROM GENERIC SPECIFICATION

4.2.1 Deviations from Special In-process Controls

(a) Para. 5.3, Wafer Lot Acceptance: Shall be performed as an S.E.M. Inspection only.

4.2.2 Deviations from Final Production Tests (Chart II)

(a) Para. 9.2.1, Bond Strength: Shall not be performed.

(b) Para. 9.2.2, Die Shear: Shall not be performed and no additional thermal tests shall be performed to replace this test.

4.2.3 Deviations from Burn-in and Electrical Measurements (Chart III)

None.

4.2.4 Deviations from Qualification Tests (Chart IV)

(a) Para. 9.2.3, Bond Strength: Shall not be performed.

(b) Para. 9.2.4, Die Shear: Shall not be performed. Thermal resistance measurements shall be performed in accordance with Table 2 of this specification.

(c) Para. 9.20, Operating Life: Only one Operating Life Test shall be performed on 30 components.

(d) Para. 9.23, Special Testing: Shall not be performed.

4.2.5 Deviations from Lot Acceptance Tests (Chart V)

(a) Para. 9.20, Operating Life: Only one Operating Life Test shall be performed on 16 components.

(b) Para. 9.23, Special Testing: Shall not be performed.

4.3 MECHANICAL AND ENVIRONMENTAL REQUIREMENTS

4.3.1 Dimension Check

The dimensions of the diodes specified herein shall be checked. They shall conform to those shown in Figure 2.

4.3.2 Weight

The maximum weight of the diodes specified herein shall be 0.10 grammes.



4.3.3 Terminal Strength

The requirements for terminal strength testing are specified in Section 9 of ESA/SCC Generic Specification No. 5010. The test conditions shall be as follows:-

- (a) Condition: 'A' (Tension).
- (b) Force: 5.0N.
- (c) Duration: 10 seconds.

4.4 MATERIALS AND FINISHES

The materials and finishes shall be as specified herein. Where a definite material is not specified, a material which will enable the diodes specified herein to meet the performance requirements of this specification shall be used. Acceptance or approval of any constituent material shall not guarantee acceptance of the finished product.

4.4.1 Case

The case shall be hermetically sealed and have a glass body.

4.4.2 Lead Materials and Finish

The material shall be Type 'D' with either Type '2' or Type '3 or 4' finish in accordance with the requirements of ESA/SCC Basic Specification No. 23500.

4.5 MARKING

4.5.1 General

The marking of components delivered to this specification shall be in accordance with the requirements of ESA/SCC Basic Specification No. 21700 and the following paragraphs. When the component is too small to accommodate all of the marking specified, as much as space permits shall be marked and the marking information, in full, shall accompany the component in its primary package.

The information to be marked and the order of precedence, shall be as follows:-

- (a) Cathode Identification.
- (b) The SCC Component Number.
- (c) Traceability Information.



4.5.2 Cathode Identification

Cathode identification shall be as shown in Figures 2 and 3 of this specification.

4.5.3 The SCC Component Number

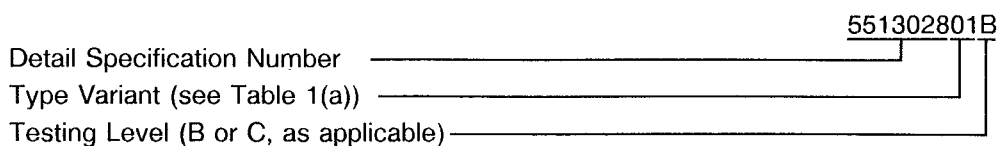
Each component shall bear the SCC Component Number which shall be constituted and marked as follows:



 	ESA/SCC Detail Specification No. 5513/028		PAGE 10 ISSUE 1
---	--	--	--------------------

4.5.4 Traceability Information

Each component shall be marked in respect of traceability information as defined in ESA/SCC Basic Specification No. 21700.

4.6 ELECTRICAL MEASUREMENTS

4.6.1 Electrical Measurements at Room Temperature

The parameters to be measured at room temperature are scheduled in Table 2. Unless otherwise specified, the measurements shall be performed at $T_{amb} = +25 \pm 3$ °C.

4.6.2 Electrical Measurements at High and Low Temperatures

The parameters to be measured at high and low temperatures are scheduled in Table 3. Unless otherwise specified, the measurements shall be performed at $+150(+0 - 5)$ °C.

4.6.3 Circuits for Electrical Measurements

Circuits for use in performing electrical measurements listed in Table 2 of this specification are shown in Figure 4.

4.7 BURN-IN TESTS

Burn-in shall be Category 3 of Chart III(a).

4.7.1 Parameter Drift Values

The parameter drift values applicable to burn-in are specified in Table 4 of this specification. Unless otherwise stated, the measurements shall be performed at $T_{amb} = +25 \pm 3$ °C. The parameter drift values (Δ) applicable to the scheduled parameters shall not be exceeded. In addition to these drift value requirements for a given parameter, the appropriate limit value specified in Table 2 shall not be exceeded.

4.7.2 Conditions for High Temperature Reverse Bias Burn-in

The requirements for the high temperature reverse bias burn-in are specified in Section 7 of ESA/SCC Generic Specification No. 5010. The conditions for high temperature reverse bias burn-in shall be as specified in Table 5(a) of this specification.

4.7.3 Conditions for Power Burn-in

The requirements for power burn-in are specified in Section 7 of ESA/SCC Generic Specification No. 5010. The conditions for power burn-in shall be as specified in Table 5(b) of this specification.

4.7.4 Electrical Circuit for High Temperature Burn-in

Circuit for use in performing the H.T.R.B burn-in tests is shown in Figure 5(a) of this specification.

4.7.5 Electrical Circuit for Power Burn-in

Circuit for use in performing the power burn-in tests is shown in Figure 5(b) of this specification.

**TABLE 2 - ELECTRICAL MEASUREMENTS AT ROOM TEMPERATURE - D.C. PARAMETERS**

No.	CHARACTERISTICS	SYMBOL	MIL-STD-750 TEST METHOD	TEST CONDITIONS	LIMITS		UNIT
					MIN.	MAX.	
1	Reverse Current	I_R	4016	$V_R = -100V$	-	250	nA
2	Forward Voltage	V_F	4011	$I_F = 100mA$	-	1.0	V
3	Thermal Resistance	$R_{TH(J-C)}$	3101	$I_F = 1.0A$ Note 1	-	500	°C/W

NOTES

1. Pulsed measurement, pulse width = 4.0 μ s, p.r.f. = 1.0kHz.

TABLE 2 - ELECTRICAL MEASUREMENTS AT ROOM TEMPERATURE - A.C. PARAMETERS

No.	CHARACTERISTICS	SYMBOL	MIL-STD-750 TEST METHOD	TEST FIG.	TEST CONDITIONS	LIMITS		UNIT
						MIN.	MAX.	
4	Total Capacitance	C_T	4001	-	$V_R = -100V$ $f = 1.0MHz$	-	0.3	pF
5	Minority Carrier Lifetime	τ_L	-	4(a)	$I_R = 250mA$ $I_F = 50mA$ Note 1	100	-	ns
6	Forward Slope Resistance	R_{FS}	-	4(b)	$I_F = 100mA$ $f_o = 100MHz$	-	1.25	Ω

NOTES

1. The lifetime τ_L is measured across the 50% points of the observed waveform.

**TABLE 3 - ELECTRICAL MEASUREMENTS AT HIGH AND LOW TEMPERATURES**

No.	CHARACTERISTICS	SYMBOL	SPEC.AND/OR TEST METHOD	TEST CONDITIONS	LIMITS		UNIT
					MIN.	MAX.	
1	Reverse Current	I_R	As per Table 2	As per Table 2	-	15	μA

TABLE 4 - PARAMETER DRIFT VALUES

No.	CHARACTERISTICS	SYMBOL	SPEC.AND/OR TEST METHOD	TEST CONDITIONS	CHANGE LIMITS (Δ)	UNIT
1	Reverse Current	I_R	As per Table 2	As per Table 2	± 50 (1) or (2) ± 100 (1)	nA %
2	Forward Voltage	V_F	As per Table 2	As per Table 2	± 10 (1)	%
4	Total Capacitance	C_T	As per Table 2	As per Table 2	± 10	%

NOTES1. $\Delta 1 = \Delta 2 = \Delta 3$

2. Whichever is the greater, referred to the initial measurement.



FIGURE 4 - CIRCUITS FOR ELECTRICAL MEASUREMENTS

FIGURE 4(a) - FORWARD SLOPE RESISTANCE

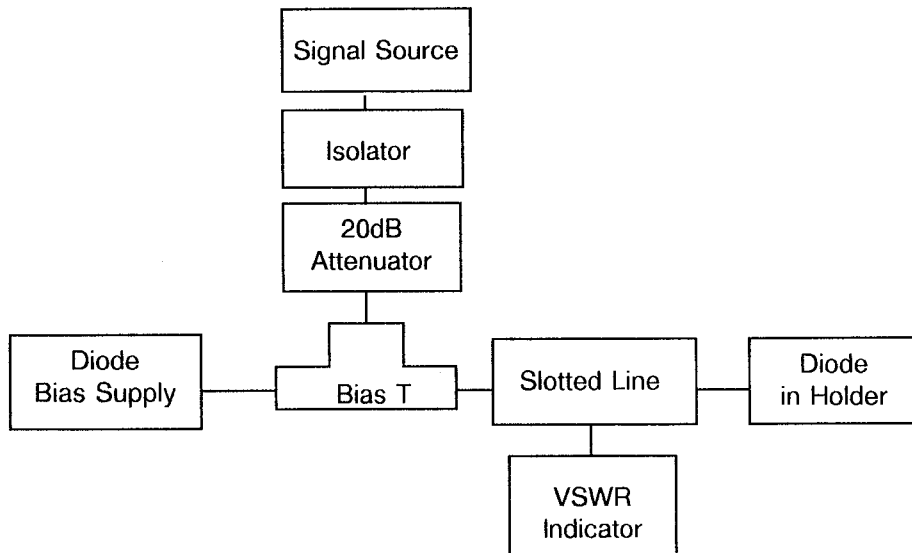

Method:

Place DUT in a suitable holder which terminates a 50Ω transmission line. Apply a D.C. bias to the diode and an input signal at a maximum level of 1.0mW to the transmission line. Measure the VSWR of the line which the diode terminates. Calculate R_{FS} of the diode from the following formula:

$$R_{FS} = (50/VSWR) - R_{HSC}, \text{ where } R_{HSC} = \text{diode holder short circuit resistance.}$$

R_{HSC} can be determined by measuring the VSWR of the diode holder with a short circuit in the holder. The short circuit can be made of metal in the shape of the diode.

FIGURE 4(b) - MINORITY CARRIER LIFETIME

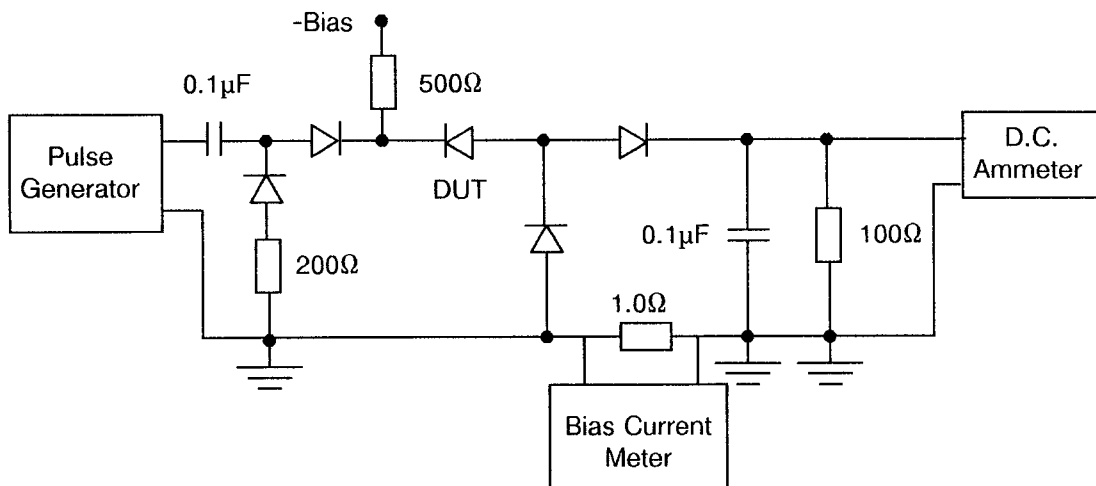

Method:

A pulse from a 10kHz ±200Hz pulse generator and forward bias from a power supply shall be applied to the diode under test. Reverse current shall be ≥250mA_{dc} and forward bias shall be 50mA_{dc}. Read current on D.C. ammeter and divide this current by the product of pulse repetition frequency and bias current to obtain carrier lifetime.

NOTES

1. Diodes shall be 1N5712 hot carrier diodes or equivalent.



TABLE 5(a) - CONDITIONS FOR HIGH TEMPERATURE REVERSE BIAS BURN-IN

No.	CHARACTERISTICS	SYMBOL	CONDITIONS	UNIT
1	Ambient Temperature	T_{amb}	+ 150(+ 0 - 5)	°C
2	Reverse Voltage	V_R	- 80	V
3	Duration	t	72	Hours

TABLE 5(b) - CONDITIONS FOR POWER BURN-IN AND OPERATING LIFE TESTS

No.	CHARACTERISTICS	SYMBOL	CONDITIONS	UNIT
1	Ambient Temperature	T_{amb}	+ 25(+ 0 - 5)	°C
2	Reverse Voltage	V_R	-120	Vac(pk)
3	Frequency	f	60	Hz

FIGURE 5(a) - ELECTRICAL CIRCUIT FOR HIGH TEMPERATURE REVERSE BIAS BURN-IN

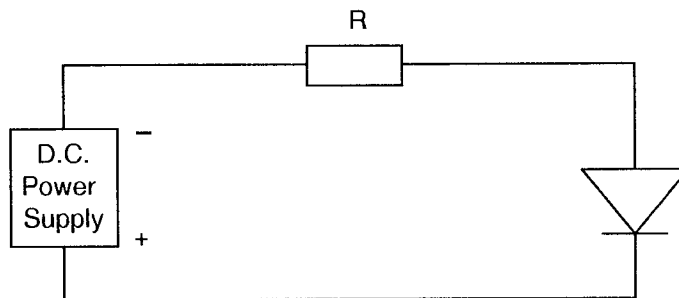
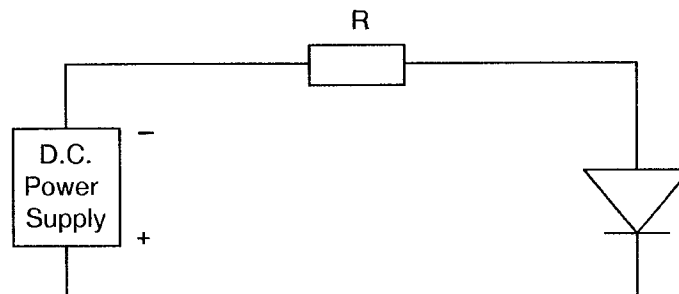



FIGURE 5(b) - ELECTRICAL CIRCUIT FOR POWER BURN-IN AND OPERATING LIFE TESTS



	<p style="text-align: center;">ESA/SCC Detail Specification No. 5513/028</p>	<p style="text-align: right;">PAGE 15 ISSUE 1</p>
---	--	---

4.8 ENVIRONMENTAL AND ENDURANCE TESTS (CHARTS IV AND V OF ESA/SCC GENERIC SPECIFICATION NO. 5010)

4.8.1 Electrical Measurements on Completion of Environmental Tests

The parameters to be measured on completion of environmental tests are scheduled in Table 2. Unless otherwise stated, the measurements shall be performed at $T_{amb} = +25 \pm 3$ °C.

4.8.2 Electrical Measurements at Intermediate Points and on Completion of Endurance Tests

The parameters to be measured at intermediate points and on completion of endurance tests are scheduled in Table 6. Unless otherwise stated, the measurements shall be performed at $T_{amb} = +25 \pm 3$ °C.

4.8.3 Conditions for Operating Life Tests (Part of Endurance Testing)

The requirements for operating life testing are specified in Section 9 of ESA/SCC Generic Specification No. 5010. The conditions for operating life testing are specified in Table 5(b) of this specification.

4.8.4 Electrical Circuits for Operating Life Tests

The circuit to be used for performance of the operating life test shall be the same as shown in Figure 5(b) for Power Burn-in.

4.9 TOTAL DOSE IRRADIATION TESTING

Not applicable.

4.10 SPECIAL TESTING

Not applicable.

**TABLE 6 - ELECTRICAL MEASUREMENTS AT INTERMEDIATE POINTS AND ON COMPLETION OF ENDURANCE TESTING**

No.	CHARACTERISTICS	SYMBOL	SPEC. AND/OR TEST METHOD	TEST CONDITIONS	CHANGE LIMITS (Δ)	LIMITS		UNIT
						MIN.	MAX.	
1	Reverse Current	I_R	As per Table 2	As per Table 2	± 0.25 or (2) ± 100	-	1.0	μA %
2	Forward Voltage	V_F	As per Table 2	As per Table 2	$\pm 10\%$	As per Table 2		V
4	Total Capacitance	C_T	As per Table 2	As per Table 2	$\pm 10\%$	As per Table 2		pF
5	Minority Carrier Lifetime	τ_L	As per Table 2	As per Table 2	-	As per Table 2		ns

NOTES

1. The lifetime τ_L is measured across the 50% points of the observed waveform. τ_L
2. Whichever is the greater, referred to the initial measurement.

	<p style="text-align: center;">ESA/SCC Detail Specification No. 5513/028</p>		<p>PAGE 17 ISSUE 1</p>
---	--	--	----------------------------

APPENDIX 'A'

Page 1 of 1

AGREED DEVIATIONS FOR HEWLETT-PACKARD (USA)

ITEMS AFFECTED	DESCRIPTION OF DEVIATIONS
Para. 4.2.1	<p>Para. 5.3, Wafer Lot Acceptance: Prior to the start of processing, 3 randomly chosen encapsulated samples shall be submitted to the User for wafer approval. These samples shall be fully tested to Table 2 and shall then be shipped to the Orderer. When the User has tested the samples and granted his approval, the Orderer shall inform the Manufacturer who will then continue processing the wafer to ESA/SCC requirements.</p>