



europaean space agency
agence spatiale européenne

Pages 1 to 24

**TRANSISTORS, MICROWAVE,
SMALL SIGNAL, SILICON, BIPOLAR
BASED ON TYPES BFY180 THRU BFY183,
BFY193 AND BFY280
ESA/SCC Detail Specification No. 5611/006**



**space components
coordination group**

Issue/Rev.	Date	Approved by	
		SCCG Chairman	ESA Director General or his Deputy
Issue 1	May 1995	<i>P. H. M. C. S.</i>	<i>[Signature]</i>



SCC

ESA/SCC Detail Specification
No. 5611/006

PAGE 2
ISSUE 1

DOCUMENTATION CHANGE NOTICE

Rev. Letter	Rev. Date	Reference	CHANGE Item	Approved DCR No.



	<p style="text-align: center;">ESA/SCC Detail Specification No. 5611/006</p>		<p>PAGE 3 ISSUE 1</p>
---	--	--	---------------------------

TABLE OF CONTENTS

		<u>Page</u>
1.	<u>GENERAL</u>	5
1.1	Scope	5
1.2	Component Type Variants	5
1.3	Maximum Ratings	5
1.4	Parameter Derating Information	5
1.5	Physical Dimensions	5
1.6	Functional Diagram	5
1.7	Handling Precautions	5
2.	<u>APPLICABLE DOCUMENTS</u>	5
3.	<u>TERMS, DEFINITIONS, ABBREVIATIONS, SYMBOLS AND UNITS</u>	5
4.	<u>REQUIREMENTS</u>	10
4.1	General	10
4.2	Deviations from Generic Specification	10
4.2.1	Deviations from Special In-process Controls	10
4.2.2	Deviations from Final Production Tests	10
4.2.3	Deviations from Burn-in and Electrical Measurements	10
4.2.4	Deviations from Qualification Tests	10
4.2.5	Deviations from Lot Acceptance Tests	10
4.3	Mechanical Requirements	11
4.3.1	Dimension Check	11
4.3.2	Weight	11
4.3.3	Terminal Strength	11
4.4	Materials and Finishes	11
4.4.1	Case	12
4.4.2	Lead Material and Finish	12
4.5	Marking	12
4.5.1	General	13
4.5.2	Collector Identification	12
4.5.3	The SCC Component Number	12
4.5.4	Traceability Information	12
4.6	Electrical Measurements	12
4.6.1	Electrical Measurements at Room Temperature	12
4.6.2	Electrical Measurements at High and Low Temperatures	12
4.6.3	Circuits for Electrical Measurements	13
4.7	Burn-in Tests	13
4.7.1	Parameter Drift Values	13
4.7.2	Conditions for High Temperature Reverse Bias Burn-in	13
4.7.3	Conditions for Power Burn-in	13
4.7.4	Electrical Circuits for High Temperature Reverse Bias Burn-in	13
4.7.5	Electrical Circuits for Power Burn-in	13
4.8	Environmental and Endurance Tests	22
4.8.1	Electrical Measurements on Completion of Environmental Tests	22
4.8.2	Electrical Measurements at Intermediate Points and on Completion of Endurance Tests	22
4.8.3	Conditions for Operating Life Tests	22
4.8.4	Electrical Circuits for Operating Life Tests	22
4.9	Total Dose Irradiation Testing	22
4.10	Special Testing	22

		<p>ESA/SCC Detail Specification No. 5611/006</p>	<p>PAGE 4 ISSUE 1</p>
---	---	--	---------------------------

TABLES

	<u>Page</u>
1(a) Type Variants	6
1(b) Maximum Ratings	7
2 Electrical Measurements at Room Temperature - d.c. Parameters	14
Electrical Measurements at Room Temperature - a.c. Parameters	15
3(a) Electrical Measurements at High Temperature	17
3(b) Electrical Measurements at Low Temperature	17
4 Parameter Drift Values	19
5(a) Conditions for High Temperature Reverse Bias Burn-in	20
5(b) Conditions for Power Burn-in and Operating Life Tests	20
6 Electrical Measurements at Intermediate Points and on Completion of Endurance Testing	23
7 Electrical Measurements During and on Completion of Irradiation Testing	23

FIGURES

1 Parameter Derating Information	8
2 Physical Dimensions	9
3 Functional Diagram	9
4 Circuits for Electrical Measurements	18
5(a) Electrical Circuit for High Temperature Reverse Bias Burn-in	21
5(b) Electrical Circuit for Power Burn-in and Operating Life Tests	21
6 Bias Conditions for Irradiation Testing	23

APPENDICES (Applicable to specific Manufacturers only)

'A' Agreed Deviations for Siemens (D)	24
---------------------------------------	----

	<p style="text-align: center;">ESA/SCC Detail Specification No. 5611/006</p>	<p style="text-align: right;">PAGE 5 ISSUE 1</p>
--	--	--

1. GENERAL

1.1 SCOPE

This specification details the ratings, physical and electrical characteristics, test and inspection data for a Transistor, Microwave, Small Signal, Silicon, Bipolar, based on Types BFY180 thru BFY183, BFY193 and BFY280. It shall be read in conjunction with ESA/SCC Generic Specification No. 5010, the requirements of which are supplemented herein.

1.2 COMPONENT TYPE VARIANTS

Variants of the basic type transistors specified herein, which are also covered by this specification, are given in Table 1(a).

1.3 MAXIMUM RATINGS

The maximum ratings, which shall not be exceeded at any time during use or storage, applicable to the transistor specified herein, are as scheduled in Table 1(b).

1.4 PARAMETER DERATING INFORMATION

The derating information applicable to the transistors specified herein is shown in Figure 1.

1.5 PHYSICAL DIMENSIONS

The physical dimensions of the transistors specified herein are shown in Figure 2.

1.6 FUNCTIONAL DIAGRAM

The functional diagram, showing lead identification of the transistors specified herein, is shown in Figure 3.

1.7 HANDLING PRECAUTIONS

These devices are susceptible to damage by electrostatic discharge. Therefore suitable precautions shall be employed for protection during all phases of manufacture test, packaging, shipping and handling.

These components are categorised as Class 1 with a Minimum Critical Path Failure Voltage of 500V for Variants 01 to 03 and 1 000V for Variants 04 to 06.

2. APPLICABLE DOCUMENTS

The following documents form part of this specification and shall be read in conjunction with it:

- (a) ESA/SCC Generic Specification No. 5010 for Discrete Microwave Semiconductor Components.
- (b) MIL-STD-750, Test Methods for Semiconductor Devices.

3. TERMS, DEFINITIONS, ABBREVIATIONS, SYMBOLS AND UNITS

For the purpose of this specification, the terms, definitions, abbreviations, symbols and units specified in ESA/SCC Basic Specification No. 21300 shall apply. In addition, the following abbreviations are used:-

- $R_{TH(J-S)}$ = Thermal Resistance, Junction-Soldering Point.
- MAG = Maximum Available Gain.
- MSG = Maximum Stable Gain.

**SCC**ESA/SCC Detail Specification
No. 5611/006

PAGE 6

ISSUE 1

TABLE 1(a) - TYPE VARIANTS

VARIANT	TYPE	CASE	FIGURE	END-CAP BODY-LID AND LEAD MATERIAL AND FINISH
01	BFY180	MICRO-X	2	D2
02	BFY280	MICRO-X	2	D2
03	BFY181	MICRO-X	2	D2
04	BFY182	MICRO-X	2	D2
05	BFY183	MICRO-X	2	D2
06	BFY193	MICRO-X	2	D2

**TABLE 1(b) - MAXIMUM RATINGS**

No.	CHARACTERISTICS	SYMBOL	MAXIMUM RATINGS (1)	UNIT	REMARKS
1	Collector-Emitter Voltage Variants 01-02 Variants 03-04-05-06	V_{CEO}	8.0 12	V	
2	Collector-Emitter Voltage $V_{BE} = 0V$ Variants 01-02 Variants 03-04-05-06	V_{CES}	15 20	V	
3	Collector-Base Voltage Variants 01-02 Variants 03-04-05-06	V_{CBO}	15 20	V	
4	Emitter-Base Voltage	V_{EBO}	2.0	V	
5	Collector Current Variant 01 Variant 02 Variant 03 Variant 04 Variant 05 Variant 06	I_C	4.0 10 20 35 65 80	mA	
6	Power Dissipation Variant 01 Variant 02 Variant 03 Variant 04 Variant 05 Variant 06	P_{tot}	30 ($T_S \leq 176$) 80 ($T_S \leq 164$) 175 ($T_S \leq 137$) 250 ($T_S \leq 136$) 450 ($T_S \leq 99$) 580 ($T_S \leq 104$)	mW ($^{\circ}C$)	Notes 2 and 3
7	Operating Temperature Range	T_{op}	- 65 to + 200	$^{\circ}C$	T_{amb}
8	Storage Temperature Range	T_{stg}	- 65 to + 200	$^{\circ}C$	
9	Soldering Temperature	T_{sol}	+ 250	$^{\circ}C$	Note 4
10	Junction Temperature	T_J	200	$^{\circ}C$	
11	Thermal Resistance, (Junction to Soldering Point) Variant 01 Variant 02 Variant 03 Variant 04 Variant 05 Variant 06	$R_{TH(J-S)}$	≤ 805 ≤ 450 ≤ 360 ≤ 255 ≤ 225 ≤ 165	$^{\circ}C/W$	Note 2

NOTES

- Maximum ratings must not be exceeded under any combination of d.c. ratings and R.F. voltage/current swings.
- T_S is measured on the collector lead at the soldering point to the pcb.
- At the T_S specified. For derating at $T_S >$ than specified, see Figure 1.
- Duration 5 seconds maximum at a distance of not less than 0.5mm from the device body and the same lead shall not be resoldered until 3 minutes have elapsed.

FIGURE 1 - PARAMETER DERATING INFORMATION

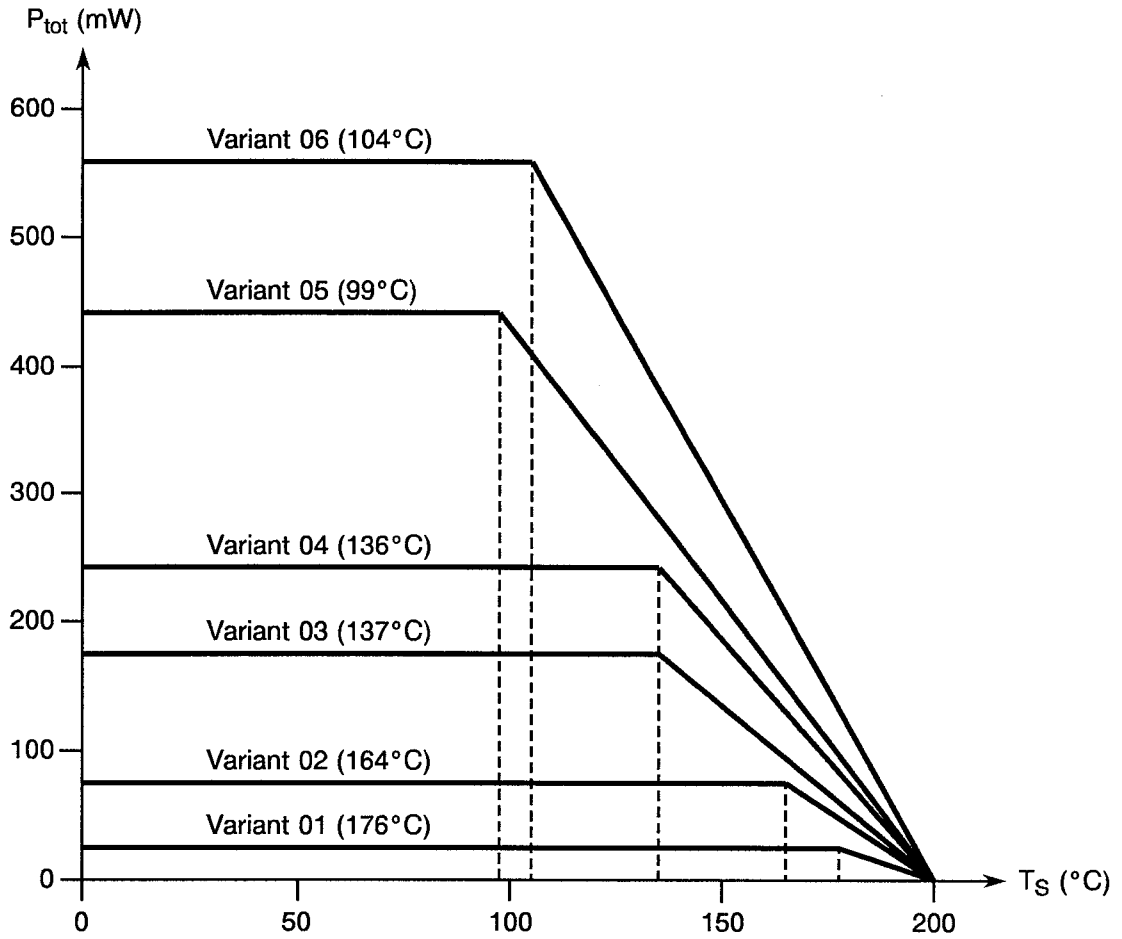

Power Dissipation versus Solder-Point Temperature

FIGURE 2 - PHYSICAL DIMENSIONS

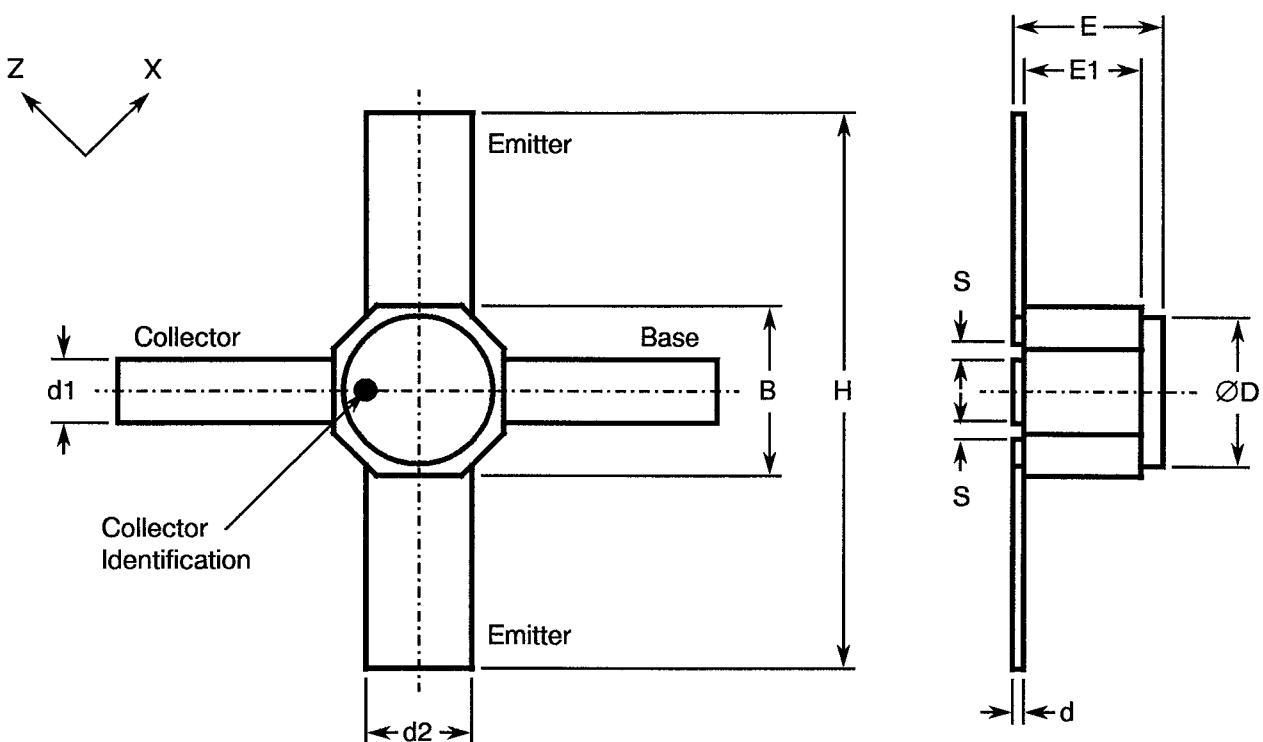

SYMBOL	MILLIMETRES		NOTES
	MIN.	MAX.	
B	1.68	1.88	
d	0.07	0.15	
d1	0.40	0.60	
d2	0.92	1.12	
ØD	1.55	1.85	
E	0.85	1.25	
E1	0.66	0.86	
H	4.00	4.40	
S	0.08	0.30	

FIGURE 3 - FUNCTIONAL DIAGRAM

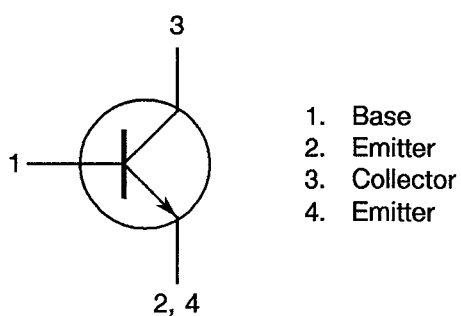

NOTES

1. The collector is marked with a black dot.

	<p style="text-align: center;">ESA/SCC Detail Specification No. 5611/006</p>		<p>PAGE 10 ISSUE 1</p>
---	--	--	----------------------------

4. REQUIREMENTS

4.1 GENERAL

The complete requirements for procurement of the transistors specified herein shall be as stated in this specification and ESA/SCC Generic Specification No. 5010 for Discrete Microwave Semiconductor Components. Deviations from the Generic Specification applicable to this specification only, are listed in Para. 4.2.

Deviations from the applicable Generic Specification and this Detail Specification, formally agreed with specific Manufacturers on the basis that the alternative requirements are equivalent to the ESA/SCC requirements and do not affect the components' reliability, are listed in the appendices attached to this specification.

4.2 DEVIATIONS FROM GENERIC SPECIFICATION

4.2.1 Deviations from Special In-process Controls

(a) Para. 5.3, Wafer Lot Acceptance: Shall be performed as a S.E.M. Inspection only.

4.2.2 Deviations from Final Production Tests (Chart II)

(a) Para. 6.2, Pre-burn-in: Shall not be performed.

(b) Para. 9.6, Constant Acceleration: Shall not be performed.

(c) Para. 9.7, Particle Impact Noise Detection (PIND) test: May be performed at any point after the position indicated in Chart II.

(d) Para. 9.14, Vibration, Variable Frequency: Shall not be performed.

4.2.3 Deviations from Burn-in and Electrical Measurements (Chart III)

(a) Para. 9.12, Radiographic Inspection: Shall be performed in X and Z axes only.

4.2.4 Deviations from Qualification Tests (Chart IV)

(a) Para. 9.13, Shock Test: Shall not be performed.

(b) Para. 9.14, Vibration: Shall not be performed.

(c) Para. 9.15, Constant Acceleration: Shall not be performed.

(d) Para. 9.20, Operating Life: Shall be performed at 1 temperature only on 30 pieces.

(e) Para. 9.23, Special Testing: Shall not be performed.

4.2.5 Deviations from Lot Acceptance Tests (Chart V)



(a) Para. 9.13, Shock Test: Shall not be performed.

(b) Para. 9.14, Vibration: Shall not be performed.

(c) Para. 9.15, Constant Acceleration: Shall not be performed.

(d) Para. 9.20, Operating Life: Shall be performed at 1 temperature only on 16 pieces.

(e) Para. 9.23, Special Testing: Shall not be performed.

 	<p style="text-align: center;">ESA/SCC Detail Specification No. 5611/006</p>		<p>PAGE 11 ISSUE 1</p>
---	--	--	----------------------------

4.3 MECHANICAL REQUIREMENTS

4.3.1 Dimension Check

The dimensions of the transistors specified herein shall be checked. They shall conform to those shown in Figure 2.

4.3.2 Weight

The maximum weight of the transistors specified herein shall be 0.03 grammes.

4.3.3 Terminal Strength

The requirements for terminal strength testing are specified in Section 9 of ESA/SCC Generic Specification No. 5010. The test conditions shall be as follows:-

(a) Condition: 'A' (Tension).

(b) Force: 2.23N.

(c) Duration: 5 seconds.

4.4 MATERIALS AND FINISHES

The materials and finishes shall be as specified herein. Where a definite material is not specified, a material which will enable the transistors specified herein to meet the performance requirements of this specification shall be used. Acceptance or approval of any constituent material does not guarantee acceptance of the finished product.

4.4.1 Case

The case shall be hermetically sealed and have a ceramic body.

4.4.2 Lead Material and Finish

The lid, end-cap and lead material shall be Type 'D' with Type '2' finish in accordance with the requirements of ESA/SCC Basic Specification No. 23500.

4.5 MARKING

4.5.1 General

The marking of components delivered to this specification shall be in accordance with the requirements of ESA/SCC Basic Specification No. 21700 and the following paragraphs. When the component is too small to accommodate all of the marking as specified, as much as space permits shall be marked and the marking information, in full, shall accompany the component in its primary package.

The information to be marked and the order of precedence, shall be as follows:-

(a) Collector Identification.

(b) The SCC Component Number.

(d) Traceability Information.

The primary package shall bear an "ESD Sensitive" label.



4.5.2 Collector Identification

Collector identification shall be as shown in Figures 2 and 3 of this specification.

4.5.3 The SCC Component Number

Each component shall bear the SCC Component Number which shall be constituted and marked as follows:

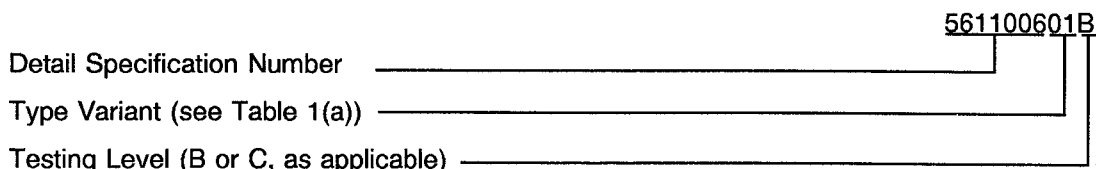

4.5.4 Traceability Information

Each component shall be marked in respect of traceability information in accordance with the requirements of ESA/SCC Basic Specification No. 21700.

4.6 ELECTRICAL MEASUREMENTS

4.6.1 Electrical Measurements at Room Temperature

The parameters to be measured at room temperature are scheduled in Table 2. Unless otherwise specified, the measurements shall be performed at $T_{amb} = +25 \pm 3 \text{ }^\circ\text{C}$.

4.6.2 Electrical Measurements at High and Low Temperatures

The parameters to be measured at high and low temperatures are scheduled in Table 3. Unless otherwise specified, the measurements shall be performed at $+150(+0 - 5)^\circ\text{C}$ and $-55(+5 - 0)^\circ\text{C}$.

4.6.3 Circuits for Electrical Measurements

Circuits for use in performing electrical measurements listed in Table 2 of this specification are shown in Figure 4.

4.7 BURN-IN TESTS

Burn-in shall be to Chart III(b).

4.7.1 Parameter Drift Values

The parameter drift values applicable to burn-in are specified in Table 4 of this specification. Unless otherwise stated, measurements shall be performed at $T_{amb} = +25 \pm 3 \text{ }^\circ\text{C}$. The parameter drift values (Δ) applicable to the scheduled parameters shall not be exceeded. In addition to these drift value requirements, the appropriate limit value specified for a given parameter in Table 2 shall not be exceeded.

4.7.2 Conditions for High Temperature Reverse Bias Burn-in

The requirements for high temperature reverse bias burn-in are specified in Section 7 of ESA/SCC Generic Specification No. 5010. The conditions for high temperature reverse bias burn-in shall be as specified in Table 5(a) of this specification.

 The logo for ESA/SCC, featuring a stylized 'e' inside a circle on the left and the letters 'SCC' in a bold, sans-serif font on the right.	ESA/SCC Detail Specification No. 5611/006		PAGE 13 ISSUE 1
---	--	--	--------------------

4.7.3 Conditions for Power Burn-in

The requirements for power burn-in are specified in Section 7 of ESA/SCC Generic Specification No. 5010. The conditions for power burn-in shall be as specified in Table 5(b) of this specification.

4.7.4 Electrical Circuits for High Temperature Reverse Bias Burn-in

The circuit for use in performing the high temperature reverse bias burn-in test is shown in Figure 5(a) of this specification.

4.7.5 Electrical Circuits for Power Burn-in

The circuit for use in performing the power burn-in test is shown in Figure 5(b) of this specification.



SEC

ESA/SCC Detail Specification

No. 5611/006

PAGE 14

ISSUE 1

TABLE 2 - ELECTRICAL MEASUREMENTS AT ROOM TEMPERATURE - d.c. PARAMETERS

No.	CHARACTERISTICS	SYMBOL	MIL-STD-750 TEST METHOD	TEST CONDITIONS	LIMITS		UNIT
					MIN.	MAX.	
1	Collector Cut-off Current	I_{CBO}	3036	$I_E = 0mA$ Variants 01-02: $V_{CB} = 10V$ Variants 03-04-05-06: $V_{CB} = 20V$	-	100	μA
2	Collector-Emitter Cut-off Current	I_{CEX}	3041	Variant 01: $V_{CE} = 8.0V, I_B = 0.1\mu A$ Variant 02: $V_{CE} = 8.0V, I_B = 0.2\mu A$ Variant 03: $V_{CE} = 12V, I_B = 0.5\mu A$ Variants 04-05-06: $V_{CE} = 12V, I_B = 1.0\mu A$	-	20 50 100 200	μA
3	Emitter Cut-off Current	I_{EBO}	3061	$V_{EB} = 2.0V, I_C = 0mA$	-	25	μA
4	Collector Cut-off Current	I_{CBO}	3036	$I_E = 0mA$ Variants 01-02: $V_{CB} = 8.0V$ Variants 03-04-05-06: $V_{CB} = 10V$	-	50	nA
5	Emitter Cut-off Current	I_{EBO}	3061	$V_{EB} = 1.0V, I_C = 0mA$	-	0.5	μA
6	D.C. Forward Current Transfer Ratio	h_{FE}	3076	Variants 01-02: $V_{CE} = 1.0V, I_C = 0.25mA$ Variant 03: $V_{CE} = 6.0V, I_C = 5.0mA$ Variant 04: $V_{CE} = 6.0V, I_C = 5.0mA$ Variant 05: $V_{CE} = 6.0V, I_C = 5.0mA$ Variant 06: $V_{CE} = 8.0V, I_C = 30mA$	30 55 55 55 50	175 175 170 160 175	
7	Base-Emitter Forward Voltage	V_{FBE}	-	Variant 01: $I_E = 3.0mA$ Variant 02: $I_E = 5.0mA$ Variant 03: $I_E = 15mA$ Variant 04: $I_E = 20mA$ Variants 05-06: $I_E = 30mA$	-	1.0	V



TABLE 2 - ELECTRICAL MEASUREMENTS AT ROOM TEMPERATURE - a.c. PARAMETERS

No.	CHARACTERISTICS	SYMBOL	MIL-STD-750 TEST METHOD	TEST CONDITIONS	LIMITS		UNIT
					MIN.	MAX.	
8	Collector-Base Capacitance	C_{CB}	3236	$I_E = 0\text{mA}$, $f = 1.0\text{MHz}$ Variant 01: $V_{CB} = 1.0\text{V}$ Variant 02: $V_{CB} = 1.0\text{V}$ Variant 03: $V_{CB} = 10\text{V}$ Variant 04: $V_{CB} = 10\text{V}$ Variant 05: $V_{CB} = 10\text{V}$ Variant 06: $V_{CB} = 10\text{V}$ Note 1	-	0.20	pF
9	Emitter-Base Capacitance	C_{EB}	3241	$V_{EB} = 0.5\text{V}$, $I_C = 0\text{mA}$ $f = 1.0\text{MHz}$ Variant 01 Variant 02 Variant 03 Variant 04 Variant 05 Variant 06 Note 2	-	0.19	pF
10	Insertion Power Gain	$ S_{21} ^2$	-	$f = 2.0\text{GHz}$ Variant 01: $V_{CE} = 3.0\text{V}$, $I_C = 2.0\text{mA}$ Variant 02: $V_{CE} = 3.0\text{V}$, $I_C = 6.0\text{mA}$ Variant 03: $V_{CE} = 5.0\text{V}$, $I_C = 10\text{mA}$ Variant 04: $V_{CE} = 5.0\text{V}$, $I_C = 15\text{mA}$ Variant 05: $V_{CE} = 5.0\text{V}$, $I_C = 20\text{mA}$ Variant 06: $V_{CE} = 5.0\text{V}$, $I_C = 40\text{mA}$ Notes 3 and 4	6.5	-	dB
11	Noise Figure	NF	-	$f = 2.0\text{GHz}$ Variant 01: $V_{CE} = 3.0\text{V}$, $I_C = 2.0\text{mA}$ Variant 02: $V_{CE} = 3.0\text{V}$, $I_C = 2.0\text{mA}$ Variant 03: $V_{CE} = 5.0\text{V}$, $I_C = 4.0\text{mA}$ Variant 04: $V_{CE} = 5.0\text{V}$, $I_C = 5.0\text{mA}$ Variant 05: $V_{CE} = 5.0\text{V}$, $I_C = 8.0\text{mA}$ Variant 06: $V_{CE} = 5.0\text{V}$, $I_C = 15\text{mA}$ Note 5	-	3.2	dB

NOTES: See Page 16.

TABLE 2 - ELECTRICAL MEASUREMENTS AT ROOM TEMPERATURE - a.c. PARAMETERS (CONT'D)

No.	CHARACTERISTICS	SYMBOL	MIL-STD-750 TEST METHOD	TEST CONDITIONS	LIMITS		UNIT
					MIN.	MAX.	
12	Maximum Available/ Stable Gain	MAG/ MSG	-	f = 2.0GHz Variant 01: $V_{CE} = 3.0V, I_C = 2.0mA$ Variant 02: $V_{CE} = 3.0V, I_C = 6.0mA$ Variant 03: $V_{CE} = 5.0V, I_C = 10mA$ Variant 04: $V_{CE} = 5.0V, I_C = 15mA$ Variant 05: $V_{CE} = 5.0V, I_C = 20mA$ Variant 06: $V_{CE} = 5.0V, I_C = 40mA$ Notes 3 and 6	12 13 13.5 13.5 12.5 12.5	- - - - - -	dB
13	Gain Bandwidth Product	f_T	-	f = 500MHz Variant 01: $V_{CE} = 3.0V, I_C = 2.0mA$ Variant 02: $V_{CE} = 3.0V, I_C = 6.0mA$ Variant 03: $V_{CE} = 5.0V, I_C = 10mA$ Variant 04: $V_{CE} = 5.0V, I_C = 15mA$ Variant 05: $V_{CE} = 5.0V, I_C = 20mA$ Variant 06: $V_{CE} = 5.0V, I_C = 40mA$ Note 3	7.0	- - - - - -	GHz
14	Output Power	P_{OUT}	-	$V_{CE} = 5.0V, f = 2.0GHz$ $Z_S = Z_L = 50\Omega$ Variant 05: $I_C = 30mA, P_{IN} = 7.0dBm$ Variant 06: $I_C = 50mA, P_{IN} = 10dBm$	13.5 16.5	- -	dBm

NOTES

1. The emitter is connected to the ground terminal.
2. The collector is connected to the ground terminal.
3. Measured in a 50Ω system (S-parameter).
4. Small signal measurement.
5. Input tuned for NF min.
6. MAG if $K \geq 1.0$; MSG if $K < 1.0$.

TABLE 3(a) - ELECTRICAL MEASUREMENTS AT HIGH TEMPERATURE

No.	CHARACTERISTICS	SYMBOL	MIL-STD-750 TEST METHOD	TEST CONDITIONS	LIMITS		UNIT
					MIN.	MAX.	
4	Collector Cut-off Current	I_{CBO}	3036	$I_E = 0mA$ Variants 01-02: $V_{CB} = 8.0V$ Variants 03-04-05-06: $V_{CB} = 10V$	-	10	μA

TABLE 3(b) - ELECTRICAL MEASUREMENTS AT LOW TEMPERATURE

No.	CHARACTERISTICS	SYMBOL	MIL-STD-750 TEST METHOD	TEST CONDITIONS	LIMITS		UNIT
					MIN.	MAX.	
6	D.C. Forward Current Transfer Ratio	h_{FE}	3076	Variants 01-02: $V_{CE} = 1.0V, I_C = 0.25mA$ Variants 03-04-05: $V_{CE} = 6.0V, I_C = 5.0mA$ Variant 06: $V_{CE} = 8.0V, I_C = 30mA$	10	-	-
					30	-	
					30	-	



FIGURE 4 - CIRCUITS FOR ELECTRICAL MEASUREMENTS

FIGURE 4(a) - TEST SET-UP FOR S-PARAMETER MEASUREMENT

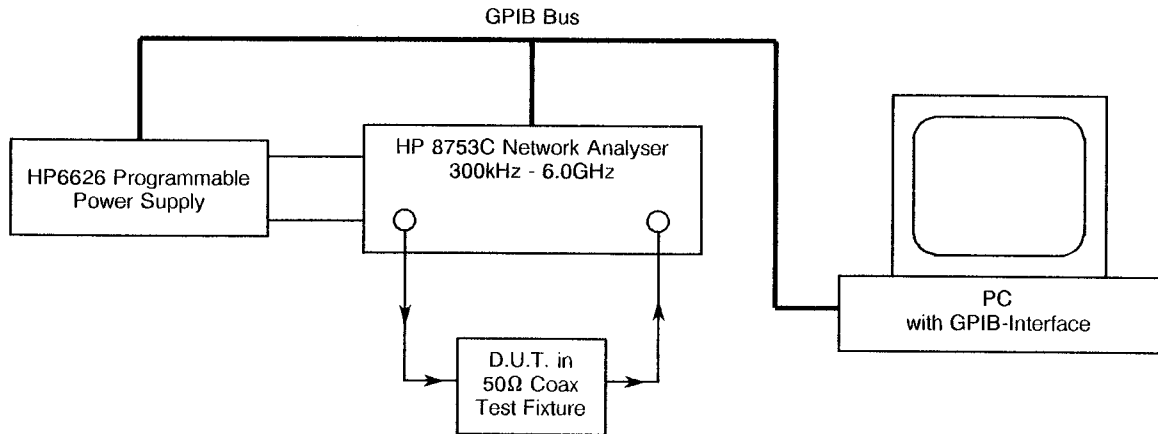

FIGURE 4(b) - TEST SET-UP FOR NOISE FIGURE MEASUREMENT

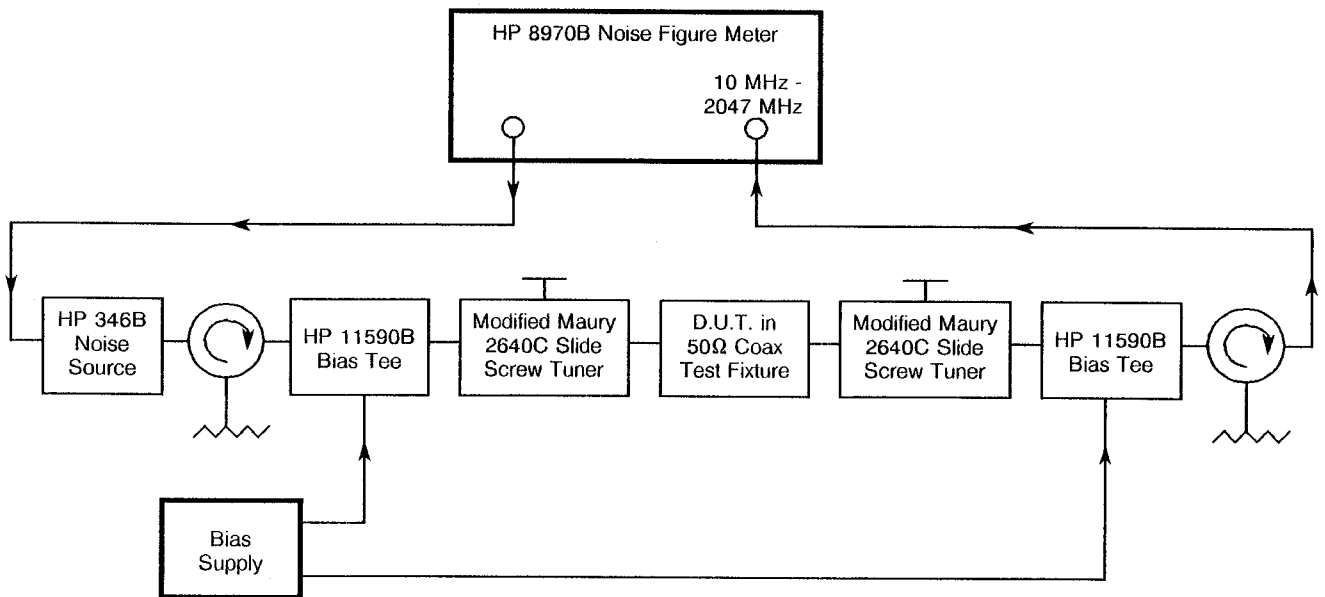

TABLE 4 - PARAMETER DRIFT VALUES

No.	CHARACTERISTICS	SYMBOL	SPEC. AND/OR TEST METHOD	TEST CONDITIONS	CHANGE LIMITS (Δ)	UNIT
4	Collector Cut-off Current	I_{CBO}	As per Table 2	As per Table 2	± 10 or (2) ± 100	nA %
5	Emitter Cut-off Current	I_{EBO}	As per Table 2	As per Table 2	± 10 or (2) ± 100	nA %
6	D.C. Forward Current Transfer Ratio	h_{FE}	As per Table 2	As per Table 2	± 10	%
7	Base-Emitter Forward Voltage	V_{FBE}	As per Table 2	As per Table 2	± 10	%

NOTES

1. $\Delta 1 = \Delta 2 = \Delta 3$.
2. Whichever is greater, referred to the initial measurement.

TABLE 5(a) - CONDITIONS FOR HIGH TEMPERATURE REVERSE BIAS BURN-IN

No.	CHARACTERISTICS	SYMBOL	CONDITIONS	UNIT
1	Case Temperature	T_{case}	+ 150(+ 0 – 5)	°C
2	Collector-Emitter Voltage	V_{CES}	Variants 01-02: 12 Variants 03-04-05-06: 16	V

TABLE 5(b) - CONDITIONS FOR POWER BURN-IN AND OPERATING LIFE TESTS

No.	CHARACTERISTICS	SYMBOL	CONDITIONS	UNIT
1	Ambient Temperature	T_{amb}	Variants 01-02: + 175(+ 0 – 5) Variant 03: + 125(+ 0 – 5) Variants 04-05-06: + 100(+ 0 – 5)	°C
2	Power Dissipation	P_{tot}	Variant 01: 26.2 Variant 02: 41.7 Variant 03: 147 Variant 04: 247 Variant 05: 267 Variant 06: 317 (Note 1)	mW
3	Collector-Emitter Voltage	V_{CE}	Variants 01-02: 6.4 Variants 03-04-05-06: 9.6	V

NOTES

1. Because the components are clamped within the Burn-in fixture, in order to achieve $T_J = +200^\circ\text{C}$, $R_{TH(J-A)} = 150^\circ\text{C/W}$ must be considered.



FIGURE 5(a) - ELECTRICAL CIRCUIT FOR HIGH TEMPERATURE REVERSE BIAS BURN-IN

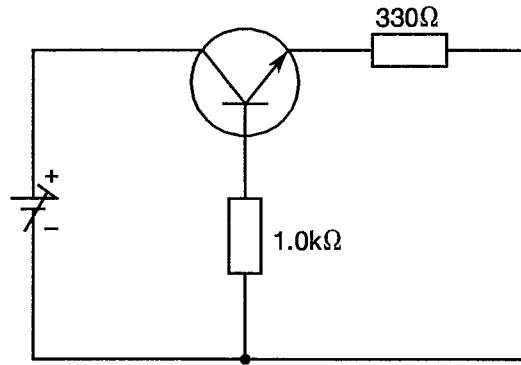
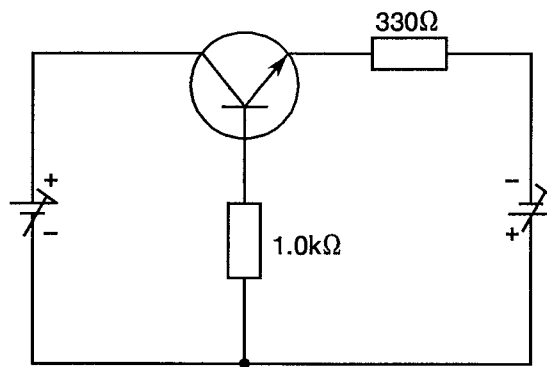



FIGURE 5(b) - ELECTRICAL CIRCUIT FOR POWER BURN-IN AND OPERATING LIFE TESTS



	<p style="text-align: center;">ESA/SCC Detail Specification No. 5611/006</p>	<p style="text-align: right;">PAGE 22 ISSUE 1</p>
--	--	---

4.8 ENVIRONMENTAL AND ENDURANCE TESTS (CHARTS IV AND V OF ESA/SCC GENERIC SPECIFICATION No. 5010)

4.8.1 Electrical Measurements on Completion of Environmental Tests

The parameters to be measured on completion of environmental tests are scheduled in Table 2. Unless otherwise stated, the measurements shall be performed at $T_{amb} = +25 \pm 3$ °C.

4.8.2 Electrical Measurements at Intermediate Points and on Completion of Endurance Tests

The parameters to be measured at intermediate points and on completion of endurance testing are scheduled in Table 6 of this specification. Unless otherwise stated, the measurements shall be performed at $T_{amb} = +25 \pm 3$ °C.

4.8.3 Conditions for Operating Life Tests (Part of Endurance Testing)

The requirements for operating life testing are specified in Section 9 of ESA/SCC Generic Specification No. 5010. The conditions for operating life testing are specified in Table 5(b) of this specification.

4.8.4 Electrical Circuits for Operating Life Tests

The circuit for use in performing the operating life test shall be the same as shown in Figure 5(b) for Power Burn-in.

4.9 TOTAL DOSE IRRADIATION TESTING

Not applicable.

4.10 SPECIAL TESTING

Not applicable.

**TABLE 6 - ELECTRICAL MEASUREMENTS AT INTERMEDIATE POINTS
AND ON COMPLETION OF ENDURANCE TESTING**



No.	CHARACTERISTICS	SYMBOL	SPEC. AND/OR TEST METHOD	TEST CONDITIONS	CHANGE LIMITS (Δ)	LIMITS		UNIT
						MIN.	MAX.	
1	Collector Cut-off Current	I_{CBO}	As per Table 2	As per Table 2	-	As per Table 2		μA
4	Collector Cut-off Current	I_{CBO}	As per Table 2	As per Table 2	-	As per Table 2		μA
5	Emitter Cut-off Current	I_{EBO}	As per Table 2	As per Table 2	-	As per Table 2		μA
6	D.C. Forward Current Transfer Ratio	h_{FE}	As per Table 2	As per Table 2	-	As per Table 2		-
7	Base-Emitter Forward Voltage	V_{FBE}	As per Table 2	As per Table 2	-	As per Table 2		V

FIGURE 6 - BIAS CONDITIONS FOR IRRADIATION TESTING

Not applicable.

TABLE 7 - ELECTRICAL MEASUREMENTS DURING AND ON COMPLETION OF IRRADIATION TESTING

Not applicable.

 	<p>ESA/SCC Detail Specification No. 5611/006</p>		<p>PAGE 24 ISSUE 1</p>
--	--	--	----------------------------

APPENDIX 'A'

Page 1 of 1

AGREED DEVIATIONS FOR SIEMENS (D)

ITEMS AFFECTED	DESCRIPTION OF DEVIATIONS
Para. 4.2.3	Para. 9.12, Radiographic Inspection: Exposure 100kV, duration 5 minutes may be used.
Para. 4.2.5	Para. 9.5, Thermal Shock and Para. 9.16, Moisture Resistance: May be done in sequence on all 6 components of the Environmental/Mechanical subgroups.