



europaean space agency  
agence spatiale europ eennne

Pages 1 to 34

**EVALUATION TEST PROGRAMME FOR  
MONOLITHIC MICROWAVE  
INTEGRATED CIRCUITS (MMICs)  
ESA/SCC Basic Specification No. 2269010**



**space components  
coordination group**

Issue/Rev.	Date	Approved by	
		SCCG Chairman	ESA Director General or his Deputy
Issue 1	October 1997	<i>Sam Smith</i>	<i>A. ...</i>



ESA/SCC Basic Specification  
No. 2269010

PAGE 2

ISSUE 1

**DOCUMENTATION CHANGE NOTICE**

Rev. Letter	Rev. Date	Reference	CHANGE Item	Approved DCR No.

**TABLE OF CONTENTS**

	<u>Page</u>
<b>1. <u>PURPOSE</u></b>	<b>5</b>
<b>2. <u>APPLICABLE DOCUMENTS</u></b>	<b>5</b>
2.1 ESA/SCC Specifications	5
2.2 Other (Reference) Documents	5
<b>3. <u>PROCEDURE</u></b>	<b>5</b>
3.1 General	5
3.2 Evaluation of a Standard Component	6
3.3 Evaluation of a Capability Domain	6
<b>4. <u>SAMPLE SELECTION, TEST DEFINITION AND MANUFACTURING</u></b>	<b>6</b>
4.1 Selection of Components for Evaluation Testing	6
4.1.1 Qualification Testing	6
4.1.2 Capability Approval	7
4.2 Evaluation Test Programme Definition	7
4.3 Further Evaluation Testing	7
4.4 Detail Specifications and Test Documents	8
4.5 Inspection Rights	8
4.6 Manufacturing	8
4.6.1 General	8
4.6.2 Assembly of Components	8
4.6.3 Assembly of Test Structures	8
<b>5. <u>INSPECTION</u></b>	<b>8</b>
5.1 General	8
5.1.1 Components and RIC Test Structures	9
5.1.2 TCV and DEC Test Structures	9
5.2 Dimensions	9
5.3 Weight	9
5.4 Electrical Measurements	9
5.5 External Visual Inspection	9
5.6 Particle Impact Noise Detection (PIND)	9
5.7 Radiographic Inspection	9
5.8 Hermeticity	9
5.9 Marking and Serialisation	9
5.10 Materials and Finishes	10
5.11 Completion of Inspection	10
<b>6. <u>INITIAL MEASUREMENTS AND DESIGN SYSTEM ASSESSMENT</u></b>	<b>10</b>
6.1 Initial Electrical Measurements	10
6.2 Thermal Analysis	10
6.3 Specific Dynamic Measurements	10
6.4 Design System Assessment	11



	<u>Page</u>
<b>7. EVALUATION TESTING</b>	<b>11</b>
7.1 Evaluation Test Programme For Qualification Testing	11
7.1.1 Family of Components	11
7.1.2 Group 1 - Control Group	11
7.1.3 Group 2 - Aging Tests	11
7.1.4 Group 3 - Destructive Tests	13
7.2 Evaluation Test Programme For Capability Approval	17
7.2.1 Group 1 - TCV Test Programme	17
7.2.2 Group 2 - DEC Test Programme	18
7.2.3 Group 3 - RIC Test Programme	19
7.3 Evaluation Results	21
<b>8. DATA DOCUMENTATION</b>	<b>22</b>
8.1 General Requirements	22
8.1.1 Qualification Testing	22
8.1.2 Capability Approval	22
8.2 Cover Sheets(s)	24
8.3 List of Equipment Used	24
8.4 List of Test References	24
8.5 Sample Selection	24
8.6 Manufacturing Data	24
8.7 Inspection Data	24
8.8 Initial Measurements Data	24
8.8.1 Initial Electrical Measurements Data	24
8.8.2 Thermal Analysis Data	24
8.8.3 Specific Dynamic Measurements Data	24
8.8.4 Design System Assessment	25
8.9 Evaluation Data	25
8.9.1 Qualification Testing	25
8.9.2 Capability Approval	26
8.10 Summary of Results and Conclusions	28
<b><u>CHARTS</u></b>	
IA EVALUATION TEST PROGRAMME FOR QUALIFICATION TESTING	29
IB EVALUATION TEST PROGRAMME FOR CAPABILITY APPROVAL	30
II ACCELERATED ELECTRICAL ENDURANCE TEST	33
III TEMPERATURE STORAGE TESTS	34

**1. PURPOSE**

The purpose of this specification is to establish the procedure to be followed in the evaluation of device capabilities and technologies as required for space applications and thereby to anticipate, as far as possible, device behaviour during qualification testing and capability approval. Therefore, the aim of such testing shall be to overstress specific characteristics of the device concerned with a view to the detection of possible failure modes. Additionally, a detailed destructive physical analysis shall be performed to detect any design and construction defects which may affect the reliability of the device and to facilitate failure analysis activities. The evaluation shall also include a check of the susceptibility of the device to ESD damage and radiation sensitivity.

**2. APPLICABLE DOCUMENTS****2.1 ESA/SCC SPECIFICATIONS**

The following ESA/SCC specifications are applicable to the extent specified herein. The relevant issues shall be those in effect on the date of performance of evaluation testing.

No. 9010, Monolithic Microwave Integrated Circuits (MMICs).

No. 20400, Internal Visual Inspection.

No. 20500, External Visual Inspection.

No. 20900, Radiographic Inspection.

No. 22900, Total Dose Steady State Irradiation Test Method.

No. 24300, Requirements for the Capability Approval of Electronic Component Technologies for Space Application.

No. 23800, Electrostatic Discharge Sensitivity Test Method.

Unless otherwise stated herein, reference within the text of this specification to "the Detail Specification" shall mean the relevant ESA/SCC Detail Specification.

**2.2 OTHER (REFERENCE) DOCUMENTS**

ESA PSS-01-702, A Thermal Vacuum Test for the Screening of Space Materials.

IEC Publication No. 68 - Basic Environmental Testing Procedures.

MIL-STD-750 - Test Methods and Procedures for Semiconductor Devices.

MIL-STD-883 - Test Methods and Procedures for Microelectronics.

**3. PROCEDURE****3.1 GENERAL**

The tests specified in each programme shall be performed in the sequence shown in Charts IA or IB. All results shall be recorded and failed devices submitted to a failure analysis. Probable failure modes and mechanisms shall be determined.

The evaluation test programme shall be performed, under the supervision of the Qualifying Space Agency (QSA) for whom the evaluation of the device concerned is required, by the Manufacturer or at a test laboratory approved by the QSA.



### 3.2 EVALUATION OF A STANDARD COMPONENT

The evaluation test programme shall consist of:-

- (a) Sample selection (Para. 4.1).
- (b) Evaluation test programme definition (Para. 4.2).
- (c) Inspection (Para. 5).
- (d) Initial measurements (Para. 6).
- (e) Evaluation testing and review (Para. 7.1).

### 3.3 EVALUATION OF A CAPABILITY DOMAIN

The manufacturer shall supply a draft capability abstract to the QSA in accordance with ESA/SCC Basic Specification No. 24300, Para. 6.1.

The evaluation test programme shall consist of:-

- (a) Definition, review and agreement of the test structures (Para. 4.1.2.1).
- (b) Evaluation test programme definition (Para. 4.2).
- (c) Assembly of the test structures (Para. 4.6.3).
- (d) Inspection (Para. 5).
- (e) Initial Measurements and design system assessment (Para. 6).
- (f) Evaluation testing and review (Para. 7.2).

## 4. SAMPLE SELECTION, TEST PROGRAMME DEFINITION AND MANUFACTURING

### 4.1 SELECTION OF COMPONENTS FOR EVALUATION TESTING

Standard components or test structures shall be selected from more than one lot but no more than 3 lots at the Manufacturer to be evaluated, to form a homogeneous sample. This requirement may be reviewed on a case by case basis.



#### 4.1.1 Qualification Testing

The number of components chosen for qualification testing shall depend on whether a single component type or a family of parts is evaluated and the number of component types chosen to represent the family.

For qualification testing, not less than 83 specimens shall be used for each test programme.

The component types chosen to represent a family shall cover the range of components to be evaluated and be representative of the different package and pin configurations under consideration. They shall also be the most suitable for highlighting those characteristics and parameters that are pertinent to an investigation into failure modes and weaknesses.

The sample selection shall be as specified by, or as agreed with, the QSA.

		<p>ESA/SCC Basic Specification No. 2269010</p>	<p>PAGE 7 ISSUE 1</p>
---	---	--	---------------------------

#### 4.1.2 Capability Approval

##### 4.1.2.1 Definition, Design Review and Agreement of the Test Structures

The Manufacturer shall propose to the QSA, the detail and rationale for the TCV, DEC and RIC test structures he intends to submit to the evaluation programme. To this end, the Manufacturer shall demonstrate that the proposed test structures:

- Fulfil the requirements of Section 5 and,
- Are appropriate to assess the capability domain and to perform the evaluation test programme.

Draft inspection documents and the design compliance matrix shall be submitted to the QSA following the design review.

##### 4.1.2.2 Test Structure Sampling

The number of test structures chosen for evaluation testing for capability approval to cover each domain shall be selected in accordance with ESA/SCC Basic Specification No. 23400 and Para. 5 of the relevant ancillary specification and shall be as follows:-

Technology characterisation vehicles (TCVs) : 134.  
Dynamic evaluation circuits (DECs) : 74.  
Representative integrated circuits (RICs) : 69.

The sample selection shall be as specified by, or as agreed with, the QSA.

#### 4.2 EVALUATION TEST PROGRAMME DEFINITION

The evaluation test programme for components and technologies covered by this specification shall generally consist of the tests and subgroups given in Charts IA and IB of this specification. The requirements specified therein may be reduced by the QSA if it is demonstrated that particular requirements have already been covered in a different but equivalent evaluation, qualification or capability approval programme.

To this end, the Manufacturer shall submit to the QSA the evaluation test programme with justification for any deviation. The Manufacturer shall present in the evaluation test programme the measurements, tests and methods that shall be applied during the evaluation test programme. As a minimum the following items shall be addressed:

- Inspection after process (electrical measurements, visual inspection, marking and serialisation, etc...).
- Thermal analysis (identification of cell temperatures during life tests).
- High and low temperature characterisation (technology thermal behaviour).
- Electrical measurements.
- Failure criteria.
- Failure analysis methods.

The programme shall be reviewed and approved by the QSA prior to the start of the evaluation activity.

#### 4.3 FURTHER EVALUATION TESTING

The above mentioned quantities shall be submitted to the full evaluation procedure whenever a new technology or extension of the domain boundaries has been applied to the devices concerned, where there is insufficient experience in their production.

##### **N. B.**

Materials used in the production of the samples above must meet the requirements of Para. 5.10 of this specification.



#### 4.4 DETAIL SPECIFICATIONS AND TEST DOCUMENTS

Should a Detail Specification or Test Document for the device(s) to be evaluated not exist, the Manufacturer shall prepare such a document in accordance with the established ESA/SCC format and submit it to the appropriate QSA for review.

#### 4.5 INSPECTION RIGHTS

The QSA reserves the right to inspect the devices processed for evaluation purposes at any time.

#### 4.6 MANUFACTURING

##### 4.6.1 General

The components and test structures shall be produced as defined below.

These components or test structures shall not have been submitted to any screening or burn-in, but must have been manufactured in conformity with high reliability practice and an established Process Identification Document (P.I.D.) or an identifiable process which shall form the basis for a P.I.D.

The manufacturer shall notify the QSA at least 2 working weeks prior to the commencement of pre-encapsulation inspection.

Progress of the components and test structures shall be observed closely and recorded, together with an analysis of any reject.

Records of manufacturing, process measurements (PCM) and the results of the inspections after processes plus a chart showing the numbers in/out and the failure cause for each fabrication stage shall be submitted to the QSA.

If more than one lot is used, traceability to the different lots shall be maintained.

##### 4.6.2 Assembly of Components

Devices shall be mounted in their normal packages.

##### 4.6.3 Assembly of Test Structures

Devices shall be mounted in suitable packages (DIL, discrete and/or microwave modules).

#### 5. INSPECTION

##### 5.1 GENERAL

The components and test structures shall be checked to verify their suitability for the Evaluation Test Programmes. Defects or deviations from the established ESA/SCC requirements may invalidate the evaluation if not previously agreed with the QSA. For each measurement or inspection performed, the results shall be summarised in terms of quantity tested, quantity passed and quantity rejected. If components or test structures are rejected, they shall be replaced and the reason for rejection shall be clearly identified.





### 5.1.1 Components and RIC Test Structures

Components and RIC test structures shall be submitted to all of the tests and inspections specified in Paras 5.2 to 5.9 of this specification.

### 5.1.2 TCV and DEC Test Structures

TCV and DEC test structures shall normally be submitted only to:-

- (a) Electrical measurements (Para. 5.4).
- (b) Hermeticity (Para. 5.8).
- (c) Serialisation and Traceability (Para. 5.9).

However, if considered necessary, other tests and inspections may also be specified.

### 5.2 DIMENSIONS (100%)

All components and RIC test structures shall be inspected in accordance with Figure 2 of the draft Detail Specification or Test Document (go-no-go). Where gauges exist for performance of measurements, these may be used. For packages with a high pin count, the measurements may be performed using a sampling scheme which shall be approved by the QSA.

### 5.3 WEIGHT (100%)

All components and RIC test structures shall be weighed.

Any components and RIC test structures that exceed the weight defined in the draft Detail Specification or Test Document shall be rejected and replaced.

### 5.4 ELECTRICAL MEASUREMENTS (100%)

These measurements shall be performed in accordance with the draft Table 2 of the Detail Specification or Test Document at an ambient temperature of  $+22 \pm 3^\circ\text{C}$  or  $+25 \pm 3^\circ\text{C}$  (go-no-go).

### 5.5 EXTERNAL VISUAL INSPECTION (100%)

All components and RIC test structures shall be inspected in accordance with ESA/SCC Basic Specification No. 20500.

### 5.6 PARTICLE IMPACT NOISE DETECTION (PIND) (100%)

All components and RIC test structures shall be tested in accordance with the requirements of ESA/SCC Generic Specification No. 9010, Para. 9.12.

### 5.7 RADIOGRAPHIC INSPECTION (100%)

All components and RIC test structures shall be inspected in accordance with ESA/SCC Basic Specification No. 20900. Additional axes to those specified in the relevant ancillary specification of ESA/SCC Basic Specification No. 20900 may be radiographed if, by so doing, it is possible to observe any faults.

### 5.8 HERMETICITY (100%)

Fine and gross leak tests shall be performed on all components and RIC test structures in accordance with the requirements of ESA/SCC Generic Specification No. 9010, Para. 9.13.

### 5.9 MARKING AND SERIALISATION (100%)

All components and RIC test structures shall be marked and serialised in accordance with the standard procedures of the Manufacturer concerned. Traceability of the different lots shall be possible.



#### 5.10 MATERIALS AND FINISHES

All non-metallic materials and finishes, that are not within a hermetically sealed enclosure, of the components and RIC test structures specified herein shall be tested in accordance with ESA PSS-01-702 to verify its outgassing requirements, unless relevant data is available.

Specific requirements for materials and finishes are specified in the draft Detail Specifications and Test Documents.

#### 5.11 COMPLETION OF INSPECTION

At the completion of inspection, a formal review shall be conducted of the quantity and type of reject encountered and an assessment made of the probability of a satisfactory evaluation if pursued to the conclusion of the test programme. If sufficient confidence cannot be established at this time, work on the Evaluation Lot should be terminated.

### 6. INITIAL MEASUREMENTS AND DESIGN SYSTEM ASSESSMENT

#### 6.1 INITIAL ELECTRICAL MEASUREMENTS (100% READ AND RECORD)

These measurements shall be performed in accordance with, but not be limited to, Tables 2 and 3 of the relevant draft Detail Specifications or Test Documents. All characteristics shall be recorded against serial numbers.

#### 6.2 THERMAL ANALYSIS

This test could be destructive and shall be performed on 5 of each type of device. The purpose of this test is to investigate thermal impedance and "hot-spot".

On TCVs and DECAs, the tests shall be performed in accordance with MIL-STD-750 as follows:-

- (a) Test Method 3104 : For GaAs and JFETS.
- (b) Test Method 3131 : Bipolar devices.

For RICs and components, the tests shall be performed as per Para. 8.2.1 of ESA/SCC Basic Specification No. 2439010. This test method may also be used for TCVs and DECAs to supplement the previously specified test methods if insufficient information is obtained using these test methods.

For power devices (output power at 1dB compression equal to or more than 20dBm), measurements shall be performed and "hot-spot" and thermal impedance under nominal RF conditions shall be evaluated.



#### 6.3 SPECIFIC DYNAMIC MEASUREMENTS

These measurements shall be performed on 5 TCVs or DECAs. The purpose of these tests is to evaluate parasitic effects (traps) affecting the operation of devices. These tests shall be agreed between the QSA and the Manufacturer.

The tests recommended are:

- For power FETs: Gate and drain lag effects.
- For low noise FETs: Transconductance and output conductance.

Two of the devices shall be placed in Group 1 of Chart IA, the three others shall be placed equally under accelerated electrical endurance tests (Group 2A of Chart IA). The measurements should be repeated after ageing tests in order to analyse any degradations which could occur.

 	<p style="text-align: center;">ESA/SCC Basic Specification No. 2269010</p>	<p style="text-align: right;">PAGE 11 ISSUE 1</p>
---	--	---

#### 6.4 Design System Assessment

The purpose of this activity is to assess the validity of the design models. RF measurements of DEC and RIC, obtained during Para. 5.4 shall be presented at a critical design review and compare with the simulation data already supplied during the design review specified in Para. 4.1.2.1 of this specification.

If this comparison shows major discrepancies between simulation and measurement data, the Manufacturer shall submit a plan to improve/verify the design and/or modelisation and/or layout rules. New RIC design may be requested and the capability domain may be reviewed.

### 7. EVALUATION TESTING

Evaluation testing shall be performed for qualification testing in accordance with Para. 7.1 and for capability approval in accordance with Para. 7.2 of this specification.

The evaluation tests shall be performed as specified in Charts IA and IB. The components and test structures shall be randomly divided into groups and their associated subgroups in the proportions indicated in the Charts.

All failed components and test structures shall be analysed. The depth of analysis shall depend upon the circumstances in which failure occurred and on whether useful information may be gained. As a minimum, the failure mode shall be determined in each case.

#### 7.1 EVALUATION TEST PROGRAMME FOR QUALIFICATION TESTING (CHART IA)

##### 7.1.1 Family of Components

When a family of components is under investigation, the variations within that family must be represented in each group/subgroup.

##### 7.1.2 Group 1 - Control Group

This group shall consist of 5 devices. Electrical measurements shall be performed on the 5 components in accordance with Table 3 of the draft Detail Specification. These devices are to be retained as a reference and may be used for verifying the test set-up prior to making electrical or RF measurements on devices from the various other groups in the evaluation. At least 2 devices of this group shall be tested for specific dynamic measurements.

##### 7.1.3 Group 2 - Ageing Tests

###### 7.1.3.1 General

This group shall be randomly divided into two subgroups in the proportions indicated in Chart IA .

###### 7.1.3.2 Subgroup 2A, Accelerated Electrical Endurance Test.

###### 7.1.3.2.1 Selection of the Components

This group shall consist of 36 components, divided into three subgroups as specified in Chart IA. In these tests, junction temperature shall not exceed +225°C and the tests shall be performed up to 4000 hours or 50% of defects.

	<p style="text-align: center;">ESA/SCC Basic Specification No. 2269010</p>	<p>PAGE 12 ISSUE 1</p>
---	--	----------------------------

#### 7.1.3.2.2 Test Conditions

Unless otherwise specified, the test sequence shall be in accordance with Chart II and as specified in the evaluation test programme given in Para. 4.2 of this specification. As an example, the following conditions could be applicable:

- Test 1,  $T_j = +175^{\circ}\text{C}$ , bias condition 1.
- Test 2,  $T_j = +225^{\circ}\text{C}$ , bias condition 1.
- Test 3,  $T_j = +225^{\circ}\text{C}$ , bias condition 2.

Bias condition 1 may be the most stringent biasing in order to investigate the effect of high electrical fields.

Bias condition 2 may be the most stringent biasing in order to investigate the effect of high current density.

#### 7.1.3.2.3 Intermediate and Final Electrical Measurements

Intermediate electrical measurements shall be performed, where applicable, at the following times :  $48 \pm 8$  hrs,  $168 \pm 24$  hrs,  $500 \pm 24$  hrs,  $1000 \pm 24$  hrs and  $2000 \pm 24$  hrs. RF measurements may be required to be made during intermediate measurements and this will be determined by technology and performance requirements on a case-by-case basis.

Final electrical measurements shall be performed at the specified end point  $\pm 24$  hrs and shall include RF measurements.

#### 7.1.3.2.4 Failure Analysis

Devices under test showing signs of failure shall be removed for investigation before the failure becomes catastrophic, but it may not be necessary for the devices to be removed from test as soon as they exceed one or more failure criteria.

Failure criteria shall be based on both DC and RF parameters.

#### 7.1.3.2.5 Analysis of Subgroup 2A

The results of analysis of Subgroup 2A shall be presented to the QSA as follows:

- Functional failures shall be recorded on graphs for each subgroup together with the quantity of failures.
- Dispersion and drift of the different parameters listed in Table 6 of the Detail Specification.
- Initial, intermediate and final electrical measurements plotted for each intermediate time.
- Influence of the biasing on the life of the device.
- Evaluated activation energy if data is sufficient.

#### 7.1.3.3 Subgroup 2B - Temperature Storage Tests

##### 7.1.3.3.1 Selection of Components

This group shall consist of 12 components, divided into two subgroups as specified in Chart IA. These tests shall be performed in order to evaluate high activation energy. The temperature shall not exceed  $+285^{\circ}\text{C}$  and tests shall be performed up to 1000 hours or 50% of defects.

	<p style="text-align: center;">ESA/SCC Basic Specification No. 2269010</p>	<p>PAGE 13 ISSUE 1</p>
---	--	----------------------------

#### 7.1.3.3.2 Test Conditions

Unless otherwise specified, the test sequence shall be in accordance with Chart III. Devices shall be stored at 2 different temperatures T1 and T2 as specified in the evaluation test programme.

#### 7.1.3.3.3 Intermediate or Final Electrical Measurements

See Para. 7.1.3.2.3.

#### 7.1.3.3.4 Failure Analysis

See Para. 7.1.3.2.4.

#### 7.1.3.3.5 Analysis of Subgroup 2B

See Para. 7.1.3.2.5 (Influence of the biasing is not applicable).

### 7.1.4 Group 3 - Destructive Tests

This group shall be randomly divided into three subgroups as specified in Chart IA.

#### 7.1.4.1 Subgroup 3A - Radiation Testing and Constructional Analysis

##### 7.1.4.1.1 Radiation Analysis

The purpose of this test is to investigate the device sensitivity to radiation. 10 devices shall be submitted to radiation analysis in accordance with ESA/SCC Basic Specification No. 22900 using an electron source. Devices shall be measured at the end of the test and one week later.

##### 7.1.4.1.2 Constructional Analysis

This test shall be performed on the devices which have been submitted to radiation analysis. They shall be divided randomly into 3 further subgroups as follows:

- 2 = Reserve for repeat tests.
- 2 = Internal water vapour content.
- 6 = Internal visual inspection.

These 6 devices shall also be used to provide 2 parts for bond strength/die shear testing and to perform SEM and microsectioning.

The 2 devices used for internal water vapour content may be used to repeat any of the other tests, as necessary, if their condition permits.

##### 7.1.4.1.2.1 Internal Water Vapour Content.

###### (a) **Applicability**



This test is not applicable to glass devices or to devices without a cavity.

###### (b) **Procedure**

This test shall be performed on 2 devices, in accordance with the requirements of MIL-STD-883, Method 1018, Procedure 1.

##### 7.1.4.1.2.2 Opening

6 devices shall be opened using a technique which does not contaminate the internal structure or in any way impair the ability to observe defects.

 	<p>ESA/SCC Basic Specification No. 2269010</p>		<p>PAGE 14 ISSUE 1</p>
---	--	--	----------------------------

#### 7.1.4.1.2.3 Internal Visual Inspection

Each device shall be visually inspected in accordance with ESA/SCC Basic Specification No. 20400. Photographs shall be taken as follows:-

- (a) An overall photograph of the opened device.
- (b) An overall photograph of the die.
- (c) Photographs of any anomalies found.

#### 7.1.4.1.2.4 Scanning Electron Microscope (SEM) Inspection

This test shall be performed on 1 or more devices, as necessary. This inspection shall include, but shall not necessarily be limited to, examination of the following:-

- (a) Detailed examination of any anomalies identified by the internal visual inspection (Para. 7.1.4.1.2.3 above).

Photographs shall be taken of the above.

- (b) Low magnification (up to 500X) shall be used to assess:-

- (i) Clearance of bond wires at the die edge.
- (ii) Quality of bonding at the die.
- (iii) Quality of bonding at the post.

Photographs shall be taken of the above.

- (c) High magnification (greater than 500X) shall be used to assess, when applicable:-

- (i) Mesa.
- (ii) Passivation.
- (iii) Access zone.
- (iv) Gate definition.
- (v) Metallisation coverage and consistency at steps.
- (vi) Metallisation coverage at contact windows, bonding pads, etc....

Photographs shall be taken of the above.

In the case of devices with a glassivated surface this examination shall first be attempted through the glassivation.

If the resolution is inadequate, the glassivation shall be removed. This step must be postponed until the bond strength (Para .7.1.4.1.2.5) test has been performed.

#### 7.1.4.1.2.5 Bond Strength Test

This test may be performed on the 2 devices which have been submitted the SEM analysis. The test shall be in accordance with ESA/SCC Generic Specification No. 9010, Para. 9.7.3.

#### 7.1.4.1.2.6 Die Shear Test

This test may be performed on 2 devices in accordance with the requirements of ESA/SCC Generic Specification No. 9010, Para. 9.7.4.

	<p style="text-align: center;">ESA/SCC Basic Specification No. 2269010</p>	<p style="text-align: right;">PAGE 15 ISSUE 1</p>
---	--	---

#### 7.1.4.1.2.7 Microsectioning

This test shall be performed on 1 or more devices, as necessary.

##### (a) **Glassivation Layer Integrity**

In accordance with the requirements of MIL-STD-883, Method 2021 for aluminium metalisation. For gold metalisation, the solution shall be replaced by Aqua Regia.

##### (b) **Mounting**

The devices shall be mounted in one of the following ways:-

- (i) On a carrier when ION etching is used.
- (ii) In a transparent thermosetting resin when mechanical grinding and polishing is required. The resin shall have a curing temperature below the maximum storage temperature of the device(s) and shall be evacuated after mixing and after the device has been mounted in the uncured resin.

##### (c) **Microsectioning**

In the case of mechanical grinding and polishing, the device(s) shall be ground and polished to achieve a surface finish of a high level using the method applicable to the technology involved. To improve definition and detail, chemical etches may be used to highlight junction definition, metallographic features, etc...

The following, not exhaustive features shall be assessed:

- Device structure, epitaxial interfaces (when possible).
- Passivation, dielectrics.
- Metal/semiconductors, metal/metal and metal/dielectric interfaces. Back etching of the substrate may be carried out to assess ohmic contacts and Schottky contact structures.
- Plating thickness and consistency on posts and pins.

Photographs shall be taken of the above.

#### 7.1.4.2 Group 3B - ESD Testing

ESD testing shall be performed on 5 devices in accordance with the requirements of ESA/SCC Basic Specification No. 23800. If the component under examination is not categorised into one of the 3 classes listed, then the component shall be termed "unclassified".

If it is found that 5 devices are insufficient to establish Class and Critical Path Failure Voltage, electronically good devices which remain from Subgroup 3C shall be used to continue the test.

#### 7.1.4.3 Subgroup 3C - Package Tests

##### **N.B.**

These tests shall not be carried out when delivery restricted to naked dice is foreseen.

#### 7.1.4.3.1 General

The devices in this subgroup shall be divided between Paras 7.1.4.3.2, 7.1.4.3.3 and 7.1.4.3.4 in the ratio 4:4:2. Any devices from Paras 7.1.4.3.2 or 7.1.4.3.3 that have not been destroyed shall then be subjected to Para. 7.1.4.3.4.

	<p style="text-align: center;">ESA/SCC Basic Specification No. 2269010</p>	<p>PAGE 16 ISSUE 1</p>
---	--	----------------------------

#### 7.1.4.3.2 Environmental Tests

##### (a) **Applicability**

These tests must be performed on electrically good devices.

##### (b) **Procedure**

###### (i) Thermal Shock

All devices shall be submitted to the test in accordance with ESA/SCC Generic Specification No. 9010, Para. 9.20 - 50 cycles instead of 5 cycles (100 cycles instead of 10 cycles for glass encapsulated devices).

###### (ii) Seal Tests

All devices shall be subjected to the tests in accordance with Para. 5.8 of this specification.

###### (iii) Electrical Measurements

These measurements shall be made in accordance with Table 2 of the Detail Specification.

###### (iv) Moisture Resistance

###### - Applicability

This test is not applicable to glass non-cavity devices.

###### - Procedure

In accordance with the requirements of ESA/SCC Generic Specification No. 9010, Para. 9.21.

###### (v) Seal Tests

All devices shall be subjected to the tests in accordance with Para. 5.8 of this specification.

###### (vi) Electrical Measurements

These measurements shall be made in accordance with Table 2 of the Detail Specification.

#### 7.1.4.3.3 Mechanical Tests

##### (a) **Tests that Must Be Performed on Electrically Good Devices**

###### (i) Shock

All devices shall be subjected to the test in accordance with ESA/SCC Generic Specification No. 9010, Para. 9.18 - 50 shocks instead of 5 shocks.



###### (ii) Seal Tests

All devices shall be subjected to the tests in accordance with Para. 5.8 of this specification.

###### (iii) Electrical Measurements

These measurements shall be made in accordance with Table 2 of the Detail Specification.



 	<p style="text-align: center;">ESA/SCC Basic Specification No. 2269010</p>	<p>PAGE 17 ISSUE 1</p>
---	--	----------------------------

(iv) **Vibration**

All devices shall be subjected to the test in accordance with ESA/SCC Generic Specification No. 9010, Para. 9.19 - 120 sweeps (total) instead of 12 sweeps (total).

(v) **Seal Tests**

All devices shall be subjected to the tests in accordance with Para. 5.8 of this specification.

(vi) **Electrical Measurements**

These measurements shall be made in accordance with Table 2 of the Detail Specification.

(b) **Tests That Can Be Performed On Electrical Rejects**

(i) **Solderability (if applicable)**

All devices shall be subjected to the test in accordance with ESA/SCC Generic Specification No. 9010, Para. 9.22.

(ii) **Permanence of Marking**

All devices shall be subjected to the test in accordance with ESA/SCC Generic Specification No. 9010, Para. 9.23.

7.1.4.3.4 **Resistance to Soldering Heat**

(a) **Applicability**

This test must be performed on electrically good devices.

(b) **Procedure**

In accordance with the requirements of IEC Publication No. 68-2-20, Test 'Tb', Method 1A with no thermal screen or flux for  $10 \pm 1s$  or MIL-STD-750, Method 2031. Following each cycle, electrical measurements shall be performed in accordance with Table 2 of the Detail Specification (go-no-go) and a hermeticity test shall be performed in accordance with Para. 5.8 of this specification. The test shall be repeated until the device has failed or 5 cycles have been performed, whichever is the sooner.

7.2 EVALUATION TEST PROGRAMME FOR CAPABILITY APPROVAL (CHART IB)

Where specified, intermediate and final measurements shall be performed in accordance with Para. 7.1.3.2.3 of this specification.

7.2.1 Group 1 - TCV Test Programme (Chart IB1)

TCVs should be bonded into dual-in-line packages in order to simplify tests and measurements. No RF measurements are required on these test vehicles. TCVs shall undergo the following tests.



7.2.1.1 **Subgroup 1A - Thermal Characterisation**

3 TCVs shall undergo a thermal characterisation.

High and low temperature characterisation shall be carried out on the main parameters of each discrete cell of the TCV. This activity can be carried out on-wafer. This activity shall be performed to provide information to Designers on thermal behaviour of the technology and to provide the information for Table 3 of the Detail Specifications.

7.2.1.2 **Subgroup 1B - Temperature Storage Testing**

2 x 12 TCVs shall undergo storage tests at two different temperatures ( $+250^{\circ}C < T_{amb} < +285^{\circ}C$ ). These tests shall be performed up to 1000 hours or until 50% of defectives have been produced. Final measurements shall be performed.

		<p style="text-align: center;">ESA/SCC Basic Specification No. 2269010</p>		<p>PAGE 18 ISSUE 1</p>
---	---	--	--	----------------------------

#### 7.2.1.3 Subgroup 1C - Endurance Testing

5 x 12 TCVs shall undergo endurance tests at a minimum of three different temperatures ( $+175^{\circ}\text{C} < T_{\text{amb}} < +225^{\circ}\text{C}$ ) and under a minimum of three different biases (5 tests). These tests shall be performed for up to 4000 hours or until 50% of defectives have been produced. Intermediate and final measurements shall be performed. As an example, the following conditions could be applicable:

- Test 1,  $T_j = +175^{\circ}\text{C}$ , bias condition 1.
- Test 2,  $T_j = +200^{\circ}\text{C}$ , bias condition 1.
- Test 3,  $T_j = +225^{\circ}\text{C}$ , bias condition 1.
- Test 4,  $T_j = +225^{\circ}\text{C}$ , bias condition 2.
- Test 5,  $T_j = +225^{\circ}\text{C}$ , bias condition 3.

Bias condition 1 may be the most representative biasing for normal operation.

Bias condition 2 may be the most stringent biasing in order to investigate the effect of high electrical fields.

Bias condition 3 may be the most stringent biasing in order to investigate the effect of high current density.

#### 7.2.1.4 Subgroup 1D - Packaging Atmosphere Testing

4 x 8 TCVs shall undergo packaging atmosphere testing under a minimum of 4 different assembly conditions (e.g.  $\text{N}_2 + \text{AuSn}$ ,  $\text{N}_2 + \text{Epoxy}$ ,  $\text{N}_2/\text{H}_2 + \text{AuSn}$ ,  $\text{N}_2/\text{O}_2 + \text{AuSn}$ ). They shall be submitted for up to 2000 hours life testing for each different assembly method. Final measurements shall be performed. Residual Gas Analysis shall be carried out by the end of the tests on a minimum of 2 samples from each test file.

#### 7.2.1.5 Subgroup 1E - Radiation Analysis

5 TCVs shall be submitted to radiation testing as specified in Para. 7.1.4.1.1.

#### 7.2.1.6 Subgroup 1F - ESD Testing

5 TCVs shall be submitted to ESD testing as specified in Para. 7.1.4.2.

### 7.2.2 Group 2 - DEC Test Programme (Chart IB2)

DECs shall be bonded into packages defined in the P.I.D. and shall undergo the following tests.

#### 7.2.2.1 Subgroup 2A - Thermal Characterisation

3 DECs shall undergo a thermal characterisation as specified in Para. 7.2.1.1 of this specification.

#### 7.2.2.2 Subgroup 2B - Endurance Testing

3 x 16 DECs shall undergo endurance tests, at two different junction temperatures ( $+175^{\circ}\text{C} < T_{\text{amb}} < +225^{\circ}\text{C}$ ) and under two different biases (3 tests). These tests shall be performed for up to 4000 hours or until 50% of defectives have been produced. Intermediate and final measurements shall be performed. DEC life tests shall be carried out under nominal bias condition and at one of the other conditions as specified for the basic FET on the TCV. As an example, the following conditions could be applicable:

	<p style="text-align: center;">ESA/SCC Basic Specification No. 2269010</p>	<p>PAGE 19 ISSUE 1</p>
---	--	----------------------------

- Test 1,  $T_j = +175^\circ\text{C}$ , bias condition 1.
- Test 2,  $T_j = +225^\circ\text{C}$ , bias condition 1.
- Test 3,  $T_j = +225^\circ\text{C}$ , bias condition 2.

Bias condition 1 may be the most representative biasing for normal operation.

Bias condition 2 may be the most stringent biasing in order to investigate the effect of high electrical fields or high current density to access the limit of the application domain.

#### 7.2.2.3 Subgroup 2C - Radiation Analysis

5 DEC's shall be submitted to radiation testing as specified in Para. 7.1.4.1.1.

#### 7.2.2.4 Subgroup 2D - ESD Testing

5 DEC's shall be submitted to ESD testing as specified in Para. 7.1.4.2.

#### 7.2.2.5 Subgroup 2E - RF Compression

For power MMIC technology, or if the capability domain allows operation under compression, 8 DEC's shall be submitted to step-stress testing starting at 1dB compression at ambient temperature, ( $T_j < +80^\circ\text{C}$ ). The compression shall be increased by 1dB steps every 168 hours until 8dB compression is successfully achieved or the DEC's fail.

### 7.2.3 Group 3 - RIC Test Programme (Chart IB3)

RICs shall be bonded into packages defined in the P.I.D. or using microwave modules.

#### 7.2.3.1 Subgroup 3A - Endurance Testing

3 x 16 RICs shall undergo endurance tests, at two different junction temperatures ( $+175^\circ\text{C} < T_{amb} < +225^\circ\text{C}$ ) and under two different biases (3 tests). These tests shall be carried out for up to 4000 hours or until 50% of defectives have been produced. Intermediate and final measurements shall be performed. As an example, the following conditions could be applicable:

- Test 1,  $T_j = +175^\circ\text{C}$ , bias condition 1.
- Test 2,  $T_j = +225^\circ\text{C}$ , bias condition 1.
- Test 3,  $T_j = +225^\circ\text{C}$ , bias condition 2.

Bias condition 1 may be the most representative biasing for normal operation.

Bias condition 2 may be the most stringent biasing in order to investigate the effect of high electrical fields or high current density to access the limits of the design.

On completion of endurance testing, destructive physical analysis (DPA) shall be performed on 2 RICs selected at random from the devices above.

#### 7.2.3.2 Subgroup 3B - Constructional Analysis

A minimum of 6 RICs shall be submitted to constructional analysis, as specified in Para. 7.1.4.1.2 of this specification except that the Internal Water Vapour Content test specified in Para. 7.1.4.1.2.1 shall not be performed.

	<p style="text-align: center;">ESA/SCC Basic Specification No. 2269010</p>		<p>PAGE 20 ISSUE 1</p>
---	--	--	----------------------------

7.2.3.3 Subgroup 3C - Package Testing

**N.B.**

These tests shall not be carried out when delivery restricted to naked dice is foreseen.

7.2.3.3.1 General

10 RICs shall be divided between Paras 7.2.3.3.2 and 7.2.3.3.3 in the ratio 5:5.

7.2.3.3.2 Environmental Tests

(a) **Temperature Cycling**

All devices shall be subjected to the test in accordance with ESA/SCC Generic Specification No. 9010 Para. 9.10 - 100 cycles instead of 10 cycles.

(b) **Thermal Shock**

All devices shall be subjected to the test in accordance with ESA/SCC Generic Specification No. 9010 Para. 9.20 - 100 cycles instead of 10 cycles.

(c) **Seal Tests**

All devices shall be subjected to the tests in accordance with Para. 5.8 of this specification.

(d) **Electrical Measurements**

These measurements shall be made in accordance with Table 2 of the Test Document.

7.2.3.3.3 Mechanical Tests

(a) **Shock Test**

All devices shall be subjected to the test in accordance with ESA/SCC Generic Specification No. 9010, Para. 9.18, 50 pulses (per orientation) instead of 5 pulses (per orientation).

(b) **Vibration**

All devices shall be subjected to the test in accordance with ESA/SCC Generic Specification No. 9010, Para. 9.19, 120 sweeps (total) instead of 12 sweeps (total).

(c) **Constant Acceleration**

All devices shall be subjected to the test in accordance with ESA/SCC Generic Specification No. 9010, Para. 9.11.

(d) **External Visual Inspection**



In accordance with ESA/SCC Basic Specification No. 20500.

(e) **Seal Tests**

All devices shall be subjected to the tests in accordance with Para. 5.8 of this specification.

(f) **Electrical Measurements**

These measurements shall be made in accordance with Table 2 of the Test Document.

 	ESA/SCC Basic Specification No. 2269010		PAGE 21 ISSUE 1
---	--	--	--------------------

(g) **Residual Gas Analysis**



MIL-STD-883, Method 1018, Procedure 1.

7.3 EVALUATION RESULTS

On completion of each evaluation test programme the Manufacturer shall assemble all relevant test data and documentation in the form of a test report. This report shall be sent to the Qualifying Space Agency for review and approval.

For capability approval, the final definition of the capability domain, its boundaries, and the capability abstract shall be submitted for approval to the QSA.

The Manufacturer shall also submit the draft P.I.D. and any draft Detail Specifications to the QSA for final review and approval.

 	ESA/SCC Basic Specification No. 2269010		PAGE 22 ISSUE 1
---	--	--	--------------------

## 8. DATA DOCUMENTATION

### 8.1 GENERAL REQUIREMENTS

The general requirements for data documentation are specified in Para. 8.1.1 for qualification testing and Para. 8.1.2 for capability approval. Evaluation reports shall be prepared based on these requirements as expanded by the subsequent paragraphs.

#### 8.1.1 Qualification Testing

An evaluation test report shall be established to include the following:-

- (a) Cover sheet (or sheets).
- (b) List of equipment (testing and measuring).
- (c) List of test references.
- (d) Sample identification.
- (e) Production data.
- (f) Inspection data.
- (g) Initial electrical measurements.
- (h) Group 1 - Control group data.
- (i) Thermal impedance data.
- (j) Subgroup 2A(i) - Electrical endurance test, temperature 1, bias 1.
- (k) Subgroup 2A(ii) - Electrical endurance test, temperature 2, bias 1.
- (l) Subgroup 2A(iii) - Electrical endurance test, temperature 2, bias 2.
- (m) Subgroup 2B(i) - Temperature storage test, temperature 1.
- (n) Subgroup 2B(ii) - Temperature storage test, temperature 2.
- (o) Subgroup 3A(i) - Radiation tests data.
- (p) Subgroup 3A(ii) - Constructional analysis data.
- (q) Subgroup 3B - ESD test data.
- (r) Subgroup 3C - Package test data.
- (s) Summary of results and conclusions.

All items listed shall be grouped, preferably as subpackages, and for identification purposes, each page shall include the following information:

- Manufacturer's/test house's name.
- Lot identification.
- Date of establishment of the document.
- Page number.

#### 8.1.2 Capability Approval

An evaluation test report shall be established to include the following:-

- (a) Cover sheet (or sheets).
- (b) List of equipment (testing and measuring).
- (c) List of test references.
- (d) Sample identification.
- (e) Production data.
- (f) Inspection data.
- (g) Initial electrical measurements.



The following items should be established as separate sections of the test report:-

- (h) Subgroup 1A - Thermal characterisation.
- (i) Subgroup 1B(i) - Temperature storage test, temperature 1.
- (j) Subgroup 1B(ii) - Temperature storage test, temperature 2.
- (k) Subgroup 1C(i) - Electrical endurance test, temperature 1, bias 1.
- (l) Subgroup 1C(ii) - Electrical endurance test, temperature 2, bias 1.
- (m) Subgroup 1C(iii) - Electrical endurance test, temperature 3, bias 1.
- (n) Subgroup 1C(iv) - Electrical endurance test, temperature 3, bias 2.
- (o) Subgroup 1C(v) - Electrical endurance test, temperature 3, bias 3.
- (p) Subgroup 1D(i) - Packaging atmosphere test data 1.
- (q) Subgroup 1D(ii) - Packaging atmosphere test data 2.
- (r) Subgroup 1D(iii) - Packaging atmosphere test data 3.
- (s) Subgroup 1D(iv) - Packaging atmosphere test data 4.
- (t) Subgroup 1E - Radiation test data.
- (u) Subgroup 1F - ESD test data.
- (v) Summary of results and conclusions.
  
- (h) Subgroup 2A - Thermal characterisation.
- (i) Subgroup 2B(i) - Electrical endurance test, temperature 1, bias 1.
- (j) Subgroup 2B(ii) - Electrical endurance test, temperature 2, bias 1.
- (k) Subgroup 2B(iii) - Electrical endurance test, temperature 2, bias 2.
- (l) Subgroup 2C - Radiation tests data.
- (m) Subgroup 2D - ESD test data.
- (n) Subgroup 2E - RF compression tests data.
- (o) Summary of results and conclusions.
  
- (h) Subgroup 3A(i) - Electrical endurance test, temperature 1, bias 1.
- (i) Subgroup 3A(ii) - Electrical endurance test, temperature 2, bias 1.
- (j) Subgroup 3A(iii) - Electrical endurance test, temperature 2, bias 2.
- (k) Subgroup 3B - Constructional analysis data.
- (l) Subgroup 3C - Package test data.
- (m) Summary of results and conclusions.

All items listed shall be grouped, preferably as subpackages, and for identification purposes, each page shall include the following information:

- Manufacturer's/test house's name.
- Lot identification.
- Date of establishment of the document.
- Page number.

	ESA/SCC Basic Specification No. 2269010		PAGE 24 ISSUE 1
---	--	--	--------------------

## 8.2 COVER SHEET(S)

The cover sheet (or sheets) of the evaluation test report shall include as a minimum:-

- (a) Reference to this document, including issue and date.
- (b) Component type and number.
- (c) Lot identification.
- (d) Manufacturer's/test house's name and address.
- (e) Location of the Manufacturing plant/test house.
- (f) Signature on behalf of the Manufacturer/test house.
- (g) Total number of pages of the evaluation test report.

## 8.3 LIST OF EQUIPMENT USED

A list of equipment used for tests and measurements shall be included in the evaluation test report. Where applicable, this list shall contain the inventory number, Manufacturer's type number, serial number, calibration status data, etc. This list shall indicate for which tests such equipment was used.

## 8.4 LIST OF TEST REFERENCES

This list shall include all references or codes which are necessary to correlate the test data provided with the applicable tests.

## 8.5 SAMPLE SELECTION (PARA 4.1)

This shall identify the criteria used for the selection of the particular components used for the tests, when evaluating a range of components by means of representative samples.

## 8.6 MANUFACTURING DATA (PARA 4.6)

The progress of the components through the normal manufacturing processes shall be documented. The components failing a particular process shall be detailed, together with the reason for their removal.

## 8.7 INSPECTION DATA (PARA.5)

The number of components subjected to each test shall be identified together with the number and reason for any rejects. Radiographs of any failed components shall be presented.

## 8.8 INITIAL MEASUREMENTS DATA (PARA. 6)

### 8.8.1 Initial Electrical Measurements Data (Para. 6.1)

All data shall be recorded against serial numbers. A histogram of the device parameters shall be produced.



### 8.8.2 Thermal Analysis Data

All data shall be recorded against serial numbers. "Hot spot" pictures shall be delivered for power devices.

### 8.8.3 Specific Dynamic Measurements Data

All data shall be recorded against serial numbers.



 	ESA/SCC Basic Specification No. 2269010		PAGE 25 ISSUE 1
---	--	--	--------------------

#### 8.8.4 Design System Assessment

All data shall be recorded against serial numbers.

### 8.9 EVALUATION DATA

#### 8.9.1 Qualification Testing

##### 8.9.1.1 Group 1 - Control Group Data (Para. 7.1.2)

All data shall be recorded against serial numbers.

##### 8.9.1.2 Group 2 - Ageing Tests

##### 8.9.1.2.1 Subgroups 2A (i),(ii),(iii) - Accelerated Electrical Endurance Tests Data (Para. 7.1.3.2).

All data shall be recorded against serial numbers. This shall include:-

- (a) Temperatures T1 and T2.
- (b) Initial, intermediate and final electrical measurements, plotted for each intermediate time.
- (c) Dispersion and drift values referred to the initial electrical measurements (Para. 6.1).
- (d) Analysis of any failed components as defined in Para. 7.1.3.2.4.

##### 8.9.1.2.2 Subgroups 2B (i),(ii) - Temperature Storage Tests (Para. 7.1.3.3)

All data shall be recorded against serial numbers. This shall include:-

- (a) Temperatures T1 and T2.
- (b) Initial, intermediate and final electrical measurements, plotted for each intermediate time.
- (c) Dispersion and drift values referred to the initial electrical measurements (Para. 6.1).
- (d) Analysis of any failed components as defined in Para. 7.1.3.2.4.

##### 8.9.1.3 Group 3 - Destructive Tests

##### 8.9.1.3.1 Subgroup 3A - Radiation Analysis Data (Para. 7.1.4.1.1)

All data shall be recorded against serial numbers. This shall include:-

- (a) Total dose steady-state test data.
- (b) Conditions and equipment.

##### 8.9.1.3.2 Subgroup 3A - Constructional Analysis Data (Para. 7.1.4.1.2)

All data shall be recorded against serial numbers. This shall include:-

- (a) Internal water vapour content data.
- (b) Photographs.
- (c) SEM photographs.
- (d) Results of bond strength test.
- (e) Results of die shear test.
- (f) Glassivation layer integrity test data (if applicable).
- (g) Microsectioning photographs.

	<p style="text-align: center;">ESA/SCC Basic Specification No. 2269010</p>		<p>PAGE 26 ISSUE 1</p>
---	--	--	----------------------------

8.9.1.3.3 Subgroup 3B - ESD Test Data (Para. 7.1.4.2)

All data shall be recorded against serial numbers. This shall include:-

- (a) Conditions and equipment.
- (b) Results of ESD tests.

8.9.1.3.4 Subgroup 3C - Package Tests Data (Para. 7.1.4.3)

All data shall be recorded against serial numbers. This shall include:-

- (a) Fine leak test data.
- (b) Gross leak test data.

8.9.2 Capability Approval

8.9.2.1 Group 1 - TCV Test Programme Data.

8.9.2.1.1 Subgroup 1A - Thermal Characterisation Test Data (Para. 7.2.1.1)

8.9.2.1.2 Subgroup 1B(i), (iii) - Temperature Storage Tests Data (Para. 7.2.1.2)

All data shall be recorded against serial numbers. This shall include:-

- (a) Temperatures T1 and T2.
- (b) Initial and final electrical measurements.
- (c) Analysis of any failed test structures as defined in Para. 7.1.3.2.4.

8.9.2.1.3 Subgroups 1C(i), (ii), (iii), (iv), (v) - Electrical Endurance Tests Data (Para. 7.2.1.3)

All data shall be recorded against serial numbers. This shall include:-

- (a) Temperatures T1, T2 and T3.
- (b) Biases 1, 2 and 3.
- (c) Initial, intermediate and final electrical measurements.
- (d) Analysis of any failed test structures as defined in Para. 7.1.3.2.4.

8.9.2.1.4 Subgroups 1D(i), (ii), (iii), (iv) - Packaging Atmosphere Tests Data (Para. 7.2.1.4)

All data shall be recorded against serial numbers. This shall include:-

- (a) Atmospheres 1, 2, 3 and 4.
- (b) Initial and final electrical measurements.
- (c) Analysis of any failed test structures as defined in Para. 7.1.3.2.4.
- (d) Residual Gas Analysis data.

8.9.2.1.5 Subgroup 1E - Radiation Analysis Data (Para. 7.2.1.5)

All data shall be recorded against serial numbers. This shall include:-

- (a) Total dose steady-state test data.
- (b) Conditions and equipment.

**8.9.2.1.6 Subgroup 1F - ESD Test Data (Para. 7.2.1.6)**

All data shall be recorded against serial numbers. This shall include:-

- (a) Conditions and equipment.
- (b) Results of ESD tests.

**8.9.2.2 Group 2 - DEC Test Programme Data****8.9.2.2.1 Subgroup 2A - Thermal Characterisation Test Data (Para. 7.2.2.1)****8.9.2.2.2 Subgroup 2B(i), (ii), (iii) - Electrical Endurance Test Data (Para. 7.2.2.2)**

All data shall be recorded against serial numbers. This shall include:-

- (a) Temperatures T1 and T2.
- (b) Biases 1 and 2.
- (c) Initial, intermediate and final electrical measurements, plotted for each intermediate time.
- (d) Dispersion and drift values referred to the initial electrical measurements (Para. 6.1).
- (e) Analysis of any failed test structure as defined in Para. 7.1.3.2.4.

**8.9.2.2.3 Subgroup 2C - Radiation Analysis Data (Para. 7.2.2.3)**

All data shall be recorded against serial numbers. This shall include:-

- (a) Total dose steady-state test data.
- (b) Conditions and equipment.

**8.9.2.2.4 Subgroup 2D - ESD Test Data (Para. 7.2.1.6)**

All data shall be recorded against serial numbers. This shall include:-

- (a) Conditions and equipment.
- (b) Results of ESD tests.

**8.9.2.2.5 Subgroup 2E - RF Compression Tests (Para. 7.2.4.5)**



All data shall be recorded against serial numbers. This shall include:-

- (a) Initial and final electrical measurements.
- (b) Analysis of any failed test structure as defined in Para. 7.1.3.2.4.

**8.9.2.3 Group 3 - RIC Test Programme Data****8.9.2.3.1 Subgroup 3A(i), (ii), (iii) - Electrical Endurance Test Data (Para. 7.2.3.1)**

All data shall be recorded against serial numbers. This shall include:-

- (a) Temperatures T1 and T2.
- (b) Biases 1 and 2.
- (c) Initial, intermediate and final electrical measurements, plotted for each intermediate time.
- (d) Dispersion and drift values referred to the initial electrical measurements (Para. 6.1).
- (e) Analysis of any failed test structure as defined in Para. 7.1.3.2.4.
- (f) Destructive Physical Analysis (DPA) report.

 	ESA/SCC Basic Specification No. 2269010		PAGE 28 ISSUE 1
---	--	--	--------------------

8.9.2.3.2 Subgroup 3B - Constructional Analysis Data (Para. 7.2.3.2)

All data shall be recorded against serial numbers. This shall include:-

- (a) Photographs.
- (b) SEM photographs.
- (c) Results of bond strength test.
- (d) Results of die shear test.
- (e) Glassification layer integrity test data (if applicable).
- (f) Microsectioning photographs.

8.9.2.3.3 Subgroup 3C - Package Test Data

8.9.2.3.3.1 Subgroup 3C(i) - Environmental Tests Data (Para. 7.2.3.3.2)

All data shall be recorded against serial numbers. This shall include:-

- (a) Fine leak test data.
- (b) Gross leak test data.
- (c) Initial and final electrical measurements.
- (d) Analysis of any failed test structure as defined in Para. 7.1.3.2.4.

8.9.2.3.3.2 Subgroup 3C(ii) - Mechanical Tests Data (Para. 7.2.3.3.3)

All data shall be recorded against serial numbers. This shall include:-

- (a) External visual inspection failure modes.
- (b) Fine leak test data.
- (c) Gross leak test data.
- (d) Initial and final electrical measurements.
- (e) Analysis of any failed test structures as defined in Para. 7.1.3.2.4.
- (f) Residual Gas Analysis data.

8.10 SUMMARY OF RESULTS AND CONCLUSIONS

The above shall be briefly reviewed, indicating the success or otherwise of the evaluation test programme. Any production screens that need to be introduced into the P.I.D. shall be outlined.



**CHART IA - EVALUATION TEST PROGRAMME FOR QUALIFICATION TESTING**

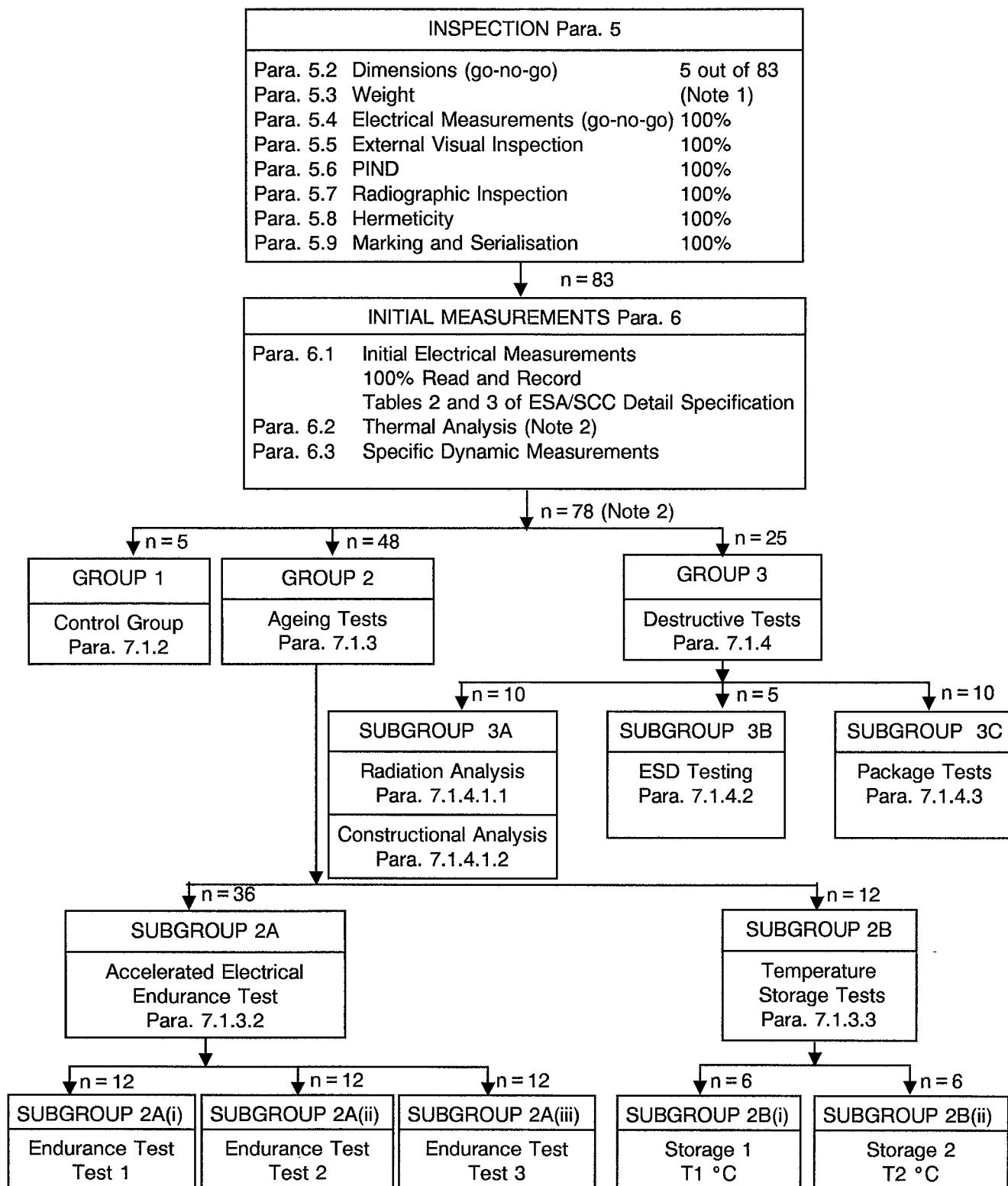

**NOTES**

1. For detailed requirements, see Para. 5.3.
2. 5 devices out of the initial 83 devices could be destroyed in thermal analysis.



**SCC**

ESA/SCC Basic Specification

No. 2269010

PAGE 30

ISSUE 1

**CHART IB - EVALUATION TEST PROGRAMME FOR CAPABILITY APPROVAL**

**CHART IB1 - GROUP 1 TCV EVALUATION**

INSPECTION Para. 5		
Para. 5.4 Electrical Measurements (go-no-go)	100%	
Para. 5.8 Hermeticity	100%	
Para. 5.9 Serialisation and Traceability	100%	

n = 134

INITIAL MEASUREMENTS Para. 6	
Para. 6.1 Initial Electrical Measurements 100% Read and Record Tables 2 and 3 of Test Document	
Para. 6.2 Thermal Analysis (Note 1)	
Para. 6.3 Specific Dynamic Measurements (Note 2)	
Para. 6.4 Design System Assessment	

n = 129

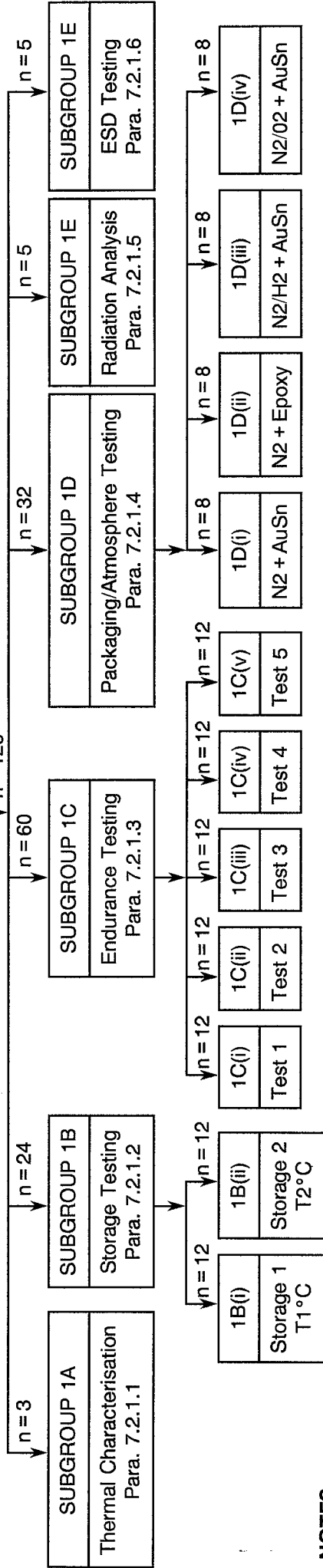

**NOTES**

- 5 devices out of the initial 134 devices could be destroyed in thermal analysis.
- To be performed on either TCVs or DECs.



**CHART IB - EVALUATION TEST PROGRAMME FOR CAPABILITY APPROVAL (CONT'D)**

**CHART IB2 - GROUP 2 DEC EVALUATION**

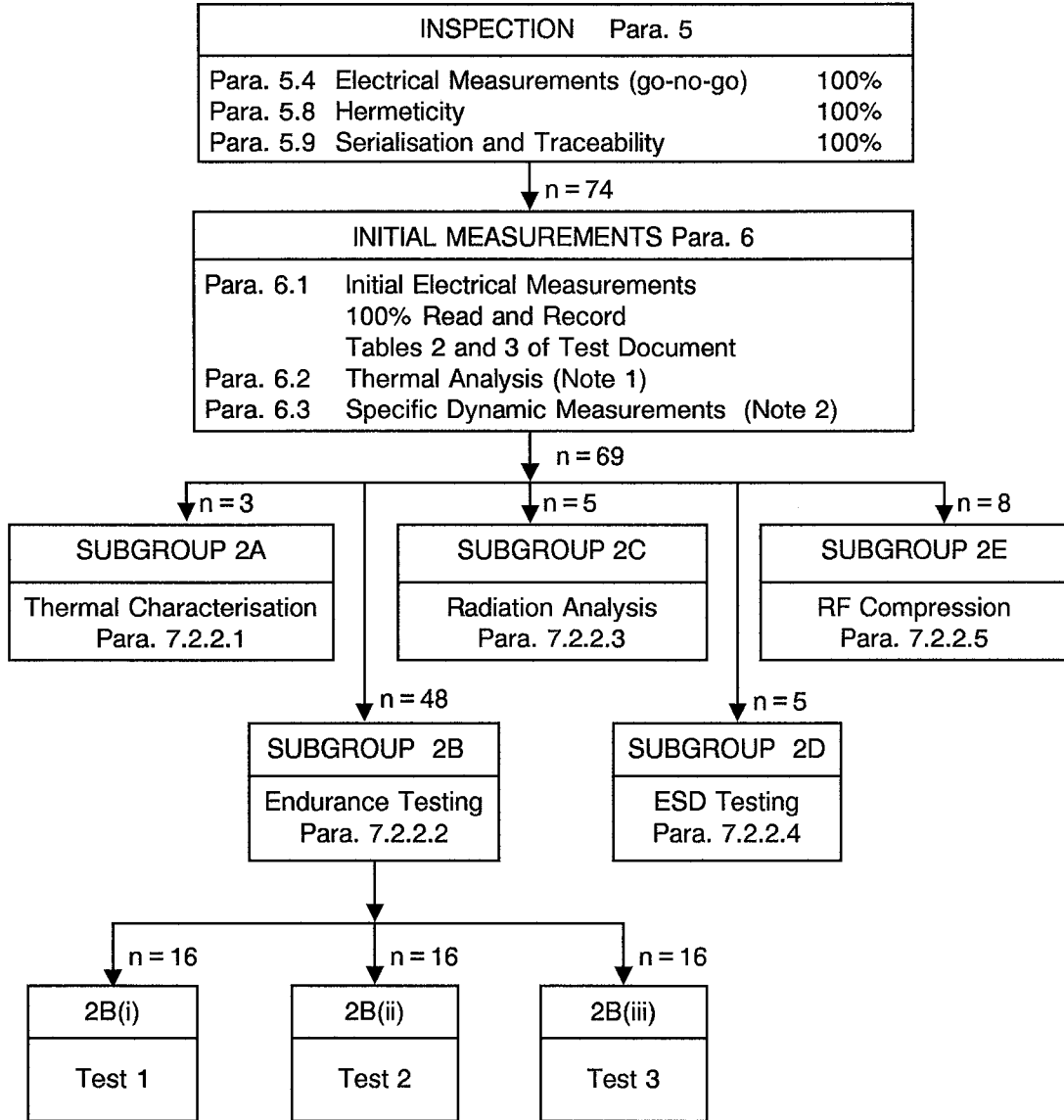

**NOTES**

1. 5 devices out of the initial 74 devices could be destroyed in thermal analysis.
2. To be performed on either TCVs or DECs.

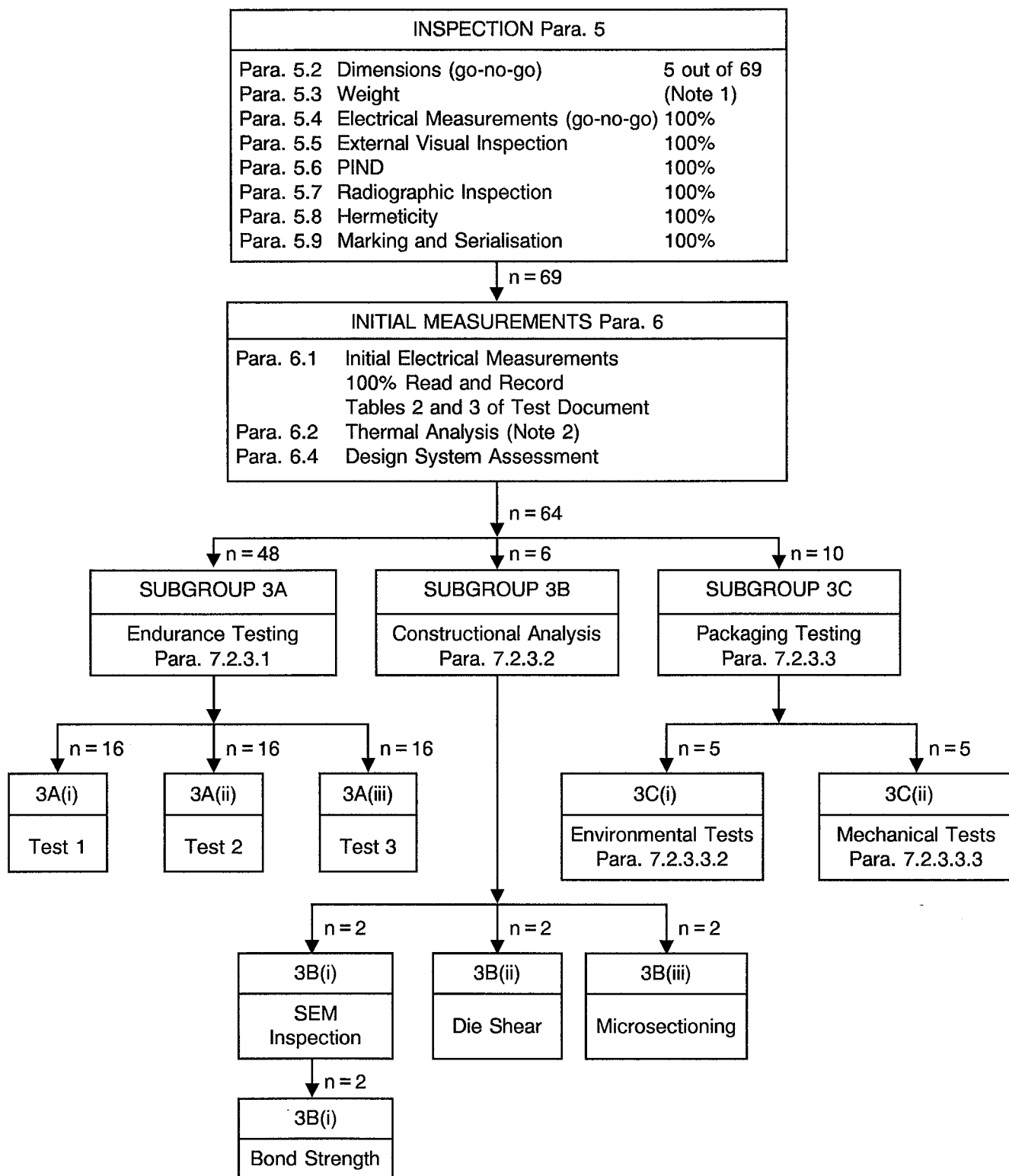
**CHART IB - EVALUATION TEST PROGRAMME FOR CAPABILITY APPROVAL (CONT'D)**
**CHART IB3 - GROUP 3 RIC EVALUATION**

**NOTES**

1. For detailed requirements, see Para. 5.3.
2. 5 devices out of the initial 69 devices could be destroyed in thermal analysis.





SCC

ESA/SCC Basic Specification  
No. 2269010

PAGE 33  
ISSUE 1

**CHART II - ACCELERATED ELECTRICAL ENDURANCE TEST**

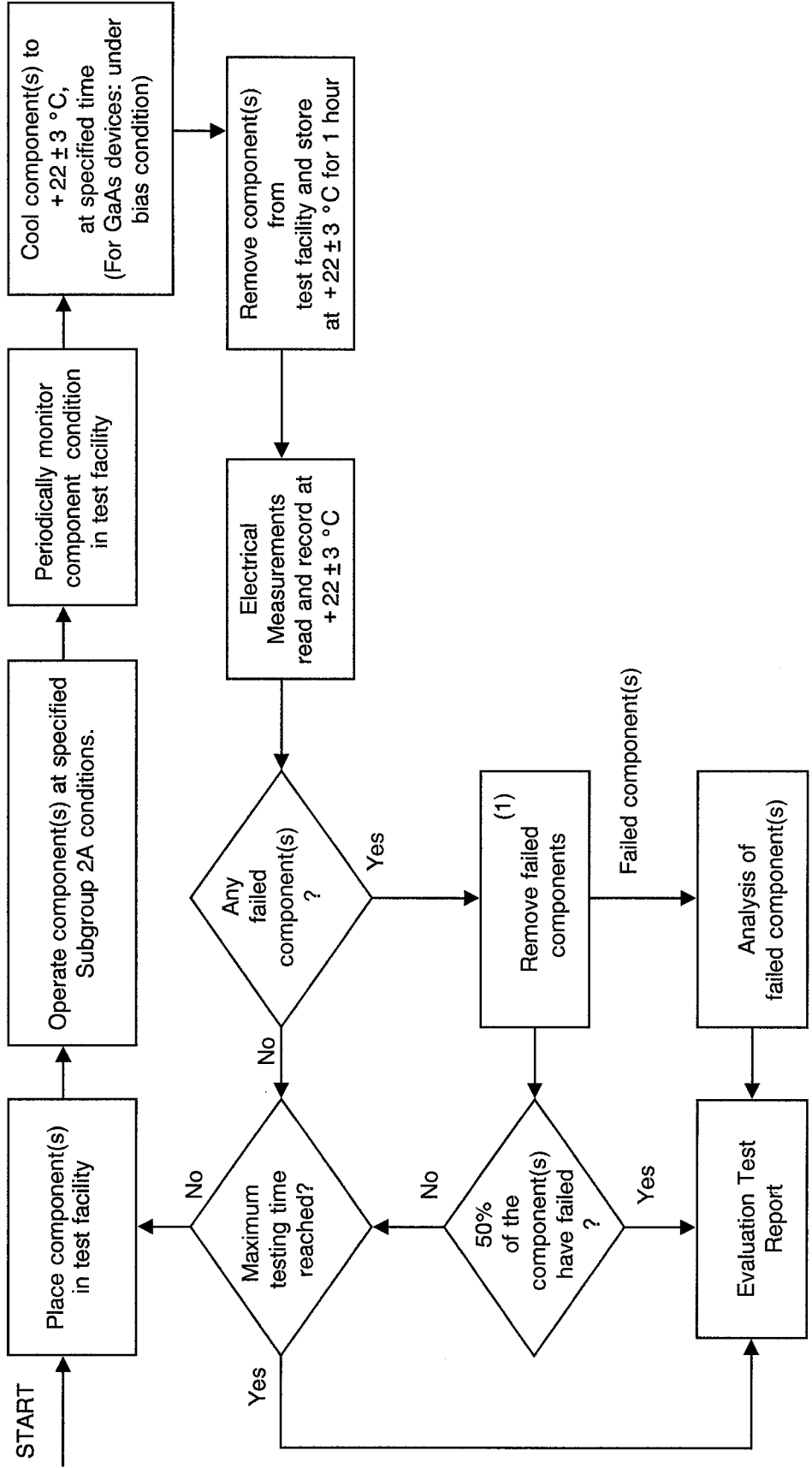

**NOTES**

1. Before removal, see Para. 7.1.3.2.4.



SCC

CHART III - TEMPERATURE STORAGE TESTS

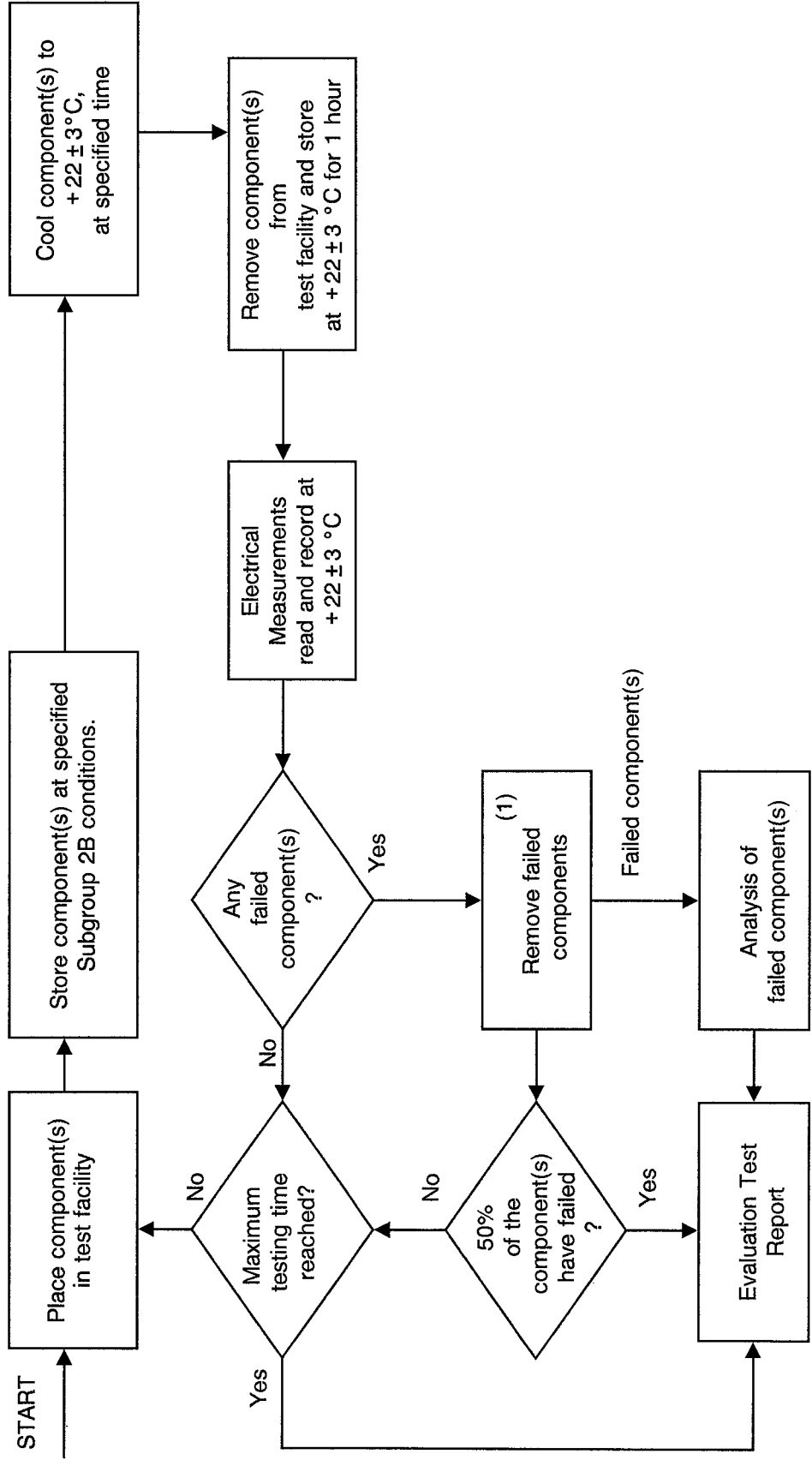

**NOTES**

1. Before removal, see Para. 7.1.3.2.4.