



**european space agency
agence spatiale européenne**

Pages 1 to 42

CHARGE COUPLED DEVICES, SILICON,

PHOTOSENSITIVE

ESA/SCC Generic Specification No. 9020



**space components
coordination group**

Issue/Rev.	Date	Approved by	
		SCCG Chairman	ESA Director General or his Deputy
Issue 2	April 1999		
Revision 'A'	December 2000		



DOCUMENTATION CHANGE NOTICE

Rev. Letter	Rev. Date	Reference	CHANGE Item	Approved DCR No.
		<p>This Issue supersedes Issue 1 and incorporates all modifications defined in Revisions 'A', 'B' and 'C' to Issue 1 and the changes agreed in the following DCRs:-</p> <p>Cover page DCN Para. 8.2.1 : New penultimate paragraph added : New second sentence added to last paragraph Chart V : "(5)" added to "No failures allowed" : Note 5 added Para. 10.1.2.1 : Item (b), "PDA figure and" deleted from text : Item (c) rewritten Para. 10.1.3.1 : Item (a), "(including PDA figure)" deleted Para. 10.10 : New Item (e) added</p>	<p>None None 21134 21111 21134 21134 21119 21119 21119 21134</p>	
'A'	Dec. '00	<p>P1. Cover page P2. DCN P33. Para. 9.17 : Additional text added</p>	<p>None None 221584</p>	



TABLE OF CONTENTS

	<u>Page</u>
1. <u>INTRODUCTION</u>	6
1.1 Scope	6
1.2 Applicability	6
2. <u>APPLICABLE DOCUMENTS</u>	6
2.1 ESA/SCC Specifications	6
2.2 Other (Reference) Documents	7
2.3 Order of Precedence	7
3. <u>TERMS, DEFINITIONS, ABBREVIATIONS, SYMBOLS AND UNITS</u>	7
4. <u>REQUIREMENTS</u>	7
4.1 General	7
4.1.1 Specifications	7
4.1.2 Conditions and Methods of Test	7
4.1.3 Manufacturer's Responsibility for Performance of Tests and Inspections	8
4.1.4 Inspection Rights	8
4.1.5 Pre-encapsulation or Post-encapsulation Inspection	8
4.2 Qualification Approval Requirements on a Manufacturer	8
4.3 Deliverable Components	8
4.3.1 Lot Failure	8
4.3.2 Testing and Lot Acceptance Levels	9
4.4 Marking	9
4.5 Materials and Finishes	9
5. <u>PRODUCTION CONTROL FOR QUALIFICATION</u>	10
5.1 General	10
5.2 Special In-process Controls	10
5.2.1 Scanning Electron Microscope Inspection	10
5.2.2 Total Dose Irradiation Testing	10
5.2.3 Rebonding	10
5.2.4 Documentation	10
6. <u>FINAL PRODUCTION TESTS</u>	12
6.1 General	12
6.2 Test Methods and Conditions	12
6.3 Documentation	12
7. <u>BURN-IN AND ELECTRICAL MEASUREMENTS</u>	12
7.1 General	12
7.1.1 Conditions of Test	12
7.1.2 Data Points	12
7.2 Failure Criteria	13
7.2.1 Parameter Drift Failure	13
7.2.2 Parameter Limit Failure	13
7.2.3 Other Failures	13
7.3 Failed Components	13
7.4 Lot Failure	13
7.4.1 Lot Failure during 100% Testing	13
7.4.2 Lot Failure during Sample Testing	13
7.5 Documentation	14



	<u>Page</u>
8. <u>QUALIFICATION APPROVAL AND LOT ACCEPTANCE TESTS</u>	14
8.1 Qualification Testing	14
8.1.1 General	14
8.1.2 Distribution within the Qualification Test Lot	14
8.2 Lot Acceptance Testing	15
8.2.1 General	15
8.2.2 Distribution within the Sample for Lot Acceptance Testing	16
8.2.3 Lot Acceptance Level 3 Testing	17
8.2.4 Lot Acceptance Level 2 Testing	17
8.2.5 Lot Acceptance Level 1 Testing	17
8.3 Failure Criteria	18
8.3.1 Environmental and Mechanical Test Failures	18
8.3.2 Electrical Failures	18
8.3.3 Other Failures	18
8.4 Failed Components	18
8.5 Lot Failure	18
8.6 Documentation	18
9. <u>TEST METHODS AND PROCEDURES</u>	23
9.1 Internal Visual Inspection	23
9.1.1 Pre-encapsulation Inspection	23
9.1.2 Post-encapsulation Inspection	23
9.2 Bond Strength and Die-Shear Tests	23
9.2.1 Bond Strength Test during Final Production Tests	23
9.2.2 Die-Shear Test during Final Production Tests	24
9.2.3 Bond Strength Test during Qualification Testing	24
9.2.4 Die-Shear Test during Qualification Testing	24
9.3 Encapsulation	24
9.4 High Temperature Stabilisation Bake	24
9.5 Temperature Cycling	24
9.6 Constant Acceleration	24
9.7 Mobile Particle Detection	24
9.8 Seal Test	25
9.8.1 Seal Test, Fine Leak	25
9.8.2 Seal Test, Gross Leak	25
9.9 Electrical Measurements	25
9.9.1 Parameter Drift Value Measurements	25
9.9.2 Electrical and Electro-Optical Measurements at High and Low Temperatures	25
9.9.3 Electrical and Electro-Optical Measurements at Reference Temperature	25
9.9.4 Parameter Measurements during Environmental, Mechanical and Endurance Testing	25
9.10 External Visual Inspection	25
9.11 Dimension Check	25
9.12 Geometrical Measurements	25
9.12.1 Mechanical and Optical References	26
9.12.2 Flatness of Image Area	26
9.12.3 Position of First Pixel	29
9.12.4 Image Plane Orientation	30
9.12.5 Distance Between Image Plane and Window	31
9.12.6 Parallelism Between Image Plane and Window	32
9.12.7 Image Plane Dimensions	32



	<u>Page</u>
9.13 Shock Test	33
9.14 Vibration	33
9.15 Electro-optical Measurements	33
9.16 Moisture Resistance	33
9.17 Solderability	33
9.18 Permanence of Marking	33
9.19 Terminal Strength	33
9.20 Operating Life	33
9.20.1 Operating Life during Qualification Testing	33
9.20.2 Operating Life during Lot Acceptance Testing	33
9.21 High Temperature Storage	34
9.22 High Temperature Reverse Bias Burn-in	34
9.23 Power Burn-in	34
10. <u>DATA DOCUMENTATION</u>	35
10.1 General	35
10.1.1 Qualification Approval	35
10.1.2 Testing Level 'B'	35
10.1.3 Testing Level 'C'	36
10.1.4 Data Retention/Data Access	36
10.2 Cover Sheet(s)	36
10.3 List of Equipment Used	37
10.4 List of Test References	37
10.5 Special In-process Control Data	37
10.6 Final Production Test Data	37
10.7 Burn-in and Electrical and Electro-Optical Measurement Data	38
10.7.1 Testing Level 'B'	38
10.7.2 Testing Level 'C'	38
10.8 Qualification Test Data	38
10.9 Lot Acceptance Test Data	38
10.9.1 Testing Level 'B'	38
10.9.2 Testing Level 'C'	38
10.10 Failed Components List and Failure Analysis Report	39
10.11 Certificate of Conformity	39
11. <u>DELIVERY</u>	39
12. <u>PACKAGING AND DESPATCH</u>	39
<u>CHARTS</u>	
I TESTING LEVELS	11
II FINAL PRODUCTION TESTS	19
III BURN-IN AND ELECTRICAL AND ELECTRO-OPTICAL MEASUREMENTS	20
IV QUALIFICATION TESTS	21
V LOT ACCEPTANCE TESTS	22
<u>ANNEXES</u>	
I LTPD SAMPLING PLAN FOR LOT SIZES GREATER THAN 200 DEVICES	40
LTPD SAMPLING PLAN FOR LOT SIZES LESS THAN, OR EQUAL TO, 200 DEVICES	41

**1. INTRODUCTION****1.1 SCOPE**

This specification defines the general requirements for the qualification approval, procurement, including lot acceptance testing, and delivery of Charge Coupled Devices, Silicon, Photosensitive, for space application.

This specification contains the appropriate inspection and test schedules and also specifies the data documentation requirements.

1.2 APPLICABILITY

This specification is primarily applicable to the granting of qualification approval to a component in accordance with ESA/SCC Basic Specification No. 20100 and the procurement of such components from qualified Manufacturers.

2. APPLICABLE DOCUMENTS

The following documents form part of, and shall be read in conjunction with, this specification. The relevant issues shall be those in effect on the date of placing the purchase order.

2.1 ESA/SCC SPECIFICATIONS

No. 20100, Requirements for the Qualification of Standard Electronic Components for Space Application.

No. 20400, Internal Visual Inspection.

No. 20500, External Visual Inspection.

No. 20600, Preservation, Packaging and Despatch of SCC Electronic Components.

No. 20900, Radiographic Inspection.

No. 21300, Terms, Definitions, Abbreviations, Symbols and Units.

No. 21400, Scanning Electron Microscope Inspection of Semiconductor Dice.

No. 21700, General Requirements for the Marking of SCC Components.

No. 22800, ESA/SCC Non-conformance Control System.

No. 22900, Total Dose Steady-State Irradiation Test Method.

No. 23500, Lead Materials and Finishes for Components for Space Application.

No. 23800, Electrostatic Discharge Sensitivity Test Method.

No. 24600, Minimum Quality System Requirements.



No. 24800, Resistance to Solvents of Marking, Materials and Finishes.

No. 25000, Electro-Optical Test Methods for Charge Coupled Devices.

With the exception of ESA/SCC Basic Specifications Nos. 20100, 21700, 22800 and 24600, where Manufacturers' specifications are equivalent to, or more stringent than, the ESA/SCC Basic Specifications listed above, they may be used in place of the latter, subject to the approval of the appropriate Qualifying Space Agency.

Such replacements shall be clearly identified in the applicable Process Identification Document (P.I.D.) and listed in an appendix to the appropriate Detail Specification.

Unless otherwise stated herein, references within the text of this specification to "the Detail Specification" shall mean the relevant ESA/SCC Detail Specification.

 	ESA/SCC Generic Specification No. 9020	-	PAGE 7 ISSUE 2
---	---	---	-------------------

2.2 OTHER (REFERENCE) DOCUMENTS

MIL-STD-105, Sampling Procedures and Tables for Inspection by Attributes.

MIL-STD-414, Sampling Procedures and Tables for Inspection by Variables for Per Cent Defective.

MIL-STD-883, Test Methods and Procedures for Micro-electronics.

ESA PSS-01-702, A Thermal Vacuum Test for the Screening of Space Materials.

2.3 ORDER OF PRECEDENCE

For the purpose of interpretation and in case of conflict with regard to documentation, the following order of precedence shall apply:-

- (a) ESA/SCC Detail Specification.
- (b) ESA/SCC Generic Specification.
- (c) ESA/SCC Basic Specification.
- (d) Other documents, if referenced herein.

3. TERMS, DEFINITIONS, ABBREVIATIONS, SYMBOLS AND UNITS

The terms, definitions, abbreviations, symbols and units specified in ESA/SCC Basic Specification No. 21300 shall apply.

4. REQUIREMENTS

4.1 GENERAL

The test requirements for the qualification approval of a component shall comprise radiation tests (see Para 5.2.2), final production tests (see Chart II), burn-in and electrical measurements to testing level 'B' (see Chart III) and qualification testing (see Chart IV).

The test requirements for procurement of components shall comprise radiation tests (see Para 5.2.2) if specified by the Orderer, final production tests (Chart II), burn-in and electrical measurements to testing level 'B' or 'C' as required (Chart III) together with, when applicable, a level of lot acceptance testing (see Chart V) to be specified by the Orderer.

If a Manufacturer elects to eliminate a final production test by substituting an in-process control or statistical process control procedure, the Manufacturer is still responsible for delivering components that meet all of the performance, quality and reliability requirements defined in this specification and the Detail Specification.

The qualification status of the procured components shall not be impaired by variations in the level of radiation testing called for in the purchase order.

4.1.1 Specifications

For qualification, procurement (including lot acceptance testing) and delivery of components in conformity with this specification, the specifications listed in Section 2 of this document shall apply in total unless otherwise specified herein or in the Detail Specification.

The Detail Specification shall specify a standard Variant (Variant 01). This Variant shall demonstrate the suitability of the device technology for space applications. Variant 01 shall be used as a qualification test vehicle.

4.1.2 Conditions and Methods of Test

The conditions and methods of test shall be in accordance with this specification, the ESA/SCC Basic Specifications referenced herein and the Detail Specification.



4.1.3 Manufacturer's Responsibility for Performance of Tests and Inspections

The Manufacturer shall be responsible for the performance of tests and inspections required by the applicable specifications. These tests and inspections shall be performed at the plant of the Manufacturer of the components unless it is agreed by the Qualifying Space Agency prior to commencing qualification testing, or procurement, to use an approved external facility.

4.1.4 Inspection Rights

The Qualifying Space Agency (for qualification approval or for a procurement) reserves the right to monitor any of the tests and inspections scheduled in the applicable specifications.

4.1.5 Pre-encapsulation or Post-encapsulation Inspection

Post-encapsulation inspection instead of pre-encapsulation inspection may be performed if the whole cavity can be inspected through the window of the CCD after sealing.

The Manufacturer shall notify the Orderer at least 2 working weeks before the commencement of pre-encapsulation or post-encapsulation inspection.

The Orderer shall indicate immediately whether or not he intends to witness the inspection.

4.2 QUALIFICATION APPROVAL REQUIREMENTS ON A MANUFACTURER

To obtain and maintain the qualification approval of a component, or family of components, a Manufacturer shall satisfy the requirements of ESA/SCC Basic Specification No. 20100.

4.3 DELIVERABLE COMPONENTS

Components delivered to this specification shall be processed and inspected in accordance with the relevant Process Identification Document (P.I.D.). Each delivered component shall be traceable to its production lot. Components delivered to this specification shall have completed satisfactorily all tests to the testing level and lot acceptance level specified in the purchase order (see Para 4.3.2).

ESA/SCC qualified components delivered to this specification shall be produced from lots that are capable of passing all tests, and sequences of tests, that are defined in Charts IV and V. The Manufacturer shall not knowingly supply components that cannot meet this requirement. In the event that, subsequent to delivery and prior to operational use, a component is found to be in a condition such that it could not have passed these tests at the time of manufacture, this shall be grounds for rejection of the delivered lot.



Components failing inspections and tests of the higher testing level (i.e. level 'B') shall not be supplied against any order for components of the lower testing level.

Components produced from lots where samples have failed the specified level of radiation testing shall not be delivered against orders requiring a lower level of radiation testing unless data is available to demonstrate that the samples passed that lower level. Should such data not be available, components shall not be delivered against orders requiring a lower level of radiation testing unless a sample is first retested to that lower level.

4.3.1 Lot Failure

Lot failure may occur during final production tests (Chart II), burn-in and electrical measurements (Chart III), qualification testing (Chart IV) or lot acceptance testing (Chart V).

Should such failure occur, the non-conformance procedure shall be initiated in accordance with ESA/SCC Basic Specification No. 22800.

		<p style="text-align: center;">ESA/SCC Generic Specification No. 9020</p>	<p>PAGE 9 ISSUE 2</p>
--	--	---	---------------------------

Should such failure occur during procurement, the Manufacturer shall notify the Orderer by telex within 2 working days, giving details of the number and mode of failure and the suspected cause.

In the case where qualification has been granted to the component, he shall, at the same time by the same means, inform the Qualifying Space Agency in order that the latter may consider its implications.

No further testing shall be performed on the failed components except on instruction from the Orderer. The Orderer shall inform the Manufacturer and the Qualifying Space Agency within 2 working days of receipt of the telex, by the same means, what action shall be taken.

In the case when lot failure occurs during qualification, the Manufacturer shall immediately notify the appropriate Qualifying Space Agency who will define a course of action to be followed. No further testing shall be performed on the failed components.

4.3.2 Testing and Lot Acceptance Levels

This specification defines six levels of radiation testing (see ESA/SCC Basic Specification No.22900), 2 levels of testing severity which are designated by the letters 'B' and 'C' (see Chart I) and 3 levels of lot acceptance testing (see Chart V).

The lot acceptance levels are designated 1, 2 and 3 and are comprised of tests as follows:-

- Level 3 (LA3) - Electrical Subgroup.
- Level 2 (LA2) - Endurance Subgroup
plus Electrical Subgroup.
- Level 1 (LA1) - Environmental and Mechanical Subgroup
plus Endurance Subgroup
plus Electrical Subgroup.

The required level of radiation testing, testing level and lot acceptance level shall be specified in the purchase order.

4.4 MARKING

All components procured and delivered to this specification from a source qualified according to ESA/SCC Basic Specification No. 20100 shall be marked in accordance with ESA/SCC Basic Specification No. 21700. Thus, they shall bear the ESA symbol to signify their conformance to the ESA/SCC qualification approval requirements and full compliance with the requirements of this specification and the Detail Specification.

Components procured from sources which are not ESA/SCC qualified, provided that they fully comply with the procurement requirements of this specification and the Detail Specification, may bear the SCC marking **with the exception of the ESA symbol.**

4.5 MATERIALS AND FINISHES

All non-metallic materials and finishes, that are not within a hermetically sealed enclosure, of the components specified herein shall meet the outgassing requirements as outlined in ESA PSS 01-702. Specific requirements for materials and finishes are specified in the Detail Specification.

**5. PRODUCTION CONTROL FOR QUALIFICATION****5.1 GENERAL**

The minimum requirements for production control, which are equally applicable to procurement, are defined in the Process Identification Document (P.I.D.).

5.2 SPECIAL IN-PROCESS CONTROLS**5.2.1 Scanning Electron Microscope (SEM) Inspection**

Level 'B' components supplied to this specification shall be produced from the wafer lots that have been subjected to, and successfully met, the scanning electron microscope inspection requirements in accordance with ESA/SCC Basic Specification No. 21400.

5.2.2 Total Dose Irradiation Testing

During qualification and maintenance of qualification:

- If specified in the Detail Specification, components shall be produced from a wafer lot which has been subjected to and successfully met the radiation requirements contained in ESA/SCC Basic Specification No. 22900.

During procurement:

- When required by the purchase order, components shall be produced from a wafer lot which has been subjected to and successfully met the radiation requirements contained in ESA/SCC Basic Specification No. 22900.

5.2.3 Rebonding

The rebonding of wires is not permitted.

5.2.4 Documentation

Documentation of special in-process controls shall be in accordance with the requirements of Para.10.5 of this specification.



CHART I - TESTING LEVELS

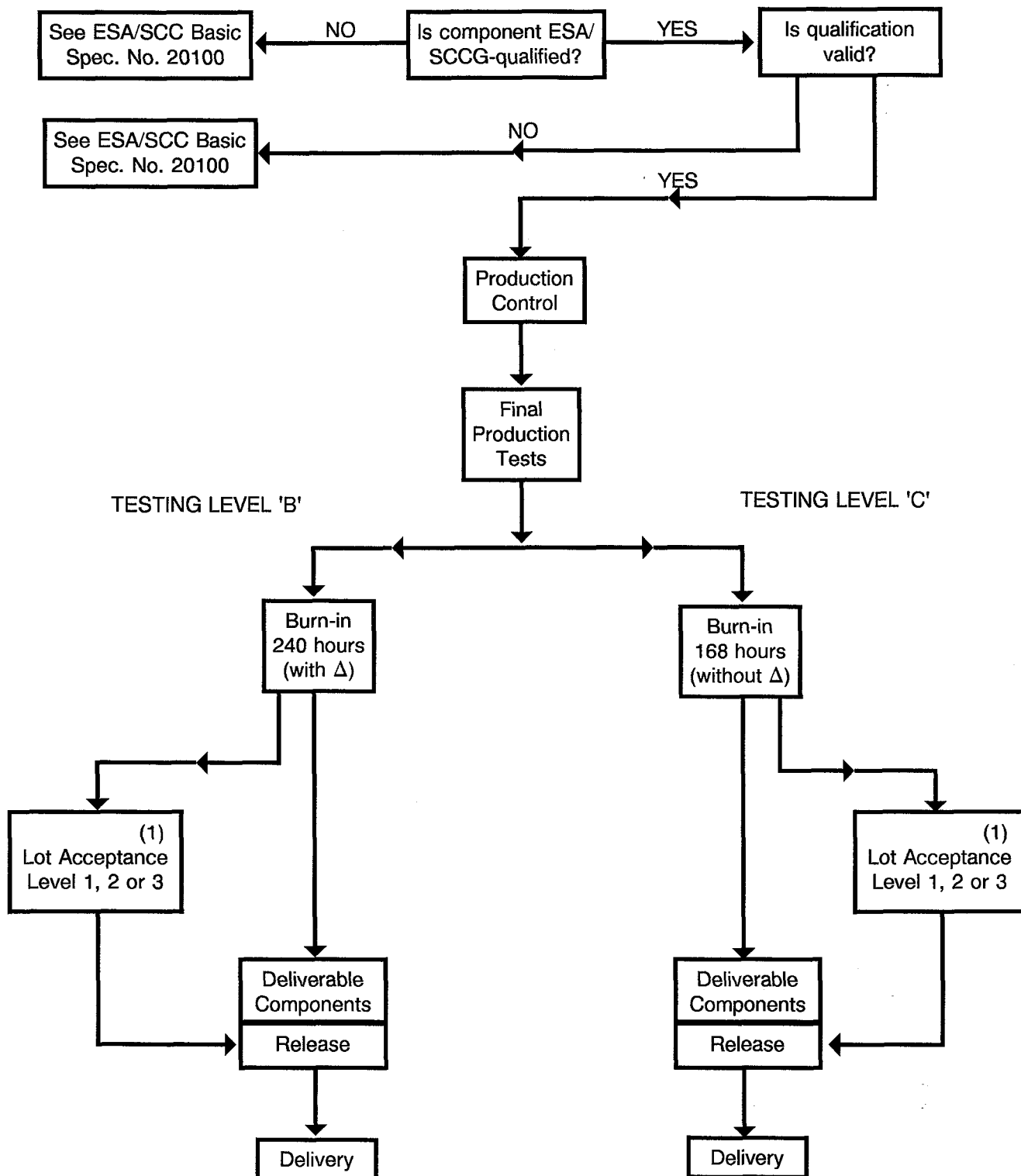

NOTES

1. When applicable.

**6. FINAL PRODUCTION TESTS****6.1 GENERAL**

Unless otherwise specified in the Detail Specification, all components used for qualification testing and all components for delivery, including those submitted to lot acceptance tests, shall be subjected to tests and inspections in accordance with Chart II.

Unless otherwise specified in the Detail Specification, the tests shall be performed in the order shown.

Any components that do not meet these requirements shall be removed from the lot and at no future time be re-submitted to the requirements of this specification.

6.2 TEST METHODS AND CONDITIONS

The applicable test methods and conditions are specified in the paragraphs referenced in Chart II of this specification.

6.3 DOCUMENTATION

Documentation of final production test data shall be in accordance with the requirements of Para. 10.6 of this specification.

7. BURN-IN AND ELECTRICAL MEASUREMENTS**7.1 GENERAL**

Unless otherwise specified in the Detail Specification, all components used for qualification testing and all components for delivery, including those submitted to lot acceptance tests, shall be subjected to tests and inspections in accordance with Chart III.

Unless otherwise specified in the Detail Specification, the tests shall be performed in the order shown.

The applicable test methods and conditions are specified in the paragraphs referenced in Chart III.

Components of testing level 'B' shall be serialised prior to the tests and inspections.

7.1.1 Conditions of Test

(a) Where applicable, the test conditions and duration for the High Temperature Reverse Bias (H.T.R.B.) burn-in shall be as shown in Table 5(a) of the Detail Specification.

For the applicable test methods and procedures, see Para. 9.22.

(b) The conditions for power burn-in shall be as shown in Table 5(b) of the Detail Specification.

Unless otherwise specified in the Detail Specification, components of level 'B' shall be subjected to a total power burn-in period of 240 hours and components of level 'C' to a total period of 168 hours. For the applicable test methods and procedures, see Para 9.23.

7.1.2 Data Points

For components of testing level 'B', undergoing the high temperature reverse bias test, the data points for parameter drift measurements shall be 0 hours (initial) and the test end point as specified in the Detail Specification.



For components of testing level 'B', undergoing a total power burn-in period of 240 hours, the data points for parameter drift measurements shall be 0 hours (initial) and 240(+ 24-0) hours (final).

For components of testing level 'C', undergoing a total power burn-in of 168 hours, the data point for post power burn-in electrical measurements shall be 168(+ 24-0) hours.

7.2 FAILURE CRITERIA

7.2.1 Parameter Drift Failure

The acceptable delta limits are shown in Table 4 of the Detail Specification. A component of testing level 'B' shall be counted as a parameter drift failure if the changes during high temperature reverse bias burn-in or during power burn-in are larger than the delta (Δ) values specified.

7.2.2 Parameter Limit Failure

A component shall be counted as a limit failure if one or more parameters exceed the limits shown in Tables 2 or 3 of the Detail Specification.

Any component which exhibits a limit failure prior to the burn-in sequence shall be rejected and not counted when determining lot rejection.

7.2.3 Other Failures

A component shall be counted as a failure in any of the following cases:

- Mechanical failure.
- Handling failure.
- Lost component.

7.3 FAILED COMPONENTS

A component shall be considered as a failed component if it exhibits one or more of the failure modes described in Para. 7.2 of this specification.

7.4 LOT FAILURE

In the case of lot failure, the Manufacturer shall act in accordance with the requirements of Para. 4.3.1 of this specification.

7.4.1 Lot Failure during 100% Testing



If the number of components failed on the basis of the failure criteria described in Para. 7.2 exceeds 10% (rounded upwards to the nearest whole number) of the number of components submitted to burn-in and electrical measurements, the lot shall be considered as failed.

If a lot is composed of groups of components of one family defined in one ESA/SCC Detail Specification, but separately identifiable for any reason, then the lot failure criteria shall apply separately to each identifiable group.

7.4.2 Lot Failure during Sample Testing

A lot shall be considered as failed if the number of allowable failures during sample testing in accordance with General Inspection Level II of MIL-STD-105 and the applicable AQL as specified in the Detail Specification, is exceeded.

In the case where an LTPD to MIL-STD-414 is specified in the Detail Specification, a lot shall be considered as failed if the number of failures allowed is exceeded (see Annexe I).

 	<p style="text-align: center;">ESA/SCC Generic Specification No. 9020</p>	<p style="text-align: center;">-</p>	<p>PAGE 14 ISSUE 2</p>
---	---	--------------------------------------	----------------------------

If a lot failure occurs in either case, a 100% testing may be performed with the lot failure criteria given in Para. 7.4.1.

7.5 DOCUMENTATION

Data documentation of burn-in and electrical measurements shall be in accordance with Para. 10.7 of this specification.

8. QUALIFICATION APPROVAL AND LOT ACCEPTANCE TESTS

8.1 QUALIFICATION TESTING

8.1.1 General

Qualification testing shall be in accordance with the requirements of Chart IV of this specification. The tests to Chart IV shall be performed on the specified sample, chosen at random from components which have successfully passed the tests in Charts II and III for testing level 'B'. This sample constitutes the qualification test lot.

The qualification test lot is divided into subgroups of tests and all components assigned to a subgroup shall be subjected to all of the tests in that subgroup, in the sequence shown.

The applicable test requirements are detailed in the paragraphs referenced in Chart IV.

The conditions governing qualification testing are given in ESA/SCC Basic Specification No. 20100, Para. 5.3 and, for the extension or renewal of qualification approval, in Paras. 6.3 and 6.4.

8.1.2 Distribution within the Qualification Test Lot

The qualification test lot shall be comprised in accordance with the following provisions, depending on whether it is required to obtain qualification approval for a single CCD component type or for a "family" of CCD component types.



8.1.2.1 Single CCD Component Type

When it is proposed to submit a single CCD component type for qualification testing, the sample quantity shall be as specified in Chart IV, Note 1. However, when such a single CCD component type is to be qualified in more than one type of package, each package variation must be equally represented in the environmental/mechanical subgroups (Subgroups I and II) and in the assembly/capability subgroup (Subgroup III). For this purpose, the applicable sample distribution shall be the same as for the qualification approval of a family of CCD component types as specified in Chart IV, Note 2 or Note 3.

8.1.2.2 Family of CCD Component Types

A family of CCD component types is a series of CCD's produced by the same manufacturing techniques, up to and including final sealing in their encapsulations, using the same types of machines and apparatus and using the same CCD design rules. Such CCD's will be designed for the same supply, signal voltages and loading rules. They shall be produced using the same technology (e.g. the same diffusion schedules, method of metallisation, etc.) and identical design rules. They may only differ in organisation and function.

Qualification approval may be granted to a family of CCD's subject to the successful outcome of the qualification testing of certain specified CCD component types to represent the family.

		<p style="text-align: center;">ESA/SCC Generic Specification No. 9020</p>	<p style="text-align: center;">-</p>	<p>PAGE 15 ISSUE 2</p>
--	--	---	--------------------------------------	----------------------------

Structurally similar CCD's from such a family may be grouped together for the purpose of selecting samples for qualification testing. The component types selected must adequately represent all of the various mechanical, structural, optical and electrical elements encountered within the family.

The component types chosen must be those that employ the extremes of design rules and tolerances and contain the maximum of internal sub-circuitry complexity, i.e. usually those that give the greatest risk of rejection.

When qualification approval is required for component types in more than one type of package, each package variation must be adequately represented in the environmental/mechanical subgroups (Subgroups I and II) and in the assembly/capability subgroup (Subgroup III).

The component types may be specified by, but in any case shall be agreed with, the Qualifying Space Agency, prior to the commencement of qualification testing and the justification for the selection shall be declared in the qualification test report.

The number of CCD types selected as representative of the family will therefore determine the total number of components comprising the qualification test lot. Depending on the number of types selected, the sample sizes shall be determined as follows:-

(a) Two types selected:

The sample quantity for each type shall be as specified in Chart IV, Note 2.

(b) Three or more types selected:

The sample quantity for each type shall be as specified in Chart IV, Note 3.

NOTES

1. In the case of four or more component types selected, different pass/fail criteria from those shown in Chart IV may be applicable. When appropriate, these shall be agreed with the Qualifying Space Agency prior to the commencement of qualification testing.

8.2 LOT ACCEPTANCE TESTING



8.2.1 General

The sample sizes of the 3 lot acceptance levels are specified in Chart V. All components assigned to a subgroup shall be subjected to all of the tests of that subgroup in the sequence shown.

The tests to Chart V shall be performed on the specified sample which shall have been chosen, whenever possible, at random from the proposed delivery lot (but see Para 8.2.3(b)). The applicable test requirements are detailed in the paragraph referenced in Chart V.

For a qualified Manufacturer, the failure of 1 component shall be permitted when this is completely attributable to a handling or other human error and can be demonstrated to have no bearing on the inherent quality or reliability of the lot. The Manufacturer shall prepare a report justifying this assessment for inclusion in the lot data documentation. The Manufacturer shall also ensure that appropriate measures are taken to prevent a reoccurrence of the error and make objective evidence of these preventative measures available to the relevant Qualifying Space Agency, when requested.

As a minimum for procurement of non-qualified components, lot acceptance level 3 tests shall apply. For procurement of qualified components, lot acceptance testing shall be performed if specified in a purchase order. Procurement lots ordered with a lot acceptance test level shall be delivered only after successful completion of lot acceptance testing.

		<p style="text-align: center;">ESA/SCC Generic Specification No. 9020</p>	<p style="text-align: center;">-</p>	<p>PAGE 16 ISSUE 2</p>
--	--	---	--------------------------------------	----------------------------

8.2.2 Distribution within the Sample for Lot Acceptance Testing

When components from the ordered lot are used, the sample for lot acceptance testing shall be comprised in accordance with the following provisions, depending on whether a single CCD component type or a family of CCD component types is considered.

8.2.2.1 Single CCD component type

When a single CCD component type is submitted to lot acceptance testing, the sample quantity shall be as specified in Chart V, Note 1. However, when such a single CCD component type is being procured in more than one type of package, each package variation must be equally represented in the environmental/mechanical subgroup (LA1) and the assembly/capability subgroup (LA3).

For this purpose, the applicable sample distribution shall be the same as for the lot acceptance of types from a family of CCD components as specified in Chart V, Note 2 or 3.

8.2.2.2 Family of CCD component types

When a purchase order involves a range or series of component types, drawn from a CCD family, the distribution of the component types for lot acceptance testing will normally vary from procurement to procurement.

The selection of component types for lot acceptance testing shall be agreed between the Manufacturer and the Orderer and specified by the Orderer.

Subject to the limitations of the range or series being procured, the component types selected should adequately represent all of the various mechanical, structural, optical and electrical elements encountered within the family (see also Para. 8.1.2.2). The component types for submission to lot acceptance level 1 and/or 2 shall be selected such as to adequately represent all types comprising the total procurement.

Component types for submission to lot acceptance level 3 shall be drawn from each delivery lot.

When component types are being procured in more than one type of package, each package variation must be adequately represented in the environmental/mechanical subgroup (LA1) and the assembly/capability subgroup (LA3).

The number of CCD types selected as representative of a particular procurement from a family will therefore determine the total number of components comprising the sample for lot acceptance testing.

Depending on the number of types selected, the sample sizes shall be determined as follows:-

(a) **Two types selected:**

The sample quantity for each type shall be as specified in Chart V, Note 2.

(b) **Three or more types selected:**

The sample quantity for each type shall be as specified in Chart V, Note 3.

NOTES

1. In the case of 4 or more types selected, different pass/fail criteria from those shown in Chart V may be applicable.

When appropriate, these shall be agreed between the Manufacturer and the Orderer prior to the commencement of lot acceptance testing.



8.2.3 Lot Acceptance Level 3 Testing (LA3)

Lot acceptance level 3 tests are designated as the electrical subgroup and comprise electrical and electro-optical measurement of characteristics and tests to prove the assembly capability of the component. For LA3 testing, the following requirements and conditions shall apply:-

- (a) LA3 testing shall be performed by the Manufacturer's quality assurance personnel using dedicated quality assurance equipment whenever possible. LA3 testing shall not be a repetition of routine measurements made by production personnel during final production tests and burn-in and electrical measurements.
- (b) When tests to Tables 2 and 3 of the Detail Specification have been performed on a sample basis, the components for LA3 testing shall be selected from this sample.
- (c) The electrical and electro-optical measurements for LA3 are considered to be non-destructive and therefore components so tested may form part of the delivery lot.
- (d) The solderability and terminal strength tests are considered to be destructive and therefore components so tested shall not form part of the delivery lot. Post-burn-in electrical rejects may be used for these tests.
- (e) When required in the purchase order, the Manufacturer shall notify the Orderer at least 2 working weeks before the commencement of LA3 testing. The Orderer shall indicate immediately whether or not he intends to witness the tests.

8.2.4 Lot Acceptance Level 2 Testing (LA2)

Lot acceptance level 2 testing shall comprise the tests for LA3 (electrical subgroup) plus tests on an endurance subgroup. For the electrical subgroup, the requirements and conditions as for LA3 (see Para. 8.2.3) shall apply.

For the endurance subgroup, the following shall apply:-

- (a) Components of testing level 'C', selected for the endurance subgroup, shall be serialised prior to the tests.
- (b) The tests in this subgroup are considered to be destructive and therefore components (of testing level 'B' or 'C') so tested shall not form part of the delivery lot.

8.2.5 Lot Acceptance Level 1 Testing (LA1)

Lot acceptance level 1 testing shall comprise the tests for LA3 (electrical subgroup) and LA2 (endurance subgroup) plus tests on an environmental and mechanical subgroup. For the electrical and endurance subgroups, the requirements and conditions for LA3 (see Para. 8.2.3) and LA2 (see Para. 8.2.4) respectively shall apply.

For the environmental subgroup, the following shall apply:-

- (a) Components of testing level 'C', selected for the environmental subgroup, shall be serialised prior to the tests.
- (b) The tests in this subgroup are considered to be destructive and therefore components (of testing level 'B' or 'C') so tested shall not form part of the delivery lot.



8.3 FAILURE CRITERIA

The following criteria shall apply to qualification testing and to lot acceptance testing.

8.3.1 Environmental and Mechanical Test Failures

The following shall be counted as component failures:-

Components which fail during tests for which the pass/fail criteria are inherent in the test method, e.g. seal, solderability, terminal strength, etc.

8.3.2 Electrical Failures

The following shall be counted as component failures:-

- (a) Components which, when subjected to electrical measurements on completion of environmental tests, in accordance with either Table 2 or Table 6, as specified in the Detail Specification, fail one or more of the applicable limits.
- (b) Components which, when subjected to electrical measurements at intermediate and end-points during endurance testing, in accordance with Table 6 of the Detail Specification, fail one or more of the applicable limits.
- (c) Components which, when subjected to measurement of electrical characteristics, in accordance with Tables 2 and 3 of the Detail Specification, fail one or more of the applicable limits.

8.3.3 Other Failures

The following additional failures may also occur during qualification testing or lot acceptance testing:-

- (a) Components failing to comply with the requirements of ESA/SCC Basic Specification No. 20500.
- (b) Lost components.

8.4 FAILED COMPONENTS

A component shall be considered as failed if it exhibits one or more of the failure modes detailed in Para 8.3 of this specification. The allowable number of failed components per subgroup, the aggregate failure constraints and the permitted distribution of such failures are shown at the foot of Charts IV and V of this specification.

When requested by the Qualifying Space Agency or the Orderer, failure analysis of failed components shall be performed by the Manufacturer and the results provided.

Failed components from successful lots shall be marked as such and be stored at the Manufacturer's plant for 24 months.

8.5 LOT FAILURE

A lot shall be considered as failed if the allowable number of failures according to Charts IV or V of this specification, as relevant, has been exceeded.

In the case of lot failure, the Manufacturer shall act in accordance with Para 4.3.1 of this specification.

8.6 DOCUMENTATION

For qualification testing, the qualification test data shall be documented in accordance with the requirements of Para 10.8 of this specification.

In the case of lot acceptance testing, the data shall be documented in accordance with the requirements of Para 10.9 of this specification.

**CHART II- FINAL PRODUCTION TESTS**Production and Controls in accordance with
Section 5 of this Specification

Production up to encapsulation stage

Para. 9.1.1	Internal (pre-encapsulation) Visual Inspection	(1)
Para. 9.2.1	Bond Strength Test	
Para. 9.2.2	Die-shear Test	
Para. 9.3	Encapsulation	
Para. 9.4	High Temperature Stabilisation Bake	
Para. 9.5	Temperature Cycling	
Para. 9.6	Constant Acceleration	
Para. 9.8.1 and Para. 9.8.2	Seal Test, Fine and Gross Leak (optional)	(2)
Para. 4.4	Marking (plus Serialisation for Level 'B')	
Para. 9.9.3	Electrical Measurements at Reference Temperature	
Para. 9.9.2	Electrical Measurements at High and Low Temperatures (optional)	(2)
Para. 9.15	Electro-optical Measurements (optional)	(2)
Para. 9.12	Geometrical Measurements (optional)	(2)
Para. 9.7	Mobile Particle Detection Test	(3)
Para. 9.1.2	Internal (post-encapsulation) Visual Inspection	(1)
Para. 9.10	External Visual Inspection, Sampling AQL 1%, Inspection Level II	
Para. 9.11	Dimension Check	(4)

TO CHART III

NOTES

1. See Para. 4.1.5.
2. The performance of these tests is left to the Manufacturer's discretion.
3. Testing level 'B' only.
4. May be performed at any point during the test sequence shown in this Chart.



CHART III - BURN-IN AND ELECTRICAL AND ELECTRO-OPTICAL MEASUREMENTS

Components from Final Production Tests		Testing Levels	
		B	C
Para. 9.9.1	Parameter Drift Value (Initial Measurements for H.T.R.B.)	X	-
Para 7.1.1(a) Para. 9.22	High Temperature Reverse Bias Burn-in	X	X
Para. 9.9.1	Parameter Drift Value (Final Measurements for H.T.R.B.; Initial Measurements for Power Burn-in)	X	-
Para. 7.1.1(b) and Para. 9.23	Power Burn-in 240 hours - Level 'B' 168 hours - Level 'C'	X -	- X
Para. 9.9.1	Parameter Drift Value (Final Measurements for Power Burn-in)	X	-
Para. 9.9.2	Electrical Measurements at High and Low Temperatures	X	X
Para. 9.9.3	Electrical Measurements at Reference Temperature (1)	X	X
Para. 9.15	Electro-optical Measurements (1) (2)	X	X
Para. 9.12	Geometrical Measurements (3)	X	X
Para. 9.8.1 Para. 9.8.2	Seal Test (Fine and Gross Leak) (3)	X	X
Para. 9.10	External Visual Inspection	X	X
Para. 7.4	Check for Lot Failure	X	X

TO CHART IV OR V

NOTES

1. The measurement of parameters for the calculation of drift value need not be repeated for electrical and electro-optical measurements at reference temperature.
2. Tests relevant to type variants other than standard (Variant 01) need not be performed on all devices. Rejects for type variants other than standard (Variant 01) shall not be counted for lot failure.
3. Rejects not to be counted for lot failure.



CHART IV - QUALIFICATION TESTS

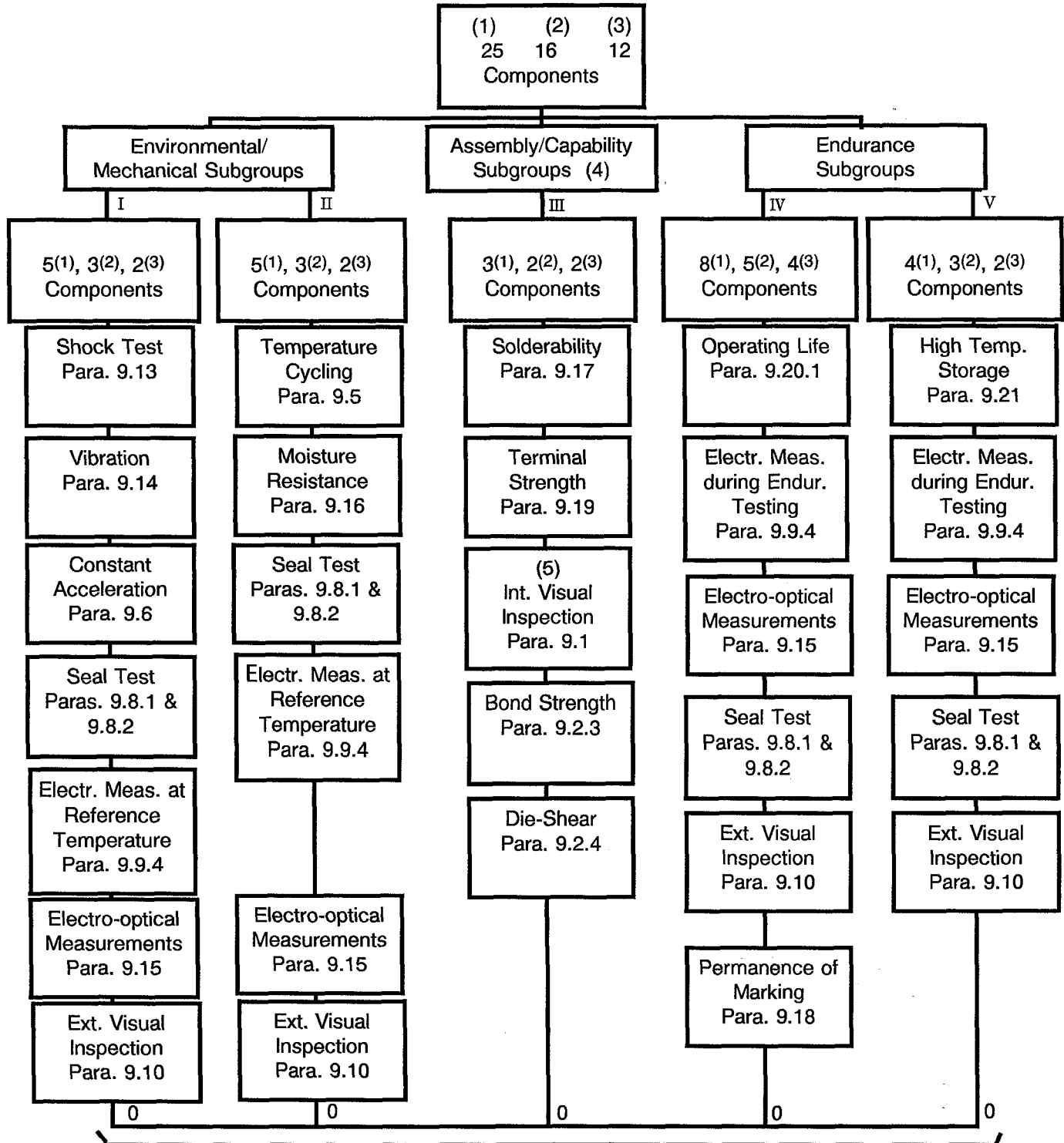

Total allowable number of failed components:0

NOTES

1. Single CCD type (see Para. 8.1.2.1).
2. 2 types selected (see Para. 8.1.2.2).
3. 3 or more types selected (see Para. 8.1.2.2).
4. These parts may be electrical or electro-optical rejects that should be capable of passing Internal Visual Inspection, Bond Strength and Die-Shear tests after delidding.
5. Both pre-encapsulation and post-encapsulation inspections shall be performed.



CHART V - LOT ACCEPTANCE TESTS

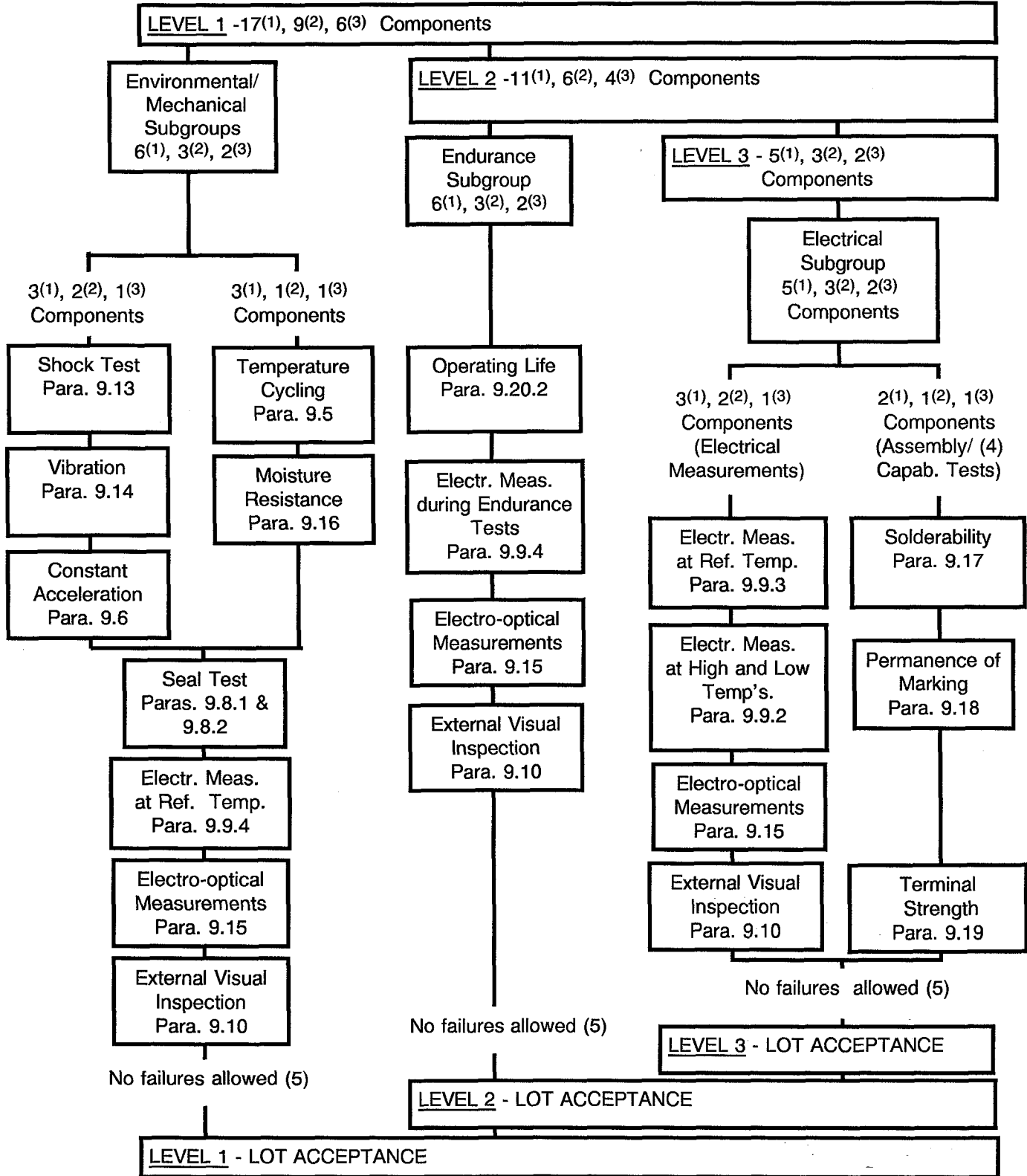

NOTES

1. Single CCD type (see Para. 8.2.2.1).
2. 2 types selected (see Para. 8.2.2.2).
3. 3 or more types selected (see Para. 8.2.2.2).
4. Post burn-in electrical rejects may be used for these tests.
5. See Para. 8.2.1.

**9. TEST METHODS AND PROCEDURES**

If a Manufacturer elects to eliminate or modify a test method or procedure, the Manufacturer is still responsible for delivering components that meet all of the performance, quality and reliability requirements defined in this specification and the Detail Specification.

Documentation supporting the change shall be approved by the Qualifying Space Agency and retained by the Manufacturer. It shall be copied, when requested, to the Qualifying Space Agency.

The change shall be specified in the Detail Specification and in the P.I.D.

9.1 INTERNAL VISUAL INSPECTION**9.1.1 Pre-encapsulation Inspection (Low Magnification)**

In accordance with ESA/SCC Basic Specification No. 20400.

9.1.2 Post-encapsulation Inspection (High Magnification)

In accordance with ESA/SCC Basic Specification No. 20400.

9.2 BOND STRENGTH AND DIE-SHEAR TESTS

N.B. These tests are destructive.

9.2.1 Bond Strength Test during Final Production Tests**(a) Test Conditions:**

MIL-STD-883, Test Method 2011.

- Test Condition 'C' or 'D' for thermo-compression, ultrasonic or wedge-bonding.
- Test Condition 'F' for flip-chip bonding.
- Test Condition 'G' or 'H' for beam lead bonding.

(b) Test Procedures:

1. For device types having internal bonding wires numbering 8 or less, select 3 components at random from the lot accepted.

Test all bonds.

2. For device types having internal bonding wires numbering between 9 and 24, select 2 components at random from the lot accepted.

Test all bonds.

3. For device types having internal bonding wire numbering 25 or more, select 2 components at random from the lot accepted.

Test 50% of the bonds on each component.

If agreed by the Q.S.A. (for qualification approval) or the Orderer (for a procurement), the components used for this test may have passed the low magnification phase only of the Internal Visual Inspection (Para. 9.1).

N.B.

The low magnification phase of the Internal Visual Inspection is that part of the inspection (at a magnification of < 100) that addresses the bonds, bond wires and die mount.

(c) Accept/Reject Criteria:

Individual separation forces and categories shall be recorded. A single failure shall be cause for rejection of the lot.

**9.2.2 Die-Shear Test during Final Production Tests****(a) Test Conditions:**

MIL-STD-883, Test Method 2019.

(b) Test Procedures:

Perform the test on the components previously submitted to the bond strength test.

(c) Accept/Reject Criteria:

Individual separation forces and categories shall be recorded. A single failure shall be cause for rejection of the lot.

9.2.3 Bond Strength Test during Qualification Testing**(a) Test Conditions:**

As per Para. 9.2.1(a).

(b) Test Procedures:

As per Para. 9.2.1(b), but components to be selected from those in Subgroup III of Chart IV.

(c) Accept/Reject Criteria:

As per Para. 9.2.1(c).

9.2.4 Die-Shear Test during Qualification Testing**(a) Test Conditions:**

As per Para. 9.2.2(a).

(b) Test Procedures:

Perform the test on the components in Subgroup III of Chart IV.

(c) Accept/Reject Criteria:

As per Para. 9.2.2(c).

9.3 ENCAPSULATION

In accordance with the Process Identification Document (P.I.D.).

9.4 HIGH TEMPERATURE STABILISATION BAKE

MIL-STD-883, Test Method 1008. Duration: 48 hours at maximum storage temperature rating specified in Table 1(b) of the Detail Specification.

9.5 TEMPERATURE CYCLING

MIL-STD-883, Test Method 1010, Test Condition: 'B'.

9.6 CONSTANT ACCELERATION

MIL-STD-883, Test Method 2001, Test Condition: 'E'; to be performed in plane Y₁ only. For CCDs which have a package weight of 5.0 grammes or more, condition 'D' will be used.

9.7 MOBILE PARTICLE DETECTION

MIL-STD-883, Test Method 2020, Test condition 'A'. The use of the same attachment medium for the Sensitivity Test Unit (S.T.U.) and for the components under test (D.U.T.) is not mandatory. An internal visual inspection (as per Para. 9.1) with location of particles shall be performed before and after shaking the device. If a particle has moved away from its initial position, the component shall be rejected.

Complementary to the visual inspection, the photoresponse non-uniformity may be measured (see ESA/SCC Basic Specification No. 25000) before and after shaking the device. The limits and tests conditions shall be indicated in the Detail Specification.

**9.8 SEAL TEST****9.8.1 Seal Test, Fine Leak**

MIL-STD-883, Test Method 1014, Condition 'A' or 'B'.

9.8.2 Seal Test, Gross Leak

MIL-STD-883, Test Method 1014, Condition 'D'.

9.9 ELECTRICAL MEASUREMENTS**9.9.1 Parameter Drift Value Measurements**

At each of the relevant data points for components of testing level 'B', measurements shall be made of all parameters listed in Table 4 of the Detail Specification. All values obtained shall be recorded against serial numbers and the parameter drift calculated.

9.9.2 Electrical and Electro-optical Measurements at High and Low Temperatures

For components of testing levels 'B' or 'C', the electrical and electro-optical measurements at high and low temperatures shall be made in accordance with Table 3 of the Detail Specification. Where sample testing is applied, note the requirements of Para. 8.2.3(b). For testing level 'B', all values obtained shall be recorded against serial numbers.

9.9.3 Electrical and Electro-optical Measurements at Reference Temperature

For components of testing levels 'B' or 'C', the electrical and electro-optical measurements shall be made in accordance with Table 2 of the Detail Specification. Where sample testing is applied, note the requirements of Para. 8.3.3(b). For testing level 'B', all values obtained shall be recorded against serial numbers.

9.9.4 Parameter Measurements during Environmental, Mechanical and Endurance Testing

At each of the relevant data points specified for environmental, mechanical and endurance testing, measurements shall be made of all parameters listed in Table 6 of the Detail Specification. All values obtained shall be recorded against serial numbers and the parameter drift calculated, if required.

9.10 EXTERNAL VISUAL INSPECTION

In accordance with ESA/SCC Basic Specification No. 20500.

9.11 DIMENSION CHECK

In accordance with ESA/SCC Basic Specification No. 20500 and the Detail Specification. To be performed on 5 samples only.

If a failure occurs, the complete lot shall be checked.

9.12 GEOMETRICAL MEASUREMENTS

Geometrical measurements shall be performed on a 100% basis, unless otherwise specified in the Detail Specification (Figure 2(b)).



9.12.1 Mechanical and Optical References

If a package reference is given by mechanical engineering (holes, fixing screw, etc.), it will be used.

Otherwise the following system of cartesian coordinates is defined by:

- OX axis: tangent axis along external perimeter, parallel to package in longitudinal direction.
- OY axis: tangent axis along external perimeter, parallel to package in transversal direction.
- OZ axis: perpendicular axis to XOY plane, oriented to form a direct referential.

In this referential, the package is oriented such as the notch or dot is close to the origin and the photosensitive zone is oriented towards positive Z axis.

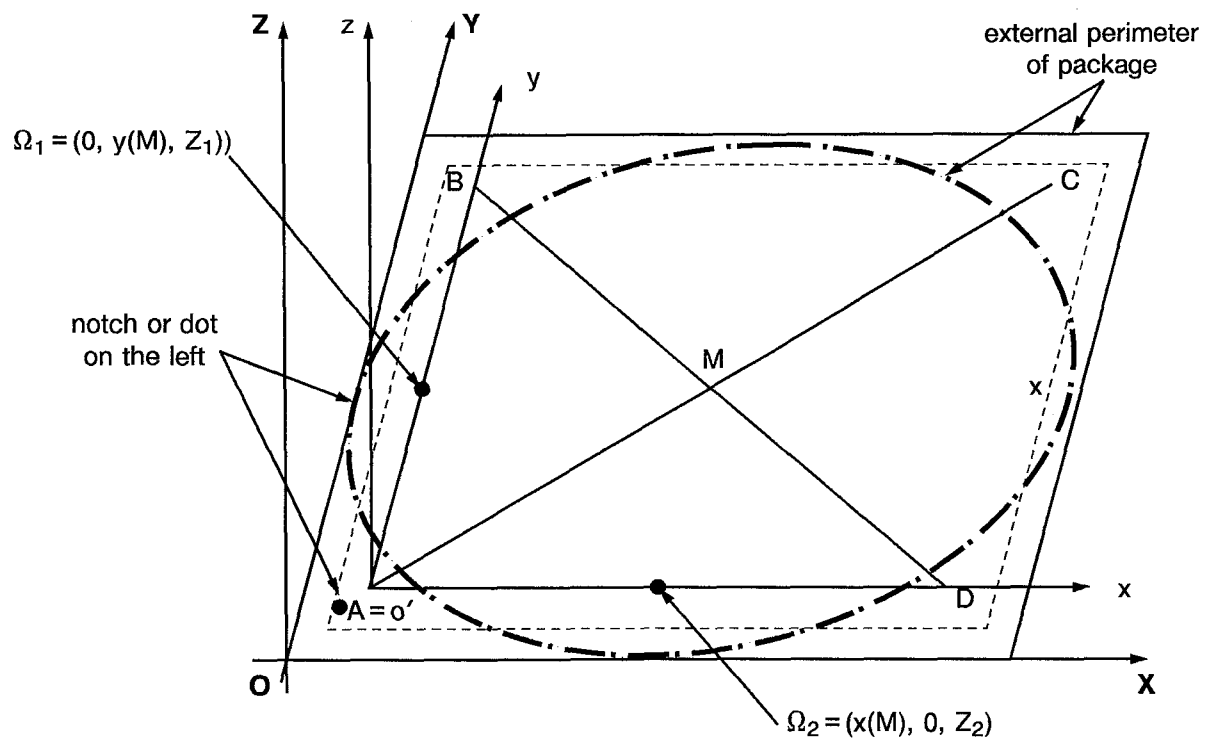

(o' , x , y , z) is optical reference of image plane with:

- o' : physical reference point of the surface of the image plane (edge of optical mask, specific marks, etc.) situated nearest the first useful readout pixel. This point is in position A, B, C or D for area array image sensor.
- M: middle point of image plane.

9.12.2 Flatness of Image Area

9.12.2.1 Definition

The distance between two parallel planes of sufficient and necessary separation to enclose all points on the surface.



9.12.2.2 Principle

To determine the deviations (Δz) along a line through the middle of the image plane with regard to an origin point (Ω) situated at coordinate:

- either: Ω_0 , the reference point o' (first pixel of linear image sensor)
- or: Ω_1 , the point $(O, y(M), Z_1)$ for area image sensors
- or: Ω_2 , the point $(x(M), O, Z_2)$ for area image sensors.

with a defined step "p".

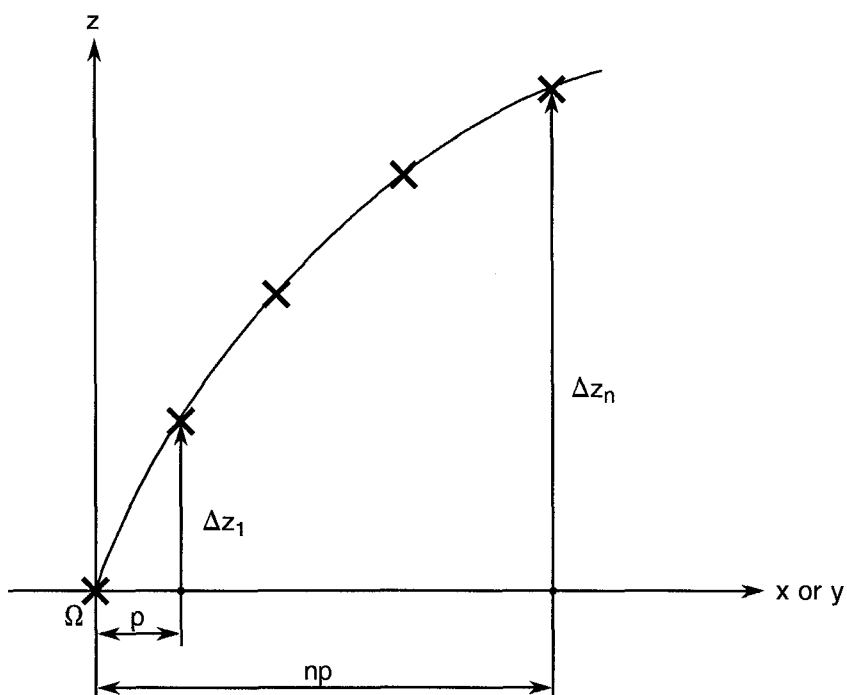

NOTES

1. Step "p" : 2.0mm for line > 10mm.
"p" : 1.0mm for line ≤ 10 mm.
2. M = middle point of image plane.



9.12.2.3 Measurement and Data Processing

After the drift acquiring (see Para. 9.12.2.2), the flatness curve is obtained by means of a polynomial interpolation between the measurement points. At least the equation is quadratic, and to the maximum this is an equation of degree (N-1) where N is the number of measurement points.

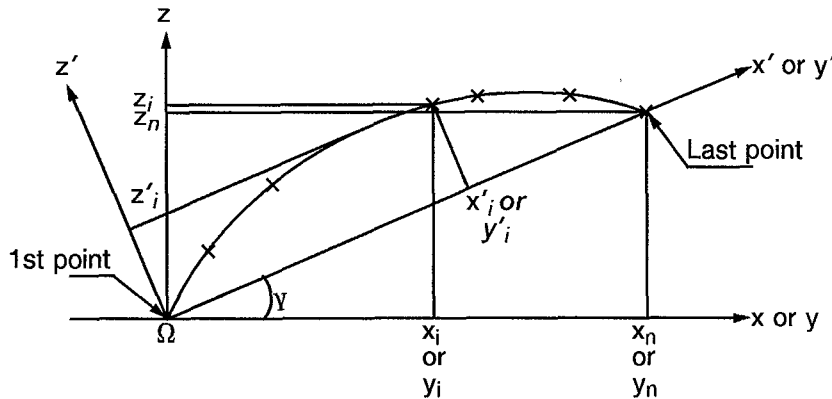

with (Ω_0, x, z) or (Ω_1, x, z) or (Ω_2, y, z) : measurement axis
 (Ω_0, x', z') or (Ω_1, x', z') or (Ω_2, y', z') : reference axis to define flatness.

$$\gamma: \text{Arctg} \frac{z_n}{x_n} \text{ or } \frac{z_n}{y_n}$$

γ : angle between Ωx and $\Omega x'$ or Ωy and $\Omega y'$

and coordinate translation

$$\begin{pmatrix} x'_i \\ z'_i \end{pmatrix} = \begin{pmatrix} \cos \gamma & \sin \gamma \\ -\sin \gamma & \cos \gamma \end{pmatrix} \begin{pmatrix} x_i \\ z_i \end{pmatrix} \quad \text{or}$$

$$\begin{pmatrix} y'_i \\ z'_i \end{pmatrix} = \begin{pmatrix} \cos \gamma & \sin \gamma \\ -\sin \gamma & \cos \gamma \end{pmatrix} \begin{pmatrix} y_i \\ z_i \end{pmatrix}$$

from which:

$$\begin{aligned} z'_i &= -x_i \sin \gamma + z_i \cos \gamma & \text{or} & & z'_i &= -x_i \sin \gamma + z_i \cos \gamma \\ x'_i &= x_i \cos \gamma + z_i \sin \gamma & & & y'_i &= y_i \cos \gamma + z_i \sin \gamma \end{aligned}$$

The flatness curve is obtained by interpolation between $(x'_i \text{ or } y'_i, z'_i)$. The curve can be concave or convex, following the positioning of these points along $\Omega x'$ or $\Omega y'$ axis.

The flatness of image area is defined by:

$$P = \text{Max} (z'_i \text{ positive}) + \text{Max} |z'_i \text{ (negative)}|$$



9.12.3 Position of First Pixel

9.12.3.1 Definition

Coordinates X and Y with regard to origin (O) defined in Para. 9.12.1., i.e.:

- first readout pixel on a linear detector.
- first readout pixel (first line, first column intersection pixel) on an area array detector.

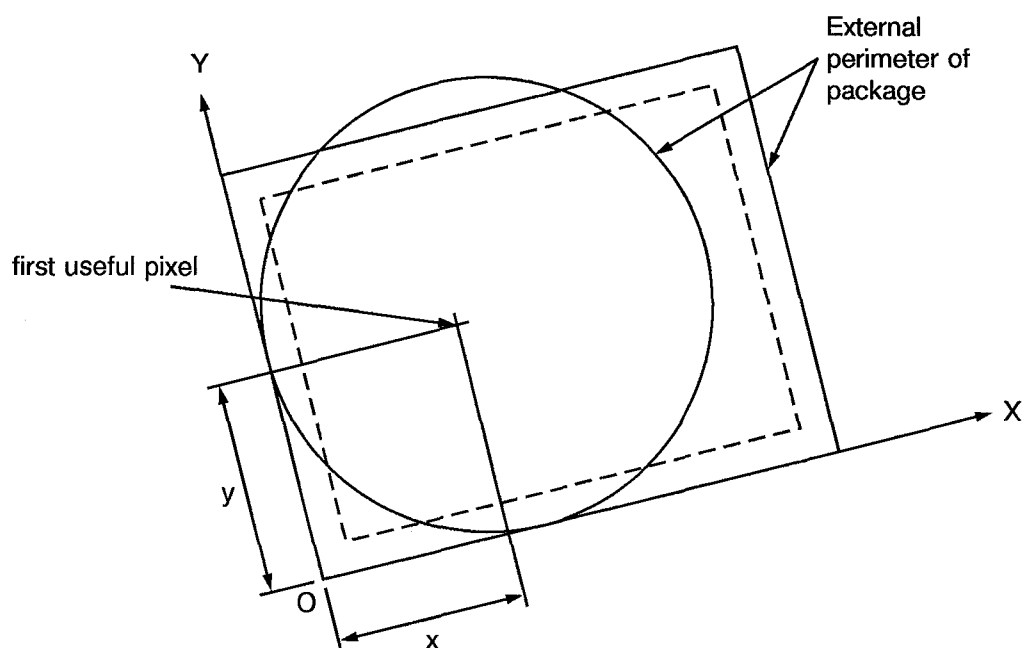

NOTES

1. The optical origin can be an edge of optical mask, specific marks, etc.

9.12.3.2 Principle

Positioning of package in accordance with figure defined in Para. 9.12.1.

9.12.3.3 Measurement

Data collection X and Y of the first pixel.



9.12.4 Image Plane Orientation (Skew)

9.12.4.1 Definition

Angular value θ between reference package axis X defined in Para. 9.12.1 and photosensitive line(s) or column(s).

The angle can be positive or negative.

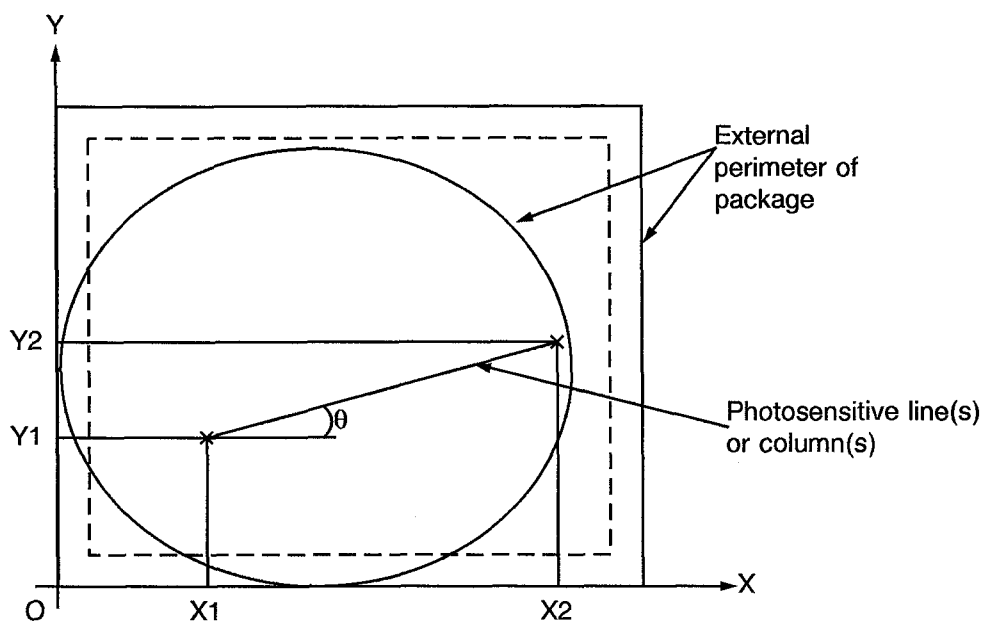

9.12.4.2 Principle

Positioning of package in accordance with figure defined in Para. 9.12.1.

9.12.4.3 Measurement and Data Processing

Data collection X_1 , X_2 and Y_1 , Y_2 of the first and last pixels (line or column) unless otherwise specified in the Detail Specification (Figure 2(b)).

The image plane orientation is given by:

$$\theta = \text{Arc tan } \frac{Y_2 - Y_1}{X_2 - X_1}$$

NOTES

1. Reference point of measurement can be an edge of optical mask.

9.12.5 Optical Distance between Image Plane and Window

9.12.5.1 Definition

The mean optical distance Z is the distance between the photosensitive plane and the external window surface, calculated in the middle of photosensitive area.

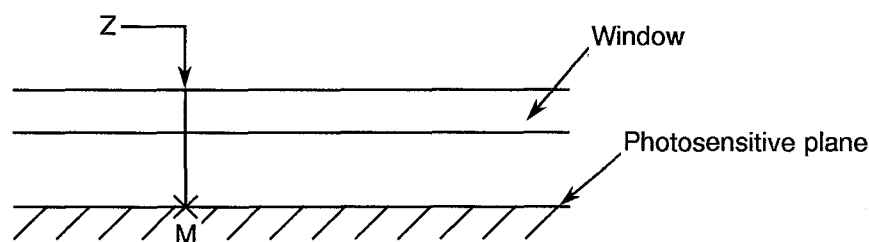

9.12.5.2 Principle

To acquire values of 3 optical distances Z_1 , Z_2 and Z_3 with:

(a) linear image sensor:

- Z_1 : above the first pixel
- Z_2 : above the last pixel
- Z_3 : above the middle pixel

(b) area array image sensor:

- Z_1 : above the first pixel of the first line
- Z_2 : above the last pixel of the first column (Note 1)
- Z_3 : above the last pixel of the first line

NOTES

1. This value is used for parallelism calculation in Para. 9.12.6.

9.12.5.3 Measurement and Data Processing

Data collection Z_1 , Z_2 and Z_3 .



The optical distance between image plane and window is defined by:

(a) linear image sensor

$$Z = \frac{1}{2} \left[\left(\frac{Z_1 + Z_2}{2} \right) + Z_3 \right]$$

(b) area array image sensor

$$Z = \frac{1}{2} \left(Z_2 + Z_3 \right)$$

		<p style="text-align: center;">ESA/SCC Generic Specification No. 9020</p>	<p style="text-align: center;">-</p>	<p>PAGE 32 ISSUE 2</p>
--	--	---	--------------------------------------	----------------------------

9.12.6 Parallelism between Image Plane and Window

9.12.6.1 Definition

Maximum tilt between image plane and window plane.

9.12.6.2 Principle

See Para. 9.12.5.2

9.12.6.3 Measurement and Data Processing

Data collection Z1, Z2, Z3.

The parallelism is defined by:

$$\text{TILT} = \max (Z1, Z2, Z3) - \min (Z1, Z2, Z3)$$

9.12.7 Image Plane Dimensions

9.12.7.1 Definition

Value of length (L) and width (W) of the image plane with:

- L : distance between first and last pixels of the first line
- W : distance between first and last pixels of the same column

9.12.7.2 Principle

Positioning of package in accordance with plane (o', x, y) (see Para. 9.12.1).

9.12.7.3 Measurement

Data collection of coordinate:

- first and last pixels of the first line: x_1 and x_2 (Note 1)
- first and last pixels of the same column: y_1 and y_2 (Note 1)

The image plane dimension is defined by:

$$L = x_2 - x_1$$

and:

$$W = y_2 - y_1 \text{ (Note 2)}$$

NOTES

1. Edge of optical mask, specific marks can be used.
2. Only for area array image sensor.

**9.13 SHOCK TEST**

MIL-STD-883, Test Method 2002, Test Condition: 'B'.

9.14 VIBRATION

MIL-STD-883, Test Method 2007, Test Condition: 'A'.

9.15 ELECTRO-OPTICAL MEASUREMENTS

In accordance with Paragraph 6 of ESA/SCC Basic Specification No. 25000 (Paragraph 5 of ESA/SCC Basic Specification No. 25000 specifies electrical measurements). Electro-optical measurements shall be performed as per Tables 2, 3 and 6 of the Detail Specification on a 100% basis, unless otherwise specified in the Detail Specification (Table 1(a)), using the conditions specified in the Detail Specification.

9.16 MOISTURE RESISTANCE

MIL-STD-883, Test Method 1004.

9.17 SOLDERABILITY

MIL-STD-883, Test Method 2003, to be performed on all terminals.

The use of activated fluxes (RMA and RA or OA) shall be allowed on leadless devices with gold finished terminals. All activated fluxes must be immediately cleaned off after dipping using an acceptable solvent in accordance with Para. 4.3 of ESA/SCC Basic Specification No. 23500.

9.18 PERMANENCE OF MARKING

In accordance with ESA/SCC Basic Specification No. 24800.

9.19 TERMINAL STRENGTH

MIL-STD-883, Test Method 2004, Test Condition 'D' for chip carrier packages or Test Condition 'B2' for all other packages. For Condition 'B2', 3 leads (excluding corner leads) or 10% of the leads (whichever is greater) are to be randomly selected on each component of the sample.

9.20 OPERATING LIFE**9.20.1 Operating Life during Qualification Testing**

MIL-STD-883, Test Method 1005.

Duration: 2000 hours.

Test conditions: As specified in the Detail Specification.

Data points

Measurements at intermediate and end points according to Table 6 of the Detail Specification at 0, 1000 ± 48 hours and 2000 ± 48 hours. In the case where Table 6 specifies "changes", the drift shall always be related to the 0-hour measurement.

9.20.2 Operating Life during Lot Acceptance Testing

MIL-STD-883, Test Method 1005.

Duration: 1000 hours.

Test conditions: As specified in the Detail Specification.

Data points

Measurements at 0 hours and at 1000 ± 48 hours according to Table 6 of the Detail Specification.

 SCC	ESA/SCC Generic Specification No. 9020	-	PAGE 34 ISSUE 2
---	---	---	--------------------

9.21 HIGH TEMPERATURE STORAGE

MIL-STD-883, Test Method 1008.

Duration: 2000 hours.

Test conditions: As specified in the Detail Specification.

Data points

Measurements at intermediate and end points according to Table 6 of the Detail Specification at 0, 1000 ± 48 hours and 2000 ± 48 hours. In the case where Table 6 specifies "changes", the drift shall always be related to the 0-hour measurement.

9.22 HIGH TEMPERATURE REVERSE BIAS BURN-IN

MIL-STD-883, Test Method 1015, Test Condition 'A'. Test conditions as specified in the Detail Specification.

9.23 POWER BURN-IN

MIL-STD-883, Test Method 1015, Test Condition 'B', 'D' or 'E'. Test conditions as specified in the Detail Specification.

**10. DATA DOCUMENTATION****10.1 GENERAL**

For the qualification approval records and with each component delivery, a data documentation package is required. Depending on the testing level and lot acceptance level specified for the component, this package shall be compiled from:-

- (a) Cover sheet (or sheets).
- (b) List of equipment (testing and measuring).
- (c) List of test references.
- (d) Special in-process control test data.
- (e) Final production test data (Chart II) (but see Para. 10.6).
- (f) Burn-in and electrical and electro-optical measurement data (Chart III).
- (g) Qualification test data (Chart IV).
- (h) Lot acceptance test data (Chart V) (when applicable).
- (i) Failed components list (see Paras. 7.3 and 8.4) and failure analysis report (see Para 8.4).
- (j) Certificate of Conformity.
- (k) S.E.M. photographs.

Items (a) to (k) inclusive shall be grouped, preferably as subpackages and, for identification purposes, each page shall include the following information:

- ESA/SCC Component Number.
- Manufacturer's name.
- Lot identification.
- Date of establishment of the document.
- Page number.



10.1.1 Qualification Approval

In the case of qualification approval, the items listed in Para 10.1 (a) to (k) less item (h) are required.

10.1.2 Testing Level 'B'**10.1.2.1 Qualified Components**

For deliveries of qualified components, the following documentation shall be supplied:-

- (a) Cover sheet (if all of the information is not included on the Certificate of Conformity).
- (b) Certificate of Conformity (including range of delivered serial numbers).
- (c) Attributes record of measurements, tests and inspections performed in Chart II, Chart III (including PDA figure) and Chart V (where applicable).
- (d) Failed components list.

		<p style="text-align: center;">ESA/SCC Generic Specification No. 9020</p>	<p style="text-align: center;">-</p>	<p>PAGE 36 ISSUE 2</p>
--	--	---	--------------------------------------	----------------------------

10.1.2.2 Unqualified Components

For deliveries of unqualified components, the documentation to be supplied shall be in accordance with Para. 10.1.2.1 plus the following:-

- (a) Read and record data from Chart III.
- (b) Special in-process control data (where applicable).
- (c) Failure analysis report on failed components.

10.1.3 Testing Level 'C'

10.1.3.1 Qualified Components

For deliveries of qualified components, the following documentation shall be supplied:-

- (a) Certificate of Conformity.

10.1.3.2 Unqualified Components

For deliveries of unqualified components, the documentation to be supplied shall be in accordance with Para. 10.1.3.1 plus the following:-

- (a) Cover sheet (if all of the information is not included on the Certificate of Conformity).
- (b) Attributes record of all measurements, tests and inspections performed in Charts II, III and V (when applicable).
- (c) Failed components list (including Failure Analysis Report).
- (d) Special in-process control data (when applicable).

10.1.4 Data Retention/Data Access

If not delivered, all data shall be retained by the Manufacturer for a minimum of 5 years during which time it shall be available to the Qualifying Space Agency and the Orderer, if requested, for review. The Manufacturer shall deliver variables Data/Reports to the Orderer if required by the Purchase Order.

10.2 COVER SHEET(S)

The cover sheet(s) of the data documentation package shall include as a minimum:-

- (a) Reference to the Detail Specification, including issue and date.
- (b) Reference to the applicable ESA/SCC Generic Specification, including issue and date.
- (c) Component type and number.
- (d) Lot identification.
- (e) Range of delivered serial numbers (for components of testing level 'B').
- (f) Number of purchase order.
- (g) Radiation testing level.
- (h) Information relative to any additions to this specification and/or the Detail Specification.
- (i) Manufacturer's name and address.
- (j) Location of the manufacturing plant (specify place of diffusion, assembly and test).
- (k) Signature on behalf of Manufacturer.
- (l) Total number of pages of the data package.

**10.3 LIST OF EQUIPMENT USED**

A list of equipment used for tests and measurements shall be prepared, if not in accordance with the data given in the Process Identification Document (P.I.D.). Where applicable, this list shall contain inventory number, Manufacturer's type number, serial number, etc. This list shall indicate for which tests such equipment was used.

10.4 LIST OF TEST REFERENCES

This list shall include all Manufacturer's references or codes which are necessary to correlate the test data provided with the applicable tests specified in the tables of the Detail Specification.

10.5 SPECIAL IN-PROCESS CONTROL DATA

Data of S.E.M. inspection shall be provided in accordance with the requirements of ESA/SCC Basic Specification No. 21400.

Irradiation test report shall be provided in accordance with the requirements of ESA/SCC Basic Specification No. 22900 (if required).

10.6 FINAL PRODUCTION TEST DATA (CHART II)

A test result summary shall be compiled showing the total number of components submitted to, and the total number rejected after each of the following tests:

- Pre-encapsulation internal visual inspection (Para. 9.1).
- Bond strength and die-shear tests (Para. 9.2).
- Seal test (fine and gross leak) (Para. 9.8) (when applicable).
- Environmental tests (Paras. 9.4, 9.5, 9.6 and 9.7).
- Electrical and electro-optical measurements at high and low temperatures (Para. 9.9.2) (when applicable).
- Electrical and electro-optical measurements at reference temperature (Para. 9.9.3).
- External visual inspection (Para.9.10).
- Dimension check (Para. 9.11).

For the bond strength and die-shear tests, the separation forces and categories shall be recorded.

The final production test data shall form an integral part of the data documentation package, but it is not a mandatory requirement that it be delivered with the qualification lot or delivery lot. However, the data package to be delivered shall contain the information as detailed in Paras. 10.1.2 and 10.1.3 or at least shall contain a list of final production tests actually performed and a certification that the data is available for review.

**10.7 BURN-IN AND ELECTRICAL AND ELECTRO-OPTICAL MEASUREMENT DATA (CHART III)****10.7.1 Testing Level 'B'**

For components of testing level 'B', all data shall refer to the relevant serial numbers. Against these serial numbers, data shall be recorded for the following:-

- (a) H.T.R.B. burn-in measurements and delta values (if applicable).
- (b) 0-hour measurement for power burn-in.
- (c) 240 hour measurement for power burn-in.
- (d) Delta values after power burn-in.
- (e) Values obtained during measurements at high and low temperatures (Table 3 of the Detail Specification).
- (f) Values obtained during measurements of electrical characteristics (Table 2 of the Detail Specification).
- (g) Failures during seal test.
- (h) Failures during external visual inspection.

10.7.2 Testing Level 'C'

For components of testing level 'C', a test result summary (i.e. the total number of components subjected to, and the total number rejected from, each of the tests and inspections) shall be prepared.

10.8 QUALIFICATION TEST DATA (CHART IV)

All data shall be referenced to the relevant serial numbers. Detailed records shall be provided of the components submitted to each test in each of the subgroups and of those rejected. Detailed data shall be provided of all electrical and electro-optical measurements made in accordance with Tables 2 and 6 of the Detail Specification, as and where applicable.

10.9 LOT ACCEPTANCE TEST DATA (CHART V)**10.9.1 Testing Level 'B'**

All data shall be referenced to the relevant serial numbers. Detailed records shall be provided of the components submitted to each test in each of the subgroups (as relevant to the lot acceptance level) and of those rejected.



Detailed data shall be provided of all electrical and electro-optical measurements made in accordance with Tables 2, 3 and 6 of the Detail Specification, as and where applicable.

10.9.2 Testing Level 'C'

A test result summary (i.e. the total number of components submitted to, and the total number rejected from, each of the tests and inspections) as relevant to the lot acceptance level shall be provided.

In the case of lot acceptance 2 testing, all data in respect of electrical and electro-optical measurements made in accordance with Table 6 of the Detail Specification shall be referenced to the relevant serial numbers (see Para. 8.2.4(a)).

In the case of lot acceptance 1 testing, all data in respect of electrical and electro-optical measurements made in accordance with Tables 2, 3 and 6 of the Detail Specification shall be referenced to the relevant serial numbers (see Para. 8.2.5(a)).

 	<p style="text-align: center;">ESA/SCC Generic Specification No. 9020</p>	<p style="text-align: center;">-</p>	<p>PAGE 39 ISSUE 2</p>
---	---	--------------------------------------	----------------------------

10.10 FAILED COMPONENTS LIST AND FAILURE ANALYSIS REPORT

The failed components list and failure analysis report shall provide full details of:-

- (a) The reference number and description of the test or measurement performed as defined in this specification and/or the Detail Specification.
- (b) The serial number (if applicable) of the failed component.
- (c) The failed parameter and the failure mode of the component.
- (d) Detailed failure analysis, if requested.
- (e) In the case of an allowed failure during Chart V (see Para. 8.2.1), a report shall always be supplied.

10.11 CERTIFICATE OF CONFORMITY

A Certificate of Conformity shall be established as defined in ESA/SCC Basic Specification No. 20100.

11. DELIVERY

For qualification approval, the disposition of the qualification test lot and its related documentation shall be as specified in ESA/SCC Basic Specification No. 20100 and the relevant paragraphs of Section 10 of this specification.

For procurement, for each order, the items forming the delivery are:-

- (a) The delivery lot.
- (b) The components used for lot acceptance testing, (when applicable), but not forming part of the delivery lot (see Para's 8.2.3(d), 8.2.4(b) and 8.2.5(b)).
- (c) The relevant documentation in accordance with the requirements of Section 10 of this specification.

In the case of a component for which a valid qualification approval is in force, all data of all components submitted to LA1 and LA2 testing shall also be copied, when requested, to the relevant Qualifying Space Agency.

12. PACKAGING AND DESPATCH

The packaging and despatch of components to this specification shall be in accordance with the requirements of ESA/SCC Basic Specification No. 20600.



ANNEXE I

LTPD SAMPLING PLAN LOT SIZES GREATER THAN 200 DEVICES

Minimum size of sample to be tested to assure with a 90% confidence that a lot whose Percent Defective equals the specified LTPD is not accepted (single sample).

Max. Percent Defective (LTPD) or λ	50	30	20	15	10	7	5	3	2	1.5	1	0.7	0.5	0.3	0.2	0.15	0.1
Acceptance Number (c) ($r = c + 1$)	MINIMUM SAMPLE SIZES (FOR DEVICE-HOURS REQUIRED FOR LIFE TEST, MULTIPLY BY 1000)																
0	5 (1.03)	8 (0.64)	11 (0.46)	15 (0.34)	22 (0.23)	32 (0.16)	45 (0.11)	76 (0.07)	116 (0.04)	153 (0.03)	231 (0.02)	328 (0.02)	461 (0.01)	767 (0.007)	1152 (0.005)	1534 (0.003)	2303 (0.002)
1	8 (4.4)	13 (2.7)	18 (2.0)	25 (1.4)	38 (0.94)	55 (0.65)	77 (0.46)	129 (0.28)	195 (0.18)	258 (0.14)	390 (0.09)	555 (0.06)	778 (0.045)	1296 (0.027)	1946 (0.018)	2592 (0.013)	3891 (0.009)
2	11 (7.4)	18 (4.5)	25 (3.4)	34 (2.24)	52 (1.6)	75 (1.1)	105 (0.78)	176 (0.47)	266 (0.31)	354 (0.23)	533 (0.15)	759 (0.11)	1065 (0.080)	1773 (0.045)	2662 (0.031)	3547 (0.022)	5323 (0.015)
3	13 (10.5)	22 (6.2)	32 (4.4)	43 (3.2)	65 (2.1)	94 (1.5)	132 (1.0)	221 (0.62)	333 (0.41)	444 (0.31)	668 (0.20)	953 (0.14)	1337 (0.10)	2226 (0.062)	3341 (0.041)	4452 (0.031)	6681 (0.018)
4	16 (12.3)	27 (7.3)	38 (5.3)	52 (3.9)	78 (2.6)	113 (1.8)	158 (1.3)	265 (0.75)	398 (0.50)	531 (0.37)	798 (0.25)	1140 (0.17)	1599 (0.12)	2663 (0.074)	3997 (0.049)	5327 (0.037)	7994 (0.025)
5	19 (13.8)	31 (8.4)	45 (6.0)	60 (4.4)	91 (2.9)	131 (2.0)	184 (1.4)	308 (0.85)	462 (0.57)	617 (0.42)	927 (0.28)	1323 (0.20)	1855 (0.14)	3090 (0.085)	4638 (0.056)	6181 (0.042)	9275 (0.028)
6	21 (15.6)	35 (9.4)	51 (6.6)	68 (4.9)	104 (3.2)	149 (2.2)	209 (1.6)	349 (0.94)	528 (0.62)	700 (0.47)	1054 (0.31)	1503 (0.22)	2107 (0.155)	3509 (0.093)	5267 (0.062)	7019 (0.047)	10533 (0.031)
7	24 (16.6)	39 (10.2)	57 (7.2)	77 (5.3)	116 (3.5)	166 (2.4)	234 (1.7)	390 (1.0)	589 (0.67)	783 (0.51)	1178 (0.34)	1680 (0.24)	2355 (0.17)	3922 (0.101)	5886 (0.067)	7845 (0.051)	11771 (0.034)
8	26 (18.1)	43 (10.9)	63 (7.7)	85 (5.6)	128 (3.7)	184 (2.6)	258 (1.8)	431 (1.1)	648 (0.72)	864 (0.54)	1300 (0.36)	1854 (0.25)	2599 (0.18)	4329 (0.108)	6498 (0.072)	8660 (0.054)	12995 (0.036)
9	28 (19.4)	47 (11.5)	69 (8.1)	93 (6.0)	140 (3.9)	201 (2.7)	282 (1.9)	471 (1.2)	709 (0.77)	945 (0.58)	1421 (0.38)	2027 (0.27)	2842 (0.19)	4733 (0.114)	7103 (0.077)	9468 (0.057)	14206 (0.038)
10	31 (19.9)	51 (12.1)	75 (8.4)	100 (6.3)	152 (4.1)	218 (2.9)	306 (2.0)	511 (1.2)	770 (0.80)	1025 (0.60)	1541 (0.40)	2199 (0.28)	3082 (0.20)	5133 (0.120)	7704 (0.080)	10268 (0.060)	15407 (0.040)
11	33 (21.0)	54 (12.8)	83 (8.3)	111 (6.2)	166 (4.2)	238 (2.9)	332 (2.1)	555 (1.2)	832 (0.83)	1109 (0.62)	1664 (0.42)	2378 (0.29)	3323 (0.21)	5546 (0.12)	8319 (0.083)	11092 (0.062)	16638 (0.042)
12	36 (21.4)	59 (13.0)	89 (8.6)	119 (6.5)	178 (4.3)	254 (3.0)	356 (2.2)	594 (1.3)	890 (0.86)	1187 (0.65)	1781 (0.43)	2544 (0.3)	3562 (0.22)	5936 (0.13)	8904 (0.086)	11872 (0.065)	17808 (0.043)
13	38 (22.3)	63 (13.4)	95 (8.9)	126 (6.7)	190 (4.5)	271 (3.1)	379 (2.26)	632 (1.3)	948 (0.89)	1264 (0.67)	1896 (0.44)	2709 (0.31)	3793 (0.22)	6321 (0.134)	9482 (0.089)	12643 (0.067)	18964 (0.045)
14	40 (23.1)	67 (13.8)	101 (9.2)	134 (6.9)	201 (4.6)	288 (3.2)	403 (2.3)	672 (1.4)	1007 (0.92)	1343 (0.69)	2015 (0.46)	2878 (0.32)	4029 (0.23)	6716 (0.138)	10073 (0.092)	13431 (0.069)	20146 (0.046)
15	43 (23.3)	71 (14.1)	107 (9.4)	142 (7.1)	213 (4.7)	305 (3.3)	426 (2.36)	711 (1.41)	1066 (0.94)	1422 (0.71)	2133 (0.47)	3046 (0.33)	4265 (0.235)	7108 (0.141)	10662 (0.094)	14216 (0.070)	21324 (0.047)
16	45 (24.1)	74 (14.0)	112 (9.7)	150 (7.2)	225 (4.8)	321 (3.37)	450 (2.41)	750 (1.44)	1124 (0.96)	1499 (0.72)	2249 (0.48)	3212 (0.337)	4497 (0.241)	7496 (0.144)	11244 (0.096)	14992 (0.072)	22487 (0.048)
17	47 (24.7)	79 (14.7)	118 (9.86)	158 (7.36)	236 (4.93)	338 (3.44)	473 (2.46)	788 (1.48)	1182 (0.98)	1576 (0.74)	2364 (0.49)	3377 (0.344)	4728 (0.246)	7880 (0.148)	11819 (0.098)	15759 (0.074)	23639 (0.049)
18	50 (24.9)	83 (15.0)	124 (10.0)	165 (7.54)	248 (5.02)	354 (3.51)	496 (2.51)	826 (1.51)	1239 (1.0)	1652 (0.75)	2478 (0.50)	3540 (0.351)	4956 (0.251)	8260 (0.151)	12390 (0.100)	16520 (0.075)	24780 (0.050)
19	52 (25.5)	86 (15.4)	130 (10.2)	173 (7.76)	259 (5.12)	370 (3.58)	518 (2.56)	864 (1.53)	1296 (1.02)	1728 (0.77)	2591 (0.52)	3702 (0.358)	5183 (0.256)	8638 (0.153)	12957 (0.102)	17276 (0.077)	25914 (0.051)
20	54 (26.1)	90 (15.6)	135 (10.4)	180 (7.82)	271 (5.19)	386 (3.65)	541 (2.60)	902 (1.56)	1353 (1.04)	1803 (0.78)	2705 (0.52)	3864 (0.364)	5410 (0.260)	9017 (0.156)	13526 (0.104)	18034 (0.078)	27051 (0.052)
26	65 (27.0)	109 (16.1)	163 (10.8)	217 (8.08)	326 (5.38)	466 (3.76)	652 (2.69)	1086 (1.61)	1629 (1.08)	2173 (0.807)	3259 (0.538)	4656 (0.376)	6518 (0.269)	10863 (0.161)	16295 (0.108)	21726 (0.081)	32589 (0.054)

NOTES

1. Sample sizes are based upon the Poisson exponential binomial limit.
2. The minimum quality (approximate AQL) required to accept (on the average) 19 of 20 lots is shown in parentheses for information only.



ANNEXE I

LTPD SAMPLING PLAN LOT SIZES LESS THAN, OR EQUAL TO, 200 DEVICES

C=0													
N	10	20	30	40	50	60	80	100	120	150	160	200	
n	AQL LTPD	AQL LTPD	AQL LTPD	AQL LTPD	AQL LTPD	AQL LTPD	AQL LTPD	AQL LTPD	AQL LTPD	AQL LTPD	AQL LTPD	AQL LTPD	AQL LTPD
2	2.2 65	2.5 66	2.5 67	2.5 67	2.5 67	2.5 68	2.5 68	2.5 68	2.5 68	2.5 68	2.5 68	2.5 68	2.5 68
4	1.2 36	1.2 40	1.2 42	1.2 42	1.3 42	1.3 43	1.3 43	1.3 43	1.3 43	1.3 43	1.3 43	1.3 44	1.3 44
5	1.0 29	1.0 33	1.0 34	1.0 35	1.0 35	1.0 35	1.0 36	1.0 36	1.0 37	1.0 37	1.0 37	1.0 37	1.0 37
8	0.5 15	0.6 20	0.6 22	0.6 23	0.6 23	0.6 23	0.6 24	0.7 24	0.7 24	0.7 24	0.7 24	0.7 24	0.7 25
10		0.4 15	0.5 17	0.5 19	0.5 19	0.5 19	0.5 20	0.5 20	0.5 20	0.5 20	0.5 20	0.5 20	0.5 20
16		0.2 6.9	0.25 10	0.25 11	0.3 11	0.3 12	0.3 12	0.3 13	0.3 13	0.3 13	0.3 13	0.3 13	0.3 13
20			0.2 6.8	0.2 8.0	0.25 8.7	0.25 9.0	0.25 9.4	0.25 10	0.25 10	0.25 10	0.25 10	0.25 10	0.25 11
25			0.15 4.3	0.15 5.7	0.2 6.4	0.2 6.9	0.2 7.4	0.2 7.5	0.2 7.6	0.2 7.7	0.2 7.8	0.2 7.8	0.2 7.9
32				0.1 3.7	0.1 4.4	0.1 5.0	0.1 5.5	0.1 5.9	0.15 6.0	0.15 6.2	0.15 6.3	0.15 6.3	0.15 6.3
40					0.1 3.0	0.1 3.4	0.1 4.0	0.1 4.5	0.1 4.6	0.1 4.9	0.1 5.0	0.1 5.0	0.15 5.0
50						0.1 2.3	0.1 2.9	0.10 3.3	0.10 3.5	0.10 3.7	0.10 3.7	0.10 3.7	0.10 3.9
64							0.08 1.7	0.08 2.2	0.08 2.5	0.08 2.7	0.08 2.8	0.08 2.8	0.08 2.9
80								0.07 1.5	0.07 1.7	0.07 2.0	0.07 2.1	0.07 2.1	0.07 2.2
100									0.05 1.1	0.05 1.5	0.05 1.5	0.05 1.5	0.05 1.7
125										0.04 0.8	0.04 0.9	0.04 0.9	0.04 1.2
128											0.04 0.8	0.04 0.9	0.04 1.1
160												0.03 0.7	0.03 0.7
C=1													
N	10	20	30	40	50	60	80	100	120	150	160	200	
n	AQL LTPD	AQL LTPD	AQL LTPD	AQL LTPD	AQL LTPD	AQL LTPD	AQL LTPD	AQL LTPD	AQL LTPD	AQL LTPD	AQL LTPD	AQL LTPD	AQL LTPD
2	27 95	24 95	24 95	23 95	23 95	23 95	23 95	23 95	23 95	22 95	22 95	22 95	22 95
4	15 62	12 66	12 66	11 67	11 67	10 67	10 67	10 67	10 67	9.8 67	9.7 67	9.7 68	9.7 68
5	13 51	10 55	8.8 56	8.5 57	8.4 57	8.1 58	7.9 58	7.6 58	7.5 58	7.5 58	7.5 58	7.5 58	7.5 58
8	11 28	7.2 35	6.2 38	5.8 38	5.4 39	5.0 39	4.7 39	4.5 39	4.3 39	4.3 40	4.2 40	4.2 40	4.2 40
10		6.2 30	5.0 30	4.6 31	4.2 32	4.2 32	4.2 32	4.2 32	3.9 33	3.5 33	3.3 33	3.3 33	3.3 33
16		5.6 15	4.2 18	3.8 18	3.4 20	3.0 20	2.9 21	2.6 21	2.5 21	2.3 21	2.3 22	2.3 22	2.2 22
20			4.0 13	3.2 15	2.8 16	2.5 16	2.4 16	2.3 16	2.1 17	2.0 17	2.0 17	2.0 17	2.0 18
25			3.8 9.2	3.1 11	2.5 12	2.2 13	2.0 13	1.8 13	1.7 13	1.6 14	1.6 14	1.6 14	1.6 14
32				3.1 7.4	2.4 8.2	2.1 9.0	1.8 9.9	1.6 10	1.5 10.5	1.4 11	1.3 11	1.3 11	1.3 11
40					2.4 5.9	2.1 6.8	1.6 7.6	1.4 7.8	1.3 8.2	1.2 8.3	1.2 8.4	1.2 8.4	1.2 8.6
50						1.7 4.6	1.4 5.6	1.2 6.1	1.2 6.4	1.0 6.5	0.9 6.7	0.9 6.7	0.9 6.7
64							1.3 3.8	1.1 4.4	1.0 4.7	0.8 5.0	0.8 5.0	0.7 5.2	0.7 5.2
80								1.1 3.0	1.0 3.4	0.8 3.7	0.7 3.8	0.6 4.0	0.6 4.0
100									0.9 2.5	0.7 2.8	0.7 2.8	0.6 3.0	0.6 3.0
125										0.7 1.9	0.7 2.0	0.5 2.2	0.5 2.2
128										0.7 1.7	0.7 1.9	0.5 2.2	0.5 2.2
160												0.5 1.5	0.5 1.5
C=2													
N	10	20	30	40	50	60	80	100	120	150	160	200	
n	AQL LTPD	AQL LTPD	AQL LTPD	AQL LTPD	AQL LTPD	AQL LTPD	AQL LTPD	AQL LTPD	AQL LTPD	AQL LTPD	AQL LTPD	AQL LTPD	AQL LTPD
4	33 82	28 83	27 84	27 85	27 85	26 85	26 85	26 86	26 86	25 86	25 86	25 86	25 86
5	27 69	23 73	21 74	20 74	20 74	20 75	20 75	19 75	19 75	19 75	19 75	19 75	19 75
8	22 42	15 49	14 49	13 52	13 52	13 52	12 53	12 53	12 53	11 53	11 53	11 53	11 53
10		13 39	11 42	11 42	10 43	10 43	9.6 43	9.2 44	9.1 44	8.9 44	8.9 44	8.7 44	8.7 44
16		11 22	8.6 25	6.9 27	6.8 27	6.4 27	6.0 28	6.0 29	5.9 29	5.9 29	5.7 29	5.5 30	5.5 30
20			7.7 19	6.2 21	5.9 22	5.6 22	5.1 23	4.8 23	4.8 23	4.6 23	4.5 24	4.5 24	4.5 24
25			7.4 13	6.0 16	4.9 17	4.5 17	4.3 18	4.1 18	3.9 18	3.7 18	3.7 19	3.7 19	3.7 19
32				5.5 11	4.8 12	4.3 13	3.6 14	3.4 14	3.2 14	3.0 14.5	3.0 15	2.9 15	2.9 15
40					4.6 8.9	3.9 9.8	3.1 11	2.8 12	2.6 12	2.4 12	2.4 12	2.3 12	2.3 12
50						3.5 6.9	2.8 8.1	2.4 8.4	2.3 8.6	2.1 9.0	2.1 9.3	2.0 9.5	2.0 9.5
64							2.6 5.7	2.2 6.2	2.0 6.6	1.8 7.1	1.7 7.1	1.6 7.4	1.6 7.4
80								2.1 4.5	1.8 4.9	1.6 5.4	1.5 5.4	1.4 5.6	1.4 5.6
100									1.8 3.5	1.4 3.9	1.4 4.0	1.2 4.4	1.2 4.4
125										1.4 2.8	1.3 2.9	1.1 3.3	1.1 3.3
128										1.4 2.6	1.3 2.9	1.1 3.2	1.1 3.2
160												1.1 2.3	1.1 2.3

**ANNEXE I****Page 3 of 3**

This table gives the AQL and LTPD values associated with certain single sampling plans (Acceptance Number "C", Sample Size "n" and Lot Size "N"). The table has the following features:-

- (a) Calculations are based upon the hyper-geometric distribution (exact theory) for lot sizes of 200 devices or less.
- (b) The AQL of a sampling plan is defined as the interpolated Percent Defective for which there is a 0.95 probability of acceptance under the plan. The AQL so defined need not be a realisable Lot Percent Defective for the lot size involved (e.g., 12 percent is not a realisable Percent Defective for a lot size of 20 devices).
- (c) The LTPD of a sampling plan is defined as the interpolated Percent Defective for which there is a 0.10 probability of lot acceptance under the plan. The LTPD so defined need not be a realisable Lot Percent Defective for the lot size involved.
- (d) The sequence of sample sizes and lot sizes are generated by taking products of preceding numbers in the respective sequences and the numbers 2 and 5.