



SINGLE EVENT EFFECTS RADIATION TEST REPORT

Part Type : BUK456-200A

Package : TO-220AB

N-Channel Power MOSFET

Philips

Report Reference : ESA_QCA990902S_C

Issue : 01

Date : July 2nd 1999

ESA Contract No 13413/98/NL/MV dated 25/01/99

European Space Agency Contract Report

The work described in this report was done under ESA contract.
Responsibility for the contents resides in the author or organization that prepared it

ESTEC Technical Officer : R. Harboe Sorensen

Hirex reference :	HRX/99.4597	Issue : 01	Date :	July 2, 1999
Prepared by :	H. CONSTANS/FX GUERRE		Date :	
Approved by :	F.X GUERRE		Date :	

	SEE TEST REPORT HRX/99.4597		Rev. -	PAGE 2 ISSUE 1 July 2, 1999
	Part Type :	BUK456-200A	Manufacturer	Philips

TABLE OF CHANGES

Issue 1 July 2, 1999
 Original Issue

	SEE TEST REPORT HRX/99.4597		Rev. -	PAGE 3 ISSUE 1 July 2, 1999
	Part Type :	BUK456-200A	Manufacturer	Philips

TABLE OF CONTENTS

I.	ABSTRACT	4
II.	INTRODUCTION	5
III.	DOCUMENTS	5
III.1	APPLICABLE DOCUMENTS	5
III.2	REFERENCE DOCUMENTS	5
IV.	DEVICE INFORMATION	6
IV.1	DEVICE DESCRIPTION	6
IV.2	PROCUREMENT OF TEST SAMPLES	6
IV.3	PREPARATION OF SAMPLES	6
IV.4	SAMPLES CHECK OUT	6
IV.5	DEVICE MARKING	6
V.	DEVICE TEST DEFINITION	7
V.1	PREPARATION OF TEST HARDWARE AND PROGRAM	7
V.2	GENERIC TEST SET-UP	7
V.2.1	Mother board description (Ref. IL140A)	7
V.2.2	DUT Test board description	10
V.3	TEST CONFIGURATION	10
V.3.1	Single Event burnout (SEB)	10
V.3.2	Single Event Gate Rupture (SEGR)	11
VI.	TEST FACILITIES	12
VI.1	HEAVY IONS	12
VI.1.1	Beam Source	12
VI.1.2	Beam Set-up	12
VII.	HEAVY IONS RESULTS	13
VII.1	BUK456-200A TEST RESULTS	13
VII.2	TYPICAL SEB WAVEFORM	13
VIII.	CONCLUSION	14

FIGURES

Figure 1 – Device marking	6
Figure 2 - Generic Test Set-up	8
Figure 3 – Functional diagram for SEE Test	9
Figure 4 – Equivalent circuit for SEB including the parasitic capacitor of the MOSFET.	10
Figure 5 – Example of non destructive SEBs observed on a 100V transistor at 60V and 70V Vds ratings	13

TABLES

Table 1 – Test circuit resistor values	10
Table 2 – Heavy Ion Test results on BUK456-200A N-Channel Power MOSFET from Philips :	15

	SEE TEST REPORT HRX/99.4597		Rev. -	PAGE 4 ISSUE 1 July 2, 1999
	Part Type :	BUK456-200A	Manufacturer	Philips

I. **ABSTRACT**

Under ESA/ESTEC contract n° 13413/98/NL/MV covering "Radiation Evaluation of Power MOSFET Devices from Different European Manufacturers", a large number of commercial Power MOSFET device types were radiation assessed. Results from these assessments, primarily focused on the radiation sensitivity of the MOSFETs to Total Ionizing Dose (TID) and Single Event Effects (SEE), are reported in individual TID and SEE reports. Below summary table list manufacturer and evaluated types, and give references to the various reports issued.

Manufacturer	Type	TID Report	SEE Report
Philips	PHP50N06T	ESA_QCA990901T_C	ESA_QCA990901S_C
Philips	BUK456-200A	ESA_QCA990902T_C	ESA_QCA990902S_C
Motorola	MTP50N06VL	ESA_QCA990903T_C	
Motorola	MTW32N20E	ESA_QCA990904T_C	
Motorola	MTP50N06V	ESA_QCA990905T_C	
Siemens	BUZ100S	ESA_QCA990906T_C	ESA_QCA990906S_C
Siemens	BUZ100SL	ESA_QCA990907T_C	ESA_QCA990907S_C
Siemens	BUZ341	ESA_QCA990908T_C	ESA_QCA990908S_C
SGS-Thomson	SP60	ESA_QCA990909T_C	ESA_QCA990909S_C
SGS-Thomson	SP100V	ESA_QCA9909010T_C	ESA_QCA9909010S_C
SGS-Thomson	SP200V	ESA_QCA9909011T_C	ESA_QCA9909011S_C
Siemens	SPP1N60S5	ESA_QCA9909012T_C	ESA_QCA9909012S_C
Philips	BUK7508-55	ESA_QCA9909013T_C	ESA_QCA9909013S_C
Harris	HUF75639P3	ESA_QCA9909014T_C	ESA_QCA9909014S_C

	SEE TEST REPORT HRX/99.4597		Rev. -	PAGE 5 ISSUE 1 July 2, 1999
	Part Type :	BUK456-200A	Manufacturer	Philips

II. INTRODUCTION

This report presents the results of a heavy ion Single Event Effects (SEEs) test program carried out on BUK456-200A N-Channel Power MOSFET from Philips.

Devices were tested at the European Heavy Ion Irradiation Facility (HIF) at Cyclone, Université Catholique de Louvain, Belgium.

This work was performed for ESA/ESTEC under ESA Contract No 13413/98/NL/MV dated 25/01/99

III. DOCUMENTS

III.1 APPLICABLE DOCUMENTS

AD1. Hirex Engineering proposal ref. HRX/98.3475 Issue 1, "Radiation Evaluation of Power MOS Devices from Different European Manufacturers"

AD2. ESA memorandum Appendix 1 to ESTEC/Contract No 13413/NL/MV

III.2 REFERENCE DOCUMENTS

RD1. Philips data sheet

RD2. Single Event Effects Test method and Guidelines ESA/SCC basic specification No 25100

RD3. The Heavy Ion Irradiation Facility at CYCLONE, UCL document, Centre de Recherches du Cyclotron (IEEE NSREC'96, Workshop Record, Indian Wells, California, 1996)

	SEE TEST REPORT HRX/99.4597		Rev. -	PAGE 6 ISSUE 1 July 2, 1999
	Part Type :	BUK456-200A	Manufacturer	Philips

IV. DEVICE INFORMATION

IV.1 DEVICE DESCRIPTION

N-Channel Power MOSFET, 200 Volts, 20 A encapsulated in TO-220AB package

IV.2 PROCUREMENT OF TEST SAMPLES

Delivered by ESA

IV.3 PREPARATION OF SAMPLES

Devices have been opened by chemical etch by Hirex Lab.

IV.4 SAMPLES CHECK OUT

A functional test sequence has been performed on opened samples to check that devices have not been degraded by the opening operation.

IV.5 DEVICE MARKING

Device marking is provided in Figure 1



Figure 1 – Device marking

Technology : -

Die metallization : Aluminum

Die dimensions (approximately, mm²) : 4,5 x 4,5

Further details on die description are provided in "Comparative Description and Analysis of Various Power MOSFETs", ESA document ref. ESA_QCA9909015_C (Hirex ref. HRX/99.4775) / ESA Contract No 13413/98/NL/MV dated 25/01/99.

	SEE TEST REPORT HRX/99.4597		Rev. -	PAGE 7 ISSUE 1 July 2, 1999
	Part Type :	BUK456-200A	Manufacturer	Philips

V. DEVICE TEST DEFINITION

V.1 PREPARATION OF TEST HARDWARE AND PROGRAM

Overall device emulation, SEE, data storage and processing were implemented using an in-house test hardware and application specific test boards.

The generic in-house test equipment is driven by a PC computer through a RS232 line. All power supplies and input signals are delivered and monitored by the in-house equipment which also stores in its memory the output data from the device throughout the specific test board.

The application specific test board allowed to interface the standard test hardware with the device under test, in order to correctly emulate the relevant part, to record all the different type of errors during the irradiation and to set output signal for processing and storage by the standard test equipment.

At the end of each test run, data are transferred to the PC computer through the RS232 link for storage on hard disk or floppies.

V.2 GENERIC TEST SET-UP

Generic device test set-up is presented in Figure 2.

This set-up is constituted of the following units:

- A PC computer (to configure and interface with the test system and store the data),
- An electronic rack with the instrumentation functions provided by a set of electronic modules,
- A mother board under vacuum which allows for the sequential test of up to 10 devices.
- A digital oscilloscope to store analog SEE waveform

SEE Test functional diagram is shown in Figure 3.

V.2.1 Mother board description (Ref. IL140A)

The motherboard acts as a standard interface between each DUT test board and the control unit :

For each slot, the following signals can be considered:

- 4 inputs signals
 - Drain Source programmable power supply
 - Gate Source programmable power supply
 - Simulation signal
 - Heater control signal
 - 1 output signal
 - 1 fast analog output signal
- IL140 board has been designed to comply with both PSI and Louvain test facilities .
 - Each device needs a dedicated plug-in test board compatible with IL140 mother board.
 - The number of slots is limited to 10: Up to 10 TO220 DUT test boards can be attached or up to 5 TO3 DUT test boards.
 - Operation is multiplexed and only one slot is powered at one time.

	SEE TEST REPORT HRX/99.4597		Rev. -	PAGE 8 ISSUE 1 July 2, 1999
	Part Type :	BUK456-200A	Manufacturer	Philips

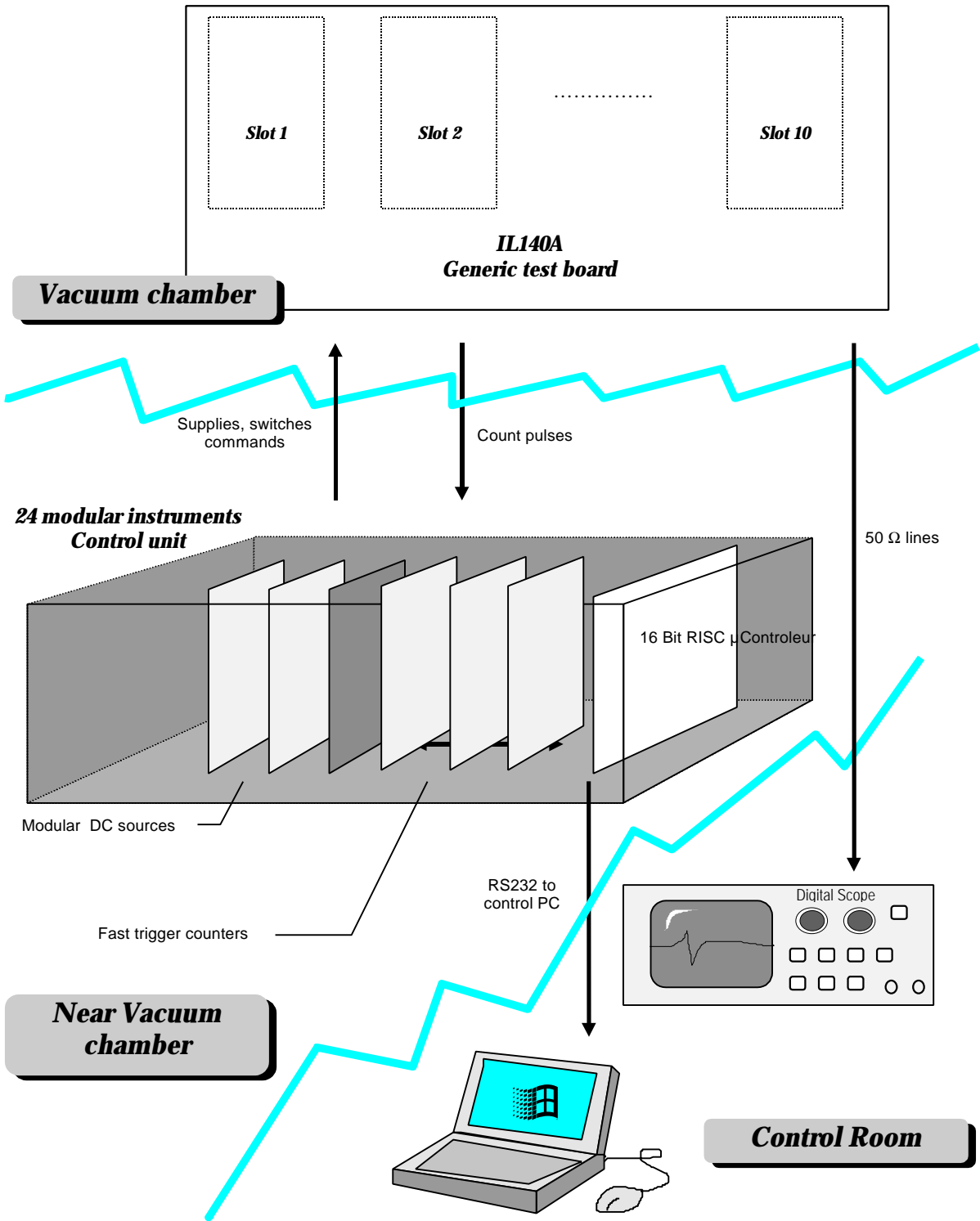

Figure 2 - Generic Test Set-up

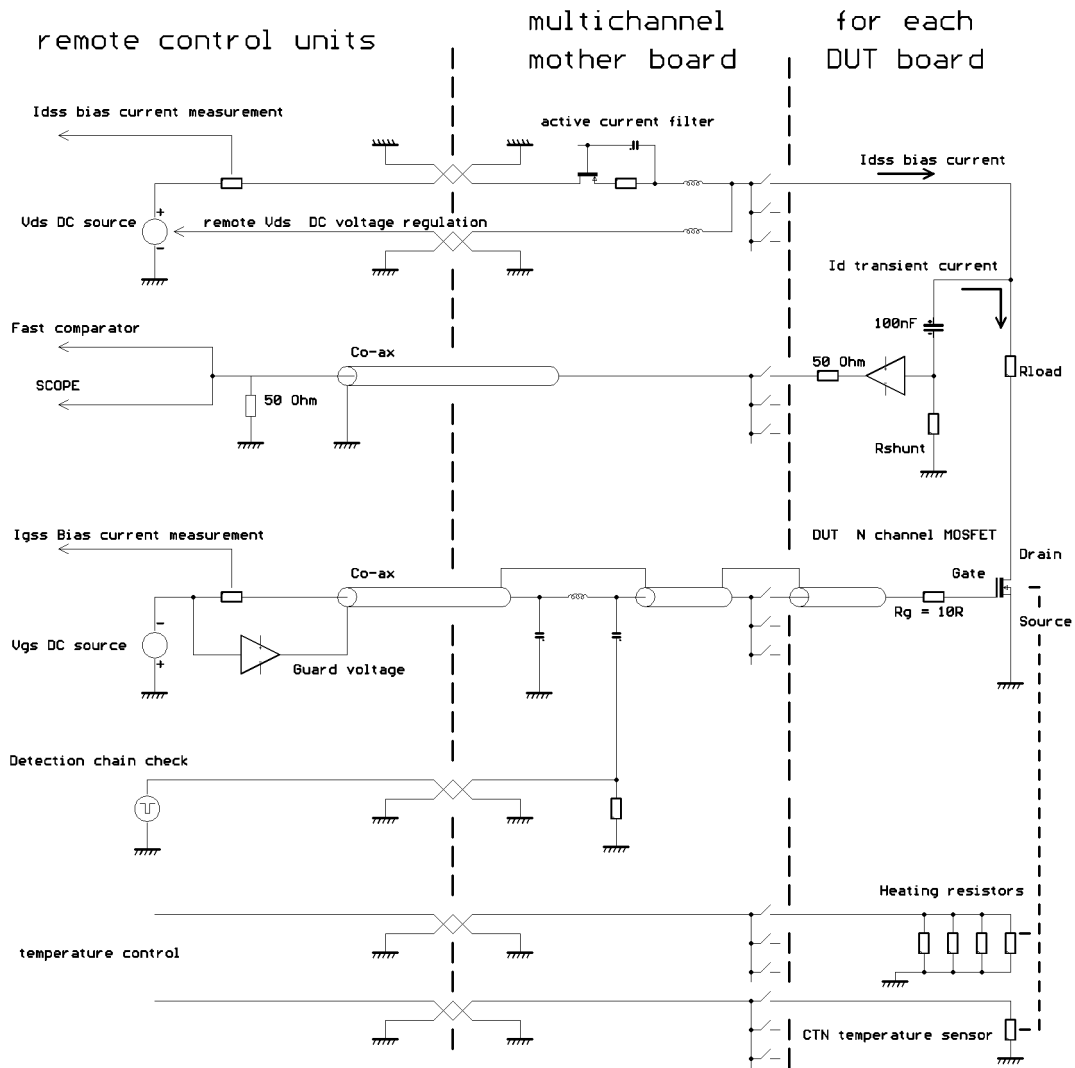

Figure 3 – Functional diagram for SEE Test

V.2.2 DUT Test board description

The device under test is mounted on a specific PCB board support which again is connected to the motherboard.

Two different DUT boards have been designed which can be fitted with either a TO2xx plastic package device or with a TO3 metal package device.

On each individual DUT board, a limiting current serie resistance and a shunt resistor are mounted for SEB pulse measurement.

To prevent the destructive burn-out of the DUT when the parasitic Bipolar Junction transistor (BJT) is triggered on by a strike, the DUT Drain is biased with a capacitor and a limiting current resistor mounted on each DUT board. This is to limit the amount of energy available as well as the maximum transient current value.

For testing at elevated temperature, each board is equipped with surface mount heating resistors plus a CTN thermistor for temperature control.

V.3 TEST CONFIGURATION

Test set-up which has been used for the present test report, allows for the detection of both Single Event Burn-out (SEB) and Single Event Gate Rupture (SEGR) effects

V.3.1 Single Event burnout (SEB)

SEB can be observed with the MOSFET in the off mode.

To get non destructive SEBs, selected test principle was to limit as much as possible the energy which could flow into the DUT when the parasitic bipolar transistor enters second breakdown.

To achieve this goal, a resistor R_{load} (see Figure 3) in serie with the DUT drain limits the current which can flow from the bias circuit (capacitor of 100nF, see Figure 3). In that case the only available energy which can flow into the DUT without any external current limitation is the one stored into the output DUT capacitance C_{DS} .

The equivalent circuit when an SEB is triggered is shown in Figure 4.

Observation of VDS transients is done at R_{shunt} which form a resistor divider with R_{load} .

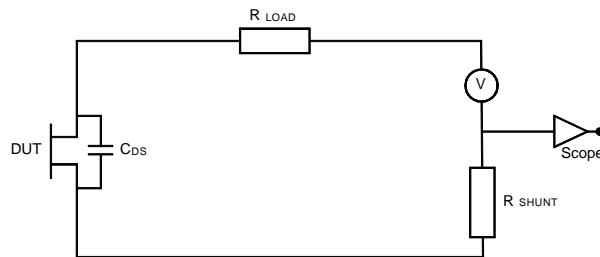

Figure 4 – Equivalent circuit for SEB including the parasitic capacitor of the MOSFET.

Actual resistor values for the test results presented in this report are shown in the Table 1 here below.

Symbol	Value
R_{load}	5,1 kohms
R_{Shunt}	25 ohms

Table 1 – Test circuit resistor values

Events are counted thanks to a programmable threshold comparator of 50MHz bandwidth. Moreover the monitoring of changes in the leakage dc current I_{dss} will allow to check for eventual permanent degradation.

Temperature effect may be evaluated as each DUT single board is provided with surface mount heating resistors and a thermistor mounted on the back side of the board, which give the ability of testing at elevated temperature.

	SEE TEST REPORT HRX/99.4597		Rev. -	PAGE 11 ISSUE 1 July 2, 1999
	Part Type :	BUK456-200A	Manufacturer	Philips

V.3.2 Single Event Gate Rupture (SEGR)

SEGR is a destructive effect which can be observed with the MOSFET in the off mode. Monitoring of the IGSS current allows for the detection of a SEGR which corresponds to a permanent degradation of the gate current.

This requires the measurement of μ amp current amplitude under high impedance. Test board design is compatible with the accelerator environment by the use of a complete guard ring.

Fluence is recorded during each run by monitoring with a modular counter, the TTL signal delivered by an on-line Beam Detector. Information on the reached fluence at the time of an eventual SEGR occurrence can then be retrieved by analysis of the run data.

	SEE TEST REPORT HRX/99.4597		Rev. -	PAGE 12 ISSUE 1 July 2, 1999
	Part Type :	BUK456-200A	Manufacturer	Philips

VI. TEST FACILITIES

VI.1 HEAVY IONS

Test at the cyclotron accelerator was performed at Université de Louvain (UCL) in Louvain la neuve (Belgium) under HIREX Engineering responsibility.

VI.1.1 Beam Source

In collaboration with the European Space Agency (ESA), the needed equipment for single events studies using heavy ions has been built and installed on the HIF beam line in the experimental hall of Louvain-la-Neuve cyclotron.

CYCLONE is a multi particle, variable energy, cyclotron capable of accelerating protons (up to 75 MeV), alpha particles and heavy ions. For the heavy ions, the covered energy range is between 0.6 MeV/AMU and 27.5 MeV/AMU. For these ions, the maximal energy can be determined by the formula :

$$110 Q^2/M$$

where Q is the ion charge state, and M is the mass in Atomic Mass Units.

The heavy ions are produced in a double stage Electron Cyclotron Resonance (ECR) source. Such a source allows to produce highly charged ions and ion "cocktails". These are composed of ions with the same or very close M/Q ratios. The cocktail ions are injected in the cyclotron, accelerated at the same time and extracted separately by a fine tuning of the magnetic field or a slight changing of the RF frequency. This method is very convenient for a quick change of ion (in a few minutes) which is equivalent to a LET variation.

VI.1.2 Beam Set-up

VI.1.2.1 Ion Beam Selection

The LET range was obtained by changing the ion species and incident energy and changing the angle of incidence between the beam and the chip.

For each run, information on the beam characteristics is provided in Table 2.

VI.1.2.2 Flux Range

For each run, the averaged flux value is provided in Table 2.

VI.1.2.3 Particle Fluence Levels

Fluence level was comprised between few x10E4 and 5 x10E5 ions/cm²

VI.1.2.4 Dosimetry

The current UCL Cyclotron dosimetry system and procedures were used.

VI.1.2.5 Accumulated Total Dose

For each run, the computed equivalent cumulated doses received by the DUT sample, is provided here below:

S/N	Dose (rads)
#001	6,22 E 2
#002	5,12 E 2

VI.1.2.6 Test Temperature Range

All the tests performed were conducted at ambient temperature.

	SEE TEST REPORT HRX/99.4597		Rev. -	PAGE 13 ISSUE 1 July 2, 1999
	Part Type :	BUK456-200A	Manufacturer	Philips

VII. HEAVY IONS RESULTS

VII.1 BUK456-200A TEST RESULTS

Krypton and Argon ions have been used with respective LETs of 34 and 14.1 MeV/mg/cm². Results per run are presented in Table 2.

Run A047 performed with a tilt angle of 30°, confirms that worst case corresponds to normal incidence.

Main outcomes can then be summarized as follows :

With Krypton (34 MeV/mg/cm²) and device biased with a fixed Gate Source Voltage (VGS) of -2V :

- Devices are SEB free when VDSS. does not exceed 25% of maximum rating.
- Devices are not sensitive to SEGR (limit of the present test was 50% of VDSS)

With Argon (14.1 MeV/mg/cm²) and device biased with a fixed Gate Source Voltage (VGS) of -2V :

- Devices are SEB free when VDSS does not exceed 55 % of maximum rating.
- Devices are not sensitive to SEGR (limit of the present test was 65% of VDSS).

With Argon, when devices are tested at a VDSS rating of 60%, the maximum gate source voltage which can be applied without occurrence of SEGR event is -15V (limit of the present test).

VII.2 TYPICAL SEB WAVEFORM

Figure 5 show a typical example obtained with a 100V transistor. In this figure, voltage variation across R_{shunt} can be observed for a SEB pulse waveform at two rated V_{DS} conditions, 60V and 70V. The superposition of the simulation pulse (observed at R_{shunt}) which consist to turn on the DUT allows to compare in each case, which part of the circuit is involved:

- In the SEB case, it can be seen that drain source voltage drops to zero in a very short time, then once the energy stored in the output DUT capacitance is dissipated, the current limitation provided by R_{load} allows for leaving the burn-out sustaining condition and DUT output capacitance start to reload with a current limited by R_{load}.
The very high dV/dt (> 10 000V/μs) induce a peak current greater than 2 A, which discharge the internal C_{DS} DUT capacitor in a few ns.
- In the case of simulation pulse, once the DUT is switched on, the supply current which flows into the DUT is limited by R_{load}.

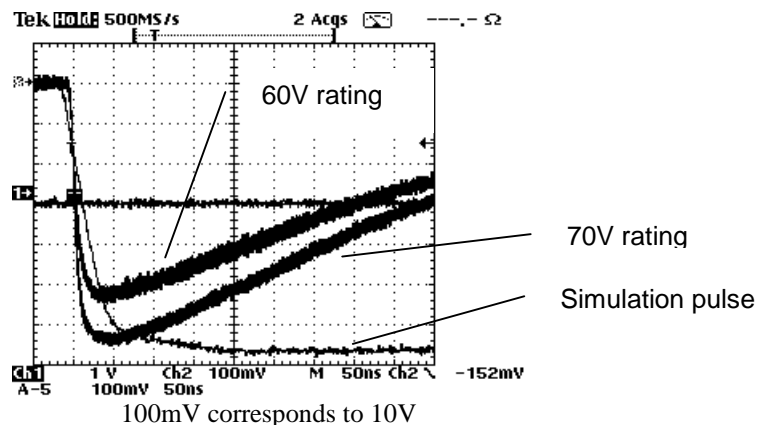



Figure 5 – Example of non destructive SEBs observed on a 100V transistor at 60V and 70V Vds ratings

	SEE TEST REPORT HRX/99.4597		Rev. -	PAGE 14 ISSUE 1 July 2, 1999
	Part Type :	BUK456-200A	Manufacturer	Philips

VIII. CONCLUSION

SEU test have been conducted on BUK456-200A N-channel Power MOSFET from Philips, using the heavy ions available at the European Heavy Ion Irradiation Facility (HIF), at Cyclone, Université Catholique de Louvain, Belgium.

With Krypton (34 MeV/mg/cm²) and device biased with a fixed Gate Source Voltage (VGS) of -2V :

- Devices are SEB free when VDSS. does not exceed 25% of maximum rating.
- Devices are not sensitive to SEGR (limit of the present test was 50% of VDSS)

With Argon (14.1 MeV/mg/cm²) and device biased with a fixed Gate Source Voltage (VGS) of -2V :

- Devices are SEB free when VDSS does not exceed 55 % of maximum rating.
- Devices are not sensitive to SEGR (limit of the present test was 65% of VDSS).

With Argon, when devices are tested at a VDSS rating of 60%, the maximum gate source voltage which can be applied without occurrence of SEGR event is -15V (limit of the present test).



SEE TEST REPORT

HRX/99.4597

Rev. -

PAGE 15

ISSUE 1

July 2, 1999

Part Type :

BUK456-200A

Manufacturer

Philips

Table 2 – Heavy Ion Test results on BUK456-200A N-Channel Power MOSFET from Philips :

Run #	Date	S/N	Ion	LETeff (MeV/mg/cm ²)	Angle (°)	T(°C) (°C)	VDS (V)	VGS (V)	%VDSS (%)	Fluence (p/cm ²)	Flux (p/cm ² /s)	Time (s)	SEB		SEGR		Comparator Threshold mV	Equivalent Pulse height V
													Nbr (-)	Sigma cm ²	Nbr (-)	Sigma cm ²		
VGS=-2V, Ion Krypton, LET =34 MeV/mg/cm ²																		
A042	09/01/99	1	84-Kr	34	0	25	50	-2	25%	100926	1097	92	0				-152	-31
A043	09/01/99	2	84-Kr	34	0	25	50	-2	25%	100661	1060	95	0				-152	-31
A041	09/01/99	1	84-Kr	34	0	25	60	-2	30%	100795	1186	85	6006	5,96E-02			-152	-31
A044	09/01/99	2	84-Kr	34	0	25	60	-2	30%	100381	1128	89	5666	5,64E-02			-152	-31
A040	09/01/99	1	84-Kr	34	0	25	80	-2	40%	100380	1103	91	8093	8,06E-02			-152	-31
A045	09/01/99	2	84-Kr	34	0	25	80	-2	40%	101080	1075	94	8336	8,25E-02			-152	-31
A046	09/01/99	2	84-Kr	34	0	25	80	-2	40%	30629	1134	27	2527	8,25E-02			-152	-31
A038	09/01/99	1	84-Kr	34	0	25	100	-2	50%	26906	1121	24	1559	5,79E-02			-152	-31
A039	09/01/99	1	84-Kr	34	0	25	100	-2	50%	20153	1120	18	1823	9,05E-02			-152	-31
A048	09/01/99	2	84-Kr	34	0	25	100	-2	50%	30314	1213	25	2766	9,12E-02			-152	-31
VGS=-2V, Ion Krypton, LET =34 MeV/mg/cm ² , tilt angle =30°																		
A047	09/01/99	2	84-Kr	39,26	30	25	80	-2	40%	30239	975	31	1873	6,19E-02			-152	-31
VGS=-2V, Ion Argon, LET =14,1 MeV/mg/cm ²																		
A192	10/01/99	1	40-Ar	14,1	0	25	100	-2	50%	103148	3327	31	0				-152	-31
A194	10/01/99	1	40-Ar	14,1	0	25	110	-2	55%	102008	4080	25	1	9,80E-06			-152	-31
A202	10/01/99	2	40-Ar	14,1	0	25	110	-2	55%	106027	6237	17	0				-152	-31
A193	10/01/99	1	40-Ar	14,1	0	25	120	-2	60%	102877	4115	25	59	5,74E-04			-152	-31
A199	10/01/99	2	40-Ar	14,1	0	25	120	-2	60%	100964	5939	17	30	2,97E-04			-152	-31
A195	10/01/99	1	40-Ar	14,1	0	25	130	-2	65%	102401	2844	36	3450	3,37E-02			-152	-31
A201	10/01/99	2	40-Ar	14,1	0	25	130	-2	65%	104240	6132	17	2267	2,17E-02			-152	-31
VGS=-5V, Ion Argon, LET =14,1 MeV/mg/cm ²																		
A196	10/01/99	1	40-Ar	14,1	0	25	120	-5	60%	502264	3488	144	119	2,37E-04			-152	-31
VGS=-10V, Ion Argon, LET =14,1 MeV/mg/cm ²																		
A197	10/01/99	1	40-Ar	14,1	0	25	120	-10	60%	503558	5138	98	56	1,11E-04			-152	-31
A203	10/01/99	2	40-Ar	14,1	0	25	120	-10	60%	500281	5685	88	17	3,40E-05			-152	-31
VGS=-15V, Ion Argon, LET =14,1 MeV/mg/cm ²																		
A198	10/01/99	1	40-Ar	14,1	0	25	120	-15	60%	500505	6336	79	29	5,79E-05			-152	-31
A204	10/01/99	2	40-Ar	14,1	0	25	120	-15	60%	500194	5210	96	8	1,60E-05			-152	-31